

OPERATING INSTRUCTION

LED CEILING/WALL LUMINAIRE



Chamaeleon Deco Standard-Charcoal black



IP
Rating



Year
Warranty



Motion
Sensor



Daylight
Sensor



Ceiling
Mount



Wall
Mount



APPLICATION

This is an indoor & outdoor LED ceiling/wall mounted luminaire.

- Houses
- Offices
- Retail
- Schools
- Hotels
- Hospitals
- Airports

MAIN TECHNICAL DATA

Input: AC 220-240V 50Hz

Working temperature: -20°C to +50°

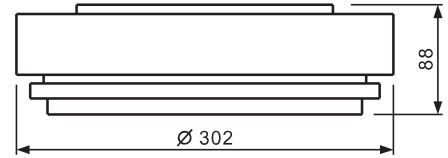

CAUTION

1. The product must be installed by a licensed electrician in accordance with the latest AS3000 wiring regulations and power supply must be isolated before installation.
2. Don't touch LED while installing or maintaining.
3. Light must be operated within its specified operating parameters and in accordance with our warranty requirements. These documents are available on our website.

TECHNICAL INFORMATION

Code	Input Voltage	LED Qty	Input Power	Lumen	Sensor
D-CHAM-C-CB	220-240V~ 50Hz	200	21W	1750 Lm	Yes

MICROWAVE SENSOR DETECTION RANGE

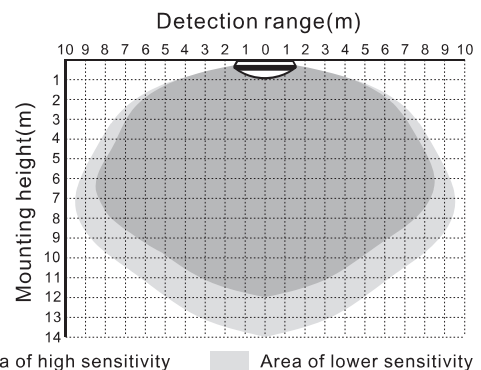

	Wall mount	Ceiling mount
Suggested Installation height	1-1.8m	2.5-6m
Detection range	Up to 6m	Up to 8m
Detection angle:	30°-150°	360°
Standard detection range setting	100% with options to decrease to 75, 50, 25 or 10%	

PARAMETER SETTING OF MICROWAVE SENSOR

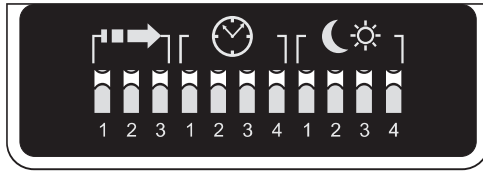



• Detection range setting(sensitivity)

This determines the effective range of the motion detector and is set by DIP switches at the sensor itself, refer to figure. Note that reducing the sensitivity will also narrow the detection range.

The following settings are available:

- I – Detection range 100%
- II – Detection range 75%
- III – Detection range 50%
- IV – Detection range 25%
- V – Detection range 10%

	Detection Area			
	1	2	3	
I	●	●	●	100%
II	○	●	●	75%
III	●	○	●	50%
IV	●	●	○	25%
V	○	○	○	10%

on 
 off 





• Time setting

This determines the time the fitting remains at 100% level on motion detection and is set with DIP switches at the sensor itself, refer to figure.

The following settings are available:

- I – 5s
- II – 30s
- III – 1 minutes
- IV – 5 minutes
- V – 15 minutes
- VI – 30 minutes

	Hold Time				
	1	2	3	4	
I	●	●	●	●	5s
II	○	●	●	●	30s
III	●	○	●	●	1min
IV	●	●	○	●	5min
V	●	●	●	○	15min
VI	○	○	○	○	30min

on 
 off 





• Light control setting (can only be used when standby is set to 0% - see page 4)

This setting allows the motion sensor to switch the unit on when ambient light is below the set point. **This setting can only be used if the standby is set to 0% (see page 4). If the standby is set to 20% this has to be set to 'Photocell Disable. When using the photocell function ensure the sensor cannot be influenced by other light sources.**

The following settings are available:

- I – 2Lux darkness operation only
- II – 5Lux twilight operation
- III – 10Lux twilight operation
- IV – 30Lux daylight operation
- V – 50Lux daylight operation
- VI – Photocell Disable

	Daylight Sensor				
	1	2	3	4	
I	●	●	●	●	2Lux
II	○	●	●	●	5Lux
III	●	○	●	●	10Lux
IV	●	●	○	●	30Lux
V	●	●	●	○	50Lux
VI	○	○	○	○	Disable

on 
 off 

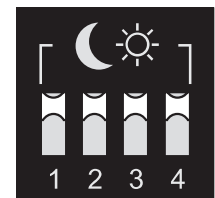

MOUNTING

1. Disassemble the diffuser .
2. Open the LED panel.
3. Pull in the power cord through the gasket.
4. Fix the base on the surface with screws .
5. Connect the power cord on the terminal correctly.

 (Caution:Earth cable must be connected firmly.)
6. Close the LED panel.
7. Assemble the diffuser.

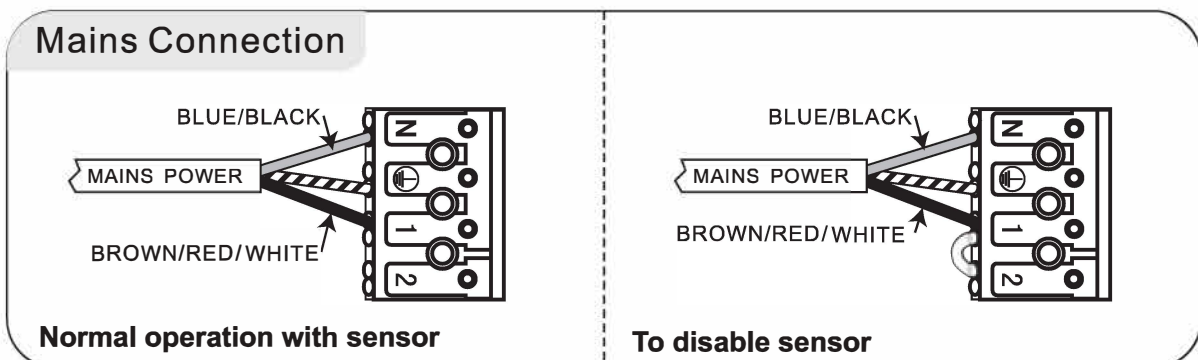
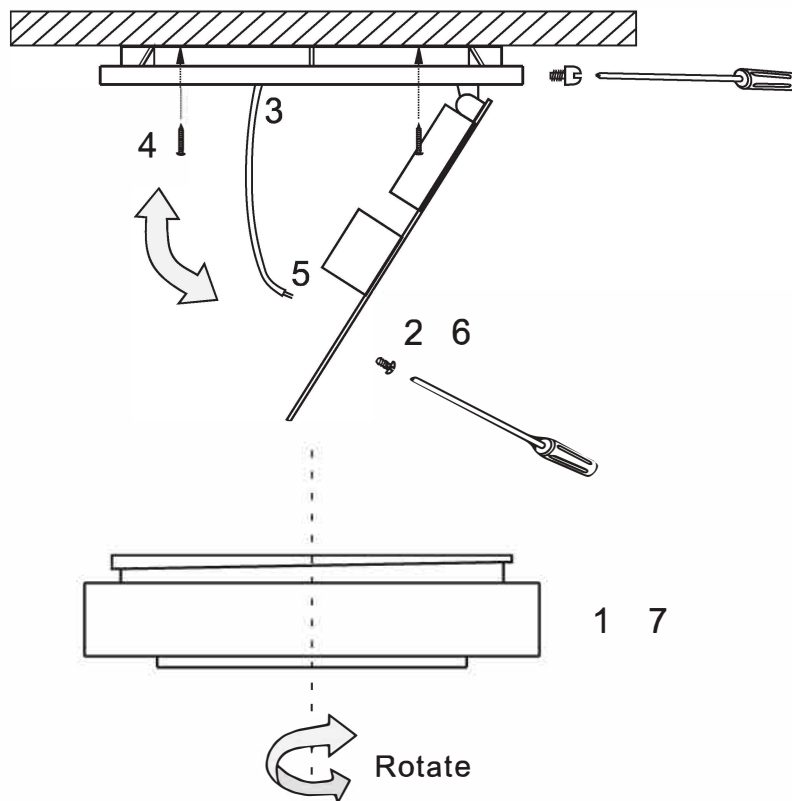

Optional functions by changing LED driver wiring

Option 1: When movement is detected, the light switches on. Once movement ceases, the light will switch off, after the selected time.

Option 2: Light is normally on at 20% standby. When movement is detected, the light switches to full output. Once movement ceases, the light will switch back to 20%, after the selected time.

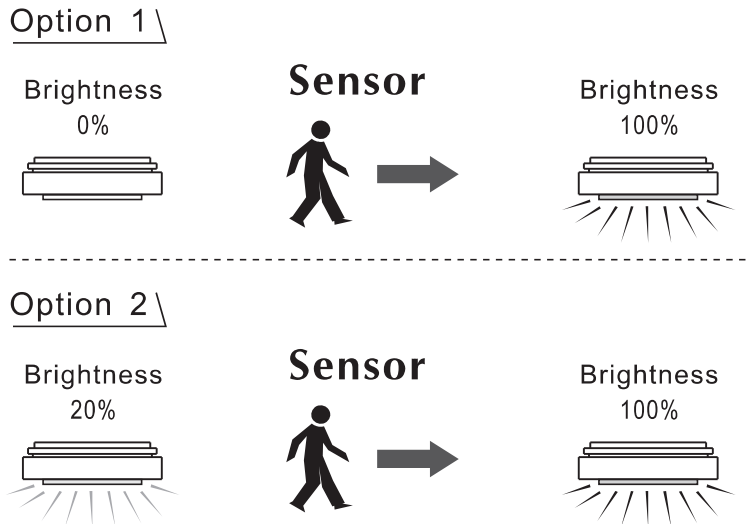

WIRING OPTIONS OF LED DRIVER TO SET STANDBY LEVEL

The cable connection allows for either a 0% or 20% (Recommended setting) standby light output.

Option 1: 0% standby light output

To change from 20% to 0 standby light output, change over the Brown & White input wires, listed as Nos 1 & 2 in diagram on LED driver (see below).

Option 2: 20% standby light output (Recommended setting)

Important Note: To avoid leaving a space in darkness, Enlighten recommends using Option 2. **20% light output on standby.** Please check driver wires are connected as per Option 2 in the image below to achieve 20% light output in standby mode.

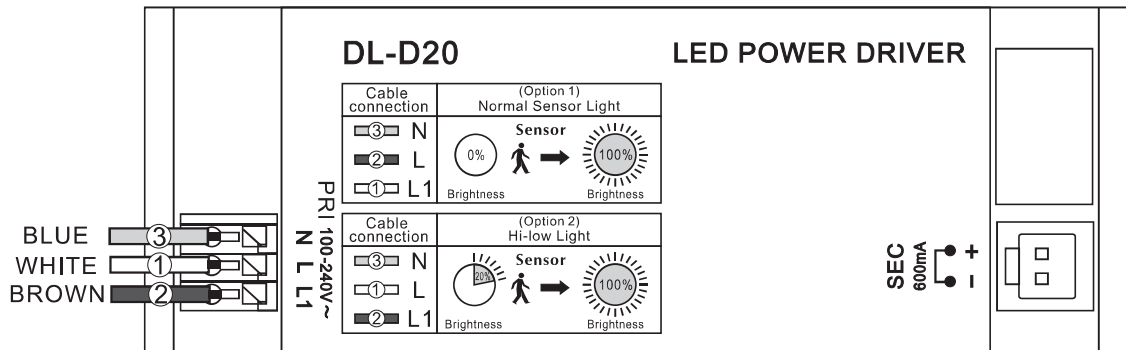

MAINTENANCE

1. Isolate the mains power first.
2. Don't touch LED while maintaining or cleaning.
3. Don't use chemical reagent to clean lamp.

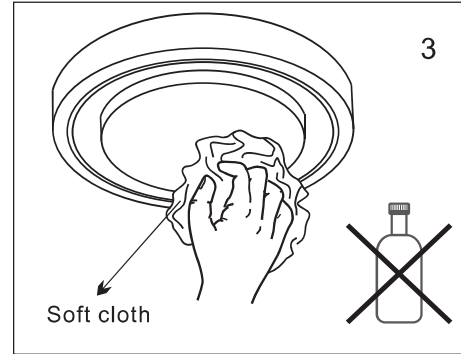
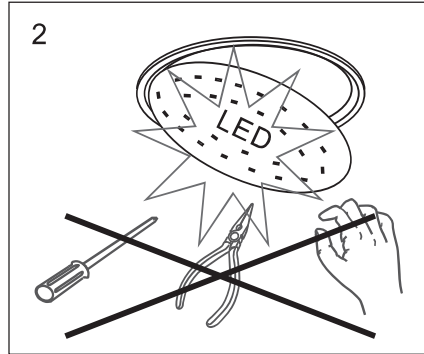
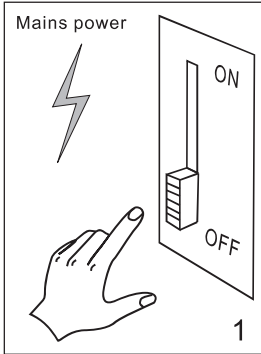

Environmental protection: Waste electrical products should not be disposed of with household waste. Please recycle where facilities exist. Check with your local authority or retailer for recycling advice.

