

# USER MANUAL

## Diagnostic Thermal Camera

Models TG267, TG297, and TG165-X

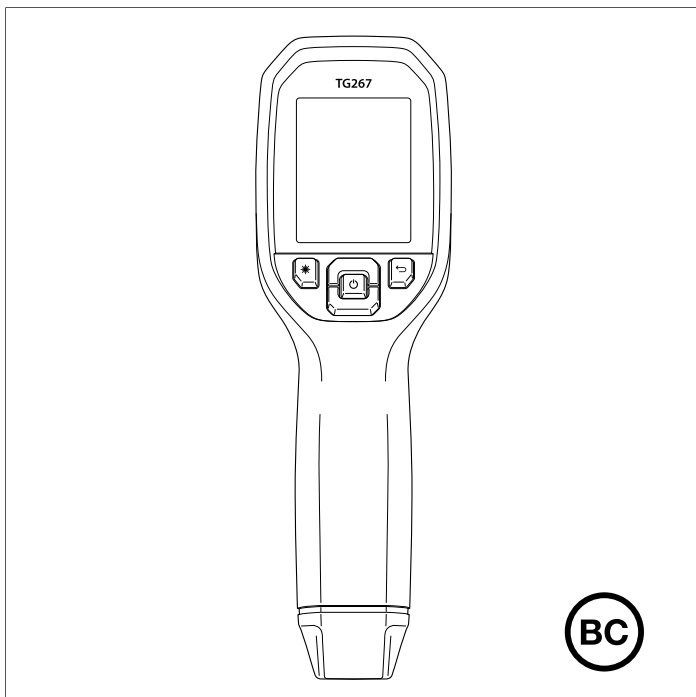





---

# **USER MANUAL**

## **Diagnostic Thermal Camera**



# Table of contents

---

<b>1</b>	<b>Advisories</b> .....	<b>1</b>
1.1	Copyright.....	1
1.2	Quality Assurance .....	1
1.3	Documentation .....	1
1.4	Disposal of Electronic Waste.....	1
<b>2</b>	<b>Introduction</b> .....	<b>2</b>
<b>3</b>	<b>Safety</b> .....	<b>3</b>
3.1	Safety Warnings and Cautions.....	3
<b>4</b>	<b>Description</b> .....	<b>4</b>
4.1	Product Description.....	4
4.2	Control Button Descriptions .....	5
4.3	Display Description .....	5
<b>5</b>	<b>Operation</b> .....	<b>7</b>
5.1	Camera Power .....	7
5.2	IR Camera and Thermometer.....	7
5.3	High Temperature Switch (TG297).....	8
5.4	Type-K Thermocouple Measurements (TG267).....	9
5.5	Visible Spectrum Camera.....	11
5.6	Capture, View, Transfer, Send, and Delete Camera Images.....	11
<b>6</b>	<b>Programming Menu System</b> .....	<b>12</b>
6.1	Menu System Basics.....	12
6.2	Main Menu.....	12
6.3	Settings Sub-Menu .....	14
<b>7</b>	<b>Bluetooth® Communication and FLIR Tools™</b> .....	<b>20</b>
7.1	Bluetooth® Communication Overview.....	20
7.2	Download the FLIR Tools™ Mobile App.....	20
7.3	Setting up the FLIR Tools™ Mobile App.....	20
7.4	Transmit Images via Bluetooth® .....	20
7.5	FCC Compliance .....	22
7.6	GITEKI Certified .....	23
<b>8</b>	<b>Field Firmware Updates</b> .....	<b>24</b>
8.1	System Firmware Update .....	24
<b>9</b>	<b>Maintenance</b> .....	<b>25</b>
9.1	Cleaning.....	25
9.2	Battery Considerations and Service.....	25

## Table of contents

---

	9.3	Reset the Camera.....	25
<b>10</b>		<b>Specifications.....</b>	<b>26</b>
	10.1	Imaging and Optical Specifications.....	26
	10.2	Detector Specifications.....	26
	10.3	Image Presentation Specifications.....	26
	10.4	Measurement Specifications.....	27
	10.5	Measurement Analysis Specifications.....	27
	10.6	Type-K specifications (TG267 only).....	27
	10.7	Configuration Specifications.....	28
	10.8	Image Storage Specifications.....	28
	10.9	Digital Camera Specifications.....	28
	10.10	Flashlight Specifications.....	28
	10.11	Laser Pointer Specifications.....	29
	10.12	Data Communication and Interface Specifications.....	29
	10.13	Rechargeable Battery Specifications.....	29
	10.14	Environmental Specifications.....	30
	10.15	Physical Specifications.....	31
	10.16	Included Equipment.....	31
<b>11</b>		<b>2–10 Extended Warranty.....</b>	<b>32</b>
<b>12</b>		<b>Customer Support.....</b>	<b>33</b>
	12.1	Corporate Headquarters.....	33

# 1 Advisories

---

## 1.1 Copyright

©2020 FLIR Systems, Inc. All rights reserved worldwide.

No parts of the software including source code may be reproduced, transmitted, transcribed or translated into any language or computer language in any form or by any means, electronic, magnetic, optical, manual or otherwise, without the prior written permission of FLIR Systems.

The documentation must not, in whole or part, be copied, photocopied, reproduced, translated or transmitted to any electronic medium or machine-readable form without prior consent, in writing, from FLIR Systems. Names and marks appearing on the products herein are either registered trademarks or trademarks of FLIR Systems and/or its subsidiaries. All other trademarks, trade names or company names referenced herein are used for identification only and are the property of their respective owners.

## 1.2 Quality Assurance

The Quality Management System under which these products are developed and manufactured has been certified in accordance with the ISO 9001 standard. FLIR Systems is committed to a policy of continuous development; therefore, we reserve the right to make changes and improvements on any of the products without prior notice.

## 1.3 Documentation

To access the latest manuals and notifications, go to the Download tab at: <https://support.flir.com>. It only takes a few minutes to register online. In the download area you will also find the latest releases of manuals for our other products, as well as manuals for our historical and obsolete products.

## 1.4 Disposal of Electronic Waste



As with most electronic products, this equipment must be disposed of in an environmentally friendly way, and in accordance with existing regulations for electronic waste. Please contact your FLIR Systems representative for more details.

# 2 Introduction

---

The FLIR TG267, TG297, and TG165–X are Diagnostic Thermal Cameras which combine non-contact temperature measurement and thermal imaging into one troubleshooting tool to help you quickly find the source of heat-related problems and spot potential faults.

The FLIR TG267 adds Type-K thermocouple contact temperature measurements.

The FLIR TG297 offers a high temperature range to 1030°C (1886°F).

Visit <https://support.flir.com/prodreg> to register your instrument and to extend the standard one-year warranty to the 2-10 Year Warranty.









## Features

- See beyond the limitations of single-spot IR thermometers with a 160 x 120 pixels (80 x 60 pixels, for TG165–X) true thermal imager (Lepton® microbolometer with integrated shutter)
- Visible spectrum 2M pixel digital camera
- Adjustable MSX® (Multi-Spectral Dynamic Imaging) adds key details from the visible spectrum camera to the IR image to help you diagnose problems
- 3 presets and 1 custom emissivity setting
- LED Work light
- Laser pointer and cross-hair display for easy targeting of measurement spot
- Type-K thermocouple contact measurements (TG267)
- High temperature lever switch (TG297) engages high temperature mode
- 4 GB internal memory for storing captured images
- USB–C connectivity for image transfer and charging
- Bluetooth® real-time remote temperature monitoring and camera image transmission to mobile devices (TG267, TG297 only)
- Easy to read 320 x 240 2.4" TFT colour LCD display
- Intuitive programming menu system translated in more than 21 languages
- IP54 enclosure (with top flap closed) protects from dirt, dust, and oil
- Rechargeable lithium battery
- Auto power off (APO), user adjustable
- Accessory mounting for tripods, extender poles, etc.



# 3 Safety

## 3.1 Safety Warnings and Cautions

	<b>WARNING</b>
<p>⚠ This symbol, adjacent to another symbol indicates the user must refer to the manual for further information.</p>	
	<b>WARNING</b>
<p>The instrument's IP54 rating is only in affect when the top flap (covering the USB-C and Thermocouple jacks) is completely sealed. Do not operate the instrument with the flap open, except for charging, PC interface, or Type-K thermocouple use.</p>	
	<b>CAUTION</b>
<p>Use of controls or adjustments or performance of procedures other than those specified herein may result in hazardous radiation exposure.</p>	
	<b>CAUTION</b>
<p>Use extreme caution when the Laser pointer is on.</p>	
	<b>CAUTION</b>
<p>Do not point the Laser beam toward anyone's eye or allow the beam to strike the eye from a reflective surface.</p>	
	<b>CAUTION</b>
<p>Do not use the Laser near explosive gases or in other potentially explosive areas.</p>	
	<b>CAUTION</b>
<p>Refer to the CAUTION statement label (shown below) for critical safety information.</p>	
	

# 4 Description

---



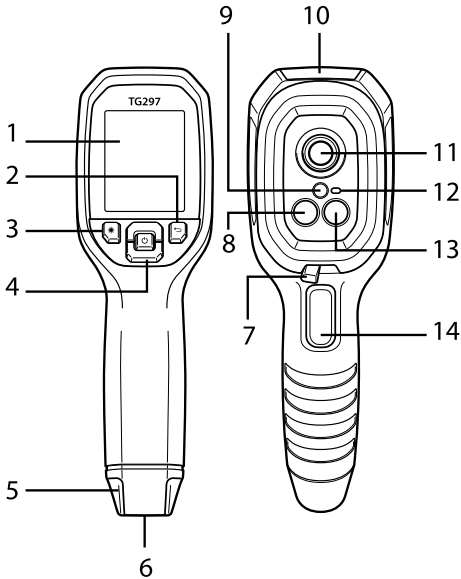

## 4.1 Product Description



**Figure 4.1** Imaging IR Thermometer Description (TG297 pictured)

1. Display area
2. Return button (to back up in the menu system)
3. Laser pointer button
4. Up/Down Navigation buttons and Power button (long press)/Menu button (short press)
5. Lanyard post
6. Accessory mount
7. High temperature filter switch (TG297)
8. Lepton® IR camera
9. Laser pointer with circular target-spot assist
10. USB-C and Thermocouple jack compartment
11. Spot thermal sensor
12. Work light (LED)
13. 2M pixel visible spectrum camera
14. Image capture trigger (also used to exit the menu system)

**4.2 Control Button Descriptions**

	Long press to power ON or OFF Short press to access the menu system
	Return button. Back out to previous screen in menus
	Press to scroll upward in the menus
	Press to scroll downward in the menus
	Press to activate the Laser pointer
<b>TRIGGER</b>	Pull trigger to capture camera image Pull trigger to exit the menu system

**4.3 Display Description**

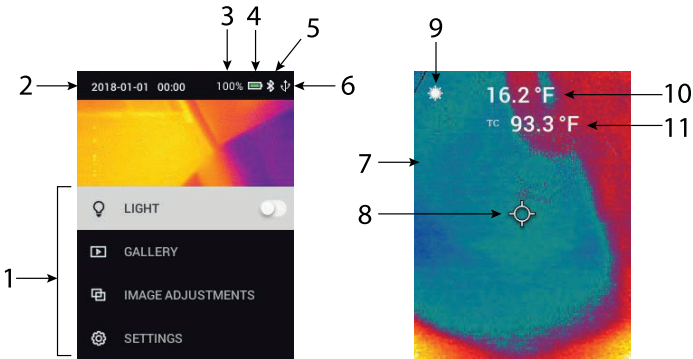

**Figure 4.2** Display Description

1. Menu area
2. Date and time
3. Battery status percentage
4. Battery status indicator
5. Bluetooth® active (TG267, TG297)
6. USB connection active

7. Camera image area
8. Center spot cross-hairs
9. Laser Pointer active
10. Center spot temperature measurement
11. Thermocouple measurement (TG267)

# 5 Operation

---

## 5.1 Camera Power

Power is supplied by a rechargeable lithium battery. Long press the power button (center) to switch the camera ON or OFF. If the camera does not power ON, charge the battery by connecting to an AC wall charger using the supplied USB-C cable. The USB-C jack is located in the top compartment. Do not use the camera while it is charging. When the top flap is closed, the camera is rated IP54 for encapsulation. See Section 9.2, *Battery Considerations and Service*, for more information.

The camera has an Auto Power OFF (APO) utility that switches it OFF automatically if no buttons are pressed for the duration of the selected APO time. Use the menu system (under *Device Settings*) To set the APO timer. See Section 6, *Programming Menu System*, for more information.

## 5.2 IR Camera and Thermometer

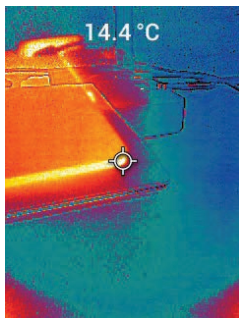

**Figure 5.1** Combined Thermal and Visible Image (MSX®)

1. Long press the power button to switch the camera ON.
2. If not already selected, choose the Thermal plus Visible Image mode in the menu system (under *Image Adjustments/Image Mode*). You can adjust the MSX® (Multi-Spectral Dynamic Imaging) alignment in the *Image Mode* menu (press MENU at the MSX® image option and use the arrows to make the adjustments; press MENU to confirm). Note that you can also adjust the alignment directly in the normal operating mode using the arrow buttons while viewing a Thermal Plus Visible image.
3. Point the camera toward the test area and scan as desired. View the camera image on the display.

4. Use the Laser pointer to accurately target a spot. Press the Laser pointer button to switch ON the Laser pointer. The camera's Laser pointer includes a circular spot indicating the area that is being monitored for temperature, utilizing DOE (Diffractive Optical Elements) technology. See the Laser pointer image example below in **Figure 5.2**. If the Laser beam does not appear when the button is pressed, check the menu system (under *Device Settings*) to ensure that the Laser is enabled.
5. Use the cross-hair icon for reference only when targeting measurement spots, as parallax errors affect targeting accuracy. If the cross-hairs are not shown, check the menu system (under *Measurement*) to ensure that the Center Spot (cross-hairs) function is enabled.
6. The temperature reading on the display represents the measurement of the targeted spot. See **Figure 5-1**.
7. The distance-to-spot ratio is 24:1 (TG267, TG165-X) or 30:1 (TG297) and the minimum target distance is 26 cm (10.2 in.).
8. To measure higher than 752°F (400°C) on the TG297 use the High Temperature Switch, see Section 5.3 below.
9. The TG267 and TG165-X do not include a high temperature filter, do NOT attempt to measure > 380°C (716°F) on the TG267 or > 300°C (572°F) on the TG165-X.
10. If a measurement is out of range, the display will show 'OL'.
11. To adjust the Emissivity, use the menu system (under *Measurement*).
12. To change the display color palette, use the menu system (under *Image Adjustments/colors*).



**Figure 5.2** Laser pointer with temperature measurement spot

## NOTE





The camera's reflected temperature setting is fixed at 77°F (25°C) and may differ from the actual reflected temperature of any given application.

### 5.3 High Temperature Switch (TG297)

1. To access the high temperature mode of the TG297, slide the lever to the right (to expose the red colour code).
2. The lever is located directly below the lens area and above the image capture trigger.

- When engaged, the high end of the temperature range ( $>752^{\circ}\text{F}$  [ $400^{\circ}\text{C}$ ]) is accessible.

#### 5.4 Type-K Thermocouple Measurements (TG267)

 <b>WARNING</b>
Note the temperature range limit printed on the thermocouple connector (or verify the range with the manufacturer). The supplied probe cannot be used to measure temperature through the entire display range listed in the specification section of this manual; measuring temperature beyond the range printed on the thermocouple connector can damage the probe and the TG267. If the thermocouple does not include a range label, please contact FLIR technical support.
 <b>WARNING</b>
To avoid electrical shock, do not use this instrument when working near voltages $> 24\text{V}$ AC/DC. Do not allow the thermocouple to touch live circuitry.
 <b>WARNING</b>
To avoid damage and burns, do not make temperature measurements in microwave ovens.
 <b>CAUTION</b>
Repeated flexing can break the thermocouple leads. To prolong lead life, avoid sharp bends, especially near the connector.

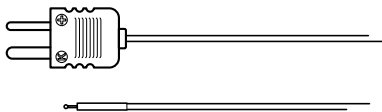

**Figure 5.3** Supplied Type-K Thermocouple

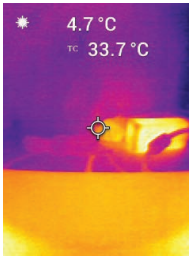

**Figure 5.4** Thermocouple temperature readout (33.7°C, in this example)

1. If necessary, enable the thermocouple mode in the menu system (under *Measurement*). The thermocouple is enabled when the 'TC' label is shown on the display.
2. Connect a Type-K thermocouple sub-miniature plug (see **Figure 5.3**) to the jack in the top compartment.
3. Touch the thermocouple probe tip to the surface under test or hold it in air. Read the temperature value on the display next to the 'TC' label, see **Figure 5-4**.
4. Go to *General Settings* in the menu system to select °C or °F temperature units.
5. If the thermocouple is not connected when the Type-K mode is selected, the display will show dashes in place of a reading. If the measurement is out of range, the display will show 'OL'.
6. To find the optimum emissivity setting for a given surface, take an IR temperature measurement and then take a Type-K measurement. Adjust the emissivity until the IR measurement value equals the Type-K measurement value. Now the emissivity is optimised. Emissivity can be set in the menu system (under *Measurement*).



---

## 5.5 Visible Spectrum Camera

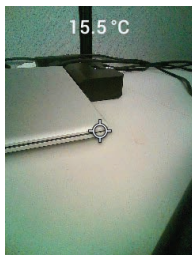

**Figure 5.5** Visible Spectrum Digital Camera Image

1. Long press the power button to switch the camera ON.
2. Select the Visible Image mode in the menu system (under *Image Adjustments/Image Mode*).
3. Point the camera toward the test area and scan as desired.
4. View the image on the display, see **Figure 5–5**. Pull the image capture trigger to save an image. Refer to Section 5.6, *Capturing and Working with Images*, (next) for more information.

## 5.6 Capture, View, Transfer, Send, and Delete Camera Images

1. To capture a camera image to the camera's internal memory, pull and release the trigger. Note that an image cannot be saved if a USB cable is connected to the camera.
2. After a successful image capture, a display confirmation will briefly appear showing the image filename.
3. To view images on the camera display, access the *Gallery* mode in the main menu. In the Gallery, scroll through the stored images with the arrows and open an image with the MENU button.
4. To delete images, select the DELETE or DELETE ALL FILES command to erase the selected image or all of the stored images.
5. To transfer images to a PC, connect the camera to a PC using the supplied USB-C cable. The USB jack is located at the top of the camera, under the flap. Once connected to the PC you can use the camera as you would any external storage drive. Note: *Device is not 100% compatible with Mac OS, please do not format the camera's internal memory via Mac OS.*
6. To transmit images via Bluetooth®, see Section 7, *Bluetooth® Communication and FLIR Tools™*. Note that the TG165–X does not include Bluetooth® capability.

# 6 Programming Menu System

---

## 6.1 Menu System Basics

Short press the MENU button to access the menu system. Use the MENU button to switch settings ON or OFF, use the Return button to move to the previous screen, and use the arrows to scroll. The MENU button is used in some cases to confirm settings. Use the trigger to exit the menu system.

## 6.2 Main Menu

- **LIGHT:** Short press MENU to switch the Work light ON or OFF.

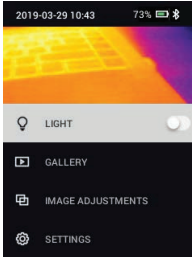

- **GALLERY:** Press MENU to access the stored images. Use the arrow buttons to scroll through the stored images and use the MENU button to open an image. Press MENU at an opened image to see the SEND/CANCEL/DELETE/DELETE ALL FILES menu. Select SEND to transmit the selected image to a paired mobile device (see Section 7, *Bluetooth® Communication and FLIR Tools™*, for more information. Note that the TG165-X does not include Bluetooth® capability).

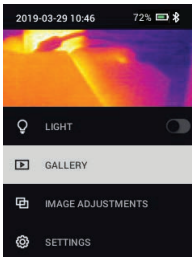

- **IMAGE ADJUSTMENTS:** Press MENU to access IMAGE MODES (including MSX® alignment) and colors, see below:

1. Image Modes: Press MENU at IMAGE MODES and use the arrow buttons to select VISIBLE IMAGE or THERMAL PLUS VISIBLE IMAGE (MSX®).

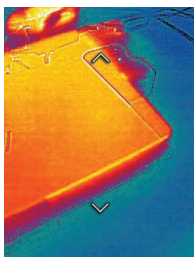
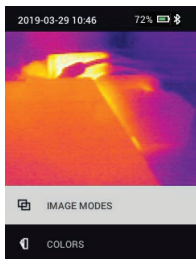

2. MSX® Alignment: Adjust the alignment (so that the thermal image and the visible image line up accurately) as follows: While viewing the THERMAL PLUS VISIBLE IMAGE screen in the menu, press MENU to access the MSX® adjustment screen and then use the arrow buttons to adjust the alignment. Press MENU to confirm. Note that you can also adjust the alignment directly in the normal operating mode using the arrow buttons while viewing a Thermal Plus Visible image.

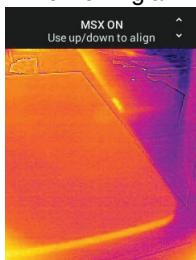

- Colors: Press MENU at the colors menu and use the arrow buttons to select a color palette: Iron, Rainbow, White hot, Black hot, Arctic, or Lava. Press MENU to confirm selection.

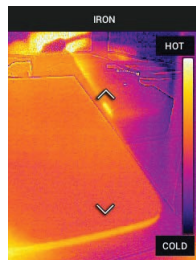
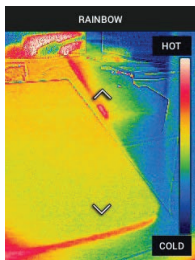
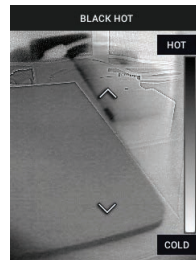
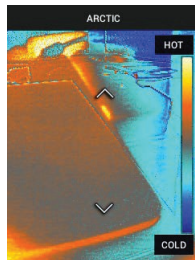
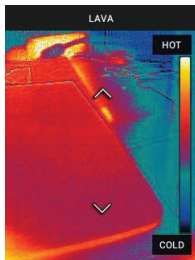
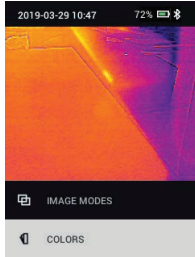

- **SETTINGS:** Press MENU to access the Settings sub-menu (see below):

### 6.3 Settings Sub-Menu

- **MEASUREMENT**

1. Center Spot: Press MENU to enable/disable the display cross-hairs. The cross-hairs should be used as a reference only to identify the spot that is being measured for temperature. Use the Laser pointer for more accurate targeting.

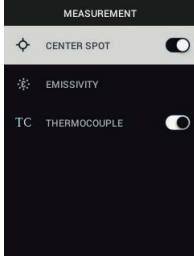

2. Emissivity: Press MENU to open the Emissivity adjustment utility. Use the arrows to scroll through the presets (0.95, 0.80, and 0.60) and use the MENU button to select a preset. Choose the Custom Value utility (last selection on the list) to select a specific emissivity value. At the Custom Value setting, press MENU and then use the arrows to select the emissivity value; press MENU to confirm.

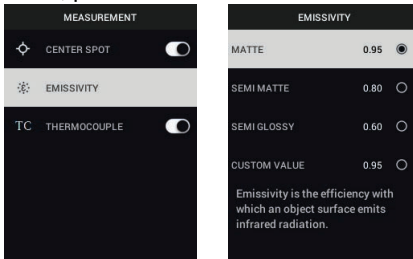

3. Thermocouple: Press MENU to toggle the Thermocouple mode ON/OFF (TG267 only).



## • DEVICE SETTINGS

1. Bluetooth® (TG267 and TG297 only): Press MENU to switch Bluetooth® ON or OFF. See Section 7, *Bluetooth® Communication and FLIR Tools™*, for details.

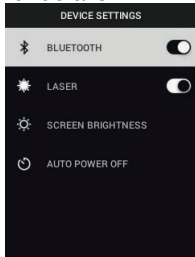

2. Laser: Press MENU to enable/disable the Laser pointer. When enabled, you can use the Laser pointer button to switch ON the Laser pointer. Use the Laser pointer for accurate targeting of measurement spots.

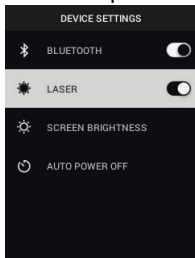

3. Screen brightness: Use the arrows to select the desired display intensity (LOW, MEDIUM, or HIGH).

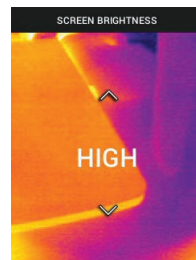
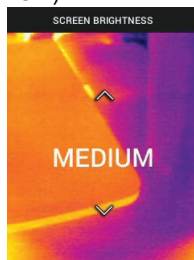
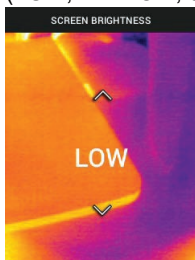

4. Auto Power OFF (APO): Use the arrows to scroll and MENU to select the desired APO time (5/15/30 minutes). Set to 'Never' to disable APO.

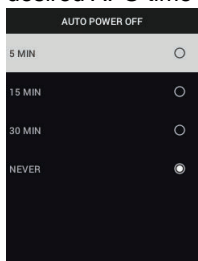

### • GENERAL SETTINGS

1. Temperature Unit: Use the arrows and the MENU button to select °C or °F.

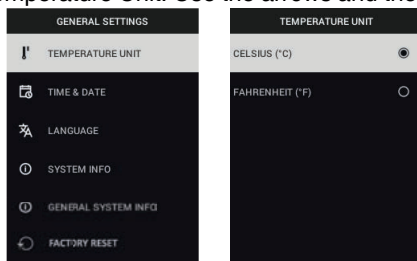

2. Time & Date: Use the arrows to scroll and the MENU button to set the Time, Date, Time Format, and Date Format.

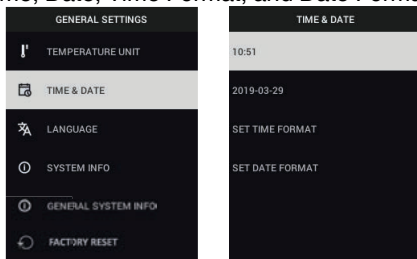

3. Language: Use the arrows to scroll and the MENU button to select a language.

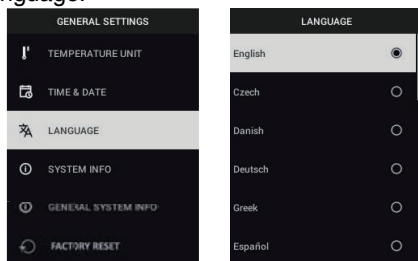

4. System Info: Scroll to desired topic: **Model Number**, **Serial Number**, **Software Level**, **Revision**, **Battery** status (%), and remaining **Internal Storage Capacity**.

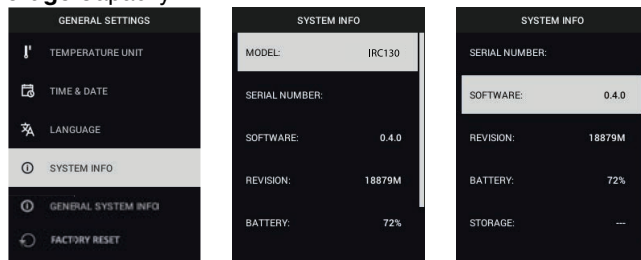

- **GENERAL SYSTEM INFO:** Press MENU to view compliance information.



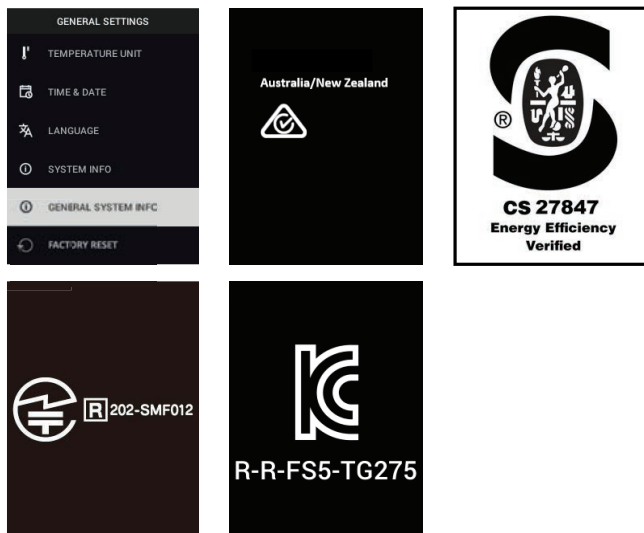

- **FACTORY RESET**: Follow the prompts to reset the User Settings back to Factory Default status.

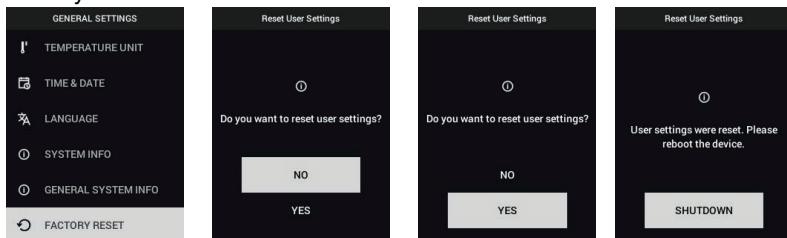

# 7 Bluetooth® Communication and FLIR Tools™

---

## 7.1 Bluetooth® Communication Overview

When paired with a mobile device running the FLIR Tools™ App (using the METERLiNK® protocol), the TG267 and TG297 continually transmit readings for live display on the mobile device. You can also send images, stored on the camera, to your mobile device.

## 7.2 Download the FLIR Tools™ Mobile App

Download the mobile App from the Google Play™ store, the Apple App store, or from this link: <https://www.flir.com/products/flir-tools-app/>.

## 7.3 Setting up the FLIR Tools™ Mobile App

1. Switch the camera's Bluetooth® function ON (*Settings/Device Settings*). See Figure 7.1, below, for illustrations supporting this section.
2. Turn on the mobile device and start the FLIR Tools™ Mobile App.
3. Select INSTRUMENTS from the drop-down menu in the App and search for the camera model number (the camera must be ON).
4. Tap in the App to pair with the camera.

## 7.4 Transmit Images via Bluetooth®

1. Open the camera's Image Gallery from the main menu and scroll to an image using the arrow keys. See Figures 7.2 and 7.3, below, for illustrations supporting this section.
2. Press MENU to open a selected image.
3. Press MENU again to call up the SEND/CANCEL/DELETE/DELETE ALL FILES menu.
4. Select the SEND command to transmit the selected image to the paired mobile device.

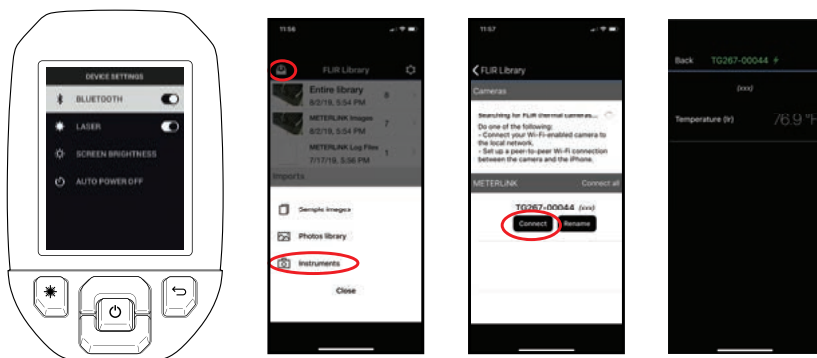

Figure 7.1 Pairing the camera with a Mobile Device

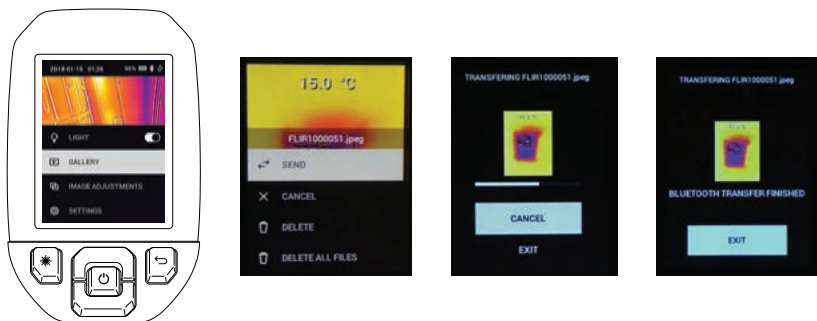
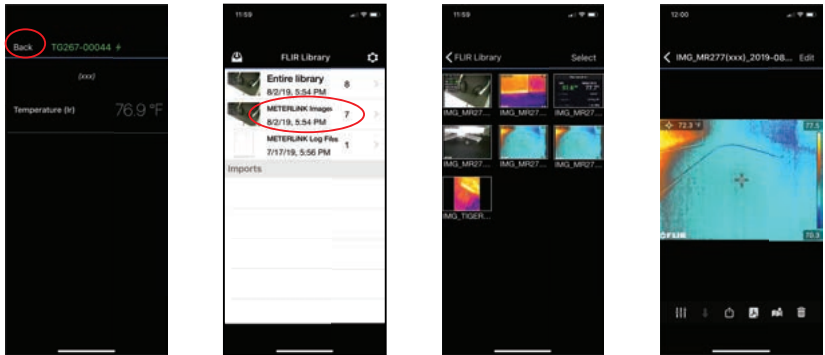

Figure 7.2 Sending Images to a Mobile Device



**Figure 7.3** Viewing Transferred Images on a Mobile Device

## 7.5 FCC Compliance

This device complies with part 15 of the FCC Rules. Operation is subject to the following two conditions:

1. This device may not cause harmful interference.
2. This device must accept any interference received, including interference that may cause undesired operation.

This equipment has been tested and found to comply with the limits for a Class B digital device, pursuant to part 15 of the FCC Rules. These limits are designed to provide reasonable protection against harmful interference in a residential installation. This equipment generates, uses, and can radiate radio frequency energy and, if not installed and used in accordance with the instructions, may cause harmful interference to radio communications. However, there is no guarantee that interference will not occur in a particular installation. If this equipment does cause harmful interference to radio or television reception, which can be determined by turning the equipment off and on, the user is encouraged to try to correct the interference by one or more of the following measures:

1. Reorient or relocate the receiving antenna.
2. Increase the separation between the equipment and receiver.
3. Connect the equipment into an outlet on a circuit different from that to which the receiver is connected.

4. Consult the dealer or an experienced radio/TV technician for help.

**WARNING**

Changes or modifications not expressly approved by the party responsible for compliance could void the user's authority to operate the equipment.

**7.6 GITEKI Certified**

This product is GITEKI certified. The GITEKI mark is displayed in the System Information menu, see the Settings Sub-menu section.

# 8 Field Firmware Updates

---

The camera includes a USB-C port in the top compartment. The USB port allows you to update the System firmware by first downloading an update file from the FLIR website and then transferring the file to the camera via USB. Connect to a PC using a USB-C cable. Firmware updates are available from <https://support.flir.com>.

## NOTE

This camera is not 100% compatible with USB-C to USB-C cables. Use only USB-C to USB-A cables. The supplied cable is USB-C to USB-A type.

To update the firmware, you will need:

- Access to the website where the update file is located: <https://support.flir.com>
- The camera to be updated
- The update file. Refer to the steps in the next section:

### 8.1 System Firmware Update

1. Visit <https://support.flir.com> to obtain a firmware update file.
2. Select the 'Downloads' tab and then select 'Instrument Firmware' (Test and Measurement) from the drop-down menu.
3. Select your camera model from the second drop-down menu.
4. Select and download the firmware update file to the PC.
5. With the camera **ON** connect it to the PC via a USB-C cable (the USB-C port is located in the top compartment).
6. Copy the firmware update file to the camera's root directory.
7. Disconnect the USB cable from the PC and from the camera.
8. Follow the camera's display prompts to complete the update.

# 9 Maintenance

---

## 9.1 Cleaning

Wipe the housing with a damp cloth as needed. Do not use abrasives or solvents. Clean the lenses with a high-quality lens cleaner.

## 9.2 Battery Considerations and Service

The rechargeable lithium battery is not user-serviceable. Please contact FLIR support for service instructions: <https://support.flir.com>.

For best results, charge the battery immediately after seeing a low battery indication using the supplied USB-C cable (with an AC wall charger, not supplied). If the battery is allowed to fully drain, allow 2~3 hours before the charging display appears after connecting to an AC charger. a full charge (100%) requires 6 hours, a charge to 90% power requires 4 hours. Charging through a PC USB port is not recommended.

If the camera is not going to be used for an extended period (> 3 months), it should be charged to 70% then stored at room temperature and recharged every 6 months. Failure to do so may result in a battery that cannot be recharged and that therefore will require service.

## 9.3 Reset the Camera

If the camera display freezes or if the camera in any way stops operating normally, press and hold the up and down buttons for at least 10 seconds. Release the buttons when the camera switches OFF. After the device switches OFF, switch it back ON again to resume use. No data will be lost by resetting the camera. If problems persist, contact FLIR for support.

# 10 Specifications

## 10.1 Imaging and Optical Specifications

IR resolution	TG267 and TG297: 160 x 120 pixels TG165-X: 80 x 60 pixels
Digital image enhancement	Included
Thermal Sensitivity /NETD	< 70 mK
Field of View (FOV)	TG267 and TG297: 57° (H) x 44° (D) TG165-X: 51° (H) x 66° (D)
Minimum focus distance	0.89 ft. (0.3 m)
Distance-to-Spot ratio	30:1 for TG297 24:1 for TG267 and TG165-X
Dual range operation (TG297)	Range 1: < 752°F (400°C) Range 2: > 752°F (400°C) For Range 2, the high temperature lever must be engaged
Focus	Fixed
Image frequency	8.7 Hz

## 10.2 Detector Specifications

Focal plane array /Spectral response range	Uncooled microbolometer /7.5 ~ 14 $\mu\text{m}$
Detector pitch	12 $\mu\text{m}$

## 10.3 Image Presentation Specifications

Display resolution	320 x 240 pixels
Screen size	2.4 in. (portrait)
Viewing angle	80°
Color depth	24 bit
Aspect ratio	4:3
Display type	TFT technology



Image adjustment	Automatic
Image modes	<ul style="list-style-type: none"> <li>• Thermal MSX® (Multi-Spectral Dynamic Imaging)</li> <li>• Visible Spectrum</li> </ul>

#### 10.4 Measurement Specifications

Object temperature range	TG267: -25 ~ +380°C (-13 ~ +716°F) TG297: -25 ~ +1030°C (-13 ~ +1886°F) TG165-X: -25 ~ +300°C (-13 ~ +572°F)
Accuracy at ambient temperature: 59 ~95°F (15 ~ 35°C)	-13°F ~ 32°F (-25°C to 0°C): ± 7.0°F (± 3.0°C)
	32°F ~ 122°F (0°C ~ 50°C): ± 5.0°F (±2.5°C)
	122°F ~ 212°F (50°C ~ 100°C): ± 3.0°F (± 1.5°C)
	212°F ~ 932°F (100°C ~ 500°C): ± 2.5%
	932°F ~ 1022°F (500°C ~ 550°C): ± 3.0%
1022°F ~ 1886°F (550°C ~ 1030°C): ± 3.0%	
IR Temperature resolution	0.2°F (0.1°C)
Reading repeatability	± 1 % of reading
Response time	150 ms
IR thermometer measurement	Continuous scanning
Minimum measurement distance	0.85 ft. (0.26 m)

#### 10.5 Measurement Analysis Specifications

Spot meter	Center spot (cross-hairs); Programmable ON/OFF
Color display palettes	Iron, Rainbow, White-hot, Black-hot, Arctic, and Lava

#### 10.6 Type-K specifications (TG267 only)

Type-K Temperature range of camera	-22°F ~ 734°F (-30.0°C ~ +390.0°C) <sup>1</sup>
Over- and under- range indication	<b>OL</b> or <b>—OL</b> display (dashes display if thermocouple is not connected)

Type-K Temperature Resolution	0.1°F (0.1°C)
Type-K Temperature Accuracy	± (1% of reading + 5.4°F [3°C])
Maximum voltage at Type-K input	60V DC or 24V AC rms

- Note that this is the temperature range of the camera NOT the range for the supplied thermocouple. Please do not exceed the specified range printed on the thermocouple label. To measure higher or lower than the range of the supplied thermocouple, please use a Type-K thermocouple rated for the desired range. Contact FLIR for additional information

### 10.7 Configuration Specifications

Set-up commands	Local adaptation of units, language, date and time formats
Emissivity adjustment	3 presets plus a custom adjustment utility (0.1 ~ 0.99)
Languages	Czech, Danish, Dutch, English, Finnish, French, German, Greek, Hungarian, Italian, Japanese, Korean, Norwegian, Polish, Portuguese, Russian, simplified Chinese, Spanish, Swedish, traditional Chinese, Turkish
Firmware updates	User manageable (instructions included in this user manual)

### 10.8 Image Storage Specifications

Storage media	eMMC 4G
Image storage capacity	50k images
Image file format	JPEG with spot temperature meta-data tag

### 10.9 Digital Camera Specifications

Resolution	2M pixels
Focus	Fixed
Field of View (FOV)	71° x 56° (adapts to IR lens)

### 10.10 Flashlight Specifications

Flashlight type	Bright LED
LED CCT	6500° K
LED CRI	70
Beam angle	± 20°

Rated power	0.5 W
Light output	100 Lumens

### 10.11 Laser Pointer Specifications

Laser type	DOE (Diffractive optical elements)
Laser function	Indicates the size of the measurement area (circular target)
Laser class	Class I

### 10.12 Data Communication and Interface Specifications

Interfaces	USB 2.0 and Bluetooth® (TG267 and TG297 only)
USB	USB-C for data transfer and battery charging Not 100% compatible with USB-C to USB-C cables. Use only a USB-C to USB-A cable.
USB standard	USB 2.0 High Speed
Bluetooth®	BLE (Bluetooth® Low Energy) (TG267 and TG297 only)

### 10.13 Rechargeable Battery Specifications

Battery type	Rechargeable Lithium ion
Battery voltage	3.6 V
Battery operating time	5 hours scanning (medium brightness setting) 4.5 hours with Laser ON (medium brightness setting)
Battery charge life	30 days minimum
Charging system	Battery is charged inside the camera
Charging time	4 hours to 90% and 6 hours to 100%
Power management	APO adjustable 5/15/30 minutes. Can be disabled.

### 10.14 Environmental Specifications

Altitude	6562 ft. (2000 m)
Pollution degree	2
Operating temperature	14 ~ 113°F (-10 ~ 45°C)
Storage temperature	-22 ~ 131°F (-30 ~ 55°C)
Humidity (operating and storage)	0 ~ 90% Relative Humidity (RH) 32 ~ 98.6°F (0 ~ 37°C) 0 ~ 65% RH 98.6 ~ 113°F (37 ~ 45°C) 0 ~ 45% RH 113 ~ 131°F (45 ~ 55°C)
EMC	EN 61000-6-3 EN 61000-6-2 FCC 47 CFR Part 15 Class B
Magnetic fields	EN 61000-4-8 Class 3
Radio spectrum	ETSI EN 300 328 FCC Part 15.249 RSS-247 Issue 2 EN 301 489-1:2011 EN 301 489-17:2009
Encapsulation	IP 54 (IEC 60529)
Shock	25 g (IEC 60068-2-27)
Vibration	2 g (IEC 60068-2-6)
Drop	Designed for 6.56 ft. (2 m)
Safety	CE/CB/EN61010/UL
Environmental safety	REACH Regulation EC 1907/2006 RoHS 2 Directive 2011/65/EC WEEE Directive 2012/19/EC JIS C 6802:2011 laser directive IEC 60825-1 class I laser directive FDA laser directive
Humidity requirements	IEC 60068-2-30 for operation and storage

**10.15 Physical Specifications**

Weight	13.9 oz. (0.39 kg)
Size (L x W x H)	8.3 x 2.5 x 3.2 in. (210 x 64 x 81 mm)
Accessory mount	UNC ¼"-20

**10.16 Included Equipment**

Standard equipment	Camera, USB-C cable, printed Quick Start Guide, Lanyard, Carry Pouch
--------------------	--

# 11 2–10 Extended Warranty

---

To activate the extended 2–10 warranty, please register your product within 60 days of purchase. Otherwise, the standard one-year warranty will be in affect from date of purchase. The 2–10 warranty covers parts and labor for the camera for 2 years and coverage of the detector for 10 years. Register your product at <https://support.flir.com/prodreg>.

# 12 Customer Support

---

Repair, Calibration, and Technical Support: <https://support.flir.com>.

## **12.1 Corporate Headquarters**

FLIR Systems, Inc.

27700 SW Parkway Avenue

Wilsonville, OR 97070, USA









---

**Website**

<http://www.flir.com>

**Customer support**

<http://support.flir.com>

**Copyright**

© 2020, FLIR Systems, Inc. All rights reserved worldwide.

**Disclaimer**

Specifications subject to change without further notice. Models and accessories subject to regional market considerations. License procedures may apply. Products described herein may be subject to US Export Regulations. Please refer to [exportquestions@flir.com](mailto:exportquestions@flir.com) with any questions.

Publ. No.: NAS100014  
Release: AJ  
Commit: 68076  
Head: 68076  
Language: en-US  
Modified: 2020-06-29  
Formatted: 2020-06-29

**Distributed by:**  
Reduction Revolution Pty Ltd  
[www.reductionrevolution.com.au](http://www.reductionrevolution.com.au)