



User's manual

FLIR MR77

Pinless moisture psychrometer with infrared thermometer and Bluetooth METERLINK®

Distributed by:

Reduction Revolution Pty Ltd

www.reductionrevolution.com.au/FLIR





User's manual

FLIR MR77



Table of contents

1	Disclaimers	1
	1.1 Copyright.....	1
	1.2 Quality assurance	1
	1.3 Documentation updates.....	1
	1.4 Disposal of electronic waste.....	1
2	Safety information	2
	2.1 FCC Compliance	2
	2.2 Industry Canada compliance.....	3
3	Introduction	5
	3.1 Key features.....	5
4	Description	6
	4.1 Meter description	6
	4.2 Function buttons	8
	4.3 Display description	9
	4.4 Status icons and indicators.....	9
5	Operation	12
	5.1 Powering the meter	12
	5.2 Moisture measurements.....	12
	5.3 Hygrometric measurements.....	14
	5.4 IR temperature measurements.....	15
	5.5 Condensation measurements.....	16
	5.6 Vapor pressure measurements	17
	5.7 Selecting measurement units	18
	5.8 Storing and recalling measurements.....	18
	5.9 Alarm settings.....	19
	5.10 Locked mode	20
	5.11 Streaming measurement data using Bluetooth.....	21
6	Maintenance	22
	6.1 Cleaning and storage.....	22
	6.2 Battery replacement	22
7	Material groups	23
8	Technical specifications	41
	8.1 General specifications	41
	8.2 Humidity meter specifications.....	42

Table of contents

8.3	Moisture specifications	42
8.4	Thermal measurement range specifications	43
8.5	Vapor pressure specifications	43
8.6	Dew Point Temperature specifications	43
8.7	Mixing Ratio specifications	43
9	Technical support	44
10	Warranties	45
10.1	FLIR Global Limited Lifetime Warranty	45
10.2	FLIR Test and Measurement Limited 2 Year Warranty	46

1 Disclaimers

1.1 Copyright

© 2013, FLIR Systems, Inc. All rights reserved worldwide. No parts of the software including source code may be reproduced, transmitted, transcribed or translated into any language or computer language in any form or by any means, electronic, magnetic, optical, manual or otherwise, without the prior written permission of FLIR Systems.

The documentation must not, in whole or part, be copied, photocopied, reproduced, translated or transmitted to any electronic medium or machine readable form without prior consent, in writing, from FLIR Systems.

Names and marks appearing on the products herein are either registered trademarks or trademarks of FLIR Systems and/or its subsidiaries. All other trademarks, trade names or company names referenced herein are used for identification only and are the property of their respective owners.

1.2 Quality assurance

The Quality Management System under which these products are developed and manufactured has been certified in accordance with the ISO 9001 standard.

FLIR Systems is committed to a policy of continuous development; therefore we reserve the right to make changes and improvements on any of the products without prior notice.

1.3 Documentation updates

Our manuals are updated several times per year, and we also issue product-critical notifications of changes on a regular basis.

To access the latest manuals and notifications, go to the Download tab at:

<http://support.flir.com>

It only takes a few minutes to register online. In the download area you will also find the latest releases of manuals for our other products, as well as manuals for our historical and obsolete products.

1.4 Disposal of electronic waste



As with most electronic products, this equipment must be disposed of in an environmentally friendly way, and in accordance with existing regulations for electronic waste.

Please contact your FLIR Systems representative for more details.

2 Safety information

Note

Before operating the device, you must read, understand, and follow all instructions, dangers, warnings, cautions, and notes.

Note

FLIR Systems reserves the right to discontinue models, parts or accessories, and other items, or to change specifications at any time without prior notice.



WARNING

Do not look directly into the laser beam. The laser beam can cause eye irritation.



WARNING

Do not use the laser pointer near explosive gases or in other possible explosive areas. Injury to persons can occur.



This symbol, adjacent to another symbol or terminal, indicates that the user must refer to the manual for further information.



This symbol, adjacent to a terminal, indicates that, under normal use, hazardous voltages may be present.



Double insulation.

2.1 FCC Compliance

This device complies with part 15 of the FCC Rules. Operation is subject to the following two conditions:

1. This device may not cause harmful interference.
2. This device must accept any interference received, including interference that may cause undesired operation.

This equipment has been tested and found to comply with the limits for a Class B digital device, pursuant to part 15 of the FCC Rules. These limits are designed to

2 Safety information

provide reasonable protection against harmful interference in a residential installation. This equipment generates, uses, and can radiate radio frequency energy and, if not installed and used in accordance with the instructions, may cause harmful interference to radio communications. However, there is no guarantee that interference will not occur in a particular installation. If this equipment does cause harmful interference to radio or television reception, which can be determined by turning the equipment off and on, the user is encouraged to try to correct the interference by one or more of the following measures:

- Reorient or relocate the receiving antenna.
- Increase the separation between the equipment and receiver.
- Connect the equipment into an outlet on a circuit different from that to which the receiver is connected.
- Consult the dealer or an experienced radio/TV technician for help.



CAUTION

Exposure to Radio Frequency Radiation.

To comply with FCC/IC RF exposure compliance requirements, a separation distance of at least 20 cm must be maintained between the antenna of this device and all persons. This device must not be co-located or operating in conjunction with any other antenna or transmitter.



WARNING

Changes or modifications not expressly approved by the party responsible for compliance could void the user's authority to operate the equipment.

2.2 Industry Canada compliance

This device complies with Industry Canada licence-exempt RSS standard(s). Operation is subject to the following two conditions: (1) this device may not cause interference, and (2) this device must accept any interference, including interference that may cause undesired operation of the device.

2 Safety information



CAUTION

Exposure to Radio Frequency Radiation.

To comply with RSS 102 RF exposure compliance requirements, for mobile configurations, a separation distance of at least 20 cm must be maintained between the antenna of this device and all persons. This device must not be co-located or operating in conjunction with any other antenna or transmitter.

3 Introduction

Congratulations on your purchase of the FLIR MR77 with METERLiNK® Bluetooth capabilities for use with FLIR infrared (IR) cameras.

This pinless moisture meter incorporates a patented built-in IR thermometer and 20-point memory. You can monitor moisture in wood and other building materials with no surface damage with the pinless moisture sensor (pin-type moisture probe included), and measure humidity and air temperature with the built-in probe, plus non-contact IR temperature using its patented IR design. Advanced functions provide moisture content, dew point, and vapor pressure calculations.

This meter is shipped fully tested and calibrated and, with proper use, will provide years of reliable service.

3.1 Key features

- Quickly indicates the moisture content of materials with pinless technology without damaging the surface.
- Optional remote pin-type probe (MR77-P) allows for moisture readings at different penetration levels (0.9 m (3') cable length).
- Easy to read, large dual display with backlight feature.
- Simultaneously displays the percentage moisture content of wood or material being tested and the air temperature, IR temperature, or humidity.
- Uses a patented IR design to measure non-contact surface temperature, with an 8:1 distance-to-spot ratio and 0.95 fixed emissivity.
- Built-in humidity/temperature probe measures relative humidity and air temperature plus the mixing ratio and the dew point.
- Measures ambient and surface vapor pressure.
- Automatically calculates the differential temperature.
- Minimum/maximum and data hold modes.
- 20-point internal memory.
- Auto power off and low battery indication.

4 Description

4.1 Meter description

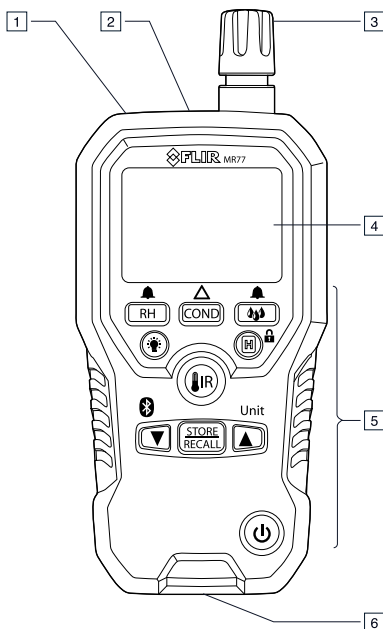

Figure 4.1 Front view

1. IR sensor.
2. Laser pointer diode.
3. Humidity sensor and thermometer.

Note

Protect the sensor with the protective cap when not in use.

4 Description

4. LCD display.
5. Function buttons, see section 4.2 *Function buttons*, page 8.
6. External pin probe connection jack (RJ45).

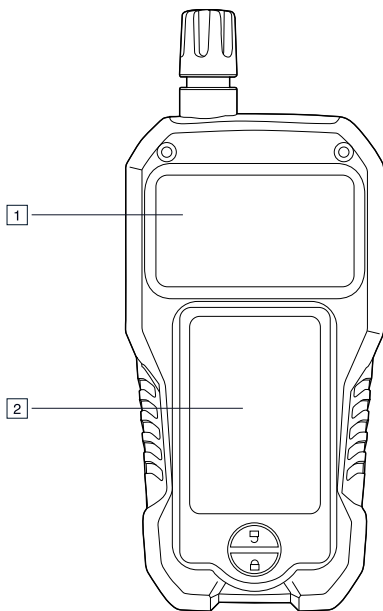







Figure 4.2 Rear view





1. Internal moisture sensor.
2. Battery compartment.

4 Description

4.2 Function buttons

	<ul style="list-style-type: none">• Press the button to enter Hygrometer mode, see section 5.3 <i>Hygrometric measurements</i>, page 14.• Press the button repeatedly to cycle through the display of relative humidity, dew point temperature, and mix ratio.• Press and hold the button for 2 seconds to enter Humidity alarm set mode, see section 5.9 <i>Alarm settings</i>, page 19.
	<ul style="list-style-type: none">• Press the button to enter Condensation mode, see section 5.5 <i>Condensation measurements</i>, page 16.• Press the button repeatedly to toggle between Condensation mode and Vapor pressure mode, see section 5.6 <i>Vapor pressure measurements</i>, page 17.• When in Moisture mode, press and hold the button for 2 seconds to toggle between the relative and absolute readings, see section 5.2 <i>Moisture measurements</i>, page 12.
	<ul style="list-style-type: none">• Press the button to enter Moisture mode, see section 5.2 <i>Moisture measurements</i>, page 12.• Press the button repeatedly to toggle between the internal sensor and external pin probe measurements.• Press and hold the button for 2 seconds to enter Moisture alarm set mode, see section 5.9 <i>Alarm settings</i>, page 19.
	Press the button to enable/disable the display backlight.
	<ul style="list-style-type: none">• Press the button to toggle between Normal and Hold mode. In Hold mode, the display freezes the last reading and continues to display this value.• Press and hold the button for 5 seconds to toggle between Normal and Locked mode, see section 5.10 <i>Locked mode</i>, page 20.
	Press and hold the button to enable IR temperature measurements, see section 5.4 <i>IR temperature measurements</i> , page 15.

4 Description

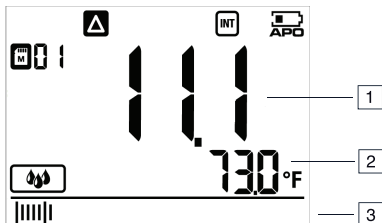

	<ul style="list-style-type: none">• Press and hold the button for 2 seconds to change the unit setting. For more information, see section 5.7 <i>Selecting measurement units</i>, page 18.• When in View data mode, press the button to step through the datalogger memory locations.
	When in View data mode, press the button to step through the datalogger memory locations.
	Press the button to capture and store the current readings. For more information, see section 5.8 <i>Storing and recalling measurements</i> , page 18.
	Press the button to switch the meter on/off.

4.3 Display description

















1. Main display.
2. Secondary display.
3. Bar graph (matches the reading on the main display).

4.4 Status icons and indicators

	Indicates that METERLiNK® (Bluetooth) communication is active, see section 5.11 <i>Streaming measurement data using Bluetooth</i> , page 21.
	Indicates that the IR sensor and the laser pointer diode are active.

4 Description



	Indicates that the meter is displaying relative moisture measurements (solid indicator) or absolute moisture measurements (flashing indicator).
	Indicates that the meter is in Hold mode.
	Indicates that the reading is lower than the Low alarm threshold.
	Indicates that the reading is higher than the High alarm threshold.
	Indicates that the meter is in Locked mode.
	Indicates that the internal moisture sensor is active.
	Indicates that the external pin probe is active.
	Indicates the battery voltage status.
APO	Indicates that the auto power off function is enabled.
	Indicates the active datalogger memory location (1–20).
	Indicates that the meter is in Hygrometer mode.
	Indicates that the meter is displaying dew point temperature readings on the main display.
	Indicates that the meter is in Condensation mode.
	Indicates that the meter is in Moisture mode.
	Indicates the number that represents the material group under test, see section 7 <i>Material groups</i> , page 23.
mBar kPa	Indicates that the meter is displaying vapor pressure in millibar (mBar) or in kilopascal (kPa) units.
GPP g/kg	Indicates that the meter is displaying the mixing ratio in grains per pound (GPP) or in grams per kilogram (g/kg) units.

4 Description

%	Indicates that the meter is displaying relative humidity in percent (%) units.
°C	Indicates that the meter is displaying temperature in degrees Celsius (°C) units.
°F	Indicates that the meter is displaying temperature in degrees Fahrenheit (°F) units.
	High/low calibration point.

5 Operation



5.1 Powering the meter

1. Remove the protective cap from the humidity sensor/thermometer assembly.
2. Press the  button to switch on the meter.
3. If the battery indicator  shows that the battery voltage is low or if the meter does not power on, replace the battery. See section 6.2 *Battery replacement*, page 22.
4. Press the  button to switch off the meter.

5.1.1 Auto power off

The meter enters sleep mode after 30 minutes of inactivity. The meter beeps three times 20 seconds before powering off. Press any function button to prevent the meter from powering off. The auto power off time-out is then reset.

5.1.1.1 Disable auto power off

1. To disable the auto power off function, start with the meter switched off.
2. Simultaneously press and hold the  and  buttons until the **APO** indicator disappears, indicating that the function is disabled.

5.2 Moisture measurements

With the meter in Moisture mode, moisture measurements can be performed using either the internal moisture sensor or by connecting the external pin probe.



The internal moisture sensor can detect moisture to a depth of 19 mm (0.75"). The internal moisture reading can be relative or absolute.

The three-digit main display shows the moisture reading, and the four-digit secondary display shows the ambient air temperature. The bar graph matches the reading on the main display.

While in Moisture mode, IR measurements may also be performed, see section 5.4 *IR temperature measurements*, page 15.

5.2.1 Internal moisture sensor

1. Press the  button to enter the Moisture mode.

The  and  indicators are displayed. The  indicator is also displayed, indicating that the meter is displaying relative measurements. The ambient temperature is displayed on the secondary display.

2. Place the internal moisture sensor (located on the rear side of the meter) on the surface of the material to be tested.

The relative moisture reading is displayed on the main display. No units of measurement are displayed.

3. Absolute or Zero Mode measurements. This mode allows measurements to be displayed as a difference between the actual reading and a stored reference reading. Follow the steps below.

1. For best results, keep hands and other surfaces and objects away from the internal moisture sensor area when turning on the unit.



2. Place the internal moisture sensor on the surface that will be the "reference" surface. Press and hold the  button for 2 seconds until the indicator flashes. This will zero the meter at the reference value.



3. Place the internal moisture sensor on the surface of the material to be tested. The measurement will be read as the offset value of your stored reference.

4. Press and hold the  button for 2 seconds to return to normal internal moisture measurement mode.

5.2.2 External pin probe

1. Connect the external pin probe to the EXT connection jack (located at the bottom of the meter).

2. Press the  button to enter the Moisture mode. The  indicator is displayed.

3. Press the  button once more to activate external pin probe measurements. The  indicator is displayed.



5 Operation

4. The  indicator shows the currently selected material group number. Refer to section 7 *Material groups*, page 23.

To change the material group number, do the following:

1. Press and hold the  and  buttons for 2 seconds to enter the Material group selection mode.

The  indicator flashes.

2. Use the  and  buttons to step through the nine material group numbers.
 3. Press the  button to set the group and exit the Material group selection mode.
5. Press the probe pins into the material.



The moisture reading is displayed on the main display, in percent (%).

5.3 Hygrometric measurements

In Hygrometer mode, the meter measures and displays the relative humidity, dew point temperature, mixing ratio, and ambient air temperature.

The three-digit main display shows the relative humidity, dew point temperature, or mixing ratio, and the four-digit secondary display shows the ambient air temperature. The bar graph matches the reading on the main display.

While in Hygrometer mode, IR measurements may also be performed, see section 5.4 *IR temperature measurements*, page 15.

1. Press the  button to enter Hygrometer mode. The  indicator is displayed.
2. The relative humidity is displayed on the main display. The ambient air temperature is displayed on the secondary display.

5 Operation

- Press the **RH** button repeatedly to cycle through the display of relative humidity, dew point temperature, and mixing ratio.
 - Relative humidity: The **RH** indicator is displayed and the reading is displayed in percent (%).
 - Dew point temperature: The **DEW** indicator is displayed and the reading is displayed in °C or °F, depending on the unit setting.
 - Mixing ratio: The reading is displayed in grains per pound (GPP) or grams per kilogram (g/kg), depending on the unit setting.

5.4 IR temperature measurements

IR temperature measurements can be performed in all operating modes.

The meter is equipped with a laser pointer diode, which is used as a targeting pointer for the IR temperature measurements. The target of the measurement should be larger than the size of the laser beam spot. As the distance from an object increases, the spot size of the area measured by the meter becomes larger. The meter's field of view ratio is 8:1, meaning that if the meter is 8 inches (20 cm) from the target, the diameter (spot) of the object under test must be at least 1 inch (2.54 cm). Refer to Figure 5.1.

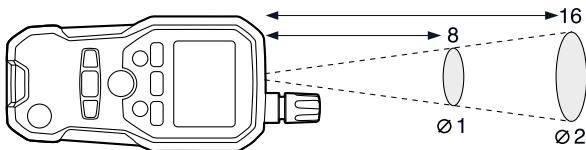

Figure 5.1 IR spot-to-distance ratio

IR measurement notes:

- The object under test should be larger than the size of the laser beam spot.
- If the surface of the object under test is covered with frost, oil, grime, etc., clean the surface before measuring.
- If the surface of the object is highly reflective, apply masking tape or flat black paint to the surface before measuring.
- The meter may not make accurate measurements through transparent surfaces such as glass.

5 Operation

- Steam, dust, smoke, etc., may obscure measurements.
- To find a hot spot, aim the meter outside the area of interest, then scan across (in an up and down motion) until the hot spot is located.







WARNING

Do not look directly into the laser beam. The laser beam can cause eye irritation.







WARNING

Do not use the laser pointer near explosive gases or in other possible explosive areas. Injury to persons can occur.



1. Press and hold the  button to enable the IR sensor and the laser pointer diode. The  indicator is displayed.
2. Aim the laser pointer at the surface to be measured. The IR temperature reading is displayed on the four-digit secondary display.
3. Release the  button to disable the IR sensor and the laser pointer diode. The last IR temperature reading remains on the display for 8 seconds; then the meter returns to a display of the ambient air temperature, and the  indicator disappears.

5.5 Condensation measurements

In Condensation mode, the meter determines whether a surface is at risk of condensation, based on measurements of the dew point temperature (relative humidity and ambient air temperature) and the IR temperature of the surface.







1. Press the  button to enter the Condensation mode. The  indicator is displayed.
2. Aim the meter at the surface. Press and hold the  button. The  indicator is displayed

5 Operation

- The dew point temperature is displayed on the main display. The IR temperature of the surface is displayed on the secondary display. The bar graph indicates the level of risk for condensation:
 - If the IR temperature is more than 14°C (25°F) above the dew point temperature, the bar graph is empty.
 - If the IR temperature is 3–14°C (5–25°F) above the dew point temperature, the bar graph indicates a percentage of full scale.
 - If the IR temperature is less than 3°C (5°F) above the dew point temperature, the bar graph is full.
- Release the  button to disable the IR sensor and the laser pointer diode. The last IR temperature reading remains on the display for 8 seconds; then the meter returns to a display of the ambient air temperature and the  indicator disappears.

5.6 Vapor pressure measurements

Vapor pressure measurement is a special variant of condensation measurement. The meter calculates the vapor pressure based on measurements of the relative humidity and the IR temperature of the surface.

- Press the  button to enter Condensation mode. The  indicator is displayed. The unit of measurement on the main display is °C or °F, depending on the unit setting.
- Press the  button once more to enter Vapor pressure mode. The unit of measure on the main display changes to kPa or mBar, depending on unit setting.
- Aim the meter at the surface. Press and hold the  button.
- The vapor pressure is displayed on the main display. The IR temperature of the surface is displayed on the secondary display.
- Release the  button to disable the IR sensor and the laser pointer diode. The last IR temperature reading remains on the display for 8 seconds; then the meter returns to a display of the ambient air temperature and the  indicator disappears.

5 Operation

5.7 Selecting measurement units

There are two sets of units; US and metric. The unit setting can be changed at any time in any mode, by pressing and holding the  button for 2 seconds.

The unit setting applies to all modes. It is *not* possible to, for example, display moisture in g/kg while showing temperature in °F.

US unit setting:

- Temperature is displayed in degrees Fahrenheit (°F).
- Mixing ratio is displayed in grains per pound (GPP).
- Vapor pressure is displayed in millibars (mBar).

Metric unit setting:

- Temperature is displayed in degrees Celsius (°C).
- Mixing ratio is displayed in grams per kilogram (g/kg).
- Vapor pressure is displayed in kilopascals (kPa).

5.8 Storing and recalling measurements

5.8.1 Datalogger memory locations

The meter has 20 datalogger memory locations for the storage of measurement data. Each memory location stores the current readings for all operating modes, with the current unit settings. Thus, each location contains moisture, humidity, ambient temperature, and IR temperature data.









5.8.2 Storing a measurement

1. Press the  button to capture and store the currently displayed readings.

The data is saved to the memory location shown by the  indicator. The memory location indicator then advances to the next location. When the 20 memory locations are full, the meter overwrites saved readings, starting with memory location 1.

5 Operation



5.8.3 View data

1. Press and hold the  button for 2 seconds to enter View data mode.
The  indicator flashes, and the data stored in that location is displayed.
2. Press the  or  button to step through the memory locations.
3. Press the , , or  button to display the stored data for the different modes.
4. Press and hold the  button for 2 seconds until a single beep sounds to exit View data mode.



5.8.4 Clearing the data from memory

Note

To avoid deleting valuable data when done viewing your data, advance the memory to an empty location before exiting this mode.

1. Press and hold the  button for 2 seconds to enter View data mode.
2. In View data mode, press and hold the  and  buttons simultaneously for 3 seconds to clear all data.



5.9 Alarm settings

High and low alarm thresholds can be set for moisture and humidity measurements. If either of the thresholds is exceeded during the measurement, the meter beeps and the corresponding alarm indicator is displayed: the low alarm indicator  or the high alarm indicator .







The default setting for the moisture and humidity alarms is off.

5 Operation







1. To enter the alarm set mode, do one of the following:

- To enter the Moisture alarm set mode, press and hold the  button for 2 seconds.
- To enter the Humidity alarm set mode, press and hold the  button for 2 seconds.



The current high threshold or *OFF* (if the alarm is disabled) is flashing on the main display.

2. To switch from *OFF* to the numerical display, momentarily press both the  and  buttons simultaneously.
3. Use the  and  buttons to adjust the high alarm threshold.
4. To disable the high alarm, simultaneously press the  and  buttons.
5. When the desired high alarm threshold (or *OFF*) is displayed, press the  button to save the value.



The current low threshold or *OFF* (if the alarm is disabled) is now flashing on the main display.

6. To switch from *OFF* to the numerical display, simultaneously press the  and  buttons.
7. Use the  and  buttons to adjust the low alarm threshold. The low alarm value cannot exceed the high alarm value.
8. To disable the low alarm, simultaneously press the  and  buttons.
9. When the desired low alarm threshold (or *OFF*) is displayed, press the  button to save the value and exit the alarm set mode.

5.10 Locked mode

In Locked mode, the meter ignores all button presses except   and . The auto power off function, see section 5.1.1 *Auto power off*, page 12, is disabled in Locked mode.

5 Operation

1. To enter Locked mode, press and hold the  button for 5 seconds.
The  indicator is displayed.
2. To exit Locked mode, press and hold the  button for 5 seconds once again.

5.11 Streaming measurement data using Bluetooth

5.11.1 General

Some IR cameras from Flir Systems support Bluetooth communication and to those cameras you can stream measurement data from the meter. The data is then merged into the result table in the IR image.

Streaming measurement data is a convenient way to add important information to an IR image. For example, when identifying a water leakage in a wall, you may want to know the humidity in the wall.

The Bluetooth range is 10m (32ft) maximum.

5.11.2 Procedure

1. Pair the IR camera with the instrument. Refer to the camera manual for information on how to pair Bluetooth devices.
2. Turn on the camera.
3. Turn on the meter.
4. Press and hold the  button on the meter to enable Bluetooth.
5. Take a measurement reading. Results from the meter will now automatically be displayed in the result table in the top left corner of the IR camera screen.

6 Maintenance

6.1 Cleaning and storage

Clean the meter with a damp cloth and mild detergent; do not use abrasives or solvents.

If the meter is not to be used for an extended period, remove the battery and store it separately.

6.2 Battery replacement

1. Switch off the meter before attempting to replace the battery.
2. Turn the half turn screw so that the UNLOCK symbol is facing up and then lift open the battery compartment.
3. Replace the standard 9 V battery.
4. Secure the battery compartment cover.

6.2.1 Disposal of electronic waste



As with most electronic products, this equipment must be disposed of in an environmentally friendly way, and in accordance with existing regulations for electronic waste.

Please contact your FLIR Systems representative for more details.

7 Material groups

The tables below list woods types along with the material group number that should be selected for each type.

Table 7.1 Common names of timbers (BS888 & 589:1973) with selectable FLIR MR77 material group numbers. Note: Material Group No. 9 should be used for building materials (chip board, dry wall, and plywood)

Abura	4
Afara	1
Aformosa	6
Azelia	4
Agba	8
Amboyna	6
Ash, American	2
Ash, European	1
Ash, Japanese	1
Ayan	3
Baguacu, Brazilian	5
Balsa	1
Banga Wanga	1
Basswood	6
Beech, European	3
Berlina	2
Binvang	4
Birch, European	8
Birch, Yellow	1
Bisselon	4

7 Material groups

Table 7.1 Common names of timbers (BS888 & 589:1973) with selectable FLIR MR77 material group numbers. Note: Material Group No. 9 should be used for building materials (chip board, dry wall, and plywood) (continued)

Bitterwood	5
Blackbutt	3
Bosquiea	1
Boxwood, Maracaibo	1
Camphorwood, E African	3
Canarium, African	2
Cedar, Japanese	2
Cedar, West Indian	8
Cedar, Western Red	3
Cherry, European	8
Chestnut	3
Coachwood	6
Cordia, American Light	5
Cypress, E African	1
Cypress, Japanese (18–28%mc)	3
Cypress, Japanese (8–18%mc)	8
Dahoma	1
Danta	3
Douglas Fir	2
Elm, English	4
Elm, Japanese Grey Bark	2
Elm, Rock	4

7 Material groups

Table 7.1 Common names of timbers (BS888 & 589:1973) with selectable FLIR MR77 material group numbers. Note: Material Group No. 9 should be used for building materials (chip board, dry wall, and plywood) (continued)

Elm, White	4
Empress Tree	8
Erimado	5
Fir, Douglas	2
Fir, Grand	1
Fir, Noble	8
Gegu, Nohor	7
Greenheart	3
Guarea, Black	8
Guarea, White	7
Gum, American Red	1
Gum, Saligna	2
Gum, Southern	2
Gum, Spotted	1
Gurjun	1
Hemlock, Western	3
Hiba	8
Hickory	5
Hyedunani	2
Iroko	5
Ironbank	2
Jarrah	3
Jelutong	3

7 Material groups

Table 7.1 Common names of timbers (BS888 & 589:1973) with selectable FLIR MR77 material group numbers. Note: Material Group No. 9 should be used for building materials (chip board, dry wall, and plywood) (continued)

Kapur	1
Karri	1
Kauri, New Zealand	4
Kauri, Queensland	8
Keruing	5
Kuroka	1
Larch, European	3
Larch, Japanese	3
Larch, Western	5
Lime	4
Loliondo	3
Mahogany, African	8
Mahogany, West Indian	2
Makore	2
Mansonia	2
Maple, Pacific	1
Maple, Queensland	2
Maple, Rock	1
Maple, Sugar	1
Matai	4
Meranti, Red (dark/light)	2
Meranti, White	2
Merbau	2

7 Material groups

Table 7.1 Common names of timbers (BS888 & 589:1973) with selectable FLIR MR77 material group numbers. Note: Material Group No. 9 should be used for building materials (chip board, dry wall, and plywood) (continued)

Missanda	3
Muhuhi	8
Muninga	6
Musine	8
Musizi	8
Myrtle, Tasmanian	1
Naingon	3
Oak, American Red	1
Oak, American White	1
Oak, European	1
Oak, Japanese	1
Oak, Tasmanian	3
Oak, Turkey	4
Obeche	6
Odoko	4
Okwen	2
Olive, E African	2
Olivillo	6
Opepe	7
Padang	1
Padauk, African	5
Panga Panga	1
Persimmon	6

7 Material groups

Table 7.1 Common names of timbers (BS888 & 589:1973) with selectable FLIR MR77 material group numbers. Note: Material Group No. 9 should be used for building materials (chip board, dry wall, and plywood) (continued)

Pillarwood	5
Pine, American Long Leaf	3
Pine, American Pitch	3
Pine, Bunya	2
Pine, Caribbean Pitch	3
Pine, Corsican	3
Pine, Hoop	3
Pine, Huon	2
Pine, Japanese Black	2
Pine, Kauri	4
Pine, Lodgepole	1
Pine, Maritime	2
Pine, New Zealand White	2
Pine, Nicaraguan Pitch	3
Pine, Parana	2
Pine, Ponderosa	3
Pine, Radiata	3
Pine, Red	2
Pine, Scots	1
Pine, Sugar	3
Pine, Yellow	1
Poplar, Black	1

7 Material groups

Table 7.1 Common names of timbers (BS888 & 589:1973) with selectable FLIR MR77 material group numbers. Note: Material Group No. 9 should be used for building materials (chip board, dry wall, and plywood) (continued)

Pterygota, African	1
Pyinkado	4
Queensland Kauri	8
Queensland Walnut	3
Ramin	6
Redwood, Baltic (European)	1
Redwood, Californian	2
Rosewood, Indian	1
Rubberwood	7
Santa Maria	7
Sapele	3
Sen	1
Seraya, Red	3
Silky Oak, African	3
Silky Oak, Australian	3
Spruce, Japanese (18–28%mc)	3
Spruce, Japanese (8–18%mc)	8
Spruce, Norway (European)	3
Spruce, Sitka	3
Sterculia, Brown	1
Stringybark, Messmate	3
Stringybark, Yellow	3

7 Material groups

Table 7.1 Common names of timbers (BS888 & 589:1973) with selectable FLIR MR77 material group numbers. Note: Material Group No. 9 should be used for building materials (chip board, dry wall, and plywood) (continued)

Sycamore	5
Tallowwood	1
Teak	5
Totara	4
Turpentine	3
Utile	8
Walnut, African	8
Walnut, American	1
Walnut, European	3
Walnut, New Guinea	2
Walnut, Queensland	3
Wandoo	8
Wawa	6
Whitewood	3
Yew	3

7 Material groups

Table 7.2 Botanical names of timbers with selectable FLIR MR77 material group numbers.

<i>Abies alba</i>	1
<i>Abies grandis</i>	1
<i>Abies procera</i>	8
<i>Acanthopanax ricinifolius</i>	1
<i>Acer macrophyllum</i>	1
<i>Acer pseudoplatanus</i>	5
<i>Acer saccharum</i>	1
<i>Aetoxicon punctatum</i>	6
<i>Aformosia elata</i>	6
<i>Azelia</i> spp	4
<i>Agathis australis</i>	4
<i>Agathis palmerstoni</i>	8
<i>Agathis robusta</i>	8
<i>Amblygonocarpus andogensis</i>	1
<i>Amblygonocarpus obtusungulis</i>	1
<i>Araucaria angustifolia</i>	2
<i>Araucaria bidwilli</i>	2
<i>Araucaria cunninghamii</i>	3
<i>Berlinia grandiflora</i>	2
<i>Berlinia</i> spp	2
<i>Betula alba</i>	8
<i>Betula alleghaniensis</i>	8
<i>Betula pendula</i>	8

7 Material groups

Table 7.2 Botanical names of timbers with selectable FLIR MR77 material group numbers. (continued)

Betula spp	8
Bosquiera phoberos	1
Brachylaena hutchinsii	8
Brachystegia spp	2
Calophyllum brasiliense	7
Canarium schweinfurthii	2
Cardwellia sublimes	3
Carya glabra	5
Cassipourea elliotii	5
Cassipourea melanosana	5
Castanea sutiva	3
Cedrela odorata	8
Ceratopetalum apetala	6
Chamaecyparis spp (18–28%mc)	3
Chamaecyparis spp (8–18%mc)	8
Chlorophora excelsa	5
Cordia alliodora	5
Croton megalocarpus	8
Cryptomelia japonica	2
Cupressus spp	1
Dacryium franklinii	2
Dalbergia latifolia	1
Diospyros virginiana	6

7 Material groups

Table 7.2 Botanical names of timbers with selectable FLIR MR77 material group numbers. (continued)

Dipterocarpus (Keruing)	5
Dipterocarpus zeylanicus	1
Distemonanthus benthamianus	3
Dracontomelium mangiferum	2
Dryobalanops spp	1
Dyera costulata	3
Endiandra palmerstoni	3
Entandrophragma angolense	7
Entandrophragma cylindricum	3
Entandrophragma utile	8
Erythrophleum spp	3
Eucalyptus acmenicides	3
Eucalyptus crebra	2
Eucalyptus diversicolor	1
Eucalyptus globulus	2
Eucalyptus maculate	1
Eucalyptus marginata	3
Eucalyptus microcorys	1
Eucalyptus obliqua	3
Eucalyptus pilularis	3
Eucalyptus saligna	2
Eucalyptus wandoo	8

7 Material groups

Table 7.2 Botanical names of timbers with selectable FLIR MR77 material group numbers. (continued)

<i>Fagus sylvatica</i>	3
<i>Flindersia brayleyana</i>	2
<i>Fraxinus Americana</i>	2
<i>Fraxinus excelsior</i>	1
<i>Fraxinus japonicus</i>	1
<i>Fraxinus mardshurica</i>	1
<i>Gonystylus macrophyllum</i>	6
<i>Gossweilodendron balsamiferum</i>	8
<i>Gossypiospermum proerox</i>	1
<i>Grevillea robusta</i>	3
<i>Guarea cedrata</i>	7
<i>Guarea thomsonii</i>	8
<i>Guibortia ehie</i>	2
<i>Hevea brasiliensis</i>	7
<i>Intsia bijuga</i>	2
<i>Juglans nigra</i>	1
<i>Juglans regia</i>	3
<i>Khaya ivorensis</i>	8
<i>Khaya senegalensis</i>	4
<i>Larix decidua</i>	3
<i>Larix kaempferi</i>	3
<i>Larix leptolepis</i>	3
<i>Larix occidentalis</i>	5

7 Material groups

Table 7.2 Botanical names of timbers with selectable FLIR MR77 material group numbers. (continued)

Liquidamper styraciflua	1
Lovoa klaineana	8
Lovoa trichiloides	8
Maesopsis eminii	8
Mansonia altissima	2
Millettia stuhimannii	1
Mimusops heckelii	2
Mitragyna ciliata	4
Nauclea diderrichii	7
Nesogordonia papaverifera	3
Nothofagus cunninghamii	1
Ochroma lagopus	1
Ochroma pyramidalis	1
Ocotea rodiaei	3
Ocotea usambarensis	3
Octomeles sumatrana	4
Olea hochstetteri	2
Olea welwitschii	3
Palaquium spp	1
Paulownia tomentosa	8
Pericopsis elata	6
Picaenia excelsa	3
Picea abies	3
Picea jezoensis (18–28%mc)	3

7 Material groups

Table 7.2 Botanical names of timbers with selectable FLIR MR77 material group numbers. (continued)

<i>Picea jezoensis</i> (8–18%mc)	8
<i>Picea sitchensis</i>	3
<i>Pinus caribaea</i>	3
<i>Pinus contorta</i>	1
<i>Pinus lampertiana</i>	3
<i>Pinus nigra</i>	3
<i>Pinus palustris</i>	3
<i>Pinus pinaster</i>	2
<i>Pinus ponderosa</i>	3
<i>Pinus radiata</i>	3
<i>Pinus</i> spp	2
<i>Pinus strobus</i>	1
<i>Pinus sylvestris</i>	1
<i>Pinus thunbergii</i>	2
<i>Pipadeniastrum africanum</i>	1
<i>Piptadenia africana</i>	1
<i>Podocarpus dactyloides</i>	2
<i>Podocarpus spicatus</i>	3
<i>Podocarpus totara</i>	4
<i>Populus</i> spp	1
<i>Prunus avium</i>	8
<i>Pseudotsuga menziesii</i>	2
<i>Pterocarpus angolensis</i>	6

7 Material groups

Table 7.2 Botanical names of timbers with selectable FLIR MR77 material group numbers. (continued)

<i>Pterocarpus indicus</i>	6
<i>Pterocarpus soyauxii</i>	5
<i>Pterygota bequaertii</i>	1
<i>Quercus cerris</i>	4
<i>Quercus delegatensis</i>	3
<i>Quercus gigantea</i>	3
<i>Quercus robur</i>	1
<i>Quercus</i> spp	1
<i>Ricinodendron heudelotti</i>	5
<i>Sarcocephalus diderrichii</i>	7
<i>Scottellia coriacea</i>	4
<i>Sequoia sempervirens</i>	2
<i>Shorea smithiana</i>	3
<i>Shorea</i> spp	2
<i>Sterculia rhinopetala</i>	1
<i>Swietenia candollei</i>	1
<i>Swietenia mahogani</i>	2
<i>Syncarpia glomulifera</i>	3
<i>Syncarpia laurifolia</i>	3
<i>Tarrietia utilis</i>	3
<i>Taxus baccata</i>	3
<i>Tectona grandis</i>	5
<i>Terminalia superba</i>	1

7 Material groups

Table 7.2 Botanical names of timbers with selectable FLIR MR77 material group numbers. (continued)

Thuja plicata	3
Thujopsis dolabrat	8
Tieghamella heckelii	2
Tilia americana	6
Tilia vulgaris	4
Triploehiton scleroxylon	6
Tsuga heterophylla	3
Ulmus americana	4
Ulmus procera	4
Ulmus thomasii	4
Xylia dolabriformis	4
Zelkova serrata	2

7 Material groups

Table 7.3 The table below shows the material group numbers and the moisture range (scale) for each group in %WME.

Material Wood Group Nos.									
1	2	3	4	5	6	7	8	9	
%WME (percent wood moisture equivalent)									
7	8.2	9	8	7.1	7	11	10.5	-	
8	10	10.5	9.3	7.5	7.4	11.5	11	-	
9	10.8	10.9	9.7	7.9	8.1	12.1	11.6	8.5	
10	11.7	11.5	10.4	8.6	8.8	12.7	12.2	9.4	
11	12.7	12.6	11.3	9.5	9.7	13.4	13.4	10.5	
12	13.6	13.7	12.1	10.5	10.5	14	14.3	11.5	
13	14.5	14.5	12.7	11.2	11.2	14.5	15.1	12.5	
14	15.3	15.5	13.4	11.8	11.8	15	16	13.5	
15	16.3	16.7	14.1	12.5	12.6	15.6	17	14.4	
16	16.9	17.5	14.8	13	13.2	16	17.7	14.9	
17	17.7	18.8	15.7	14.3	13.9	16.6	18.5	15.3	
18	18.2	19.7	16.3	15	14.5	17	19.1	16.1	
19	19	21	16.9	15.9	15.2	17.6	20	16.7	
20	20	22.6	17.8	16.9	16.1	18.4	21.3	17.2	

7 Material groups

Table 7.3 The table below shows the material group numbers and the moisture range (scale) for each group in %WME. (continued)

21	20.8	23.5	18.5	17.6	16.8	19.1	22.3	18.3
22	21.5	24.5	29.3	18.3	17.4	19.7	23.2	19.1
23	22.9	26.4	20.2	19.8	18.6	21.2	25.3	19.9
24	23.5	27.4	20.8	20.4	19	22	25.8	20.5
25	24.2	27.8	21.2	21	19.4	22.7	26.3	≈23
26	25.3	29	22.4	22.3	20.1	23.9	27.3	-
27	26.5	-	23.3	23.4	20.8	24.7	28.1	-
28	28	-	24.4	24.8	21.7	25.9	-	-
29	29.6	-	25.6	26.3	22.9	27.1	-	-

8 Technical specifications

Accuracy specifications for all measurement ranges are applicable under the following ambient conditions: 18°C to 28°C (64.4°F to 82.4°F); <80% RH.

8.1 General specifications

Display	<ul style="list-style-type: none">• 3-digit 15 mm (0.6") main display• 4-digit 6 mm (0.24") secondary display• 10-segment bar graph• Memory counter
Controls	<ul style="list-style-type: none">• 7 dedicated function buttons: moisture, relative humidity, condensation, hold/lock, up (↑), down (↓), store/recall• 4 auxiliary buttons: IR, Bluetooth, backlight/work light, power
Other indications	<ul style="list-style-type: none">• 24 icon-style locations + 2-digit memory indicator• Piezo beeper (85 dBA)
Sample rate	2 per second
Backlight	White LED
Internal memory	(1) storage location
Power supply	1 × 9 V battery (MN1604 or equivalent)
Battery life	100 hours, using alkaline batteries, with no backlight/work light use
Auto power off (APO)	After 30 minutes (nominal) inactivity, with audible pre-alert; reset when the power button is pressed. Disable function supported
APO quiescent current	50 µA maximum

8 Technical specifications

Operating temperature	0 to 50°C (32 to 122°F)
Storage temperature	-10 to 60°C (14 to 140°F)
Operating humidity	<ul style="list-style-type: none">• 90%, 0 to 30°C (32 to 86°F)• 75%, 30 to 40°C (86 to 104°F)• 45%, 40 to 50°C (104 to 122°F)
Storage humidity	90% maximum
Dimensions (excluding sensor)	139 mm × 72 mm × 42 mm (5.4" × 2.8" × 1.7")
Weight	0.29 kg (0.65 lb.), including batteries
Bluetooth range	10 m (32 ft) maximum
Agency approvals	FCC Class B

8.2 Humidity meter specifications

Function	Range	Accuracy (of reading)
Relative humidity measurement 20 to 30°C (68 to 86°F)	0–10%	±3%
	10–90%	±2.5%
	90–99%	±3%

8.3 Moisture specifications

Function	Range	Accuracy (of reading)
Pin moisture	0–99% WME	±5%
Pin-less moisture range	0–99.9	Relative measurement

8 Technical specifications

8.4 Thermal measurement range specifications

Function	IR range	Accuracy (of reading)
IR temperature (8:1 ratio)	-20 to 0°C (-4 to 32°F)	±5°C (±9°F)
	1 to 200°C (33 to 392°F)	Greater of ±3.5% or ±5°C (±9°F)
IR Emissivity	0.95 (fixed)	
Sensor temperature	-28 to 77°C (-18 to 170°F)	±2 °C (3.6°F)

8.5 Vapor pressure specifications

Function	Range	Accuracy (of reading)
Vapor pressure measurement -1 to 60°C (30 to 140°F)	0.0–20.0 kPa	Greater of ±2.0% or 0.2 kPa

8.6 Dew Point Temperature specifications

Function	Range	Accuracy (of reading)
Dew Point Temperature range	-30 to 100 °C (-22 to 199°F)	Calculated from %RH and Air temperature measurements.

8.7 Mixing Ratio specifications

Function	Range	Accuracy (of reading)
Mixing Ratio range	0-999 GPP (0 to 160 g/kg)	Calculated from %RH and Air temperature measurements.

9 Technical support

Website	http://www.flir.com/test
Technical support	T&MSupport@flir.com
Repairs	Repair@flir.com
Phone number	+1 855-499-3662 (toll-free)

10 Warranties

10.1 FLIR Global Limited Lifetime Warranty

A qualifying FLIR Test and Measurement product (the "Product") purchased either directly from FLIR Commercial Systems Inc and affiliates (FLIR) or from an authorized FLIR distributor or reseller that Purchaser registers on-line with FLIR is eligible for coverage under FLIR's Limited Lifetime Warranty, subject to the terms and conditions in this document. This warranty only applies to purchases of Qualifying Products (see below) purchased and manufactured after April 1, 2013.

PLEASE READ THIS DOCUMENT CAREFULLY; IT CONTAINS IMPORTANT INFORMATION ABOUT THE PRODUCTS THAT QUALIFY FOR COVERAGE UNDER THE LIMITED LIFETIME WARRANTY, PURCHASER'S OBLIGATIONS, HOW TO ACTIVATE THE WARRANTY, WARRANTY COVERAGE, AND OTHER IMPORTANT TERMS, CONDITIONS, EXCLUSIONS AND DISCLAIMERS.

1. PRODUCT REGISTRATION. To qualify for FLIR's Limited Lifetime Warranty, Purchaser must fully register the Product directly with FLIR on-line at <http://www.flir.com> within Sixty (60) DAYS of the date the Product was purchased by the first retail customer (the "Purchase Date"). Qualifying PRODUCTS THAT ARE NOT REGISTERED ON-LINE WITHIN SIXTY (60) DAYS OF THE PURCHASE DATE WILL HAVE A LIMITED ONE YEAR WARRANTY FROM DATE OF PURCHASE.

2. QUALIFYING PRODUCTS. Upon registration, Test and Measurement products that qualify for coverage under FLIR's Limited Lifetime Warranty are: MR7x, CM7x, CM8x, DMxx, VP5x not including accessories which may have their own warranty.

3. WARRANTY PERIODS. For purposes of the The Limited Lifetime Warranty, Lifetime is defined as seven years (7) after the product is no longer manufactured, or ten years (10) from date of purchase, whichever is greater. This Warranty is only applicable to the original owner of the Products.

Any Product that is repaired or replaced under warranty is covered under this Limited Lifetime Warranty for one hundred eighty days (180) days from the date of return shipment by FLIR or for the remaining duration of the applicable Warranty Period, whichever is longer.

4. LIMITED WARRANTY. In accordance with the terms and conditions of this Limited Lifetime Warranty, and except as excluded or disclaimed in this document, FLIR warrants, from the Purchase Date, that all fully registered Products will conform to FLIR's published Product specifications and be free from defects in materials and workmanship during the applicable Warranty Period. PURCHASER'S SOLE AND EXCLUSIVE REMEDY UNDER THIS WARRANTY, AT FLIR'S SOLE DISCRETION, IS THE REPAIR OR REPLACEMENT OF

DEFECTIVE PRODUCTS IN A MANNER, AND BY A SERVICE CENTER, AUTHORIZED BY FLIR. IF THIS REMEDY IS ADJUDICATED TO BE INSUFFICIENT, FLIR SHALL REFUND PURCHASER'S PAID PURCHASE PRICE AND HAVE NO OTHER OBLIGATION OR LIABILITY TO BUYER WHATSOEVER.

5. WARRANTY EXCLUSIONS AND DISCLAIMERS. FLIR MAKES NO OTHER WARRANTY OF ANY KIND WITH RESPECT TO THE PRODUCTS. ALL OTHER WARRANTIES, EXPRESS OR IMPLIED, INCLUDING BUT NOT LIMITED TO IMPLIED WARRANTIES OF MERCHANTABILITY, FITNESS FOR A PARTICULAR PURPOSE (EVEN IF PURCHASER HAS NOTIFIED FLIR OF ITS INTENDED USE FOR THE PRODUCTS), AND NON-INFRINGEMENT ARE EXPRESSLY EXCLUDED FROM THIS AGREEMENT.

THIS WARRANTY EXPRESSLY EXCLUDES ROUTINE PRODUCT MAINTENANCE, SOFTWARE UPDATES, AND REPLACEMENT OF MANUALS, FUSES, OR DISPOSABLE BATTERIES. FLIR FURTHER EXPRESSLY DISCLAIMS ANY WARRANTY COVERAGE WHERE THE ALLEGED NONCONFORMITY IS DUE TO NORMAL WEAR AND TEAR, OTHER ALTERATION, MODIFICATION, REPAIR, ATTEMPTED REPAIR, IMPROPER USE, IMPROPER MAINTENANCE, NEGLIGENCE, ABUSE, IMPROPER STORAGE, FAILURE TO FOLLOW ANY PRODUCT INSTRUCTIONS, DAMAGE (WHETHER CAUSED BY ACCIDENT OR OTHERWISE), OR ANY OTHER IMPROPER CARE OR HANDLING OF THE PRODUCTS CAUSED BY ANYONE OTHER THAN FLIR OR FLIR'S EXPRESSLY AUTHORIZED DESIGNEE.

THIS DOCUMENT CONTAINS THE ENTIRE WARRANTY AGREEMENT BETWEEN PURCHASER AND FLIR AND SUPERSEDES ALL PRIOR WARRANTY NEGOTIATIONS, AGREEMENTS, PROMISES AND UNDERSTANDINGS BETWEEN PURCHASER AND FLIR. THIS WARRANTY MAY NOT BE ALTERED WITHOUT THE EXPRESS WRITTEN CONSENT OF FLIR.

6. WARRANTY RETURN, REPAIR AND REPLACEMENT. To be eligible for warranty repair or replacement, Purchaser must notify FLIR within thirty (30) days of discovering of any apparent defect in materials or workmanship. Before Purchaser may return a Product for warranty service or repair, Purchaser must first obtain a returned material authorization (RMA) number from FLIR. To obtain the RMA number Owner must provide an original proof of purchase. For additional information, to notify FLIR of an apparent defect in materials or workmanship, or to request an RMA number, visit <http://www.flir.com>. Purchaser is solely responsible for complying with all RMA instructions provided by FLIR including but not limited to adequately packaging the Product for shipment to FLIR and for all packaging and shipping costs. FLIR will pay for returning to Purchaser any Product that FLIR repairs or replaces under warranty.

10 Warranties

FLIR reserves the right to determine, in its sole discretion, whether a returned Product is covered under Warranty. If FLIR determines that any returned Product is not covered under Warranty or is otherwise excluded from Warranty coverage, FLIR may charge Purchaser a reasonable handling fee and return the Product to Purchaser, at Purchaser's expense, or offer Purchaser the option of handling the Product as a non-warranty return.

7. NON-WARRANTY RETURN. Purchaser may request that FLIR evaluate and service or repair a Product not covered under warranty, which FLIR may agree to do in its sole discretion. Before Purchaser returns a Product for non-warranty evaluation and repair, Purchaser must contact FLIR by visiting <http://www.flir.com> to request an evaluation and obtain an RMA. Purchaser is solely responsible for complying with all RMA instructions provided by FLIR including but not limited to adequately packaging the Product for shipment to FLIR and for all packaging and shipping costs. Upon receipt of an authorized non-warranty return, FLIR will evaluate the Product and contact Purchaser regarding the feasibility of and the costs and fees associated with Purchaser's request. Purchaser shall be responsible for the reasonable cost of FLIR's evaluation, for the cost of any repairs or services authorized by Purchaser, and for the cost of repackaging and returning the Product to Purchaser.

Any non-warranty repair of a Product is warranted for one hundred eighty days (180) days from the date of return shipment by FLIR to be free from defects in materials and workmanship only, subject to all of the limitations, exclusions and disclaimers in this document.

10.2 FLIR Test and Measurement Limited 2 Year Warranty

A qualifying FLIR Test and Measurement product (the "Product") purchased either directly from FLIR Commercial Systems Inc and affiliates (FLIR) or from an authorized FLIR distributor or reseller that Purchaser registers on-line with FLIR is eligible for coverage under FLIR's Limited Warranty, subject to the terms and conditions in this document. This warranty only applies to purchases of Qualifying Products (see below) purchased and manufactured after April 1, 2013.

PLEASE READ THIS DOCUMENT CAREFULLY; IT CONTAINS IMPORTANT INFORMATION ABOUT THE PRODUCTS THAT QUALIFY FOR COVERAGE UNDER THE LIMITED WARRANTY, PURCHASER'S OBLIGATIONS, HOW TO ACTIVATE THE WARRANTY, WARRANTY COVERAGE, AND OTHER IMPORTANT TERMS, CONDITIONS, EXCLUSIONS AND DISCLAIMERS.

1. PRODUCT REGISTRATION. To qualify for FLIR's Limited Warranty, Purchaser must fully register the Product directly with FLIR on-line at <http://www.flir.com> within Sixty (60) DAYS of the date the Product was purchased by the first retail customer (the "Purchase Date"). Qualifying PRODUCTS THAT ARE NOT REGISTERED ON-LINE

WITHIN SIXTY (60) DAYS OF THE PURCHASE DATE WILL HAVE A LIMITED ONE YEAR WARRANTY FROM DATE OF PURCHASE.

2. QUALIFYING PRODUCTS. Upon registration, Test and Measurement products that qualify for coverage under FLIR's Limited Warranty are: VS70 Videoscope, VSAxx Articulation Camera, VSCxx Camera, VSSxx Probe Spool, VST handset, MR02 Pin Extension Probe, and TAxX not including accessories which may have their own warranty.

3. WARRANTY PERIODS. The applicable Limited Warranty Period measured from the Purchase data are:

Products	Limited Warranty Period
VS70, VSAxx, VSCxx, VSSxx, VST, MR02, TAxX	TWO (2) Years

Any Product that is repaired or replaced under warranty is covered under this Limited Warranty for one hundred eighty days (180) days from the date of return shipment by FLIR or for the remaining duration of the applicable Warranty Period, whichever is longer.

4. LIMITED WARRANTY. In accordance with the terms and conditions of this Limited Warranty, and except as excluded or disclaimed in this document, FLIR warrants, from the Purchase Date, that all fully registered Products will conform to FLIR's published product specifications and be free from defects in materials and workmanship during the applicable Warranty Period. PURCHASER'S SOLE AND EXCLUSIVE REMEDY UNDER THIS WARRANTY, AT FLIR'S SOLE DISCRETION, IS THE REPAIR OR REPLACEMENT OF DEFECTIVE PRODUCTS IN A MANNER, AND BY A SERVICE CENTER, AUTHORIZED BY FLIR. IF THIS REMEDY IS ADJUDICATED TO BE INSUFFICIENT, FLIR SHALL REFUND PURCHASER'S PAID PURCHASE PRICE AND HAVE NO OTHER OBLIGATION OR LIABILITY TO BUYER WHATSOEVER.

5. WARRANTY EXCLUSIONS AND DISCLAIMERS. FLIR MAKES NO OTHER WARRANTY OF ANY KIND WITH RESPECT TO THE PRODUCTS. ALL OTHER WARRANTIES, EXPRESS OR IMPLIED, INCLUDING BUT NOT LIMITED TO IMPLIED WARRANTIES OF MERCHANTABILITY, FITNESS FOR A PARTICULAR PURPOSE (EVEN IF PURCHASER HAS NOTIFIED FLIR OF ITS INTENDED USE FOR THE PRODUCTS), AND NON-INFRINGEMENT ARE EXPRESSLY EXCLUDED FROM THIS AGREEMENT.

THIS WARRANTY EXPRESSLY EXCLUDES ROUTINE PRODUCT MAINTENANCE, SOFTWARE UPDATES, AND REPLACEMENT OF FUSES, OR DISPOSABLE BATTERIES. FLIR FURTHER EXPRESSLY DISCLAIMS ANY WARRANTY COVERAGE WHERE THE ALLEGED NONCONFORMITY IS DUE TO NORMAL WEAR AND TEAR, OTHER ALTERATION, MODIFICATION, REPAIR, ATTEMPTED REPAIR, IMPROPER USE, IMPROPER

MAINTENANCE, NEGLIGENCE, ABUSE, IMPROPER STORAGE, FAILURE TO FOLLOW ANY PRODUCT INSTRUCTIONS, DAMAGE (WHETHER CAUSED BY ACCIDENT OR OTHERWISE), OR ANY OTHER IMPROPER CARE OR HANDING OF THE PRODUCTS CAUSED BY ANYONE OTHER THAN FLIR OR FLIR'S EXPRESSLY AUTHORIZED DESIGNEE.

THIS DOCUMENT CONTAINS THE ENTIRE WARRANTY AGREEMENT BETWEEN PURCHASER AND FLIR AND SUPERSEDES ALL PRIOR WARRANTY NEGOTIATIONS, AGREEMENTS, PROMISES AND UNDERSTANDINGS BETWEEN PURCHASER AND FLIR. THIS WARRANTY MAY NOT BE ALTERED WITHOUT THE EXPRESS WRITTEN CONSENT OF FLIR.

6. WARRANTY RETURN, REPAIR AND REPLACEMENT.

To be eligible for warranty repair or replacement, Purchaser must notify FLIR within thirty (30) days of discovering of any apparent defect in materials or workmanship. Before Purchaser may return a Product for warranty service or repair, Purchaser must first obtain a returned material authorization (RMA) number from FLIR. To obtain the RMA number Owner must provide an original proof of purchase. For additional information, to notify FLIR of an apparent defect in materials or workmanship, or to request an RMA number, visit <http://www.flir.com>. Purchaser is solely responsible for complying with all RMA instructions provided by FLIR including but not limited to adequately packaging the Product for shipment to FLIR and for all packaging and shipping costs. FLIR will pay for returning to Purchaser any Product that FLIR repairs or replaces under warranty.

FLIR reserves the right to determine, in its sole discretion, whether a returned Product is covered under Warranty. If FLIR determines that any returned Product is not covered under Warranty or is otherwise excluded from Warranty coverage, FLIR may charge Purchaser a reasonable handling fee and return the Product to Purchaser, at Purchaser's expense, or offer Purchaser the option of handling the Product as a non-warranty return.

7. NON-WARRANTY RETURN. Purchaser may request that FLIR evaluate and service or repair a Product not covered under warranty, which FLIR may agree to do in its sole discretion. Before Purchaser returns a Product for non-warranty evaluation and repair, Purchaser must contact FLIR by visiting <http://www.flir.com> to request an evaluation and obtain an RMA. Purchaser is solely responsible for complying with all RMA instructions provided by FLIR including but not limited to adequately packaging the Product for shipment to FLIR and for all packaging and shipping costs. Upon receipt of an authorized non-warranty return, FLIR will evaluate the Product and contact Purchaser regarding the feasibility of and the costs and fees associated with Purchaser's request. Purchaser shall be responsible for the reasonable cost of FLIR's evaluation, for the cost of any repairs or services authorized by Purchaser, and for the cost of repackaging and returning the Product to Purchaser.

Any non-warranty repair of a Product is warranted for one hundred eighty days (180) days from the date of return shipment by FLIR to be free from defects in materials and workmanship only, subject to all of the limitations, exclusions and disclaimers in this document.

A note on the technical production of this publication

This publication was produced using XML — the eXtensible Markup Language. For more information about XML, please visit <http://www.w3.org/XML/>

A note on the typeface used in this publication

This publication was typeset using Linotype Helvetica™ World. Helvetica™ was designed by Max Miedinger (1910–1980)

LOEF (List Of Effective Files)

T501022.xml; en-US; AE; 10036; 2013-11-22



Corporate Headquarters

FLIR Systems, Inc.
27700 SW Parkway Ave.
Wilsonville, OR 97070
USA
Telephone: +1-503-498-3547

Website

<http://www.flir.com>

Customer support

<http://support.flir.com>

Publ. No.: T559822
Release: AE
Commit: 10036
Head: 10036
Language: en-US
Modified: 2013-11-22
Formatted: 2013-11-22



T559822

Distributed by:

Reduction Revolution Pty Ltd

www.reductionrevolution.com.au/FLIR