

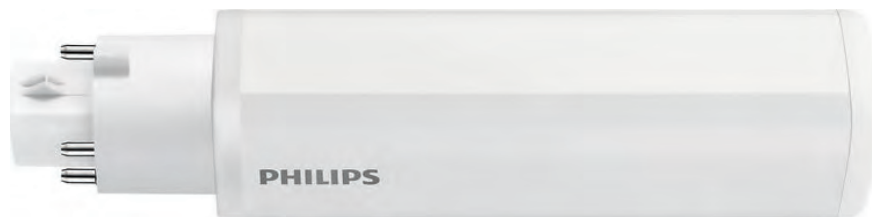

Distributed by:  
Reduction Revolution Pty Ltd  
[www.reductionrevolution.com.au/LED](http://www.reductionrevolution.com.au/LED)



# CorePro LED PLC 4P

## CorePro LED PLC 6.5W 840 4P G24q-2

The CorePro LED PLC 4P integrates a LED light source into a traditional fluorescent form factor. This product is the ideal solution for uplampping in general lighting applications: it meets basic lighting requirements, offers significant energy savings, and is environmentally friendly.

### Product data

General Information	
Cap-Base	G24Q-2 [ G24q-2]
EU RoHS compliant	Yes
Nominal Lifetime (Nom)	30000 h
Switching Cycle	50000X
Light Technical	
Color Code	840 [ CCT of 4000K]
Beam Angle (Nom)	120 °
Luminous Flux (Nom)	700 lm
Color Designation	Cool White (CW)
Correlated Color Temperature (Nom)	4000 K
Luminous Efficacy (rated) (Nom)	92.31 lm/W
Color Consistency	<6
Color Rendering Index (Nom)	83
LLMF At End Of Nominal Lifetime (Nom)	70 %
Operating and Electrical	
Input Frequency	30000-80000 Hz
Power (Nom)	6.5 W
Lamp Current (Max)	300 mA
Lamp Current (Min)	150 mA
Starting Time (Nom)	0.5 s

Warm Up Time to 60% Light (Nom)	0.5 s
Power Factor (Nom)	0.9
Voltage (Nom)	20-50 V
Temperature	
T-Ambient (Max)	35 °C
T-Ambient (Min)	-20 °C
T-Storage (Max)	65 °C
T-Storage (Min)	-40 °C
T-Case Maximum (Nom)	66 °C
Controls and Dimming	
Dimmable	No
Approval and Application	
Energy Efficiency Label (EEL)	A+
Energy Saving Product	Yes
Approval Marks	TUV CE marking RoHS compliance KEMA Keur certificate

# CorePro LED PLC 4P

Energy Consumption kWh/1000 h	9 kWh
<b>Product Data</b>	
Full product code	871869654121000
Order product name	CorePro LED PLC 6.5W 840 4P G24q-2
EAN/UPC - Product	8718696541210
Order code	929001201102

Numerator - Quantity Per Pack	1
Numerator - Packs per outer box	10
Material Nr. (12NC)	929001201102
Net Weight (Piece)	0.078 kg

## Dimensional drawing

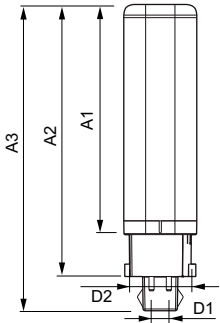

Product	D1	D2	A1	A2	A3
CorePro LED PLC 6.5W 840 4P G24q-2	24.3 mm	28.4 mm	105.8 mm	125 mm	140.6 mm

## LEDtube PLC 6.5W G24q-2/840 4P

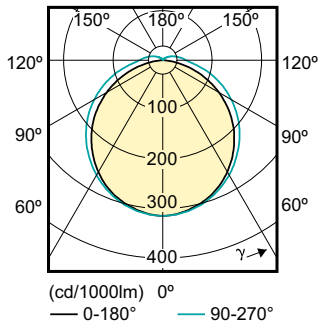

**Distributed by:**  
 Reduction Revolution Pty Ltd  
[www.reductionrevolution.com.au/LED](http://www.reductionrevolution.com.au/LED)

# CorePro LED PLC 4P

## Lifetime

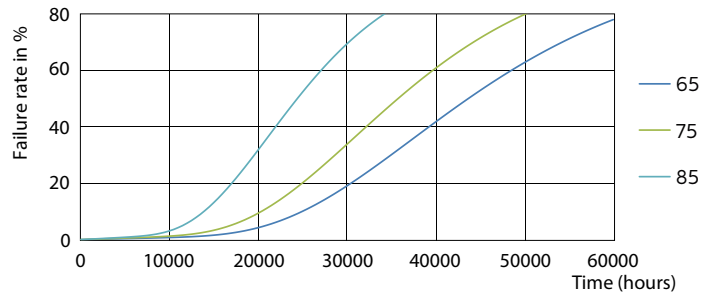
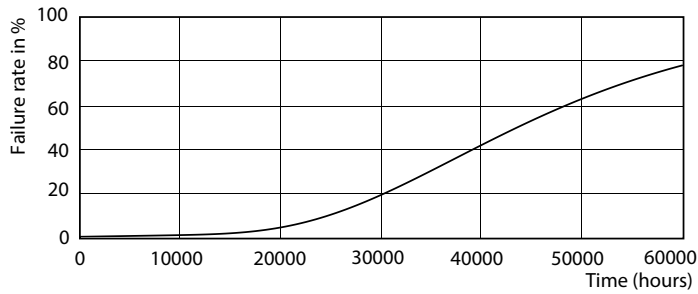

LEDtube PLC 100mm 7W G24Q-2 830 650lm

LEDtube PLC 100mm 7W G24Q-2 830 650lm

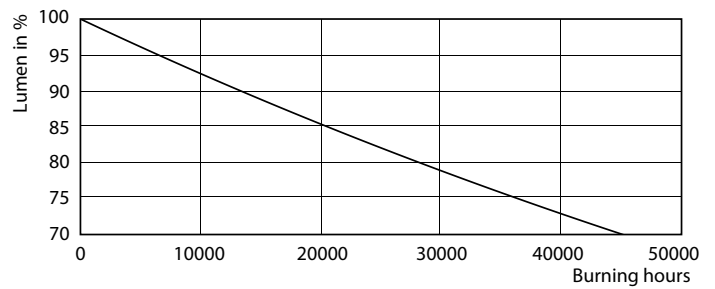
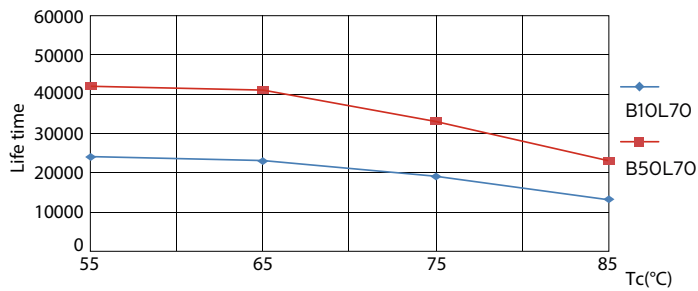

LEDtube PLC 100mm 7W G24Q-2 830 650lm

LEDtube PLC 100mm 7W G24Q-2 830 650lm

