

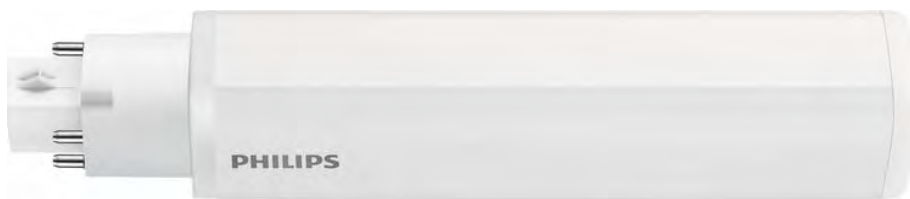

Distributed by:
 Reduction Revolution Pty Ltd
www.reductionrevolution.com.au/LED



CorePro LED PLC 4P

CorePro LED PLC 9W 840 4P G24q-3

The CorePro LED PLC 4P integrates a LED light source into a traditional fluorescent form factor. This product is the ideal solution for uplamping in general lighting applications: it meets basic lighting requirements, offers significant energy savings and is environmentally friendly.

Product data

General information	
Cap base	G24Q-3 [G24q-3]
EU RoHS compliant	Yes
Nominal lifetime (nom.)	30000 h
Switching cycle	50000
	Sphere
Tier	CorePro
Light technical	
Colour Code	840 [CCT of 4,000 K]
Technical Beam Angle (Nom)	120 °
Lamp Luminous Flux 25°C EL (Nom)	1000 lm
Colour Designation	Cool White (CW)
Colour Temperature, horizontal (Nom)	4000 K
Lamp Luminous Efficacy EM (Nom)	100.00 lm/W
Colour consistency	<6
Colour Rendering Index, horiz (Nom)	83
LLMF at end of nominal lifetime (nom.)	70 %
Operating and electrical	
Input frequency	30000-80000 Hz
Power (Rated) (Nom)	9 W
Lamp current (max.)	400 mA

Lamp current (min.)	250 mA
Starting time (nom.)	0.5 s
Warm-up time to 60% light (nom.)	0.5 s
Power factor (nom.)	0.9
Voltage (Nom)	20-50 V
Temperature	
T-ambient (max.)	35 °C
T-ambient (min.)	-20 °C
T storage (max.)	65 °C
T storage (min.)	-40 °C
T-Case maximum (nom.)	76 °C
Controls and dimming	
Dimmable	No
Approval and application	
Energy Efficiency Class	F
Energy-saving product	Yes

CorePro LED PLC 4P

Approval marks	TUV
Approval marks	CE marking RoHS compliance KEMA Keur certificate
Energy consumption kWh/1,000 hours	9 kWh 403551
Product data	
Full product code	871869654117300
Order product name	CorePro LED PLC 9W 840 4P G24q-3

EAN/UPC – product	8718696541173
Order code	929001200902
SAP numerator – quantity per pack	1
Local code description	CorePro LED PLC 9W 840 4P G24q-3
Numerator – packs per outer box	10
SAP material	929001200902
Net Weight (Piece)	0.088 kg

Dimensional drawing

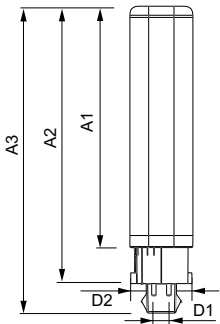

CorePro LED PLC 9W 840 4P G24q-3

Product	D1	D2	A1	A2	A3
CorePro LED PLC 9W 840 4P G24q-3	24.3 mm	28.4 mm	128.8 mm	148 mm	163.6 mm

Photometric data

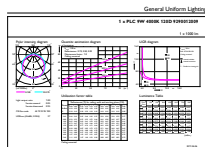

General Information 14 Recycling 15 Page 16

LEDtube PLC 100mm 9W G24Q-3 840 1000lm

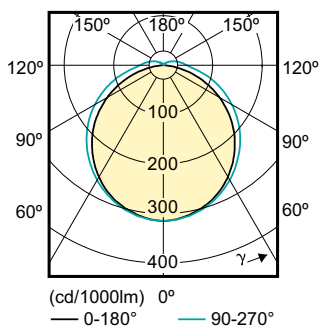

Distributed by:
Reduction Revolution Pty Ltd
www.reductionrevolution.com.au/LED

CorePro LED PLC 4P

Lifetime

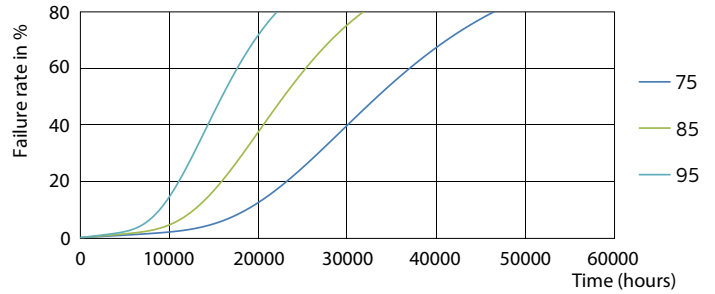
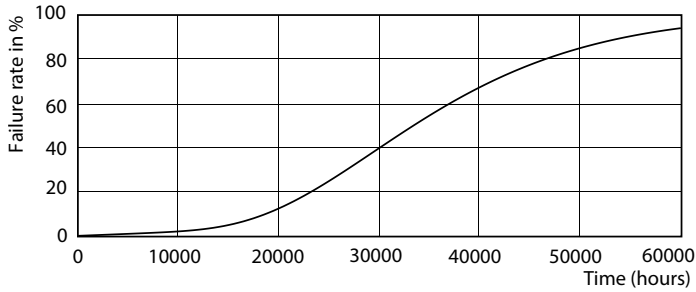

LEDtube PLC 100mm 9W G24Q-3 830 950lm

LEDtube PLC 100mm 9W G24Q-3 830 950lm

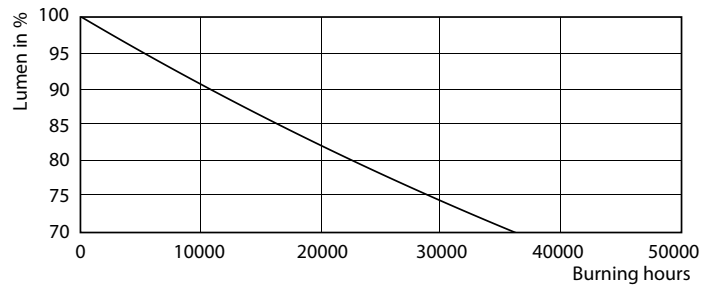
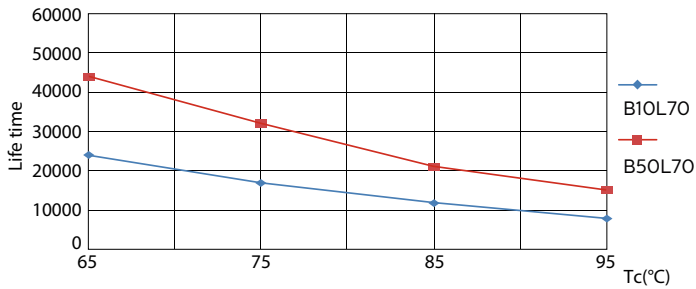

LEDtube PLC 100mm 9W G24Q-3 830 950lm

LEDtube PLC 100mm 9W G24Q-3 830 950lm

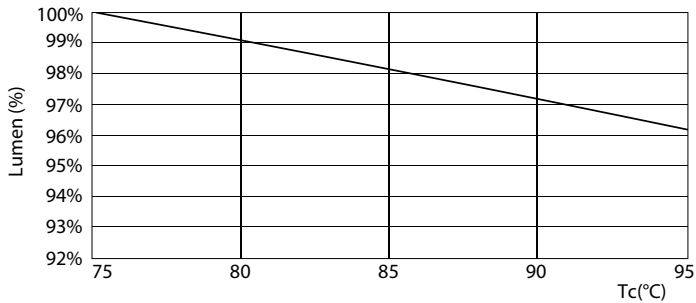

LEDtube PLC 100mm 9W G24Q-3 830 950lm

