

204518

204518

| | | | |
|--|---|--|---|
| | ø88×56.6mm | | max. 12m(<24°C) wall mount max. 12m(<24°C) ceiling mount |
| | 220-240 V~ 50/60Hz | | wall: 1.8-2.5m ceiling: 2.2-4m |
| | max. 1200 W | | 10 sec - 15 min |
| | max. 300 W | | 3-2000 Lux |
| | max. 180° wall mount max. 360° ceiling mount | | IP44 |

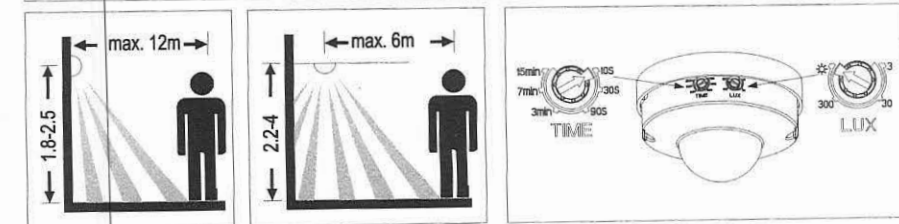
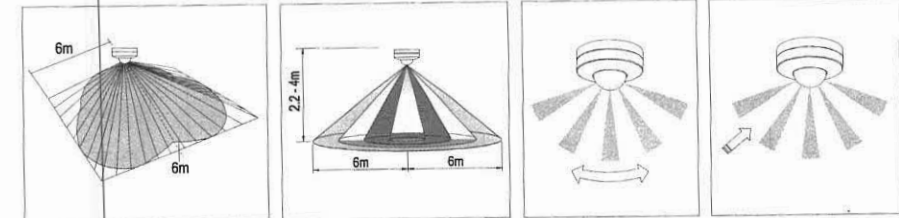
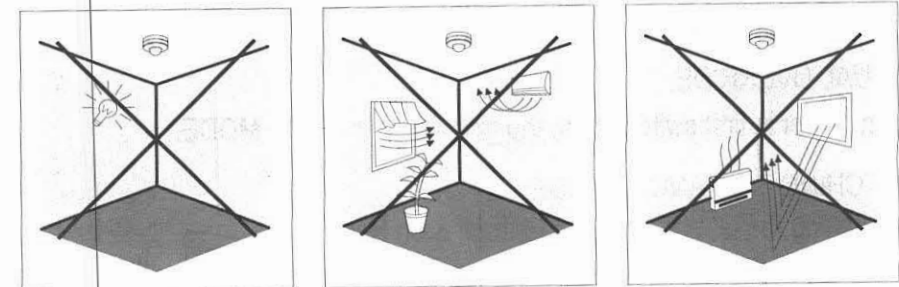
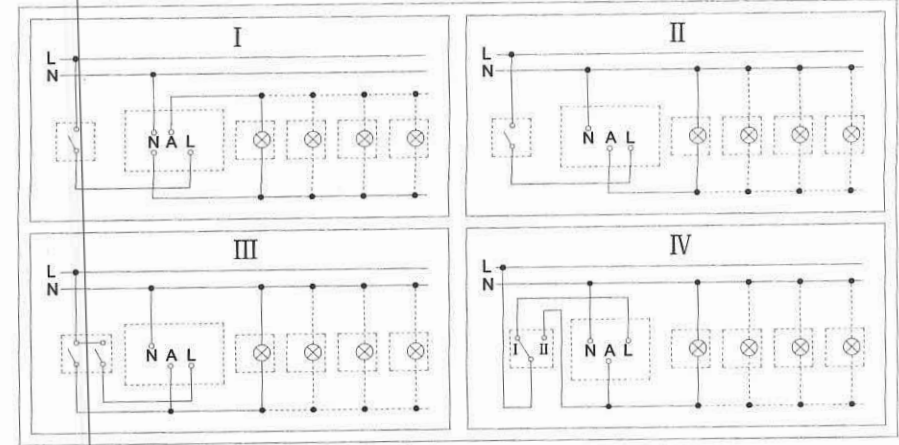
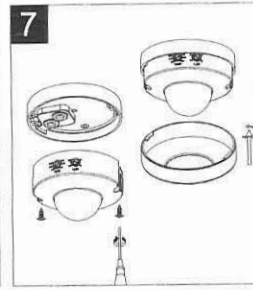
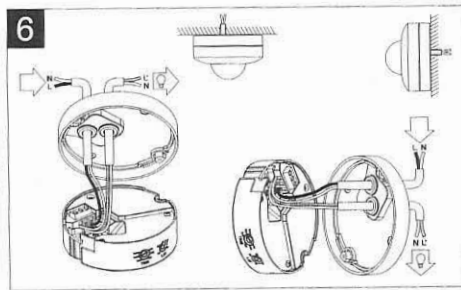
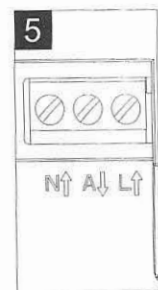
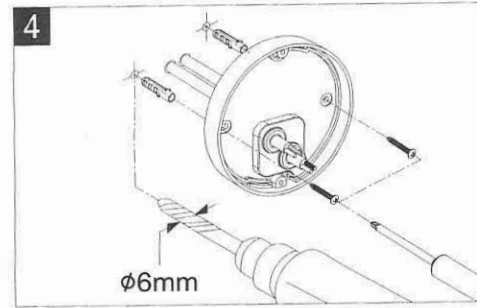
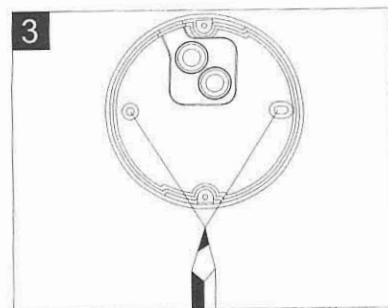
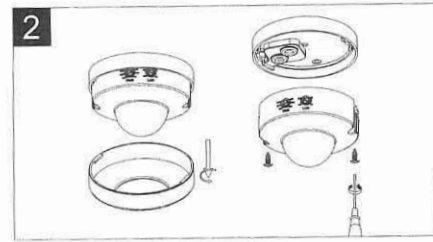
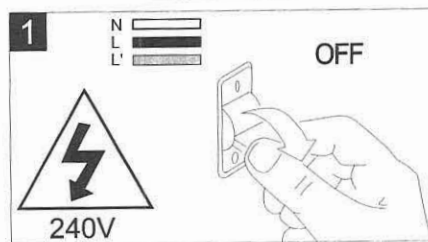

Distributed by:
Reduction Revolution Pty Ltd
www.reductionrevolution.com.au/LED

www.eglo.com.au

www.eglo.com.au

204518

FUNCTION:

- **LUX:** The LUX knob controls the ambient light level at which the sensor will switch on. At the “sun” position, the sensor will operate 24 hours a day. At the “3” position, the sensor will only operate at night. You can set the sensor to operate at the desired lux level by adjusting the LUX knob.
- **TIME:** The TIME knob controls how long the light/s will stay on after movement is detected. Once the light has been triggered by the PIR sensor, any subsequent detection will start the timed period again from the beginning.

MANUAL OVERRIDE:

When power is first switched on, the unit will be in AUTO MODE.

SWITCHING TO MANUAL MODE:

1. Switching the ON/OFF main switch off & on twice in about 3 seconds, the unit will automatically change into MANUAL MODE.



SWITCHING TO AUTO MODE:

1. Switching the ON/OFF main switch off then on after 3 seconds, the sensor will change into AUTO MODE.
2. Keep the main switch on, the sensor will switch to AUTO MODE after 8 hours.

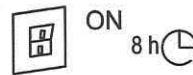

Distributed by:
Reduction Revolution Pty Ltd
www.reductionrevolution.com.au/LED