

# FLOS

## Viscontea - Specification Sheet

by Achille and Pier Giacomo Castiglioni, 1960

Mounting	Ceiling Pendant
Lamp (Bulb) Description	1 x 72W BT-15 ECO Halogen (Included)
Canopy Dimension	Diameter 5.75" - 1.40" high
Environment	Indoor - Dry Location
Dimming	Phase-cut Dimming / Triac Type
Finish	White
Technical and Product Description	VISCONTEA suspension lamp providing diffused light. White powder coated internal steel structure sprayed with a unique "cocoon" resin to create the diffuser which is then protected by a transparent sprayed on finish.

### Electrical

Voltage	120
Switching	NA
IP Rating	IP20

### Physical

Cord Length (inches)	96" - White (Cord length can be shortened during installation)
Construction Material	Plastic
Weight	3.75 lbs



○ FU800109 White

### Dimensional Image

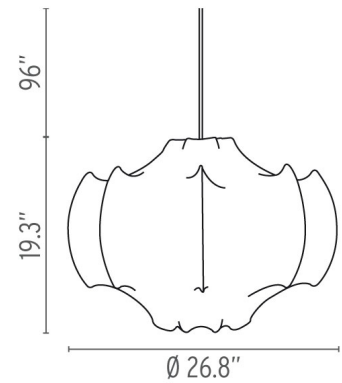

### Certifications



### Lamping (Bulb)



72W BT-15 ECO Halogen

### Lamping (Bulb)



LED018 PRO-T38LED 14W 120V E26 2700K  
DIMM - 1800lm - CRI80 Additional

### Lamping (Bulb)



LED031 PRO-T38LED 14W 120V E26 3000K  
Dimmable - 1800lm - CRI80- Additional