

• ABOUT US •

Driven by the passion for innovation, we at Dr Trust endeavour to provide our customers with the latest medical inventions with an objective to promote good health and wellness all around the world. All the medical devices and health monitors provided by Dr Trust are supported by accurate, latest and ground breaking technologies, innovated at our headquarter in NY, USA. All our products adhere to the most stringent CE and FDA guidelines and are strongly recommended by doctors and health practitioners. Our products are designed in the utmost exemplary ways to ensure that their accuracy and convenience are unrivalled. The ease of their use and operation makes them even more suitable for users of all age groups.

Dr Trust strives to enhance the quality of lifestyle by providing with the most trusted and innovative health care and wellness products. Being a renowned global leader in health care products, Dr Trust ensures that our technically efficient team works dynamically and tirelessly to provide the best of the medical devices to our clients. The products that we have to offer are suitably designed for use at homes, laboratories and hospitals.

Our ground breaking solutions allow you to monitor your health in the easiest ways possible. In today's era when all of our lives are too hassled to handle, it becomes a bit difficult to pay attention to our health. But it has now become easier with the coming of the monitoring devices which can be

We bring to you a variety of best self medical devices, trusted and used by Doctors, medical professionals and home users all over the world.

Dr Trust Paediatric BP Monitor-111

• QUICK STARTUP GUIDE •

Step 1

Check batteries and insert the air tube from the cuff into the air jack.

Step 2

Before starting the measurement, select mode and make settings for user no., time, and date etc.

Step 3

Have your child sit with his or her feet flat on the floor and back against a chair.

Step 4

Extend your child's arm and support it on a flat surface. Position the cuff on your child's arm about 1-2 inches above his or her elbow and wrap it snugly.

Step 5

After the cuff has been appropriately positioned, press the ON/OFF button and the symbols on the display light up for a few seconds to indicate the device is ready.

Step 6

The monitor displays your blood pressure and pulse rate with flashing the heartbeat symbol.



● TABLE OF CONTENT ●

| | |
|--|-----------|
| 1. Introduction | 4 |
| 1.1. Features of Paediatric BP Monitor-111 | |
| 1.2. Important information about self-measurement | |
| 2. Important information on the subject of blood-pressure and its measurement | 5 |
| 2.1. How does high/low blood-pressure arise? | |
| 2.2. Which values are normal? | |
| 3. The various components of the blood-pressure monitor | 7 |
| 4. Putting the blood-pressure monitor into operation | 9 |
| 4.1. Inserting the batteries | |
| 4.2. Reading the set date | |
| 4.3. Language selection, user selection and setting the time / date | |
| 5. CARRYING OUT A MEASUREMENT | 12 |
| 5.1. Before the measurement | |
| 5.2. Common sources of error | |
| 5.3. Fitting the cuff | |
| 5.4. Measuring procedure | |
| 5.5. Discontinuing a measurement | |
| 5.6. Memory – storage and recall of the measurements | |
| 5.7. Memory – cancellation of all measurements attention! | |

| | |
|--|-----------|
| 6. APPEARANCE OF THE HEART ARRHYTHMIA INDICATOR FOR EARLY DETECTION | 18 |
| 7. ERROR MESSAGES /MALFUNCTIONS | 18 |
| 8. CARE AND MAINTENANCE, RECALIBRATION | 21 |
| 9. BATTERY LIFE | 21 |
| 10. SAFEY, CARE AND DISPOSAL | 21 |
| 11. REFERENCE TO STANDARDS | 23 |
| 12. TECHNICAL SPECIFICATIONS | 23 |
| 13. MANUFACTURER DECLARATIONS | 25 |
| 14. CONTACT US | 31 |
| 15. ABOUT US | 32 |



● 1. INTRODUCTION ●

1.1. Features of Paediatric BP Monitor-111

Dr Trust Paediatric BP Monitor-111 is a fully automatic, digital blood-pressure measuring device for use on the upper arm, which enables very fast and reliable measurement of the systolic and diastolic blood-pressure as well as the pulse frequency by way of the oscillometric method of measurement. The device offers very high and clinical tested measurement accuracy and has been designed to provide maximum of user-friendliness. However, before using, please read this instruction manual carefully and keep it in a safe place. For further questions about blood-pressure and its measurement, please contact your doctor.

⚠ Attention

1.2. Important information about measurement

- Substitution of a different component might result in measurement error.
- Cuff is replaceable only by an original.
- Do not use with neonatal patients.
- It will cause harmful injury to the patient or effect the blood pressure due to connection tubing kinking.
- Too frequent measurements can cause injury to the patient due to blood flow interference.
- The application of the cuff over a wound can cause further injury.
- The application of the cuff and its pressurization on any limb where intravascular access or therapy, or an arteriovenous (A-V) shunt, is present because of temporary interference to blood flow and could result in injury to the patient.

- Do not let the cuff and its pressurization on the arm on the side of a mastectomy
- The need to check that operation of the automated sphygmomanometer does not result in prolonged impairment of patient blood circulation.
- Not intended to be used together with HF surgical equipment.
- **Do not forget:** self-measurement means control, not diagnosis or treatment. Unusual values must always be discussed with your doctor. Under no circumstances should you alter the dosages of any drugs prescribed by your doctor.
- The pulse display is not suitable for checking the frequency of heart pacemakers!
- In cases of cardiac irregularity (Arrhythmia), measurements made with this instrument should only be evaluated after consultation with the doctor.

Electromagnetic interference

The device contains sensitive electronic components (Microcomputer). Therefore, avoid strong electrical or electromagnetic fields in the direct vicinity of the device (e.g. mobile telephones, microwave cookers). These can lead to temporary impairment of the measuring accuracy.

● 2. IMPORTANT INFORMATION ABOUT BLOOD-PRESSURE AND ITS MEASUREMENT ●

2.1. How does high/low blood-pressure arise?

The level of blood-pressure is determined in a part of the brain, the so-called circulatory center, and adapted to the respective situation by way of feedback via the nervous system.



To adjust the blood-pressure, the strength and frequency of the heart (Pulse), as well as the width of circulatory blood vessels is altered. The latter is affected by way of fine muscles in the blood-vessel walls. The level of arterial blood-pressure changes periodically during the heart activity: During the «blood ejection» (Systole) the value is maximal (systolic blood-pressure value), at the end of the heart's «rest period» (Diastole) minimal (diastolic blood-pressure value). The blood-pressure values must lie within certain normal ranges in order to prevent particular diseases.

2.2. Which values are normal?

Please keep a record of the level of your blood pressure by carrying out regular self-measurements at specific times of the day. Show these values to your doctor. Never use the results of your measurements to alter independently the drug doses prescribed by your doctor.

Table for classifying blood-pressure values (unit: mmHg) according to World Health Organization:

| Range | Systolic Blood-pressure | Diastolic Blood-pressure | Measures |
|---------------------------------|-------------------------|--------------------------|-------------------------------|
| Blood pressure optimum | between 100 and 120 | between 60 and 80 | Self Check |
| Blood pressure normal | between 120 and 129 | between 80 and 84 | Self Check |
| Blood pressure slightly high | between 130 and 139 | between 85 and 89 | Consult your doctor |
| Blood pressure too high | between 140 and 159 | between 90 and 99 | Seek medical advice |
| Blood pressure far too high | between 160 and 179 | between 100 and 109 | Seek medical advice |
| Blood pressure dangerously high | Higher than 180 | Higher than 110 | Urgently seek medical advice! |

Further information

- If your values are mostly standard under resting conditions but exceptionally high under conditions of physical or psychological stress, it is possible that you are suffering from so-called «labile hypertension». Please consult your doctor if you suspect that this might be the case.
- Correctly measured diastolic blood-pressure values above 120mmHg require immediate medical treatment



3. THE VARIOUS COMPONENTS OF THE BLOOD-PRESSURE MONITOR

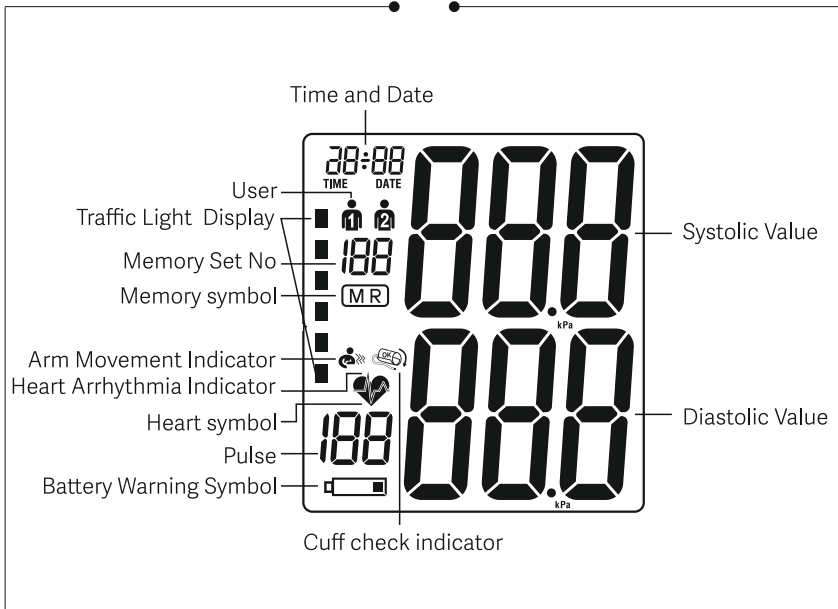



4. PUTTING THE BLOOD-PRESSURE MONITOR INTO OPERATION

4.1. Inserting the batteries

- Insert the batteries (4 x size AAA1.5V), thereby observing the indicated polarity.
- If the battery warning  icon appears in the display, the batteries remain 20% power to warn user the batteries will be run out.
- If the battery warning  icon appears in the display, the batteries are empty and must be replaced by new ones immediately.

⚠ Attention

- After the battery warning  icon appears, the device is blocked until the batteries have been replaced.
- Please use «AAA» Long-Life or Alkaline 1.5V Batteries. The use of 1.2V Accumulators is not recommended.
- If the blood-pressure monitor is left unused for long periods, please remove the batteries from the device.

4.2. Reading the set date

Please press the TIME button and the date will be shown in the display.



4.3. User selection and setting the time / date

User selection: This advanced blood pressure monitor allows you to track blood pressure readings for 2 individuals independently

- a) Before measurement, make sure you set the unit for the intended user. The unit can track results for 2 individuals. (User 1, User 2)
- b) Press the TIME button for at least 3 seconds. The display now indicates the set user, during which the set user blink, to confirm, press ON/OFF button.
- c) Click the MEMORY button to select User.
- d) We suggest the first person to take their pressure to be User 1.

Setting the time, date

This blood-pressure monitor incorporates an integrated clock with date display. This has the advantage, that at each measurement procedure, not only the blood-pressure values are stored, but also the exact moment of the measurement. After new batteries have been inserted, the clock begins to run TIME 12:00 and DATE 1-01. You must then re-enter the date and current time. For this, please proceed as follows.

1. Press the TIME button for at least 3 seconds firstly, user icon will blink. Then press TIME button again the display now indicates the set year, during which the four characters blink.
2. The correct year can be entered by pressing the MEMORY button
3. Press the TIME button again. The display now switches to the current date, during which the first character (month) blinks.
4. The corresponding month can now be entered by pressing the MEMORY button.

5. Press the TIME button again. The last two characters (day) are now blinking
6. The corresponding day can now be entered by pressing the MEMORY button.
7. Press the TIME button again. The display now switches to the current time, during which the first character (Hour) blinks
8. The corresponding hour can now be entered by pressing the MEMORY button.
9. Press the TIME button again. The last two characters (Minutes) now blink.
10. The exact time can now be entered by pressing the MEMORY button
11. Press TIME button: the unit of measurement will flash.
12. Press the "MEMORY to set the unit of measurement (mmHg or kPa)
13. Once you have made your settings, press the TIME button (or TIME / DATE or TIME). The setting is confirmed, and the clock starts running.
14. Now after all settings have been made, press the TIME button once again. The date is briefly displayed and then the time. The input is now confirmed, and the clock begins to run.

Further Information

With each press of the button (TIME, MEMORY) one input is made (e. g. switching over from hours to minutes mode or altering the value by +1). However, if you keep the respective button depressed, you can switch more quickly to find the desired value, respectively.



5. CARRYING OUT A MEASUREMENT

5.1. Before the measurement

- Avoid eating, smoking as well as all forms of exertion directly before the measurement. All these factors influence the measurement result. Try and find time to relax by sitting in an armchair in a quite atmosphere for about ten minutes before the measurement.
- Measure always on the same arm (normally left).
- Attempt to carry out the measurements regularly at the same time of day, since the blood-pressure changes during the day.

5.2. Common sources of error

Note: Comparable blood-pressure measurements always require the same conditions! These are normally always quiet conditions.

- All efforts by the patient to support the arm can increase the blood-pressure. Make sure you are in a comfortable, relaxed position and do not activate any of the muscles in the measurement arm during the measurement. Use a cushion for support if necessary.
- The performance of the automated sphygmomanometer can be affected by extremes of temperature, humidity, and altitude.
- Avoid compression or restriction of the connection tubing.
- A loose cuff causes false measurement values.
- With repeated measurements, blood accumulates in the respective arm, which can lead to false results. Correctly executed blood-pressure measurements should therefore first be repeated after a 5-minute pause or after the arm has been held up to allow the accumulated blood to flow away (after at least 3 minutes).

5.3. Fitting the cuff

Insert air connector into air outlet shown in left photo and please make sure the fitting of the air connector completely and properly to avoid air leakage.



- a) The distance between the edge of cuff and the elbow should be approx. 2-3cm
Please update cuff size in the image (17-22cm)

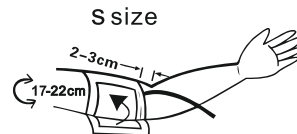

- b) Secure the cuff with the Velcro fastener, so that it lies comfortably and not too tight, whereby 2-finger space should remain between the cuff and the arm.

- c) Lay the arm on a table, with the palm upwards. Support the arm a little with a rest (cushion), so that the cuff rests at about the same height as the heart. Take care, that the cuff lies free. Remain so for 2 minutes sitting quietly, before beginning with the measurement.

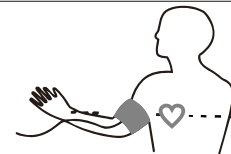





- d) Let legs uncrossed, feet flat on the floor, back and arm supported.

5.4. Measuring procedure

This device enables you to measure blood pressure with cuff deflation.

After the cuff has been appropriately positioned, the measurement can begin:

- a) **ON/OFF:** Press the ON/OFF button, the pump begins to inflate the cuff. In the display, the increasing cuff-pressure is continually displayed. the increasing cuff-pressure is continually displayed.
- 
- b) **Cuff fitting detection:** The icon  will appear and blink during measuring, if cuff is not positioned well.
The icon  will appear during measuring, if cuff is fit well.
- c) **Arm movement detection during measuring:** The icon  will appear, if a movement is detected which may influence accuracy. due to the movement not too serious, the measuring can be continuous (if the movement is too serious, Err5 displayed).
- d) As the cuff inflates, the monitor automatically determines your ideal inflation level. This monitor detects your blood pressure and pulse rate during inflation. the increasing cuff-pressure is continually displayed.

The heartbeat symbol  flashes at every heartbeat. When the device has detected the pulse, the heart symbol in the display begins to blink for every pulse beat. The measured systolic and diastolic blood-pressure values as well as the pulse frequency are now displayed.

Example (Fig.): Systole 126, Diastole 85, Pulse 78

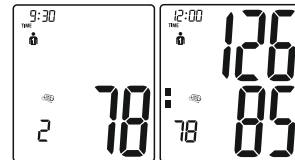

Measured result:

The measured systolic and diastolic blood-pressure values as well as the pulse frequency are now displayed.

Example 1:

Example (Fig.): Systole 126, Diastole 85, Pulse 78
Cuff fit well.



Example 2:

Systole 128, Diastole 70, Pulse 80
arrhythmia



5.5. Discontinuing a measurement

If it is necessary to interrupt a blood pressure measurement for any reason (e.g. the patient feels unwell), the "ON/OFF" power button can be pressed at any time. The device then immediately lowers the cuff-pressure automatically.

5.6. Memory – storage and recall of the measurements

The blood-pressure monitor automatically stores each of 120 measurement values. By pressing the MEMORY button, an average value of the last 3 measurements as well as the last measurement and the further last 119 measurements can be displayed one after the other.

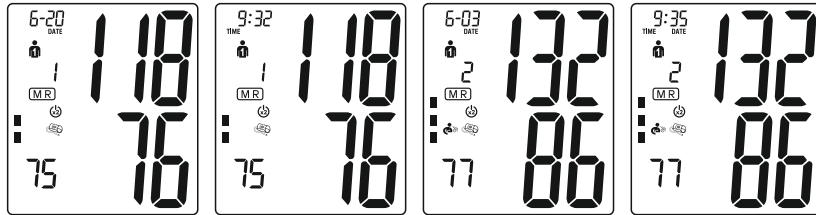

(Average of the last three measurements) (the last measurement) (Values of the measurement before MR1)

5.7. Memory full

Pay attention that the maximum memory capacity is not exceeded. When the memory is full, the old values are automatically overwritten with new ones. When memory is full, the display will show FUL to remind you memory full.

5.8. Memory–cancellation of all measurements Attention!

Before you delete all readings stored in the memory, make sure you will not need refer to the readings later. Keeping a written record is prudent and may provide additional information for your doctor's visit. To delete all stored readings, depress the MEMORY button for at least 5 seconds, the display will show the symbol «CL» and then release the button. To permanently clear the memory, Press the MEMORY button while «CL» is flashing.

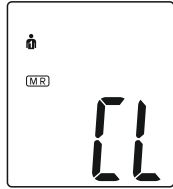

6. APPEARANCE OF THE HEART ARRHYTHMIA INDICATOR FOR EARLY DETECTION

This symbol  indicates that certain pulse irregularities were detected during the measurement.

In this case, the result may deviate from your normal blood pressure – repeat the measurement. In most cases, this is no cause for concern. However, if the symbol appears on a regular basis (e.g., several times a week with measurements taken daily) we advise you to tell your doctor.

Please show your doctor the following explanation:

Information for the doctor on frequent appearance of the Arrhythmia indicator.

This instrument is an oscillometric blood pressure monitor that also analyses pulse frequency during measurement. The instrument is clinically tested. The arrhythmia symbol is displayed after the measurement if pulse irregularities occur during measurement. If the symbol appears more frequently (e.g., several times per week on measurements performed daily) we recommend the patient to seek medical advice.

The instrument does not replace a cardiac examination but serves to detect pulse irregularities at an early stage.

7. ERROR MESSAGES /MALFUNCTIONS

If an error occurs during a measurement, the measurement is discontinued, and a corresponding error code is displayed.

| Error No. | Possible cause(s) |
|-----------|---|
| ERR 1 | No pulse has been detected. |
| ERR 2 | Unnatural pressure impulses influence the measurement result. Reason: The arm was moved during the Measurement (Artefact). |
| ERR 3 | The inflation of the cuff takes too long. The cuff is not correctly seated. |
| ERR 5 | The measured readings indicated an unacceptable difference between systolic and diastolic pressures. Take another reading following directions carefully. Contact you doctor if you continue to get unusual readings. |
| ERR 8 | If pressure is over 290mmHg |

Further Information - The level of blood-pressure is subject to fluctuations even with healthy people. Important thereby is, that comparable measurements always require the same conditions (Quiet conditions)! If, in spite of observing all these factors, the fluctuations are larger than 15mmHg, and/or you hear irregular pulse tones on several occasions, please consult your doctor. For licensing, the device has been subjected to strict clinical tests, by which the computer program used to measure the blood-pressure values was tested by experienced specialist doctors in Germany. The same computer program is used in every individual device and has thus also been clinically tested. The manufacture of the devices takes place according to the terms of the European standard for blood-pressure measuring devices (see technical data) You must consult your specialist dealer or chemist if there are technical problems with the blood-pressure instrument. Never attempt to repair the instrument yourself! Any unauthorized opening of the instrument invalidates all guarantee claims!

Other possible malfunctions and their elimination

If problems occur when using the device, the following points should be checked and if necessary, the corresponding measures are to be taken:



| Malfunction | Remedy |
|---|--|
| The display remains empty when the instrument is switched on although the batteries are in place. | <ol style="list-style-type: none"> 1. Check batteries for correct polarity and if necessary, insert correctly. 2. If the display is unusual, re-insert batteries or exchange them. |
| The device frequently fails to measure the blood pressure values, or the values measured are too low (too high). | <ol style="list-style-type: none"> 1. Check the positioning of the cuff. 2. Measure the blood-pressure again in peace and quiet under observance of the details made under point 5. |
| Every measurement produces a different value although the instrument functions normally and the values displayed are normal | <ol style="list-style-type: none"> 1. Please read the following information and the points listed under «Common sources of error». Repeat the measurement. <p>Please note: Blood pressure fluctuates continually so successive measurements will show some variability.</p> |
| Blood pressure measured differs from those values measured by the doctor. | <ol style="list-style-type: none"> 1. Record the daily development of the values and consult your doctor. <p>Please note: Individuals visiting their doctor frequently experience anxiety which can result in a higher reading at the doctor than obtained at home under resting conditions.</p> |

8. CARE AND MAINTENANCE, RECALIBRATION

- Do not expose the device to either extreme temperatures, humidity, dust, or direct sunlight.
- The cuff contains a sensitive air-tight bubble. Handle this carefully and avoid all types of straining through twisting or buckling.
- Clean the device with a soft, dry cloth. Do not use petrol, thinners, or similar solvent. Spots on the cuff can be removed carefully with damp cloth and soapsuds. The cuff must not be washed!
- Do not drop the instrument or treat it roughly in any way. Avoid strong vibrations.
- Never open the device! Otherwise, the manufacturer calibration becomes invalid!

9. BATTERY LIFE

1000 times measurement with 4- size "AAA" alkaline Batteries

10. SAFETY, CARE, AND DISPOSAL

△Safety and protection

- This instrument maybe used only for the purpose described in this booklet. The manufacturer cannot be held liable for the damage caused by incorrect application.
- This instrument comprises sensitive components and must be treated with caution. Observe the storage and operating condition described in the "Technical specifications" section!



- Protect it from water and moisture, extreme temperatures, impact and dropping, contamination and dust, direct sunlight, heat and cold.
- The cuffs are sensitive and must be handled with care.
- Only pump up the cuff once fitted.
- Do not use the instrument close to strong electromagnetic fields such as mobile telephones or radio installations.
- Do not use the instrument if you think it is damaged or notice anything unusual.
- If the instrument is not going to be used for a prolonged period, the batteries should be removed.
-  Read the additional safety instructions in the individual sections of this booklet. Ensure that children do not use the instrument unsupervised: some parts are small enough to be swallowed.
- Must use the recognized accessories, detachable parts, and materials, if the use of other parts or materials can degrade minimum safety.
- A warning to remove primary batteries if the instruments is not likely to be used for some time.

Instrument care

Clean the instrument only with a soft, dry cloth.



Disposal

Batteries and electronic instruments must be disposed of in accordance with the locally applicable regulations, not with domestic's waste.

11. REFERENCE TO STANDARDS

Device standard: Device corresponds to the requirements of the European standard for non-invasive blood pressure monitor

| |
|--|
| IEC60601-1-6:2010+A1:2013/ EN60601-1-6:2010+A1:2015 |
| IEC60601-1:2005+A1:2012/EN60601-1:2006+A11:2011+A1:2013+A12:2014 |
| IEC60601-1-2:2014/ EN60601-1-2:2015 |
| IEC/EN60601-1-11:2015 |
| IEC80601-2-30:2009+A1:2013/EN80601-2-30:2010+A1:2015 |

The stipulations of the EU-Guidelines 93/42/EEC for Medical Products Class IIa have been fulfilled.

12. TECHNICAL SPECIFICATIONS

| | |
|------------------------|--|
| Measurement Procedure: | Oscillometric, corresponding to Korotkoff method: Phase I: systolic , Phase V : diastolic |
| Display: | Digital display |
| Measuring range: | SYS/DIA: 30 to 280 mmHg (in 1 mmHg increment) Pulse: 40 to 199 beat/minute |
| Static accuracy: | SYS/DIA: ± 3 mmHg / Pulse: $\pm 5\%$ of reading |
| Measuring resolution: | 1mmHg |
| Inflation: | Automatic inflation by internal pump |



| | |
|--------------------------------------|---|
| Memory function: | 2 x 120 memories for 2 users (SYS, DIA, Pulse) |
| Decompression: | Constant exhaust valve system |
| Power source: | 4- size "AAA" alkaline batteries |
| Operation temperature: | 5-40°C/41-104°F |
| Operation humidity: | 15%-85%RH maximum |
| Storage temperature: | -20~+55°C/-4~+131°F |
| Storage humidity: | 10%-95%RH maximum |
| Dimensions: | 135 x 90 x 41 ±1.0 mm |
| Weight: | 372 g±5g (including batteries and cuff) |
| Cuff pressure display range: | 0~290mmHg/0~38.7KPa |
| Electrical shock protection: | Internal power unit |
| Safety classifications: | Type BF equipment |
| Mode of operation: | Continuous operation |
| Protection against ingress of water: | IP22 |
| Accessories: | S- size Cuff, 4 "AAA" batteries, instruction manual |

13. MANUFACTURER'S DECLARATION

The Paediatric BP Monitor-111 is intended for use in the electromagnetic environment specified below. The customer or the user of the Paediatric BP Monitor-111 should assure that it is used in such an environment.

Electromagnetic Emissions: (IEC60601-1-2)

| Emission Test | Compliance | Electromagnetic Environment |
|---|----------------|--|
| RF emission CISPR 11 | Group 1 | The Paediatric BP Monitor-111 uses RF energy only for internal functions. Therefore, this RF emission is extremely weak and there is little chance of it creating any kind of interference whatsoever with nearby electronic equipment. |
| RF emissions CISPR 11 | Class B | The Paediatric BP Monitor-111 is suitable for use in all establishments, including domestic establishments and those directly connected to the public low voltage power supply network that supplies buildings used for domestic purposes. |
| Harmonic emissions IEC 61000-3-2 | Not applicable | |
| Voltage fluctuations/ flicker IEC 61000-3-3 | Not applicable | |



| Electromagnetic Immunity: (IEC60601-1-2) | | | |
|--|--|----------------------------|---|
| Immunity test | IEC60601-1-2 test level | Compliance level | Electromagnetic environment -guidance |
| Electrostatic discharge (ESD) IEC 61000-4-2 | ±6 kV contact ±8 kV air | ±6 kV contact ±8 kV air | Floors should be wood, concrete, or ceramic tile. If floors are covered with synthetic material, the relative humidity should be at least 30 %. |
| Electric fast transient/ burst IEC 61000-4-4 | ±2 kV for power supply lines ±1 kV for input/output lines | Not applicable | Mains power quality should be that of a typical commercial or hospital environment. |
| Surge IEC 61000-4-5 | ±1 kV differential mode ±2 kV common mode | Not applicable | Mains power quality should be that of a typical commercial or hospital environment. |

| | | | |
|--|---|----------------|---|
| Voltage dips, short interruptions, and voltage variations on power supply input lines IEC 61000-4-11 | <5 % UTØ95% dip in UT. Ø for 0.5 cycle 40 % UTØ60% dip in UT Øfor 5 cycles 70 % UT(30% dip in UT) for 25 cycles <5 % UTØ95% dip in UTØfor 5 sec. | Not applicable | Mains power quality should be that of a typical commercial or hospital environment. If the user of the upper arm style requires continued operation during power mains interruptions, it is recommended that Pediatric BP Monitor-111 be powered from an uninterruptible power supply or a battery. |
| Power frequency (50/ 60 Hz) magnetic field IEC 61000-4-8 | 3 A/m | Not applicable | Not applicable |

Note: UT is the a.c. mains voltage prior to application of the test level.



| Immunity test | IEC60601-1-2 test level | IEC60601-1-2 test level | Electromagnetic environment -guidance |
|-------------------------------|---------------------------------------|-------------------------|--|
| Conducted RF IEC 61000-4-6 | 3 Vrms 150 kHz to 80 MHz 80% AM (2Hz) | 3 Vrms | Portable and mobile RF communications equipment should be used no closer to any part of Paediatric BP Monitor-111, including cables, than the recommended separation distance calculated from the equation applicable to the frequency of the transmitter. |
| Radiated RF IEC 61000-4-3 | 3 Vrms 80 MHz to 2.5 GHz 80% AM (2Hz) | 3 V/m | Recommend separation distance 3V d = 1.2×p1/2 80MHz to 800 MHz d = 2.3×p1/2MHz to 2.5 GHz Where Pis the maximum output power rating of the transmitter in watts (W) according to the transmitter manufacturer and d is the recommended separation distance in meters (m). Field strengths from fixed RF transmitters as determined by an electromagnetic site surveya, should be less than the compliance level in each frequency range b . Interference may occur in the vicinity of equipment marked with the following symbol:  |

| |
|--|
| Note1: At 80 MHz and 800 MHz, the higher frequency range applies. Note2: These guidelines may not apply in all situations. Electromagnetic propagation is affected by absorption and reflection from structures, objects, and people. |
| a) Field strengths from fixed transmitters, such as base stations for radio (cellular/cordless) telephones and land mobile radios, amateur radio, AM and FM radio broadcast and TV broadcast cannot be predicted theoretically with accuracy. To assess the electromagnetic environment due to fixed RF transmitters, an electromagnetic site survey should be considered. If the measured field strength in the location in which the Pediatric BP Monitor-111 is used exceeds the applicable RF compliance level above, the Pediatric BP Monitor-111 should be observed to verify normal operation. If abnormal performance is observed, additional measures may be necessary, such as reorienting or relocating the Pediatric BP Monitor-111. |
| b) Over the frequency range 150 kHz to 80MHz, field strengths should be less than 3 V/m. |
| Recommended Separation Distances: |
| Recommended separation distance between portable and mobile RF communications equipment and the Paediatric BP Monitor-111 |
| The Paediatric BP Monitor-111 is intended for use in an electromagnetic environment in which radiated RF disturbances are controlled. The customer or the user of the Paediatric BP Monitor-111 can help prevent electromagnetic interference by maintaining a minimum distance between portable and mobile RF communications equipment (transmitters) and the Pediatric BP Monitor-111 as recommended below, according to the maximum output power of the communications equipment. |



| Rated maximum output power of transmitter (W) | 150 kHz to 80 MHz | 80 MHz to 800 MHz | Separation distance according to frequency of transmitter m |
|---|--------------------------|--------------------------|---|
| | $d = 1.2 \times p^{1/2}$ | $d = 1.2 \times p^{1/2}$ | 800 MHz to 2.5 GHz $d = 2.3 \times p^{1/2}$ |
| 0.01 | 0.12 | 0.12 | 0.23 |
| 0.1 | 0.38 | 0.38 | 0.73 |
| 1 | 1.2 | 1.2 | 2.3 |
| 10 | 3.8 | 3.8 | 7.3 |
| 100 | 12 | 12 | 23 |

For transmitters rated at a maximum output power not listed above, the recommended separation distance d in meters (m) can be determined using the equation applicable to the frequency of the transmitter, where P is the maximum output power rating of the transmitter in watts (W) according to the transmitter manufacturer.

Note1: At 80MHz and 800MHz, the separation distance for the higher frequency range applies

Note2: These guidelines may not apply in all situations. Electromagnetic propagation is affected by absorption and reflection from structures, objects and people.

CUSTOMER SUPPORT

CONTACT ADDRESS

USA

Nureca INC.USA
276 5th Avenue, Suite 704-397,
New York (NY) - 10001, USA

INDIA

Corporate Office (Mumbai)
Nureca Limited
128 Gala Number Udyog Bhavan,
1st Floor Sonawala Lane, Goregaon East
Mumbai City Maharashtra 400063

Contact us

India: +91-7527013265 / +91-9356658436

Website: www.drtrust.in

Corp Website: www.nureca.com

Email: customercare@nureca.com

Connect with us on social networks

Facebook: @drtrust

Instagram: @drtrustisin

Youtube: NurecaUsa



Scan to View
Product Demo Video
www.drtrustusa.com/111

COPYRIGHT©2021 NURECA LTD ALL RIGHTS RESERVED