

Generation 3™

by **KIRBY**®

CONGRATULATIONS

Congratulations.

You are now the proud owner of a world-class Generation 3™ by Kirby®.

The Generation 3 is the result of years of extensive research. Dedicated Kirby engineers employed the latest state-of-the-art technology and the highest quality materials to design and build this, the latest generation Kirby. All of which means you own one of the most complete, advanced and easy-to-use home maintenance systems available today.

To fully enjoy the benefits of your new Generation 3, you will want to know the correct way to use its many features. This Owner's Manual provides information you need to obtain the utmost in cleaning convenience. It will also help you provide the best care for your system. So please become familiar with the Generation 3 by reading the entire Owner's Manual.

In the event you require service or information about your Kirby Generation 3, attachments, accessories or warranty, your authorized independent Kirby Distributor will be happy to provide assistance. Check your telephone Yellow Pages under the heading "Vacuum cleaners" for the authorized Kirby Distributor near you.

Look for the Registered Kirby Trademark.

IMPORTANT SAFETY INSTRUCTIONS

The Kirby® Generation 3™ Models G3D and G3C are Listed and Certified by Underwriters Laboratories Inc., and Canadian Standards Association, respectively, as double insulated appliances. The Model 5589 Carpet Shampoo System, Model 1589 Floor Care Kit, Model 4689 Zippbrush and Model 4589 Turbo Accessory Kit are also Listed and Certified as Optional Accessories for use with these models of Generation 3.

READ THE MANUAL AND ALL INSTRUCTIONS BEFORE USING THE KIRBY GENERATION 3 WHEN USING AN ELECTRICAL APPLIANCE, BASIC PRECAUTIONS SHOULD ALWAYS BE FOLLOWED INCLUDING THESE:

WARNING - To reduce the risk of fire, electric shock or injury:

- Do not leave appliance unattended or running when plugged in. Unplug from outlet when not in use and before servicing.
- Do not use outdoors. Use only on dry surfaces or with the Kirby Carpet Shampoo System.
- Do not allow to be used as a toy. Close attention is necessary when used by or near children.
- Use only as described in this manual. Use only manufacturer's recommended attachments.
- Do not use with damaged cord or plug. If appliance is not working as it should, has been dropped, damaged, left outdoors or dropped into water, return it to a service center.
- Do not pull or carry by cord, use cord as a handle, close door on cord, or pull cord around sharp edges or corners. Do not run appliance over cord. Keep cord away from heated surfaces.
- Do not unplug by pulling on cord. To unplug, grasp the plug, not the cord.
- Do not handle plug or appliance with wet hands.
- Do not put any object into openings. Do not use with any opening blocked; keep openings free of dust, lint, hair and anything that may reduce air flow.
- Keep hair, loose clothing, fingers and all parts of body away from openings and moving parts.
- Do not pick up anything that is burning or smoking, such as cigarettes, matches or hot ashes.
- Do not use without dustbag and/or filters in place.
- Turn Kirby OFF before unplugging the cord.
- Use extra care when cleaning on stairs.
- Do not use to pick up flammable or combustible liquids such as gasoline, or use in confined areas where flammable or combustible vapors are present.
- When using the Carpet Shampoo System, do not use flammable or combustible liquids to clean carpet or floor.
- Unplug the cord from the wall outlet and let the motor come to a complete stop before changing accessory kits.
- This appliance is provided with Double Insulation. It should be serviced by a qualified Kirby Service Person using genuine Kirby parts in order to maintain safety and to protect your warranty. See page 57.
- Keep all Kirby chemicals out of the reach of children. These chemicals may cause irritation or discomfort if swallowed or placed in the eyes.
- Do not use solvent or oil base paints or any other flammable or combustible fluid in the Portable Sprayer.
- Do not use pesticides or chemical products in the Portable Sprayer that may affect or damage the human respiratory system, eyes or skin.

**SAVE THESE INSTRUCTIONS
FOR HOUSEHOLD USE ONLY**

TABLE OF CONTENTS

| | |
|---|-----------|
| About this Manual | 4 |
| Part 1 — Getting Started | 5 |
| Moving Your Generation 3™/Handle Tilt Latch | 6 |
| Toe-Touch Control™ | 7 |
| TechDrive™ Power Assist | 8 |
| Installing/Changing Disposable Filter Bags | 9 |
| Bag Support Strap/Mini Em-Tor | 10 |
| The Belt Lifter | 11 |
| Brush Roll Indicator Light/Power Nozzle Height | 12 |
| Part 2 — Upright & Portable Cleaner | 13 |
| The Upright Cleaner | 14 |
| The Upright as a Straight Suction Cleaner | 16 |
| The Portable Cleaner | 17 |
| Part 3 — Canister Cleaner & Attachments | 19 |
| Installing the Attachment Hose | 20 |
| Extension Tubes/Surface Nozzle/Duster Brush | 22 |
| Upholstery Nozzle/Crevice Tool/ Wall & Ceiling Brush | 23 |
| Massage Cup/Suction Control Grip | 24 |
| Using Your Generation 3 as a Blower | 25 |
| The Portable Sprayer | 28 |
| The Portable Shampooer | 31 |
| Part 4 — Optional Accessories | 33 |
| The Carpet Shampoo System | 34 |
| The Floor Care Kit - Floor Polisher | 42 |
| The Floor Care Kit - Carpet Fluffer | 46 |
| The Turbo Accessory Kit™ | 47 |
| The Zippbrush™ | 50 |
| Part 5 — Operating/Maintenance Tips | 51 |
| Changing the Power Nozzle Belt | 52 |
| Adjusting the Brush Roll for Optimum Performance | 55 |
| Questions and Answers | 57 |
| Other Fine Kirby Cleaning Products | 58 |
| Index | 60 |

Expanded Illustration of Generation 3 and Filter System - Inside back cover.

ABOUT THIS MANUAL

Using this Owner's Manual

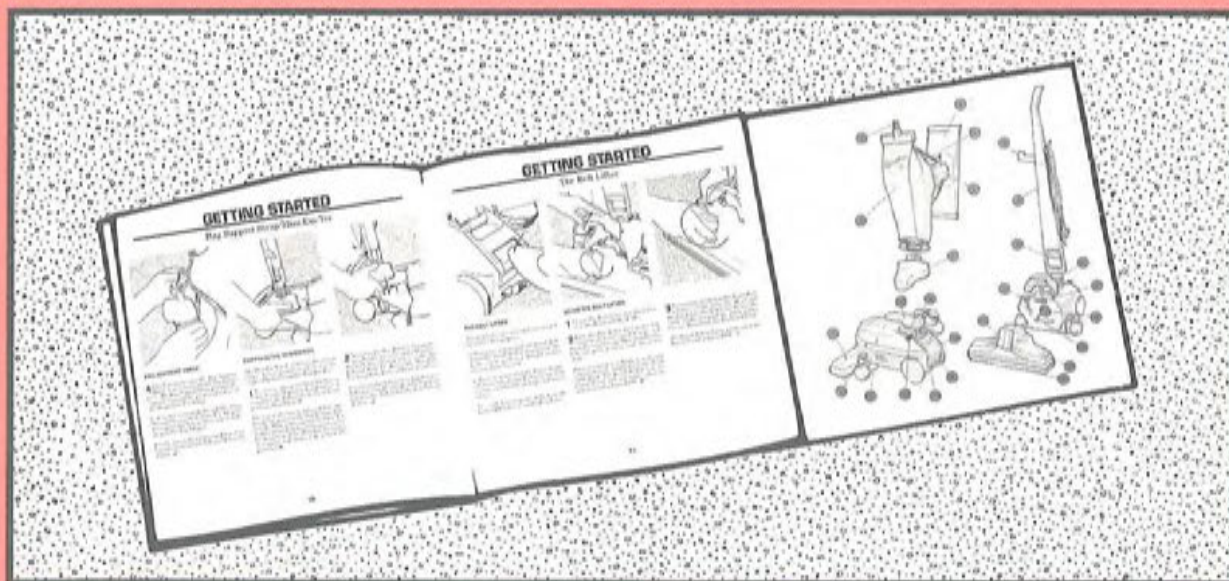

This Owner's Manual was designed to be easy to read and follow. It has been organized in sections based on the various ways you may use your new Generation 3™. Within each section, simple step-by-step illustrations will help you easily visualize the steps required to properly operate your new Kirby® and its many attachments and optional accessories.

Please note: The rear cover of this Owner's Manual includes a fold-out illustration that points out the location of various parts of your new Generation 3. Simply fold this flap out and refer to the illustrations and corresponding (#) as you read this manual.

In addition to the Table of Contents on Page 3, you will also find an Index on Page 60 that will refer you to the information you require.

We at Kirby sincerely hope this Owner's Manual will help you obtain years of satisfactory performance from your world-class Generation 3.

GETTING STARTED

P A R T O N E

This section outlines general information you will need as you begin using your new Generation 3™. It includes information on:

- Moving and carrying your Generation 3.
- Using the Handle Tilt Latch.
- The Toe-Touch Control.
- Using TechDrive™ Power Assist.
- Installing/Changing disposable filter bags.
- Emptying the Mini Em-Tor™.
- Understanding the Belt Lifter.
- The Brush Roll Indicator Light.
- Proper Power Nozzle height.

Please read this section (as well as all other sections) carefully before using your new Generation 3.

GETTING STARTED

Moving/Carrying Your Generation 3 & Handle Tilt Latch

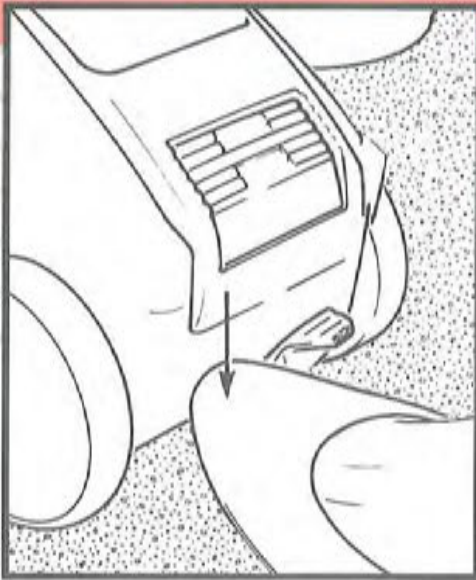

MOVING YOUR GENERATION 3

Your Generation 3 is equipped with TechDrive Power Assist. In order to push your Generation 3 with the motor OFF, TechDrive Pedal (11) must be turned OFF (disengaged).

Turn TechDrive OFF by pushing down on the white "N" SIDE (marked "N" for Neutral) of the TechDrive Power Assist N/D Pedal. (See Page 8 for additional information.)

CARRYING YOUR GENERATION 3

Note: The Carrying Grip (18) is designed for convenience in carrying your Generation 3.

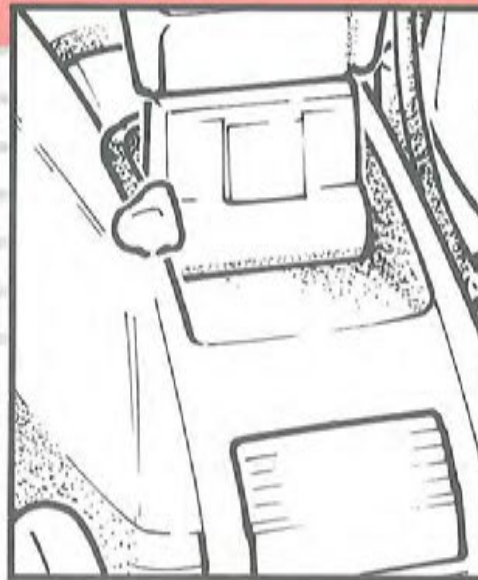

HANDLE TILT LATCH

The Handle Tilt Latch (10) serves two purposes:

1) To allow you to lift the front of the Kirby over door thresholds or throw rugs. To do so, pull the Handle Tilt Latch back. By doing this, the handle will only lower part way. This allows you to push down on the locked handle and lift the front of the Kirby.

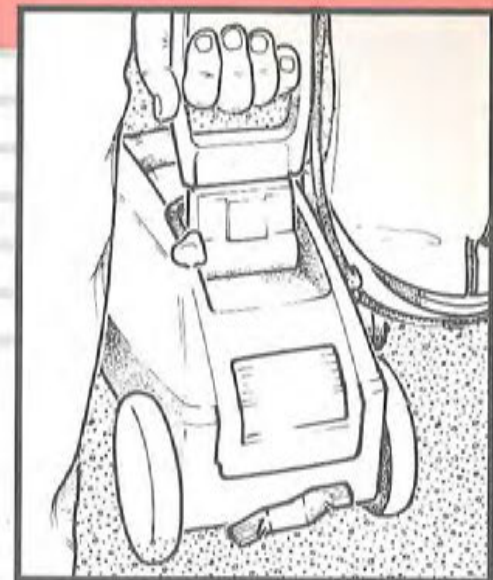

2) To allow you to store your Kirby in a vertical position.

To do this, lower the handle to a horizontal position near the floor. While pushing the handle down, pull the Handle Tilt Latch (10) back toward the rear of the Kirby. You can now stand the Kirby up onto its bumper and lean it against a wall for storage.

This horizontal position may also be useful in carrying the Kirby. To lift the Kirby, use the Carrying Grip (18).

CAUTION:

Never unlock the Handle Tilt Latch without holding on to the handle. The handle is spring-loaded and could fly up when unlatched.

GETTING STARTED

Toe-Touch Control

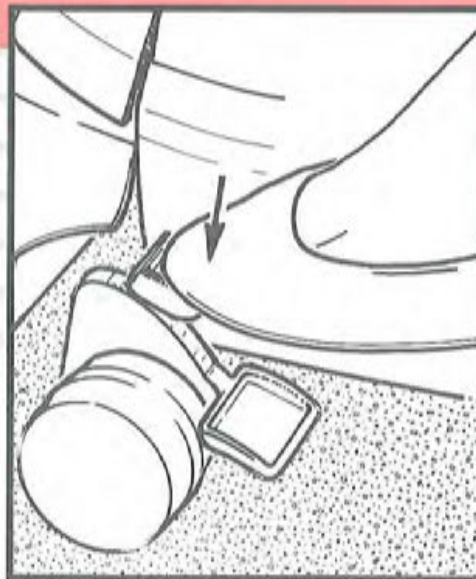
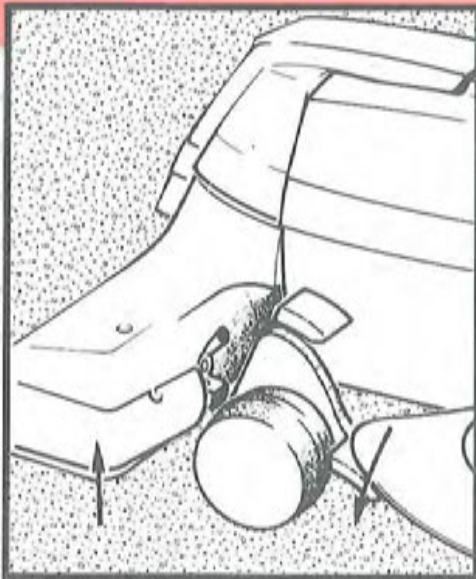

THE TOE-TOUCH CONTROL

The Toe-Touch Control (8,9), located over the front wheel, raises and lowers the front of your Kirby.

Step down on the bottom Toe-Touch Control Pedal (9) to raise the front (see page 14).

Then, each time you press on the Toe-Touch Control Upper Pedal (8), you will lower the front one notch.

The number of bars showing above the Toe-Touch Control provide an indication of height.

GETTING STARTED

TechDrive Power Assist

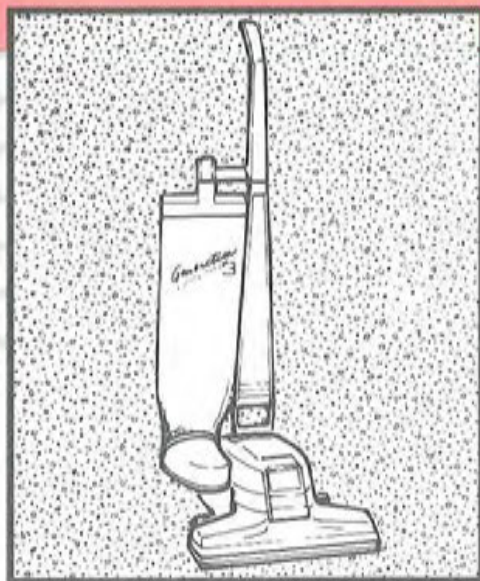

TechDrive

Your new Generation 3 is equipped with TechDrive Power Assist. This innovative power assist feature eliminates most of the effort required to move your Kirby back and forth.

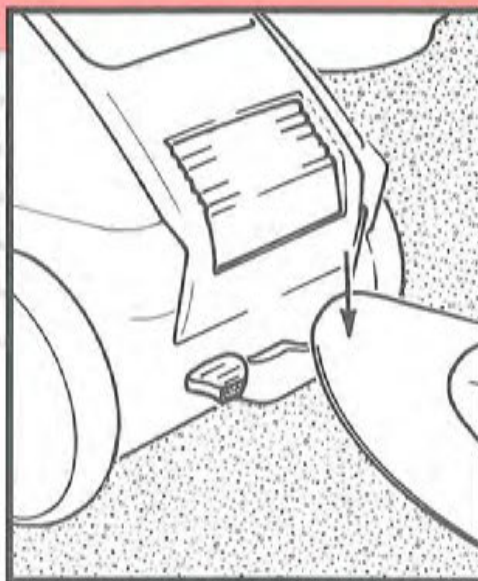

TURNING TechDrive ON (Drive)

To engage TechDrive and put the Kirby in the Power Assist mode, push down the green "D" SIDE (marked "D" for Drive) of the TechDrive N/D Pedal (12) located just below the power switch.

You may use your Generation 3 without TechDrive Power Assist if desired. Simply put TechDrive in Neutral (see next paragraph).

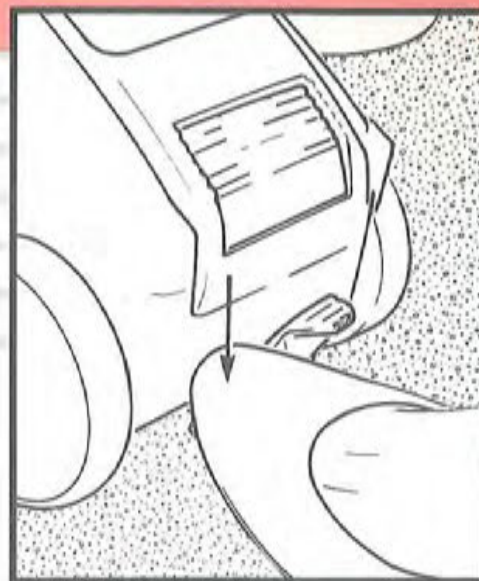

TURNING TechDrive OFF (Neutral)

To move your Kirby with the motor OFF, or to vacuum without Power Assist, TechDrive must be put in Neutral.

To place TechDrive in Neutral, push down the white "N" SIDE (marked "N" for Neutral) of the TechDrive Power Assist N/D Pedal (11).

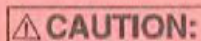

CAUTION: To avoid possible damage to soft tiles or marking of waxed and finished non-carpeted floors, disengage the TechDrive

GETTING STARTED

Installing/Changing Disposable Filter Bags

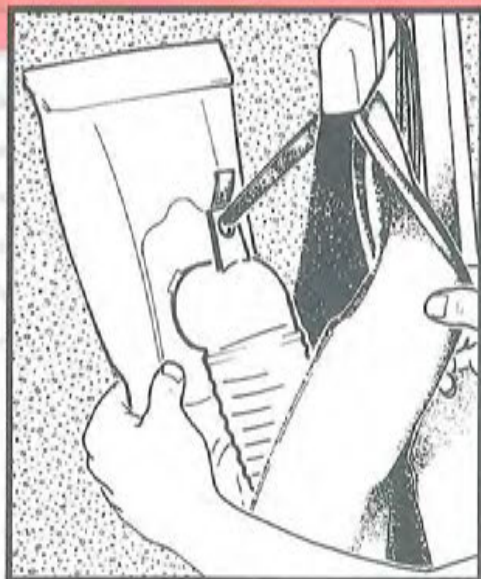

INSTALLING/CHANGING DISPOSABLE FILTER BAGS

A Disposable Filter Bag must be installed before you begin vacuuming.

1 To install a Disposable Filter Bag, unzip the Cloth Outer Bag (1) and pull out the Disposable Filter Bag along with the Top Adapter (5). ➤



2 When necessary, remove the used Disposable Filter Bag.

NOTE: Always replace the Disposable Filter Bag when dirt reaches the "FULL" line on the bag. Failure to do so will affect performance.

Hold the Top Adapter (5) steady while you turn the Disposable Filter Bag's cardboard plate to the left (counter-clockwise). When the lock tabs on the Top Adapter align with the slots in the cardboard plate, gently pull the bag off. ➤



3 To install a new filter bag, align the lock tabs on the Top Adapter with the slots in the cardboard plate on the Disposable Filter Bag. Then push the adapter into bag opening. Rotate the adapter to the right (clockwise) to secure the filter bag. ➤

⚠ CAUTION: Before changing the Disposable Filter Bag, unplug the power cord from the wall outlet and be sure that the motor and fan have stopped.

GETTING STARTED

Bag Support Strap/Mini Em-Tor



BAG SUPPORT STRAP

4 Check to make sure the Bag Support Strap (4) is connected to the Top Adapter (5). The Bag Support Strap provides the support required for proper operation of the Disposable Filter Bag.

If it is not connected, thread the strap through the small hole of the Top Adapter. Then place the hole in the strap over the stud on the Top Adapter.

Finally, insert the adapter and new filter bag into the Outer Cloth Bag and close the zipper. □

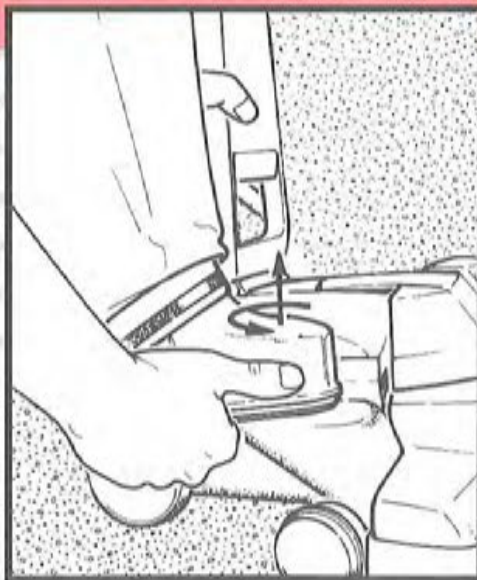

EMPTYING THE MINI EM-TOR

The Mini Em-Tor (6) is designed to collect large, heavy particles which can be emptied by removing the Mini Em-Tor.

1 To remove, grasp the Mini Em-Tor in the handhold provided and rotate it away from the body of the Kirby as far as it will go, then lift it off.

The top of the bag is released from the handle by pressing the Bag Release Button (2). After removing the Mini Em-Tor and the entire Bag Assembly, position the front opening of the Mini Em-Tor over a newspaper and shake it to remove the particles. ➤

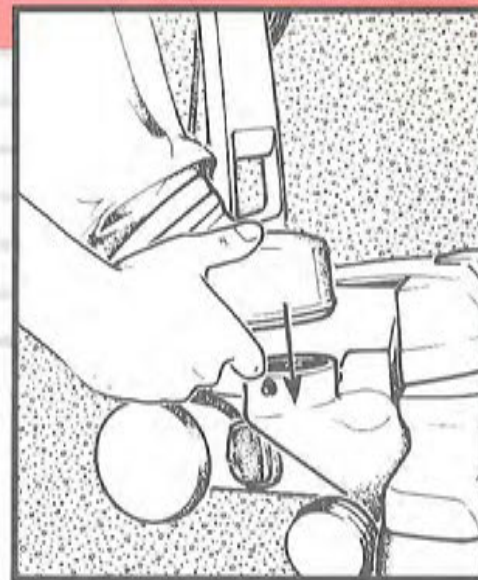

2 To replace the Mini Em-Tor, line up the raised indicator arrow of the Mini Em-Tor with the indicator arrow on the Air Exhaust Port (19). Rotate the Mini Em-Tor toward the Kirby and lock it in place.

Finally, re-attach the entire Bag Assembly by inserting the tab (2) at the top of the bag into the Slot under the Bag Release Button. □

GETTING STARTED

The Belt Lifter

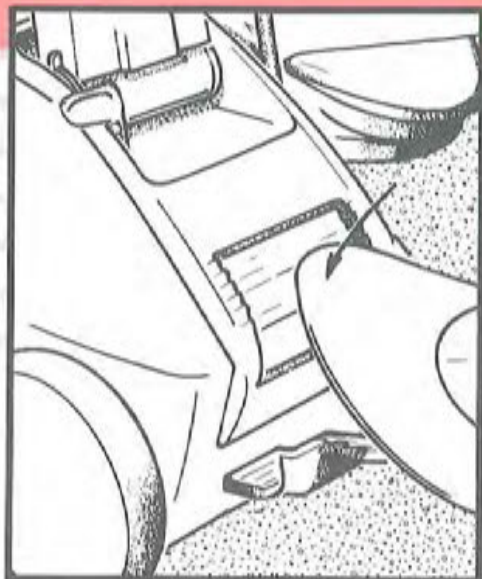

THE BELT LIFTER

The Belt Lifter (20) on your Generation 3 is used for two purposes:

1) To engage or disengage the Brush Roll. When the Brush Roll is disengaged, the Kirby can be used as a straight suction cleaner (Page 16), and ;

2) To allow removal of the Power Nozzle when converting your Kirby for use with various attachments and optional accessories.

To avoid damaging the belt, turn the Kirby OFF before using the Belt Lifter.

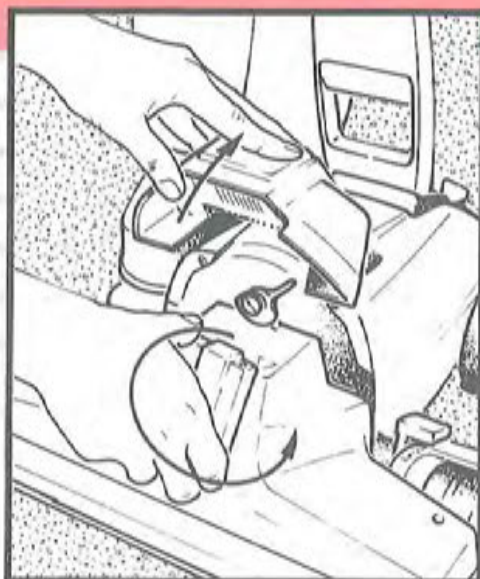

USING THE BELT LIFTER

1 To use the Belt Lifter you must first raise the Headlight Hood (21).

2 Turn the Belt Lifter fully to the left (counter-clockwise) until it stops and the red arrows line up. This stretches the belt and pulls it away from the motor shaft.

If you are using your Kirby as a straight suction cleaner, simply lower the Headlight Hood. The Brush Roll is now disengaged and will not rotate when the power switch is turned ON. ➤

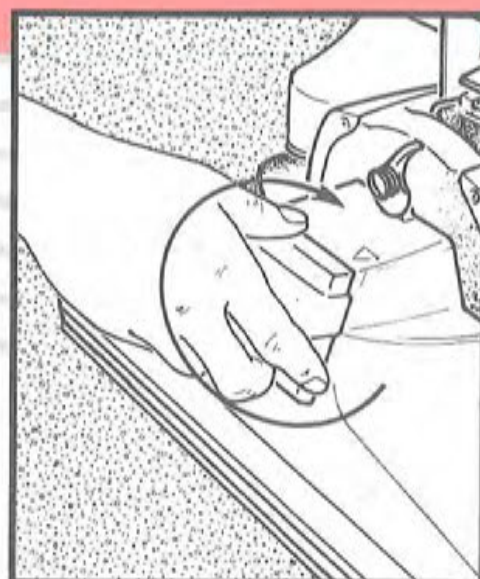

3 To reengage the Belt so the Brush Roll rotates, simply raise the Headlight Hood and turn the Belt Lifter fully to the right (clockwise) until the green arrows line up. Then lower the Headlight Hood.

The Brush Roll will now rotate when the Power Switch is turned ON. □

GETTING STARTED

The Brush Roll Indicator Light/Power Nozzle Height

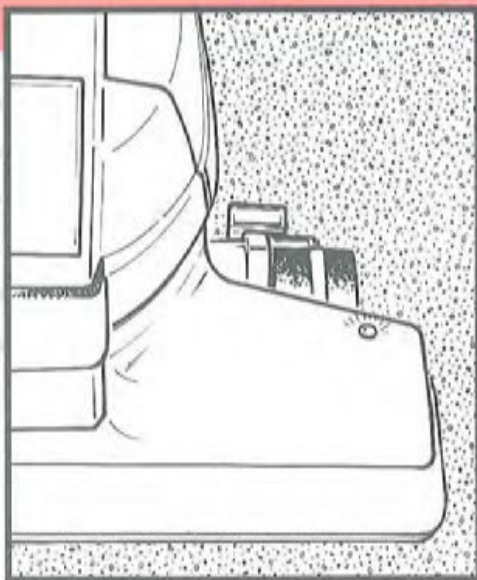

BRUSH ROLL INDICATOR LIGHT

Your Kirby is equipped with a Brush Roll Indicator Light (7), located on the top left side of the Power Nozzle. The purpose of this light is to show you visually if the Brush Roll is rotating properly.

If the Brush Roll Indicator Light continuously flickers or does not come on when using the Power Nozzle, this indicates the Brush Roll Belt is not working properly. Either the Belt is not engaged or may need to be replaced.

For discussion of the Belt Lifter, see Page 11. To replace the Brush Roll Belt, see Page 52.

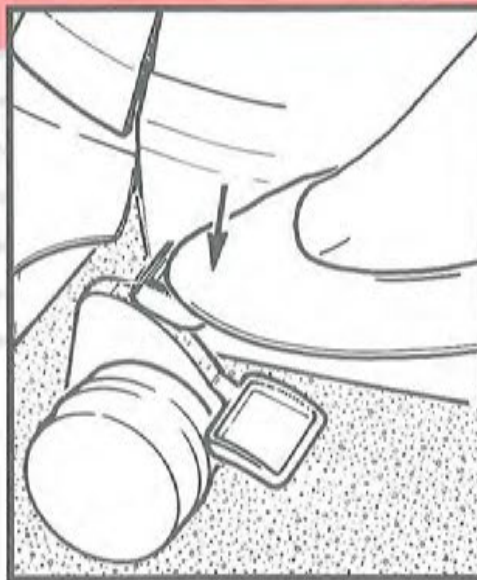

PROPER POWER NOZZLE HEIGHT

When using the Power Nozzle, it is important to adjust the height properly. This will result in the best possible cleaning.

The nozzle should be lowered with the motor running until you hear the brush contact the carpet. While it may seem that lowering the nozzle farther would increase cleaning, it actually does not.

The amount of air-flow into the Kirby determines the amount of cleaning. While lower positions may increase the beating action of the Brush Roll, they will also restrict air movement and reduce cleaning effectiveness. (See "The Upright Cleaner" on Page 14 for further information.)

UPRIGHT & PORTABLE CLEANER

P A R T T W O

Your Kirby® Generation 3™ is an extremely versatile home maintenance system. In this section, we will discuss the following:

- Using your Generation 3 as an Upright Cleaner.
- Using your Upright as a Straight Suction Cleaner.
- Cleaning Hard-Surface Floors.
- Using your Generation 3 as a Portable Cleaner.
- Cleaning mattresses and carpeted stairs.

This section provides the information you need to use your Generation 3 for a wide variety of jobs.

UPRIGHT & PORTABLE CLEANER

The Upright Cleaner

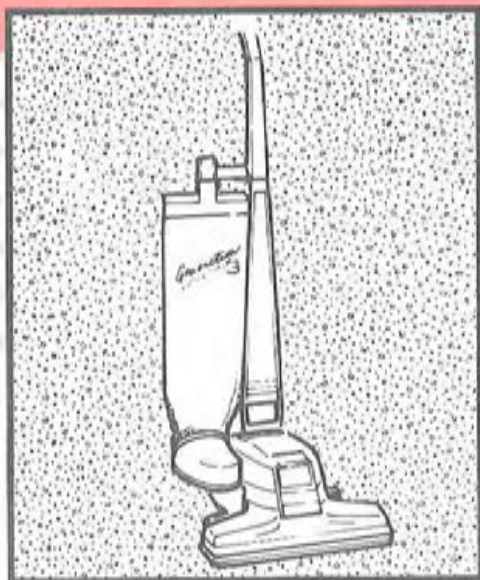

THE UPRIGHT CLEANER

Before you begin vacuuming, it's important to have the Power Nozzle (25) adjusted to the proper height setting. This gives you the most efficient cleaning action. Lowering the Power Nozzle too far prevents proper cleaning and shortens belt life.

The proper height setting can be achieved by doing the following:

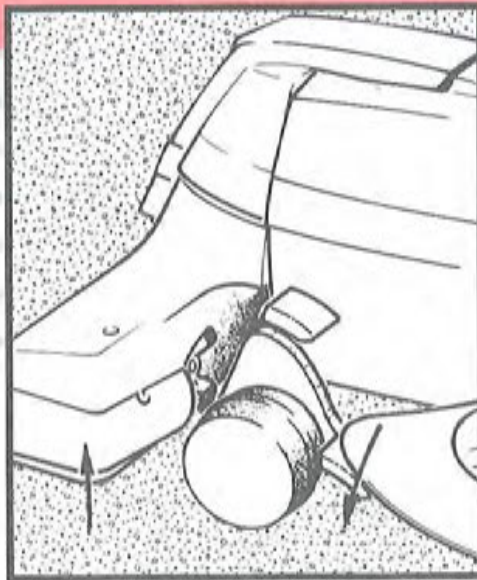

1 Before you turn the Generation 3 ON, raise the Power Nozzle by pushing the Toe-Touch Control bottom pedal (9) all the way down (see Page 7 for additional details). ➤

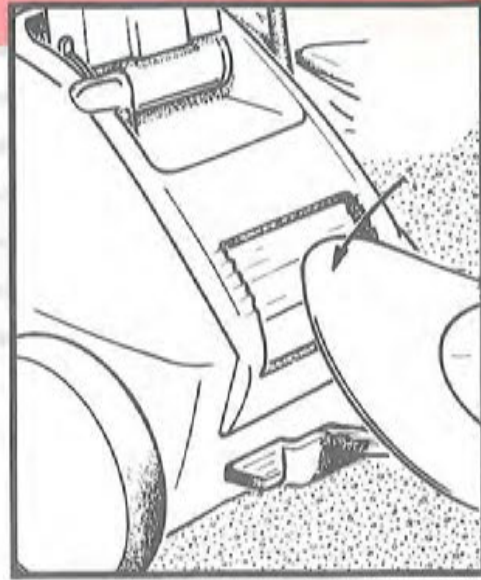

2 Turn the Kirby ON by pressing the Power Switch (13). ➤

UPRIGHT & PORTABLE CLEANER

The Upright Cleaner (continued)

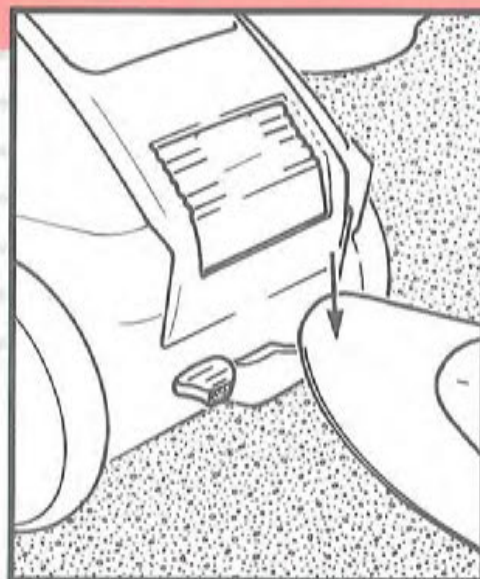
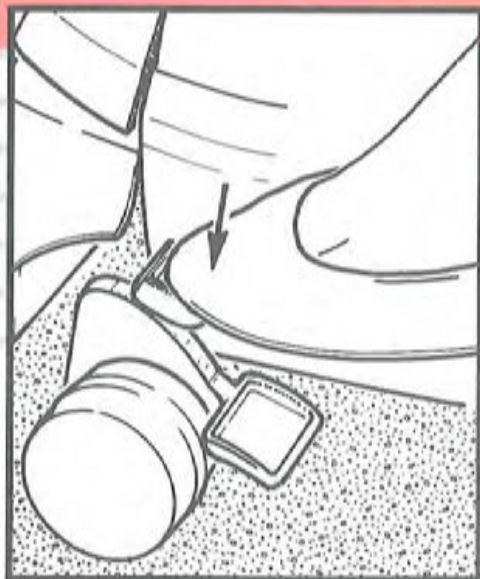

THE UPRIGHT CLEANER (cont)

3 Lower the Power Nozzle by stepping on the Toe-Touch Control upper pedal (8) until you hear the brush contact the carpet.

Any position lower than this may restrict proper air flow and reduce cleaning effectiveness. ➤

4 If power assist is desired, engage Tech-Drive by pushing down the green "D" SIDE (marked "D" for Drive) of the Tech-Drive Power Assist N/D Pedal (12) located just below the Power Switch.

NOTE: If you desire more fluffing of the carpet, adjust the Brush Roll to the next position (II or III). (This is NOT done by lowering the Toe-Touch Control.) To adjust the Brush Roll, see Page 55. □

UPRIGHT & PORTABLE CLEANER

Straight Suction Upright Cleaner

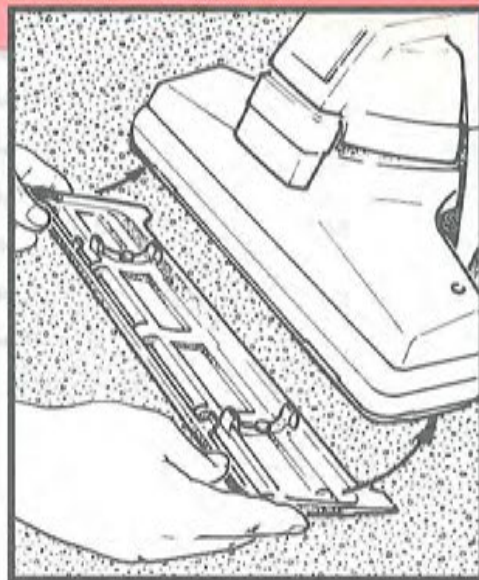
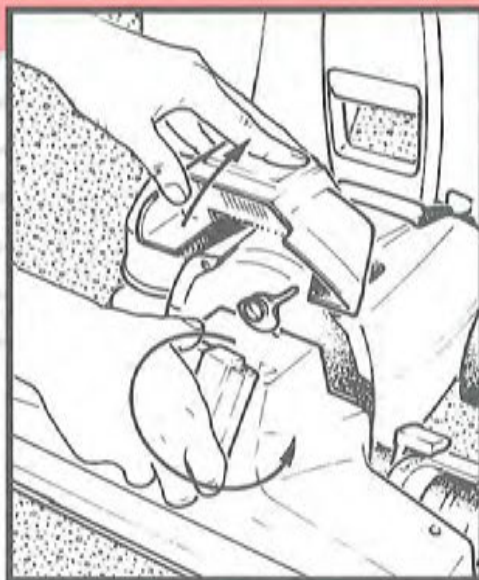

STRAIGHT SUCTION CLEANER

Straight Suction Cleaning allows you to vacuum delicate carpets without use of the Brush Roll.

NOTE: When using Straight Suction Cleaning without the Hard Floor Pad, either on carpets or bare floors, lower the nozzle as close as possible to the floor without scraping it.

1 With the Kirby turned OFF, raise the Headlight Hood (21). ➤

2 Turn the Belt Lifter (20) all the way to the left (counter-clockwise) until the red arrows line up (see Page 11).

Then lower the Headlight Hood.

The Brush Roll is now disengaged and your Kirby will operate as a Straight Suction Cleaner. □

THE HARD FLOOR PAD

By attaching the optional Hard Floor Pad to your Kirby, you may dust bare floors. While the Kirby is turned OFF, raise the Power Nozzle as far as it will go by pressing the bottom Toe-Touch Control Pedal (9). Attach the Hard Floor Pad onto the nozzle opening using the spring clips on the plate. Then lower the Power Nozzle by pressing the top Toe-Touch Control Pedal (8) one notch at a time until the bristles touch the floor.

Note: The Hard Floor Pad should only be used when the Kirby is in the Straight Suction Cleaner mode. When using the Hard Floor Pad, lower the nozzle until the bristles touch the bare floor.

⚠ CAUTION:

Before installing the Hard Floor Pad, unplug the power cord from the wall outlet and be sure the motor and nozzle brush have stopped.

UPRIGHT & PORTABLE CLEANER

The Portable Cleaner

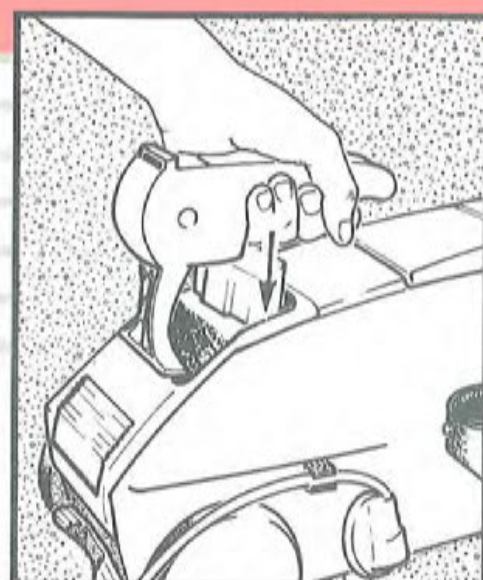
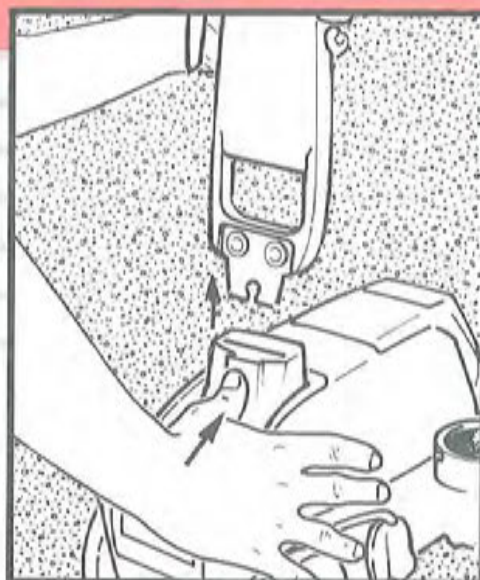
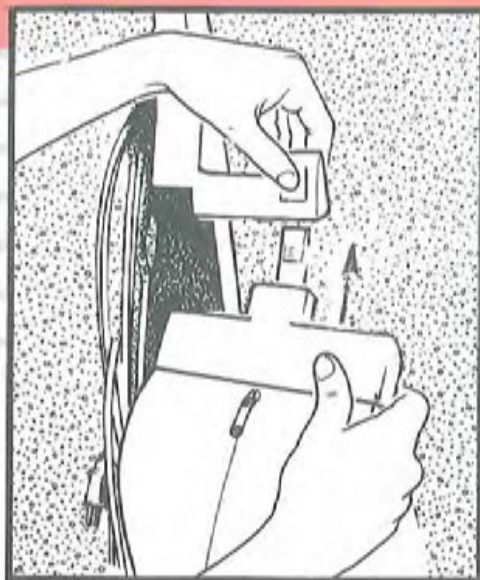

PORTABLE CLEANER SET-UP

Besides a remarkable Upright Cleaner, the Generation 3 can easily be converted into a portable cleaner for mattresses and carpeted stairs..

1 To convert your Generation 3 to a Portable Cleaner, make sure the Kirby is turned OFF.

Then release the Outer Cloth Bag Top from the Bag Support (16) by pressing the Bag Release Button (2) and sliding the bag top off. ➤

2 With the handle in the vertical position, remove the Upright Handle (17) from the Kirby by pushing the Handle Release Button (14), located at the base of the handle, straight up and pulling the handle out of the slot.

3 Insert the Portable Handle (15) into the slot where the Upright Handle was connected. Push the Portable Handle (15) into the slot until it snaps into place. ➤

⚠ WARNING: To reduce risk of injury in the portable mode, place TechDrive in neutral and keep long hair away from the rotating brush in the nozzle.

UPRIGHT & PORTABLE CLEANER

The Portable Cleaner (continued)

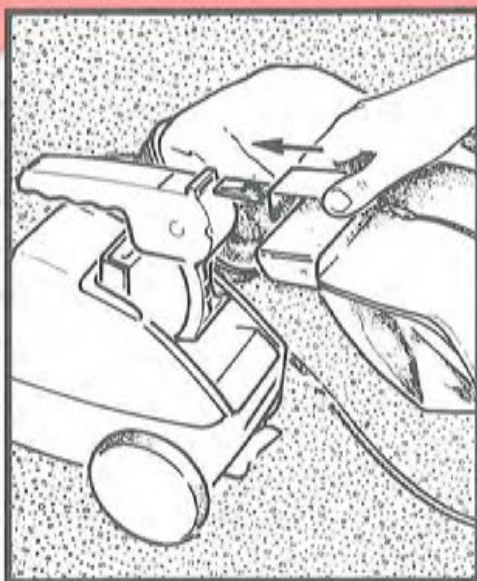

PORTABLE CLEANER SET-UP (cont)

4 Bend the Filter Bag (1) in half and insert the Bag Latch Tab (2) into the slot on the Portable Handle until it snaps into place.

You are now ready for portable power cleaning. □

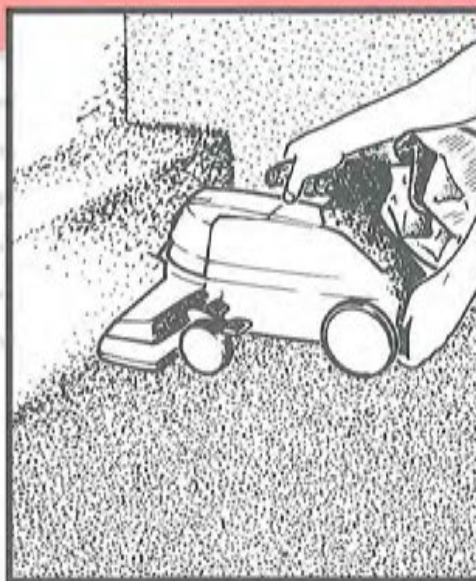

CARPETED STAIRS

Roll the cleaner back and forth so that the Brush Roll sweeps the carpeting and loosens the dirt.

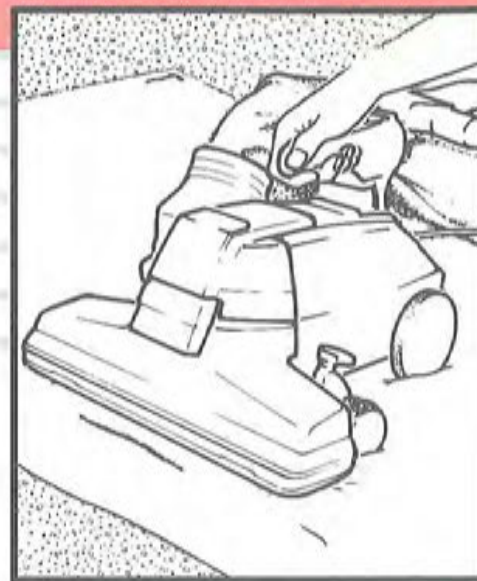

MATTRESS CLEANING

Cleaning soft mattress surfaces is done the same as carpeted surfaces, except that you may want to disengage the Brush Roll. (If your mattress has tufted buttons on the surface, the Brush Roll could pull them loose.)

For straight suction cleaning, raise the Headlight Hood (21) and turn the Belt Lifter (20) all the way to the left (counter-clockwise) until the red arrows line up. This will stop the Brush Roll from turning.

Then lower the Headlight Hood.

CANISTER CLEANER & ATTACHMENTS

P A R T T H R E E

Your Generation 3™ comes with a wide variety of attachments for added versatility. In this section, we will discuss the following:

- Removing the Power Nozzle to convert to a canister cleaner.
- Using Extension Tubes.
- Using the Suction Control Grip.
- Using the Surface Nozzle, Duster Brush, Upholstery Nozzle, Crevice Tool, Wall & Ceiling brush and the Massage Cup.
- Using your Generation 3 as a blower unit.
- Using the Portable Sprayer and the Portable Shampooer™.

This section will add even greater value to your Generation 3 by providing information you need to use attachments for a wide variety of jobs.

CANISTER CLEANER & ATTACHMENTS

Installing the Attachment Hose

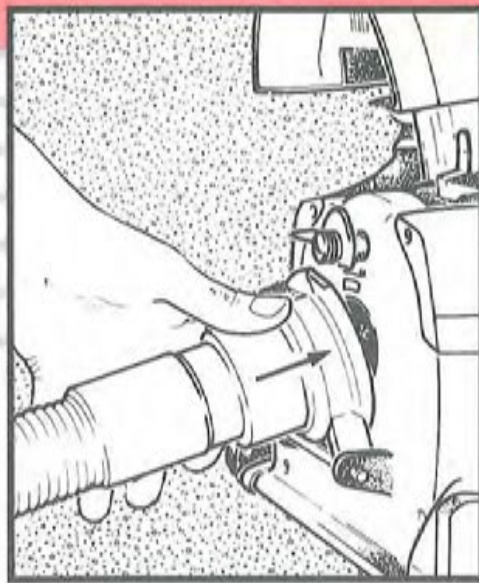
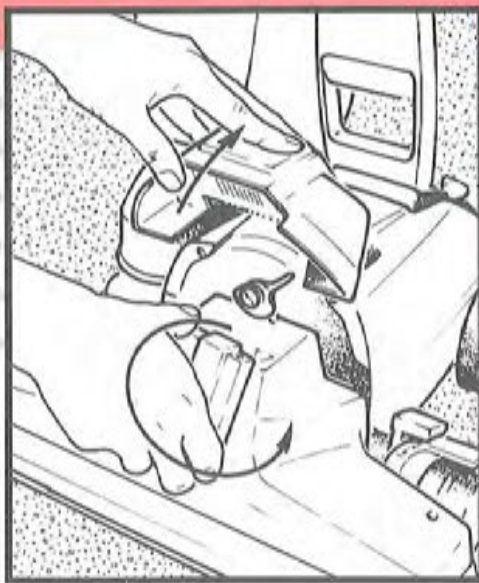
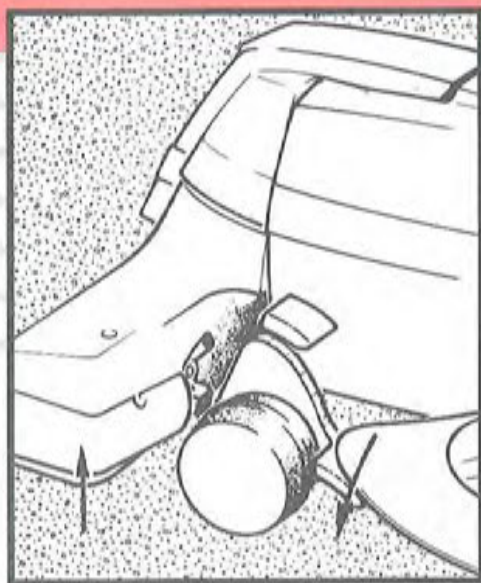

INSTALLING THE ATTACHMENT HOSE

When using different cleaning attachments, the Attachment Hose is connected to the front of the cleaner in place of the Power Nozzle.

NOTE: When connecting the Attachment Hose, you may choose between the Upright Handle or the Portable Handle (see column 3 on Page 17).

1 To install the Attachment Hose, you must first remove the Power Nozzle. To do so, turn the power OFF, place Tech-Drive Power Assist (11) in Neutral (see Page 8), unplug the Kirby from the wall outlet and press the Toe-Touch Control bottom pedal (9) all the way down until nozzle is fully raised. >

2 Raise the Headlight Hood (21) and turn the Belt Lifter (20) all the way to the left (counter-clockwise) until it stops and the red arrows line up.

3 Unlock the Power Nozzle by turning the Accessory Lock (22) all the way to the left (counter-clockwise). The Power Nozzle should tip forward when it is released. Lift the nozzle away from the Kirby and off. >

4 At the connector end of the Attachment Hose you will notice two hook-shaped lugs. Hook the lugs over the ends of the Attaching Bar (24) then push the opening of the hose up against the Kirby. >

CANISTER CLEANER & ATTACHMENTS

Installing the Attachment Hose (continued)

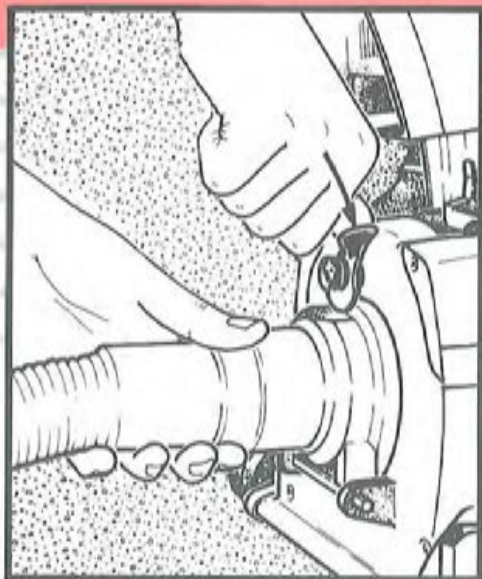

INSTALLING THE ATTACHMENT HOSE (cont)

5 Lock the Attachment Hose Connector in place by turning the Accessory Lock (22) all the way to the right (clockwise). (The Accessory Lock will clamp the Attachment Hose to the Kirby.)

With the Attachment Hose in place, the Kirby will automatically adjust to high speed for hose operation.

NOTE: If the Kirby will not run when the power switch is ON, see Page 57, column 2, item 4. □



INSTALLING ATTACHMENTS ON THE ATTACHMENT HOSE

To attach tools to the hose, push lightly while twisting the smaller end of the hose into the tool.

CANISTER CLEANER & ATTACHMENTS

Using the Attachments

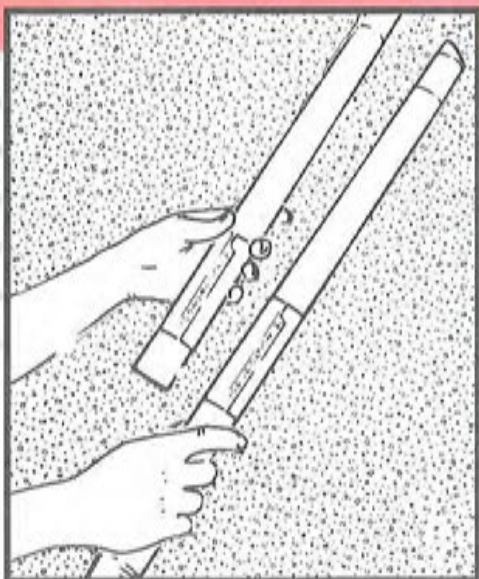

EXTENSION TUBES

One or two Extension Tubes can be attached to the end of the hose to extend your reach and efficiently use various attachments.

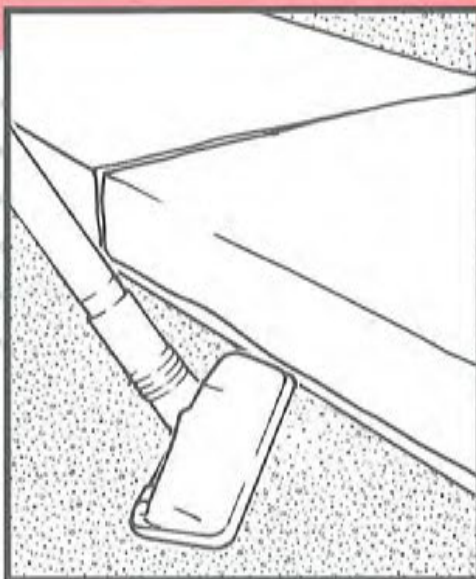

SURFACE NOZZLE

The Surface Nozzle may be used on bare floors or for surface cleaning carpets and under low furniture.

Rubber wheels on the nozzle allow it to glide silently on the surface of hard floors without scratching and vacuum with maximum power.



DUSTER BRUSH

The Duster Brush may be connected to the Attachment Hose or the Extension Tubes to remove dust from any surface, including contoured or irregular surfaces.

CANISTER CLEANER & ATTACHMENTS

Using the Attachments (continued)

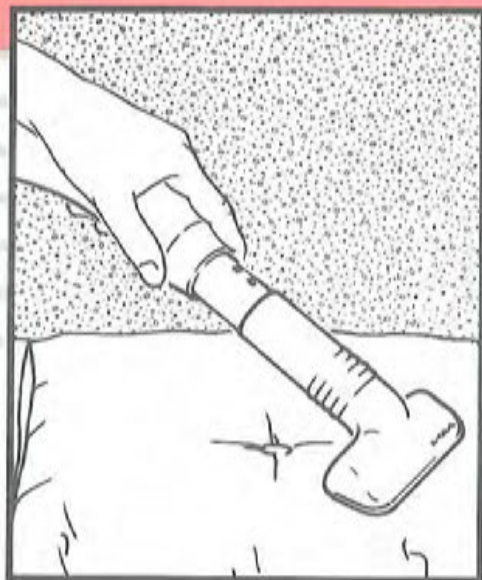

UPHOLSTERY NOZZLE

The Upholstery Nozzle is used for cleaning upholstered furniture, carpeted steps and clothing.

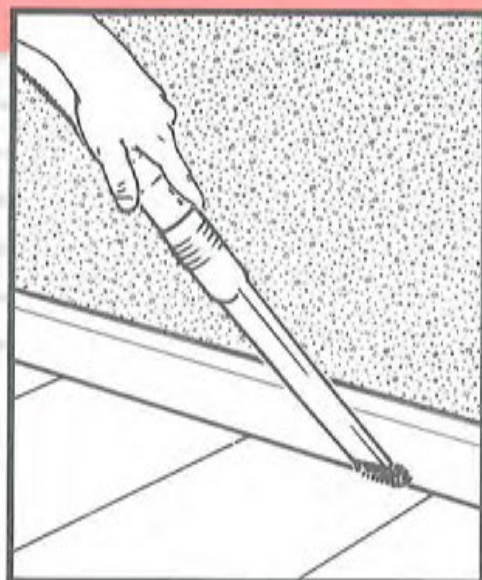

CREVICE TOOL WITH REMOVABLE BRUSH

Without the removable brush, the Crevice Tool can be used for cleaning cracks, crevices, corners, grooves and narrow openings.

Install the removable brush in the end of the Crevice Tool to remove dirt from corners, button tufts, between radiator coils and sliding window tracks.

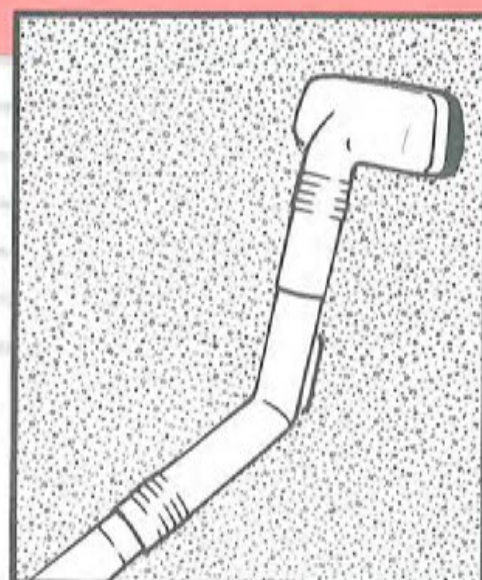

WALL & CEILING BRUSH

Attach the Wall & Ceiling Brush to the end of an Extension Tube to vacuum walls, ceilings, drapes and other surfaces.

NOTE: You may also wish to use the Suction Control Grip as shown on Page 24.

OPTIONAL ACCESSORIES

Using the Attachments (continued)



MASSAGE CUP

Used with the Attachment Hose, the Massage Cup provides an invigorating skin or scalp massage.

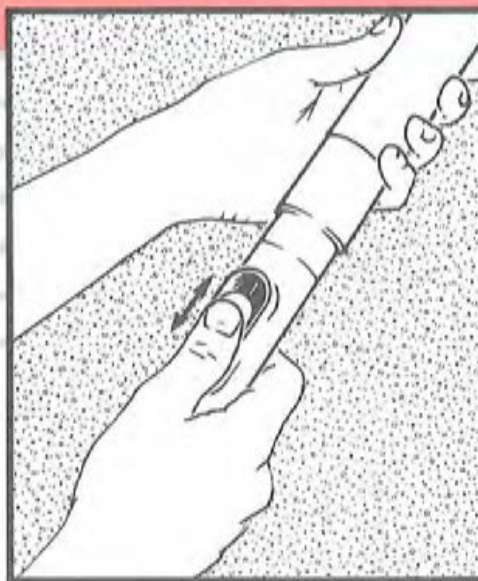

CONTROLLING AIR FLOW WITH THE SUCTION CONTROL GRIP

Sometimes when using the attachments, vacuuming drapes for example, you might wish to control the amount of suction.

The Suction Control Grip features a valve to control the amount of suction. Slide the control back and forth until the desired level of suction is reached.

The Suction Control Grip can be used by itself, or with the Attachment Hose or Extension Tubes.

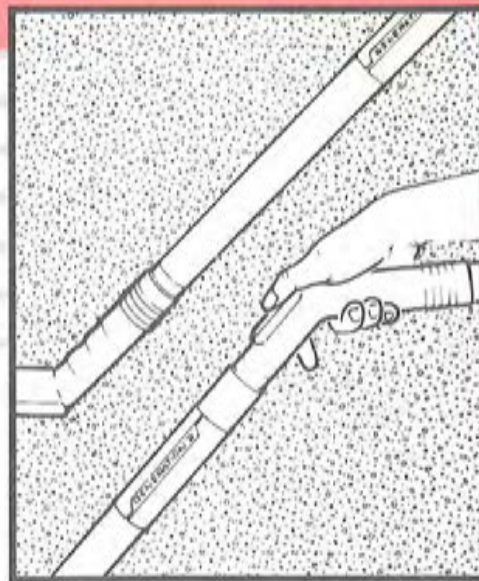

SUCTION CONTROL GRIP PLACEMENT

The Suction Control Grip may be used between Extension Tubes to reach shelves or at the end of Tubes to reach ceilings.

CANISTER CLEANER & ATTACHMENTS

Using Your Generation 3 as a Blower

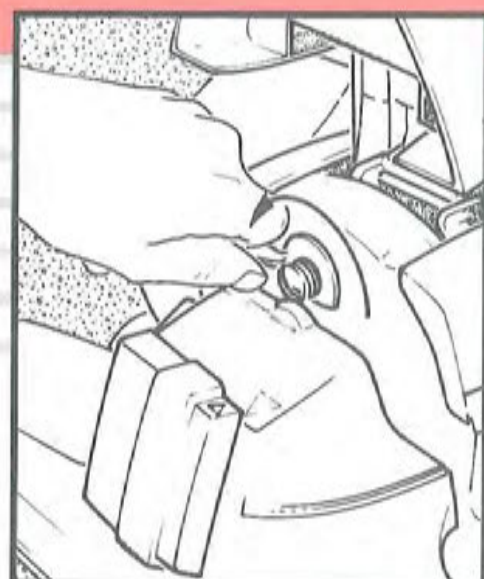
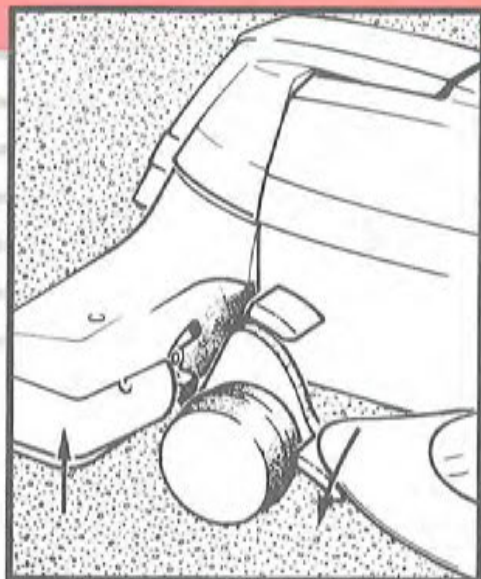

BLOWER SET-UP

Your Generation 3 can also be used as a blower. To do so you must first remove the Power Nozzle (25).

NOTE: When using your Generation 3 as a blower, you may choose between the Upright Handle or the Portable Handle. To install the Portable Handle see column 3 on Page 17.

1 Turn the power OFF, place the Tech-Drive Power Assist in Neutral (see Page 8 for details), unplug the Kirby from the wall outlet and press the Toe-Touch Control bottom pedal (9) all the way down until nozzle is fully raised. ➤

2 Raise the Headlight Hood (21) and turn the Belt Lifter (20) all the way to the left (counter-clockwise) until it stops and the red arrows line up. ➤

3 Unlock the Power Nozzle by turning the Accessory Lock (22) all the way to the left (counter-clockwise). The Power Nozzle should tip forward when it is released. Lift nozzle away from the Kirby and off. ➤

CANISTER CLEANER & ATTACHMENTS

Using Your Generation 3 as a Blower (continued)



BLOWER SET-UP (cont)

4 When using the blower attachments, the Air Intake Guard must be attached to the front of the Kirby.

Fasten the Air Intake Guard onto the Attaching Bar (24) the same way you would the Attachment Hose. Then lock it on by turning the Accessory Lock (22) all the way to the right (clockwise). ➤

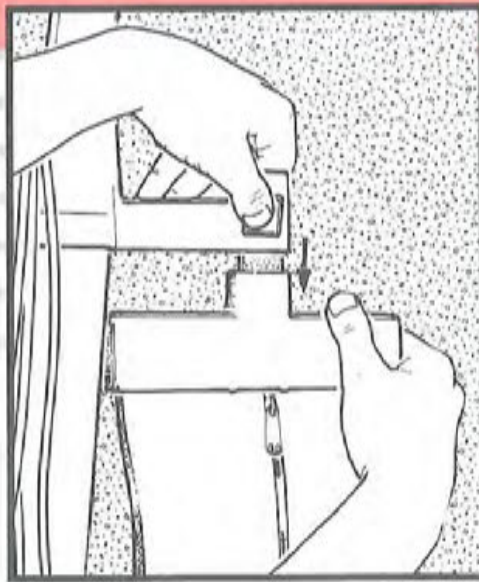

5 Release the Outer Cloth Bag Top from the Bag Support (16) by pressing the Bag Release Button (2) and sliding the bag top off. (See Page 17 for details). Because the Upright Handle is spring loaded, it must be in a vertical position before it is released. ➤

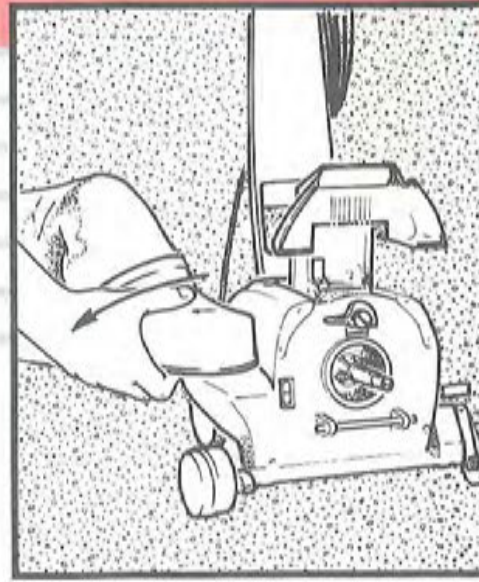

6 To remove the entire Bag Assembly, grasp the Mini Em-Tor (6) in the handhold provided and rotate it out and away from the Kirby as far as it will go. Then lift it off.

(To replace the Bag Assembly after use as a blower, see Page 10.) ➤

CANISTER CLEANER & ATTACHMENTS

Using your Generation 3 as a Blower (continued)

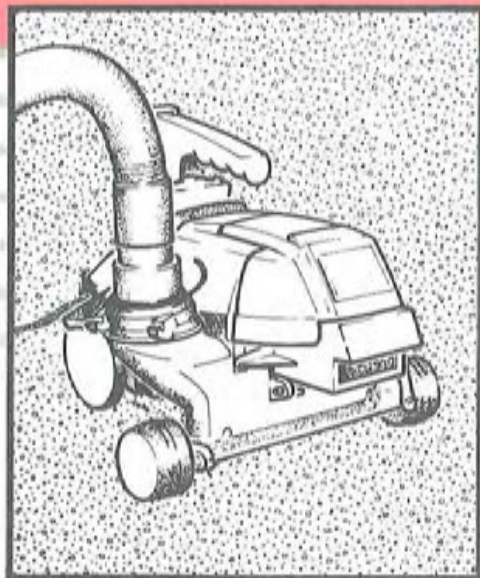

BLOWER SET-UP (cont)

7 Place the large end of the Attachment Hose over the Air Exhaust Port (19). Line up the Indicator Arrow on the Hose End with the Indicator Arrow on the Air Exhaust Port and twist the Hose Connector to the right (clockwise) to lock it in place.

If the Kirby will not operate, see Page 57, column 2, item 4 and 5. □

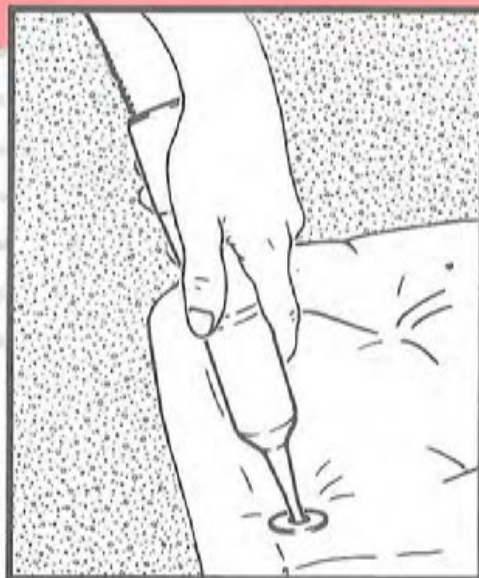

USING YOUR GENERATION 3 AS A BLOWER

Your Generation 3 may now be used as a blower.

By attaching the Inflater/Deflator Tool to the Attachment Hose, you can inflate toys, air mattresses or any other low-pressure inflatable item up to 1 p.s.i. (pounds per square inch of air pressure).

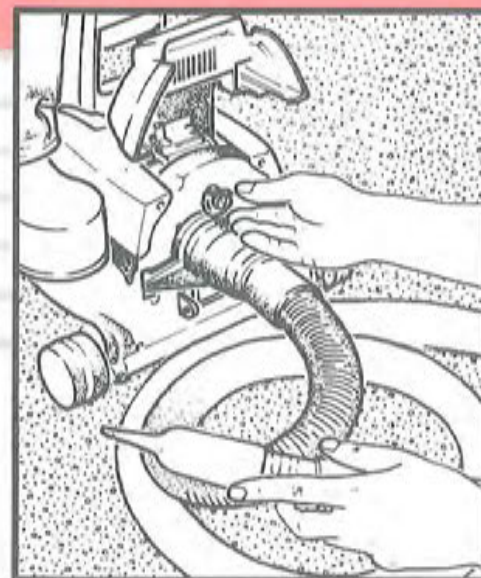

To deflate items, connect the Attachment Hose to the front of the Kirby (see Pages 20-21 for details) and connect the Inflater/Deflator Tool to the Attachment Hose. Then connect the Bag Assembly to the Air Exhaust Port (see Page 10).

You may now use your Kirby to deflate items.

Note: You can also use this set-up to clean tight areas such as computer keyboards and audio/video equipment.

CANISTER CLEANER & ATTACHMENTS

The Portable Sprayer (Blower Mode Only)

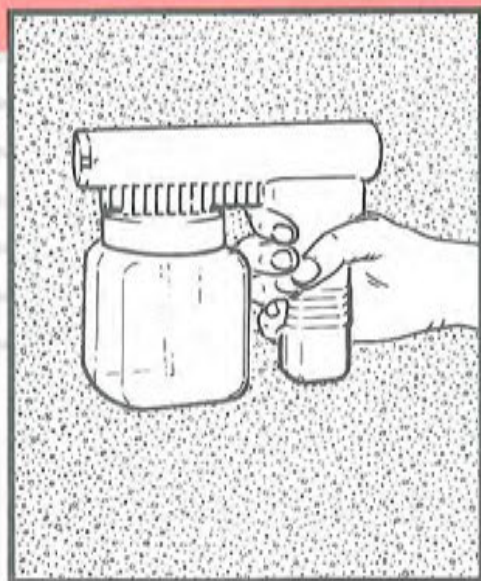

THE PORTABLE SPRAYER

The Portable Sprayer is used only in the Blower Mode. It is an excellent tool to apply many different types of **water-based** liquids to any type of surface. The spray can be adjusted ranging from very fine to coarse.

Some uses are: applying water-based waxes to tile floors, deodorizing pet houses and bedding (try Kirby Odorific mixed with water), applying self-mixed window cleaners, spraying water-based paints or stains (other than in Canada - see warning below) on walls, wood panels and irregular shaped objects. The list goes on.

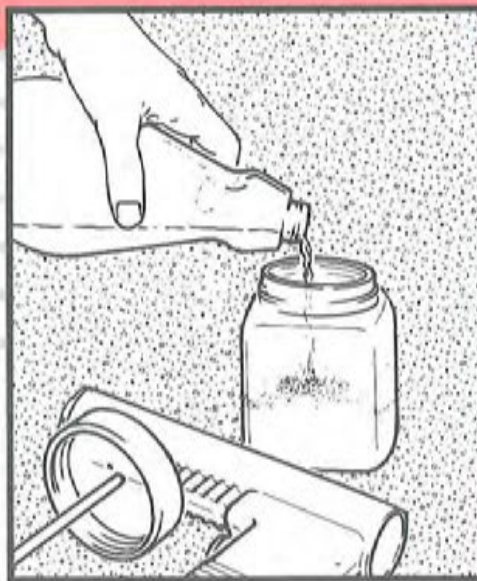

PORTABLE SPRAYER SET-UP

1 Unscrew the jar from the Portable Sprayer and fill 3/4 full with non-flammable liquid. ➤



2 Screw the jar tightly on the Portable Sprayer and attach the Portable Sprayer to the end of the Attachment Hose in the Blower Mode (see Page 25).

(Make certain your Kirby is set up as a Blower Unit. The Attachment Hose should be connected to the Air Exhaust Port (19).) □

⚠ WARNING:

Never use oil or solvent base paint of any kind in the Portable Sprayer. The motor is open to the spray and could ignite flammable and volatile paint solvents. The Portable Sprayer has not been tested or Certified for use with any kind of paint by Canadian Standards Association.

CANISTER CLEANER & ATTACHMENTS

The Portable Sprayer (continued)

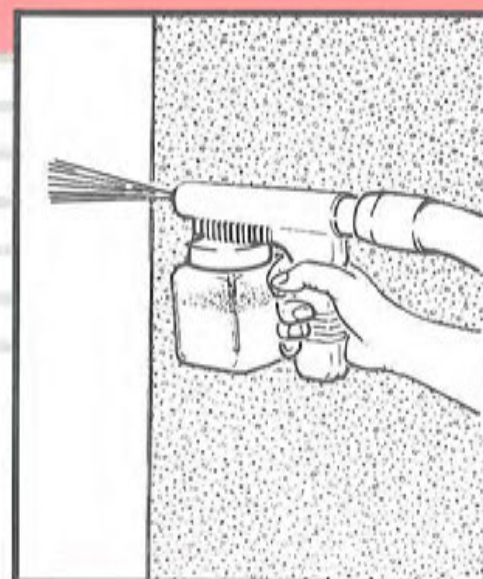
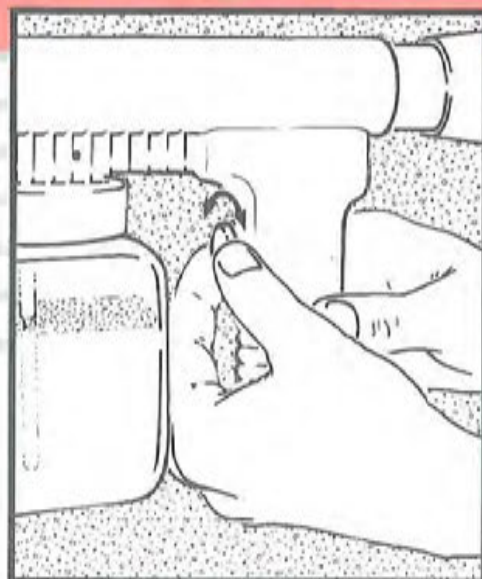

USING THE PORTABLE SPRAYER

1 Holding the Portable Sprayer horizontally, aim it toward a sheet of newspaper. Turn the Kirby ON and squeeze the Portable Sprayer trigger, spraying your water-based paint or non-flammable solution onto the newspaper to check spray pattern.

NOTE: If the Portable Sprayer must be tilted during usage, less solution should be used in the jar. This will help avoid large droplets in the spray. ➤

2 With the nozzle pointed away from you, adjust the spray by turning the Spray Adjustment Control on the trigger of the Portable Sprayer. ➤

3 Use slow, sweeping motions to spray the desired area with solution. Always squeeze the trigger fully to permit maximum flow. This will give you the best spray control. □

CANISTER CLEANER & ATTACHMENTS

The Portable Sprayer (continued)



CLEANING THE PORTABLE SPRAYER

1 Immediately after use, empty the Portable Sprayer jar and fill it with water. Spray water until the spray becomes clear. Then wash the jar with warm soapy water. ➤



2 The Portable Sprayer dip tube should also be removed and washed. (Make sure to reinstall it after cleaning.) ➤



3 The spray opening on the front of the Sprayer also pulls out so that the inside of the Sprayer and the nozzle jet can be cleaned.

To remove the Nozzle Jet, press on the two latches on the front of the Nozzle Jet and pull it out. (The latches must be aligned with holes on the front of the Sprayer when returning the Nozzle Jet to the front of the Sprayer.)

Reassemble the Sprayer after cleaning so none of the parts will be lost. □

⚠ WARNING:

Never clean the Portable Sprayer with flammable cleaning fluids. The motor is open to the spray and could ignite the spray.

CANISTER CLEANER & ATTACHMENTS

The Portable Shampooer (Blower Mode Only)



PORTABLE SHAMPOOER SET-UP

The Portable Shampooer is used in the Blower Mode only (see Page 25 for details). It is designed for fast and easy cleaning of carpeted stairways and areas that are difficult to reach with the Carpet Shampoo System.

1 To set up the Portable Shampooer, attach the Portable Shampooer cap to the end of the Portable Sprayer. ➤



2 Remove the jar from the Portable Sprayer and fill the jar about 3/4 full with Kirby Carpet Shampoo mixture. (Mix according to the instructions on the bottle.) USE ONLY KIRBY INSTANT SUDS for best results. ➤

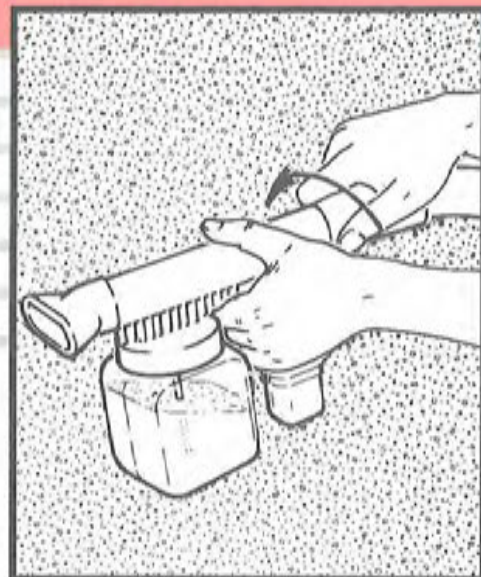

3 Screw the jar tightly on the Portable Sprayer, then attach the Sprayer to the Attachment Hose.

(Make certain your Kirby is set up as a Blower Unit. The Attachment Hose should be connected to the Air Exhaust Port - see Page 27.) □

CANISTER CLEANER & ATTACHMENTS

The Portable Shampooer (continued)

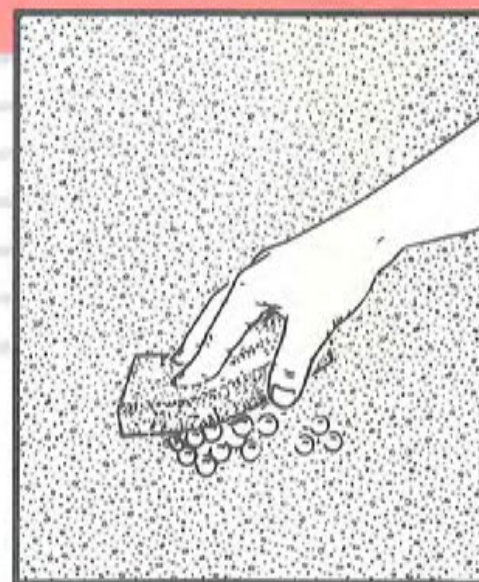
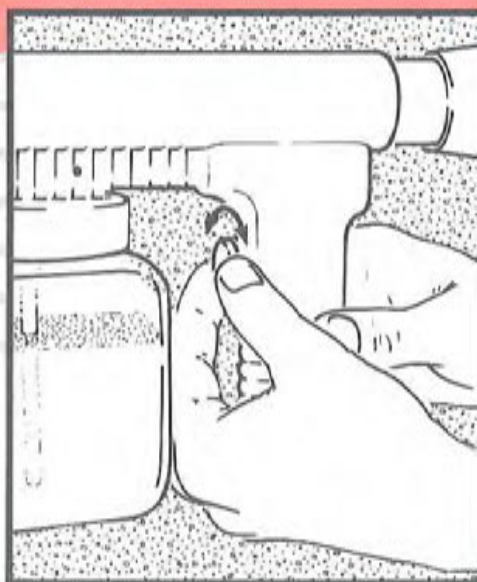

USING THE PORTABLE SHAMPOOER

1 To make suds, turn the Kirby ON and pull the trigger of the Portable Sprayer. A stream of suds will come out of the cap.

The suds can be sprayed directly onto the surface being cleaned, or on a sheet of newspaper and then applied to the surface being cleaned. ➤

2 Adjust the Portable Sprayer for proper suds volume by turning the Spray Adjustment Control located on the trigger. ➤

3 Work suds into the surface with a soft brush or sponge until they disappear. Allow the surface to dry completely.

Then vacuum with the appropriate cleaning tool. This will remove the dry residue which contains grime and loosened dirt.

□

CAUTION:

The Portable Shampooer is not recommended for use on upholstery or fabrics such as silk, brocade and velvet. If in doubt, try a test patch. Let the test patch dry and then check it before you shampoo further.

OPTIONAL ACCESSORIES

P A R T F O U R

Optional Kirby® Accessories greatly enhance the usefulness of your new Generation 3™. In this section, we will discuss the following:

- Using the Carpet Shampoo System.
- Using the Floor Polisher.
- Using the Carpet Fluffer.
- Using the Turbo Accessory Kit™.
- Using the Zippbrush™.

This section will provide the information you need to take advantage of your Kirby Optional Accessories.

OPTIONAL ACCESSORIES

The Carpet Shampoo System



CARPET SHAMPOO SYSTEM SET-UP

1 Turn the Carpet Shampoo System Nozzle Belt Lifter to the right of the center position (fully clockwise) until the green arrows line up. ➤

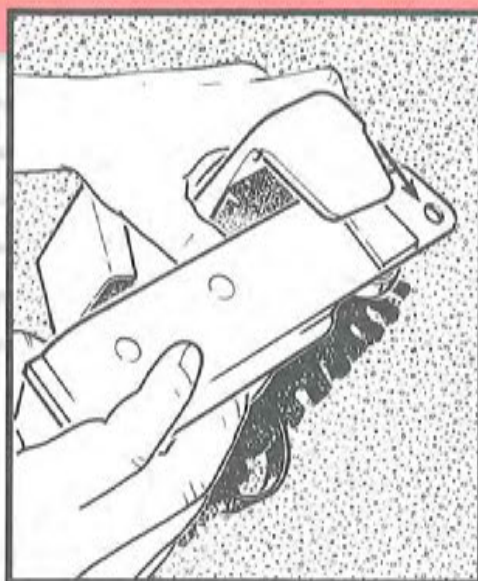

2 Slide the slots on the side of the Carpet Shampoo System Nozzle over the outer shoulders of the Carpet Shampoo System Tray. ➤

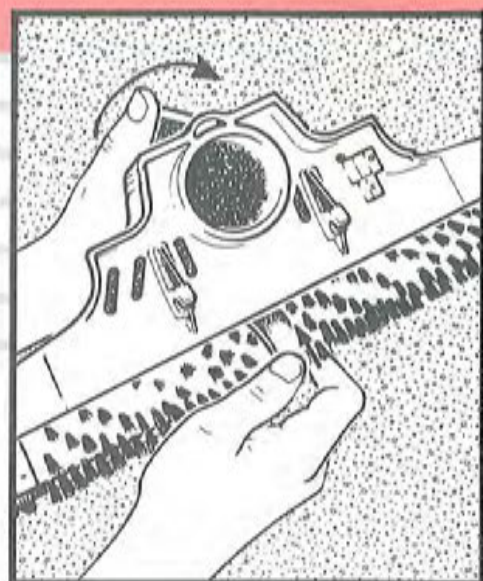

3 While pushing up on the Belt with your finger, turn the Belt Lifter left (counter-clockwise looking at it from the front) until the red arrows line up. (The Belt Lifter Hook will catch and stretch the belt.) ➤

OPTIONAL ACCESSORIES

The Carpet Shampoo System (continued)

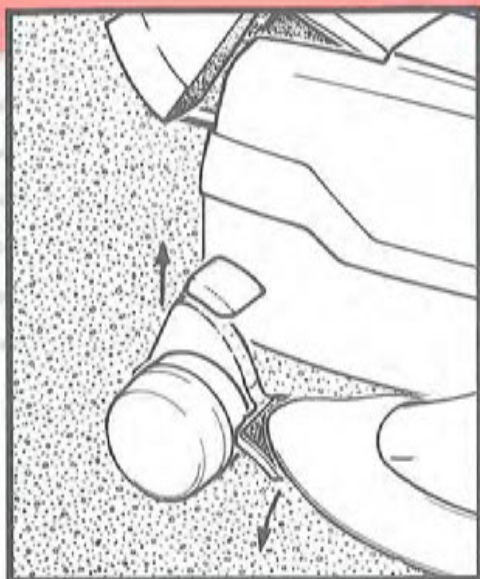

CARPET SHAMPOO SYSTEM SET-UP (cont)

4 Press the bottom Toe Touch Pedal (9) all the way down to raise the front of the Kirby. ➤

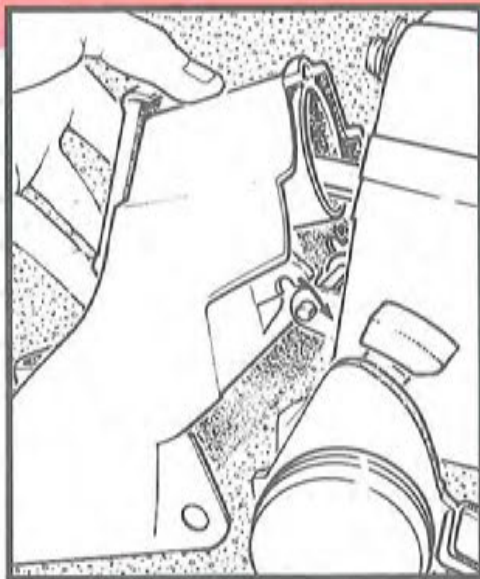

5 While sliding the Carpet Shampoo System Nozzle/Tray Assembly toward the Kirby and over the Motor Shaft (23), connect the hooks on the bottom rear of the nozzle to the Attaching Bar (24). ➤



6 Push the nozzle up against the Kirby and turn the Accessory Lock (22) to the right (clockwise) to lock the nozzle in place. To engage the belt, turn the Belt Lifter all the way to the right (clockwise) until the green arrows line up. Then lower the Headlight Hood (21). ➤

OPTIONAL ACCESSORIES

The Carpet Shampoo System (continued)

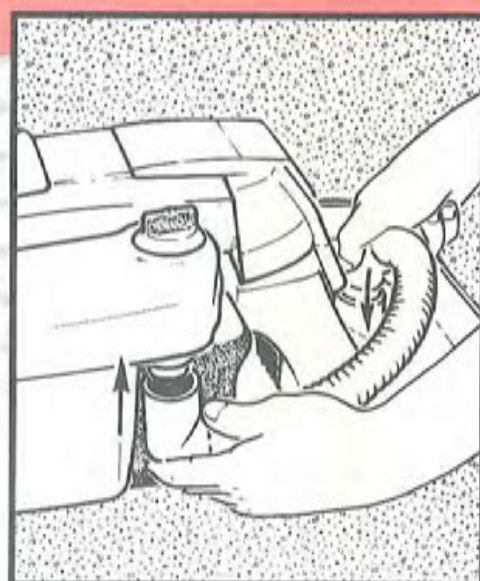
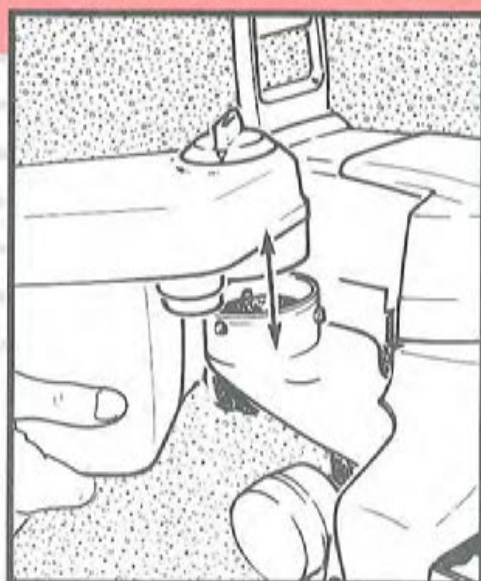
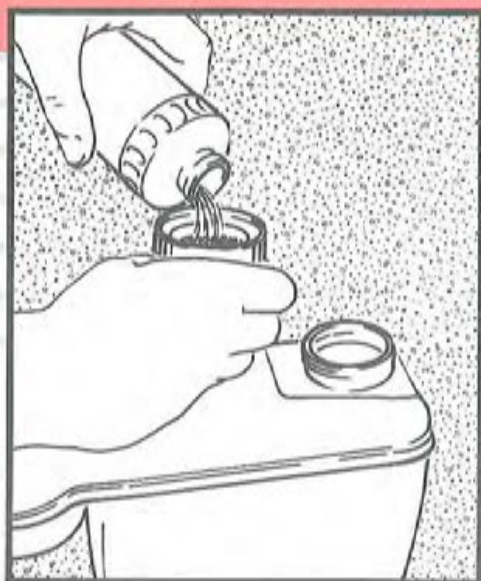

CARPET SHAMPOO SYSTEM SET-UP (cont)

7 The Tank is removable and should be filled or emptied at your sink.

NOTE: Tank is removed and re-attached in the same way as the Mini Em-Tor (see Page 10 for details).

Unscrew the large cup from the top of the tank and turn the Suds Control Valve fully to the left (counter-clockwise) to OFF.

Holding the tank level, fill tank to the full line with warm water (not hot).

Pour three capfuls of Kirby Carpet Shampoo into the tank. Do not use more, as over-foaming will result.

NOTE: One tankful of solution will clean about a 9x12 foot carpet. Larger carpets will require emptying the tray and refilling the tank.

Replace the large cup into the opening on top of the tank. ➤

8 Taking care to avoid spilling liquid on the Kirby or the floor, place the opening in the bottom front of the tank over the Air Exhaust Port (19) on the Kirby. Angle the tank outward from the Kirby until the arrows line up. Next, slide the tank down over the locking pins on the Air Exhaust Port.

Rotate the tank toward the Kirby to lock it in place. ➤

9 Push the smooth, round elbow at the end of the Small Flexible Hose over the fitting at the bottom front of the tank.

Insert the other end firmly into the hole in the tray. □

CANISTER CLEANER & ATTACHMENTS

The Carpet Shampoo System (continued)

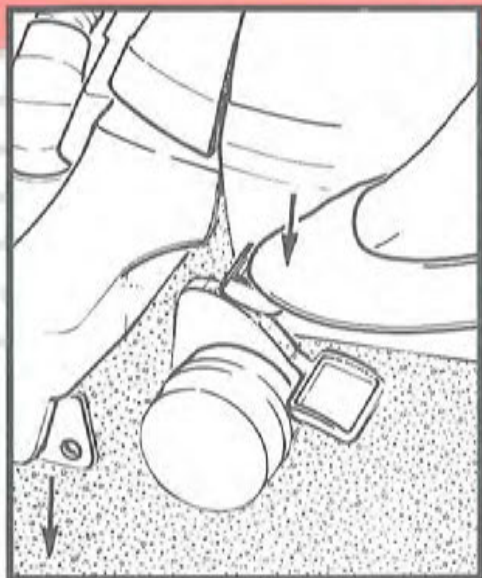

USING THE CARPET SHAMPOO SYSTEM

1 To set the nozzle to the proper height, step on the Toe Touch Control upper pedal (8) as often as necessary to lower the nozzle to its lowest position. ➤



2 Turn the Suds Control Valve all the way to the right (clockwise) to the ON position.

Control the amount of suds by turning the Suds Control Valve left for less suds flow and right for increased suds. Turning the valve all the way to the left (counter-clockwise) to the off position will stop the flow of suds completely.

Stopping the flow of suds allows you to thoroughly brush all the suds into the carpet before applying more suds. This also lets you spot scrub badly soiled areas. ➤



3 Turn the Kirby ON and engage Tech-Drive Power Assist (see Page 8 for details). As you move the Kirby back and forth, foam will be released and the brush will work it into the carpet.

You should soon notice a band of foam being brushed into the tray.

NOTE: Suds should be dispensed the full width of the tray when the Kirby is pulled backward. If not, pull back more slowly or check and clean the Suds Tank Filter if necessary (see Page 40).

Suds will build up quickly in the tray if the Kirby is not kept moving when the motor is turned on, or if the Kirby is moved too slowly.

To fluff carpets after using the Carpet Shampoo System, see Page 46. □

OPTIONAL ACCESSORIES

The Carpet Shampoo System (continued)

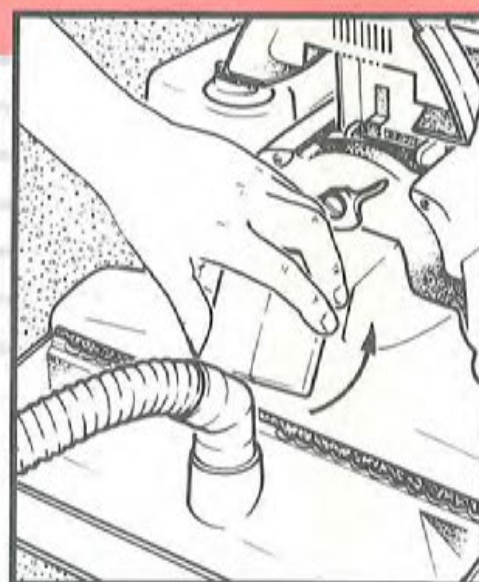
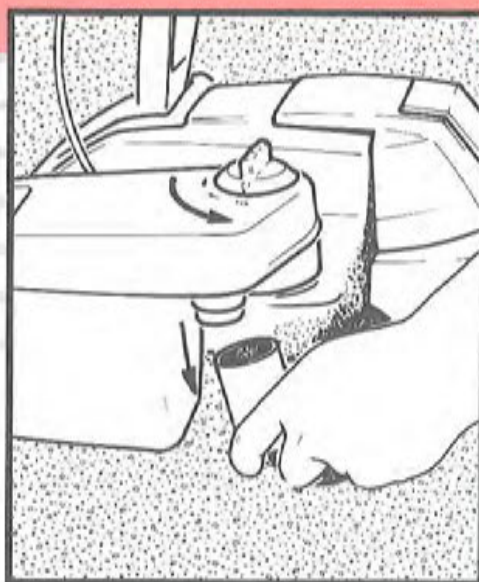
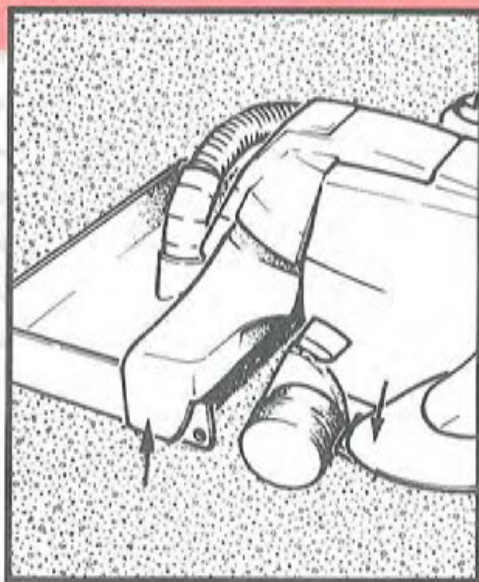

CLEANING THE CARPET SHAMPOO SYSTEM

1 Turn the Kirby OFF, unplug and push the Toe-Touch Control bottom pedal (9) all the way down to raise the nozzle and tray. ➤

2 Turn the Suds Control Valve fully to the left (counter-clockwise) to the OFF position.

Pull the Small Flexible Hose from the tank, but not from the tray. ➤

3 Raise the Headlight Hood (21). Release the belt by turning the Belt Lifter to the left (counter-clockwise) until the red arrows line up. ➤

OPTIONAL ACCESSORIES

The Carpet Shampoo System (continued)

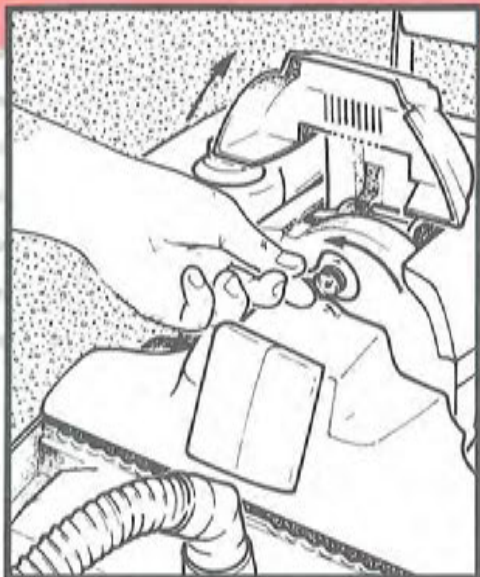

CLEANING THE CARPET SHAMPOO SYSTEM (cont)

4 Turn the Accessory Lock (22) to the left (counter-clockwise). The Carpet Shampoo System Nozzle/Tray Assembly will tip forward.

Lift the Nozzle/Tray Assembly off the Kirby and carry it to the sink. ➤

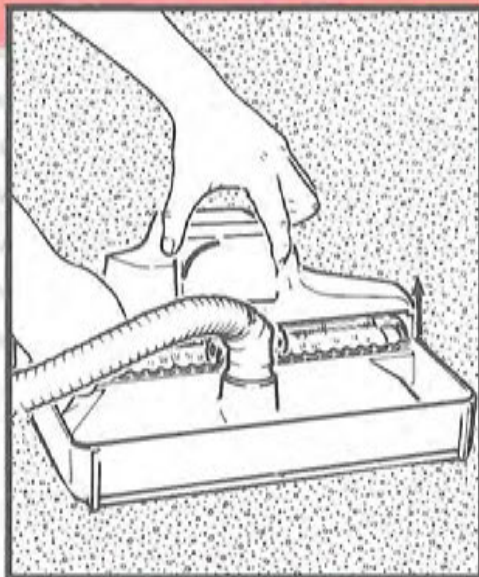

5 Turn the Belt Lifter to the right (clockwise) until the green arrows line up. Pull the tray and nozzle apart. ➤

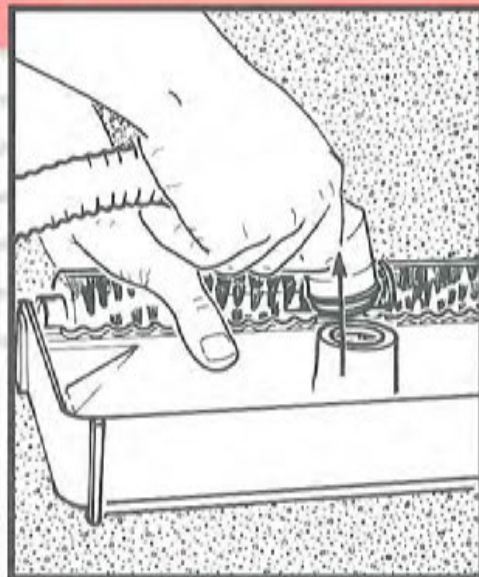

6 Remove the hose from the tray and rinse them both. ➤

OPTIONAL ACCESSORIES

The Carpet Shampoo System (continued)

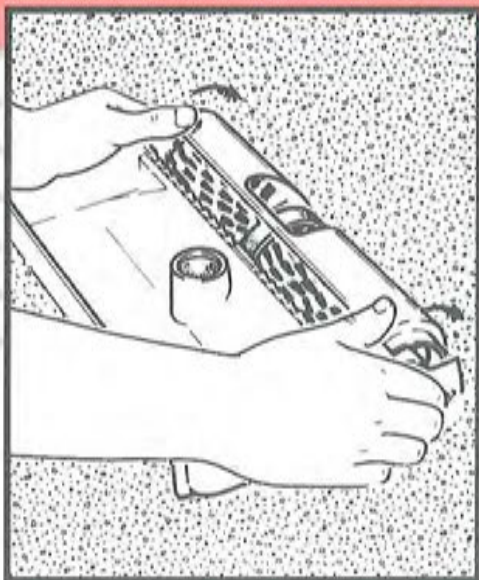

CLEANING THE CARPET SHAMPOO SYSTEM (cont)

7 To clean the brush, push the thumb pads located at each end of the clear plastic shield and rotate the shield up and away from the brush.

Rinse all areas of the shield and brush and remove any lint from brush tufts.

Shake excess water from the Brush Roll.



8 To remove the tank from the Air Exhaust Port (19), rotate it away from the Kirby as far as it will go, then lift it upwards. ➤

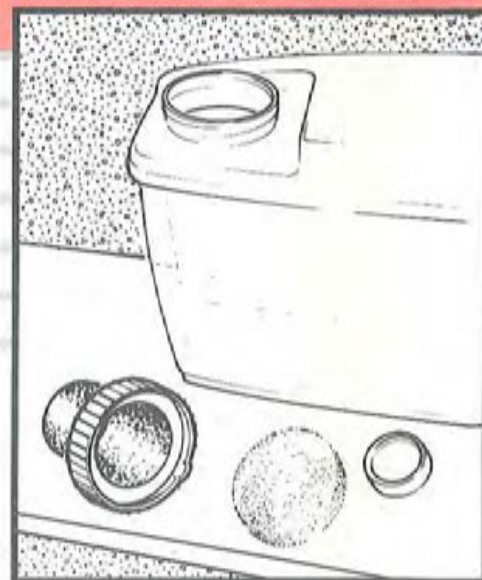

9 Remove and clean the Suds Screen Cap, Cup and Sponge Filter.

Rinse out the tank and replace the Screen Cap, Cup and Sponge Filter.

NOTE: The belt should not be stretched when stored away for extended periods. Make sure the green arrows on the nozzle line up for storage. (Remember to align the red arrows before replacing the nozzle on the Kirby - see Belt Lifter section on Page 11.) □

OPTIONAL ACCESSORIES

The Carpet Shampoo System (continued)



REPLACING A WORN CARPET SHAMPOO SYSTEM NOZZLE BELT

1 To replace the Carpet Shampoo System Nozzle Belt, push the thumb pads located at each end of the shield and rotate the shield up and away from the brush. ➤

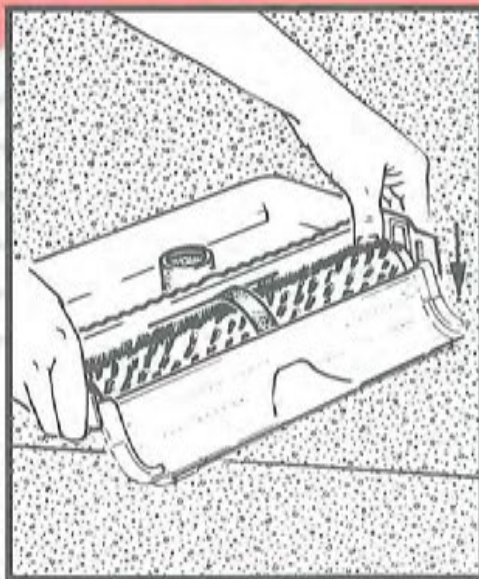

2 Push down carefully on the ends of the brush with your thumbs. The brush will snap out and the belt can be replaced.

Be certain the belt is placed in the center of the brush. **NOTE:** Use only approved Kirby belts. ➤

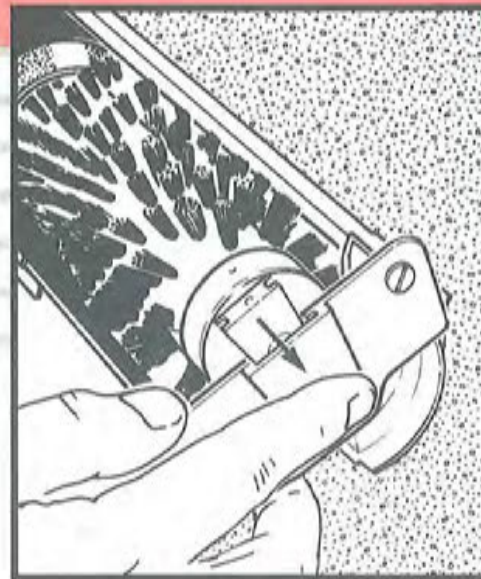

3 Align the metal ends of the brush with the slots on the tray and push the brush in until it snaps into place. The brush will only fit the tray the correct way.

Note: The belt should not be stretched when stored for an extended period. Make sure the green arrows line up for storage (see Page 11 for discussion of the Belt Lifter). □

OPTIONAL ACCESSORIES

The Floor Care Kit—Floor Polisher

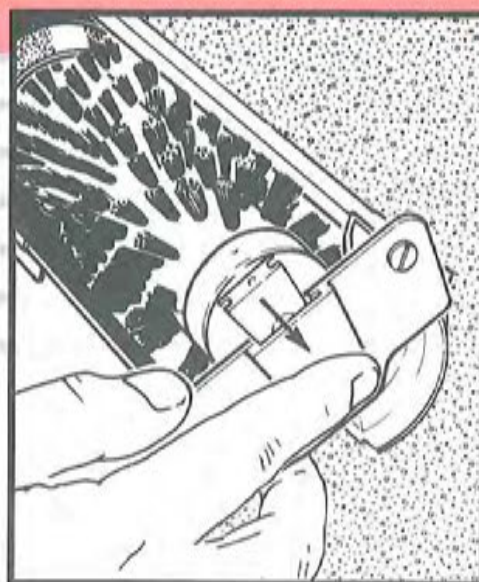
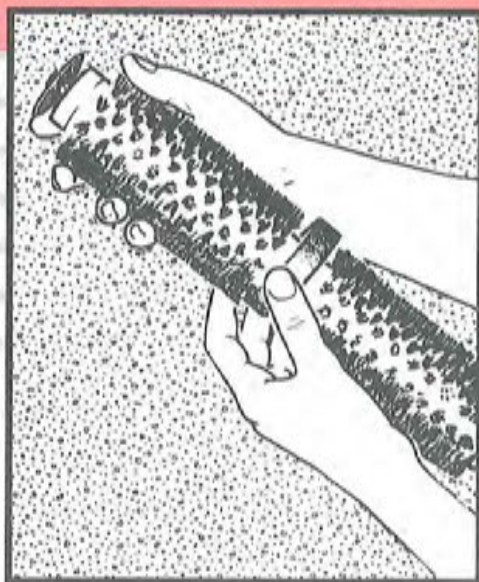

FLOOR POLISHER SET-UP

Your Generation 3 can be used as an effective Floor Polisher for wood or tile floors.

To use the Floor Polisher, you must first insert the Polisher Brush into the Floor Polisher Nozzle.

NOTE: Use only approved Kirby belts.

1 Center the Belt of the Polisher Brush in the middle area between the tufts of the brush. ➤

2 Turn the Accessory Brush Nozzle over and slide the ends of the Brush into the slots at each end of the nozzle. The Polisher Brush will only fit the correct way. ➤

3 Push the belt up against the Brush Roll with your finger. ➤

OPTIONAL ACCESSORIES

The Floor Care Kit—Floor Polisher (continued)

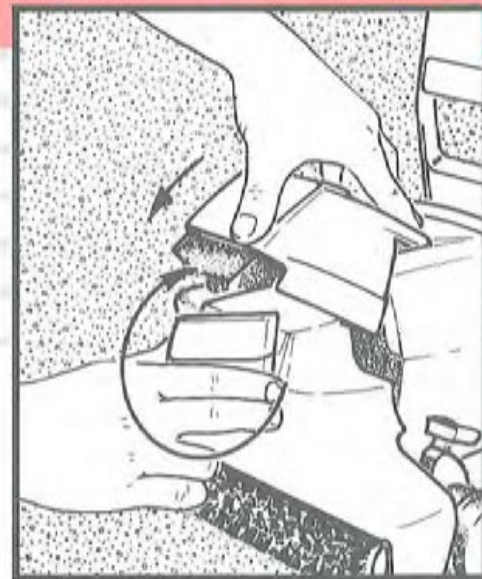
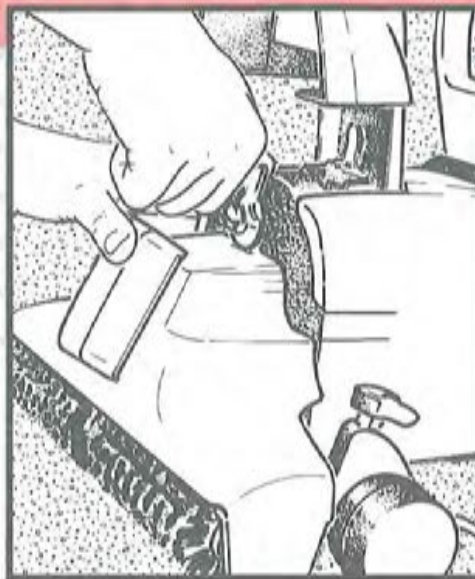

FLOOR POLISHER SET-UP (cont)

4 While holding the belt in place, turn the Belt Lifter to the left (counter-clockwise) until the red arrows line up. The Belt Lifter hook will catch the Belt and stretch it upward into the nozzle. ➤

5 Place the hooks located on the rear of the nozzle over the Attaching Bar(24) and push the nozzle up against the Kirby.

Turn the Accessory Lock (22) to the right (clockwise) to lock the nozzle in place. ➤

6 To engage the drive belt and Polisher Brush, turn the Belt Lifter all the way to the right (clockwise) until the green arrows line up. Lower the Headlight Cap (21). ➤

OPTIONAL ACCESSORIES

The Floor Care Kit—Floor Polisher (continued)

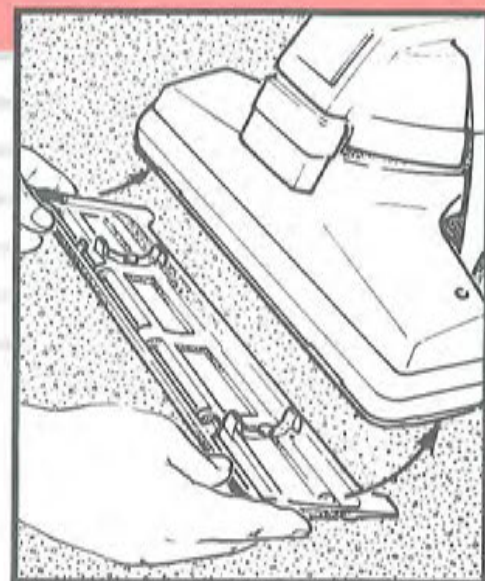
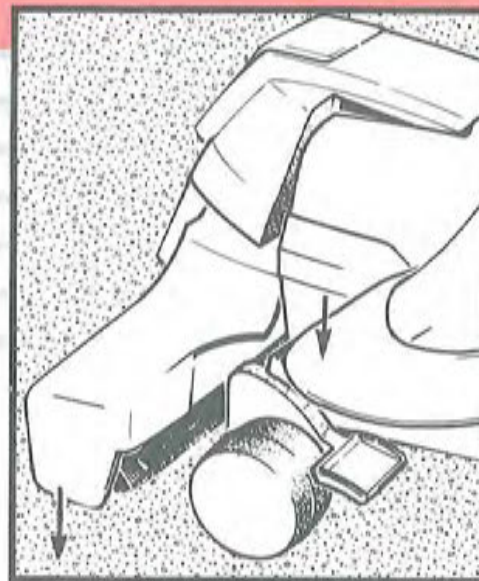
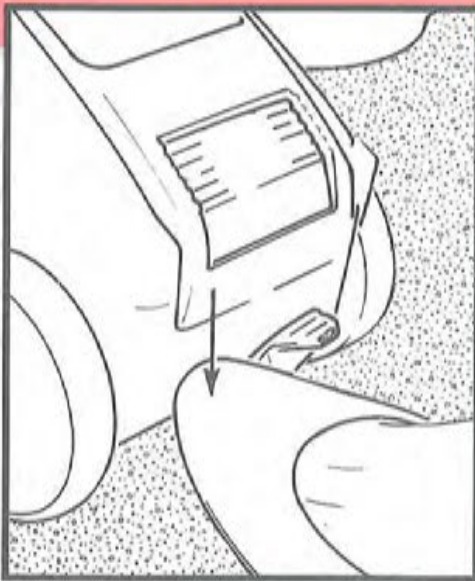

FLOOR POLISHER SET-UP (cont)

7 DO NOT USE TechDrive Power Assist with the Floor Polisher.

Place TechDrive Power Assist in Neutral by stepping on the white "N" SIDE ("N" for Neutral) of the TechDrive Power Assist N/D Pedal (11). ➤

8 Press the Toe-Touch Control upper pedal (8) to lower the brush one notch at a time. Lower the brush as far as the Toe-Touch Control will allow. □

HARD FLOOR PAD

See Page 16 for set-up and use of the Hard Floor Pad.

OPTIONAL ACCESSORIES

The Floor Care Kit—Floor Polisher (continued)

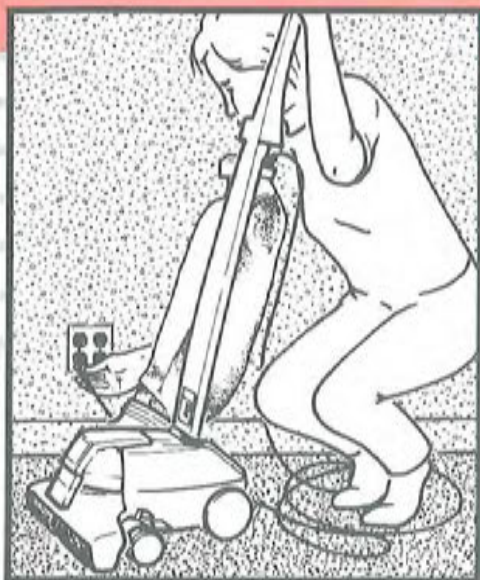

USING THE FLOOR POLISHER

Because the machine moves forward when the Floor Polisher Brush touches the floor, make sure to hold the handle while turning the Kirby ON.

With the polisher running, move the Kirby over the floor as though you were cleaning a carpet, using slow, steady strokes.

⚠ CAUTION:

To avoid having the polisher run away from you when brush is on the floor surface, hold on to the handle before turning the power switch ON or before plugging the power cord into the wall outlet. To avoid possible damage to soft tiles or marking of waxed and finished non-carpeted floors, disengage the TechDrive.

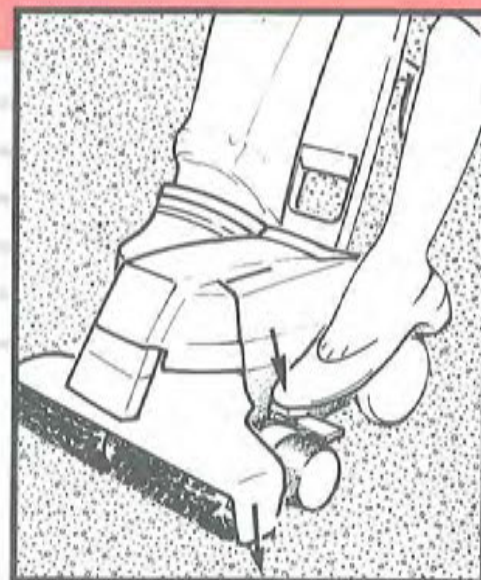
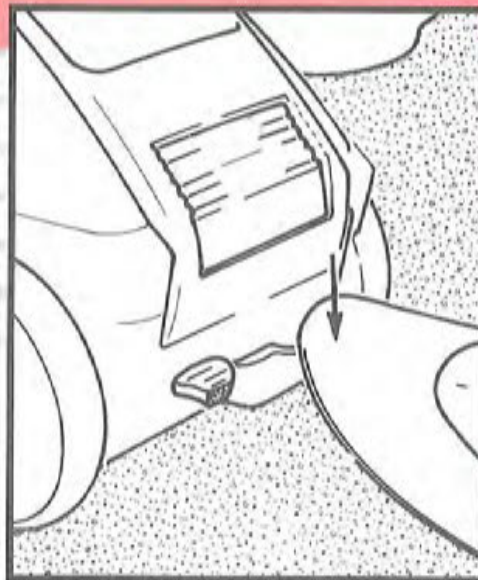
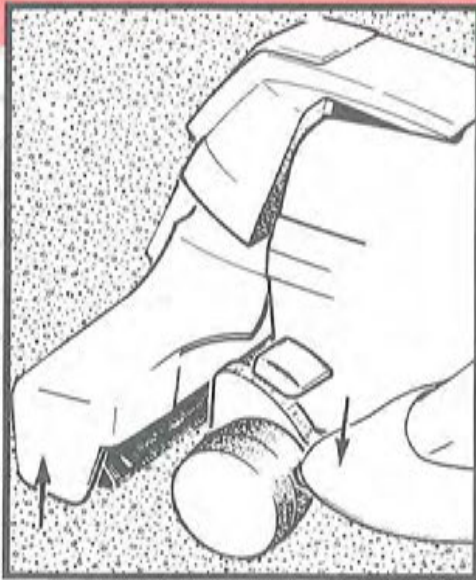

USING THE CARPET FLUFFER

Your Generation 3 Floor Polisher can also be used as a Carpet Fluffer to reset the nap on a matted-down carpet.

1 Before placing the cleaner on the carpet, raise the nozzle all the way up by pushing the Toe-Touch Control bottom pedal (9) all the way down.

Place the cleaner on the carpet to be fluffed. ➤

2 Plug in the Power Cord and engage the TechDrive Power Assist by pushing down on the green "D" SIDE ("D" for Drive) of the TechDrive Power Assist N/D Pedal (12). ➤

3 Start the cleaner and leave the handle in the upright position.

Holding onto the handle firmly, lower the nozzle one notch at a time by pushing the Toe-Touch Control upper pedal (8).

The instant you feel the Kirby starting to move, stop lowering the brush and push the cleaner back and forth over the carpet. (Lowering the brush too far on cable yarn type carpets may cause the carpet to fuzz.)

Do not fluff delicate carpets. □

OPTIONAL ACCESSORIES

The Turbo Accessory Kit

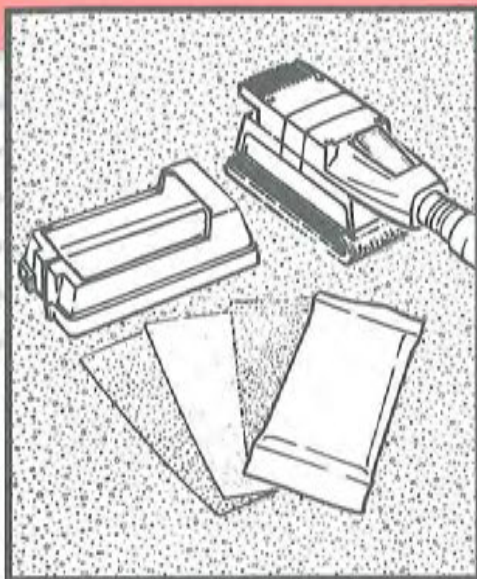

TURBO ACCESSORY SET-UP

The Turbo Accessory Kit can be used for a wide variety of household jobs. It's a sander, a buffing unit, a scouring unit and a massage unit.

TURBO-SANDING

1 To set up the Turbo Accessory Kit as a sander, unsnap the Sander Dust Shroud at the rear of the tool and pull it off. ➤

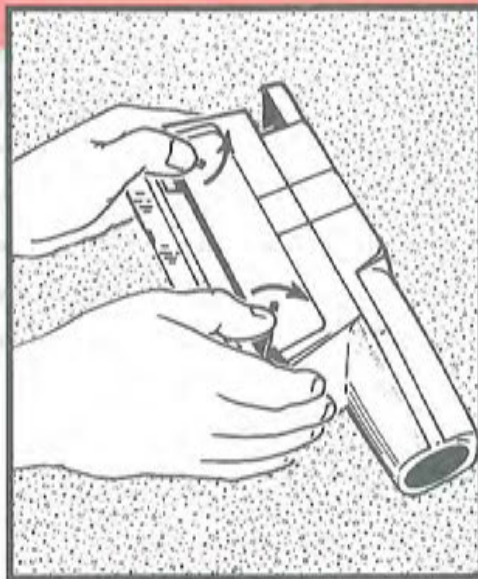

2 Rotate the clamp levers on the side of the Turbo Accessory upwards to open the clamps. ➤

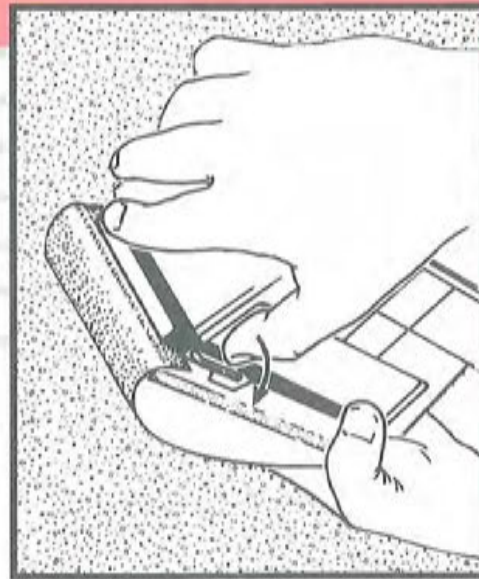

3 Select the correct grade of sand paper needed for the job. Use fine paper for a smooth finish and coarse paper to clean rough surfaces or remove paint.

Slide the sheet into the front clamp and lock the clamp lever. ➤

OPTIONAL ACCESSORIES

The Turbo Accessory Kit (continued)

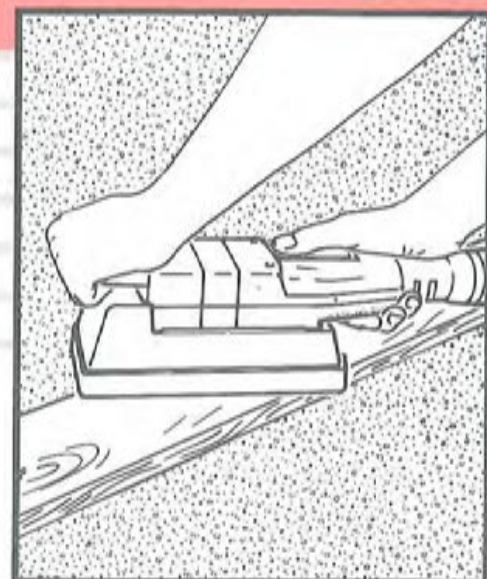
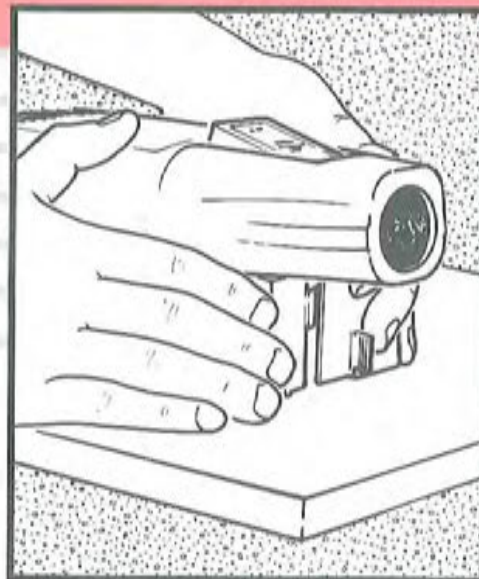
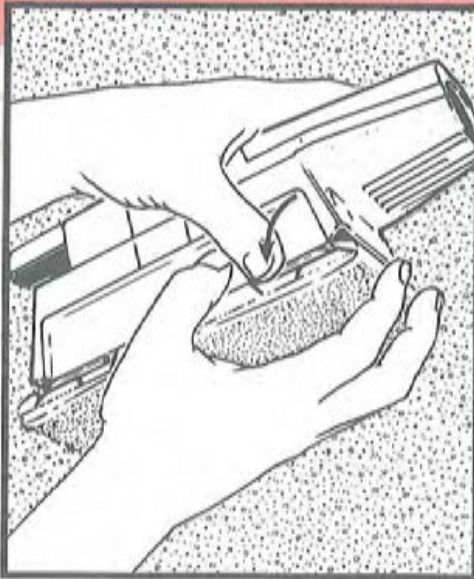

TURBO-SANDING SET-UP (cont)

4 Tightly wrap the paper around the bottom of the Turbo Accessory and tuck the end into the rear clamp. Lock the rear clamp. ➤

5 With the Turbo Accessory on a level surface, wrap the Sander Dust Shroud around the sander with the opening to the rear and snap it closed. ➤

6 Insert the Attachment Hose into the end of the Turbo Accessory.

Grip the sander at the front and rear and turn the Kirby ON. Then press the ON button on the top of the sander.

While applying light pressure, move it over the surface slowly. Allow the sander to do the work. Don't force it or lean heavily on it. The tool works best at high speed. □

⚠ CAUTION:

Be sure no metal objects such as tacks, nails, etc. are sticking up from the surface. They can damage the sand paper and the Turbo Accessory. They may also cause sparks which could ignite dust. Replace the disposable bag after extended sanding because the dust is fine and will plug the bag pores.

OPTIONAL ACCESSORIES

The Turbo Accessory Kit (continued)

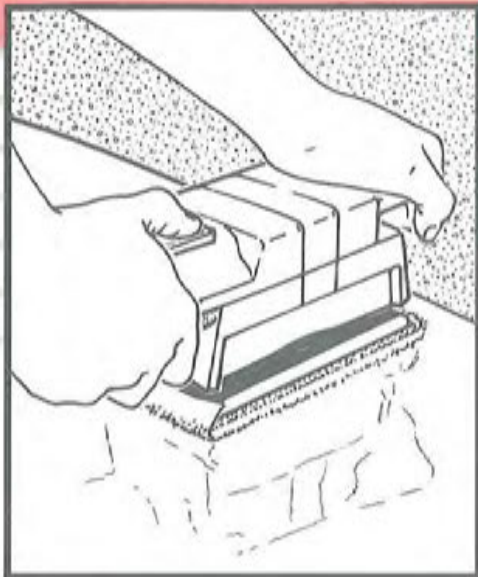

TURBO POLISHING

Attach the synthetic lambs wool pad using the same procedure as attaching sand paper (see Page 47). The Turbo Accessory now becomes a polisher. Use it for polishing hard waxed surfaces such as table tops, panelling and large, flat surfaces.

The Dust Shroud is not used when polishing.



TURBO SCOURING

Attach the webbed nylon scouring pad using the same procedure as attaching sand paper (see Page 47). The Turbo Accessory now becomes a scouring tool. Use it for scouring hard surfaces such as ceramic tile, etc. (Do not use on painted surfaces.)

The Dust Shroud is not used when using the scouring pad.



ORBITAL MASSAGE UNIT

The Turbo Accessory Massage Unit is intended for use where massage is desired or medically recommended.

To use as an Orbital Massage Unit, attach the soft vinyl pad to the Turbo Accessory using the same procedure as attaching sand paper (see Page 47).

The Dust Shroud is not used when using the Turbo Accessory as a massage unit.

⚠ CAUTION:

Do not use the orbital massager on swollen or inflamed areas, legs with varicose veins, areas where there are skin eruptions, unexplained calf pains or anesthetic skin areas unless first approved by your doctor. Children must be supervised when using the massager.

OPTIONAL ACCESSORIES

The Zippbrush

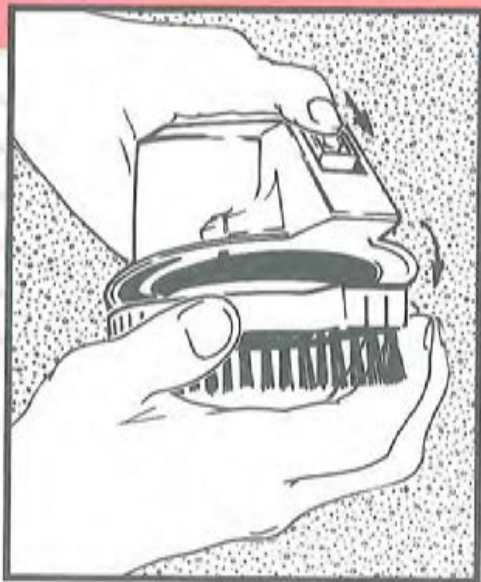

USING THE ZIPPBRUSH

When attached to the Attachment Hose, the Zippbrush can be used for a wide variety of cleaning jobs including upholstery cleaning.

For optimum results, do not press down heavily on the Zippbrush. Allow the brush to rotate at maximum speed by gently moving it side to side on the surface being cleaned.

CLEANING THE ZIPPBRUSH

1 To clean the Zippbrush, press the button on the front of the brush to release the outer brush ring. ➤

2 Lift the center Brush/Air Turbine out of the tool and remove any particles or lint from the brush and turbine. Also remove any particles left in the tool cavity. ➤

3 Place the Brush/Air Turbine back into the tool and turn it until the tabs drop into the slots. Hook the tab on the rear of the ring brush into the small opening of the tool and snap it back into place. □

⚠ CAUTION:

Do not insert fingers into the revolving brush area, or push the release button while the brush is in motion. Keep brush flat against the surface being cleaned as the brush can throw particles outward. Do not use on delicate fabrics.

OPERATING/ MAINTENANCE TIPS

P A R T F I V E

Your Kirby® Generation 3™ is a highly sophisticated home maintenance system. As with most modern appliances, it requires a modest degree of routine maintenance to keep it operating efficiently. This section of the Owner's Manual presents tips on operating and maintaining your Generation 3. In this section, we will discuss the following:

- Changing the Power Nozzle Belt.
- Adjusting the Brush Roll for optimum performance.
- Helpful Answers to Questions.

This section will provide the information you need to keep your Generation 3 operating at peak efficiency.

OPERATING/MAINTENANCE TIPS

Changing the Power Nozzle Belt

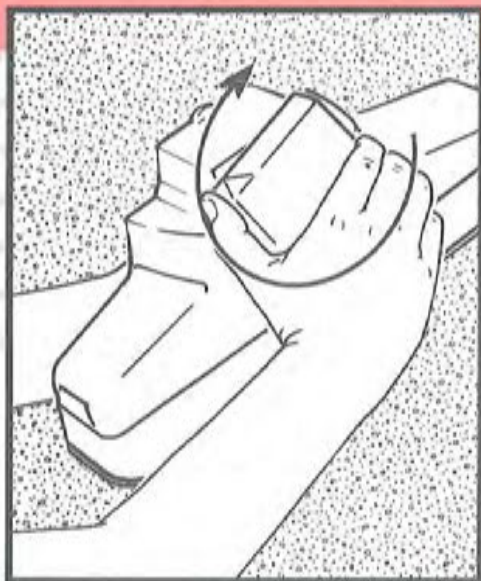

CHANGING THE POWER NOZZLE BELT

After extended use, the Power Nozzle Belt on your Generation 3 may become stretched and worn causing the belt to slip. (See Page 12 - Brush Roll Indicator Light.) If this condition exists, simply replace the old belt with a new one.

NOTE: Use only approved Kirby belts.

1 To change the Belt, remove the nozzle from the Kirby as on Page 20. Then release the belt tension by turning the Belt Lifter (20) all the way to the right (clockwise) until the green arrows line up. ➤

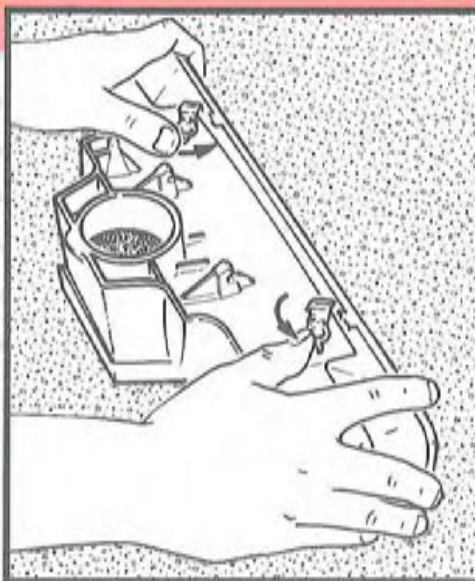

2 Unlock the Rug Plate (26) by unhooking the two latches on the rear of the nozzle.

Pull on the rear edge of the Rug Plate to remove from the nozzle. ➤

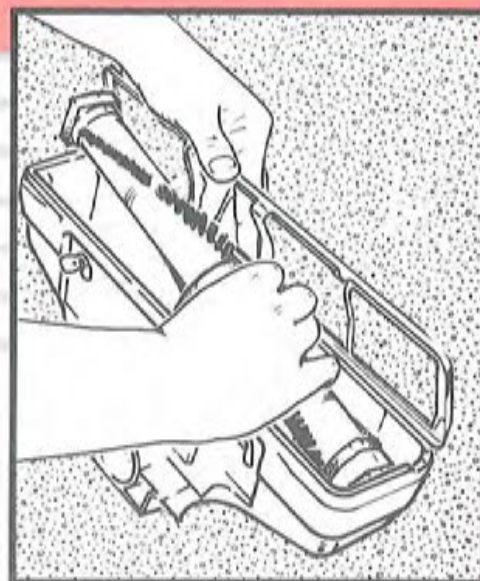

3 Lift out the Belt and Brush Roll. ➤

OPERATING/MAINTENANCE TIPS

Changing the Power Nozzle Belt (continued)



CHANGING THE POWER NOZZLE BELT (cont)

4 Slide off the old belt and replace with a new one. ➤



5 Make sure the adjustment setting (I, II or III) is the same as when the brush was removed. See Page 55 for discussion of the Brush Roll Adjustment (I, II or III). Place the Belt and Brush Roll back into nozzle. It will only fit the correct way.

Then center the Belt on the Brush. ➤

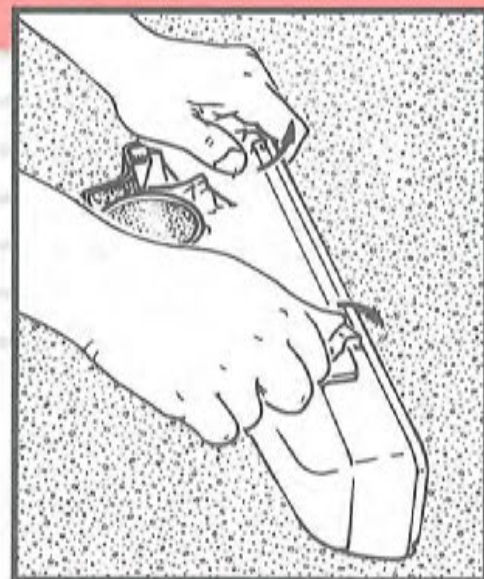

6 Replace the Rug Plate and latch the two locks that hold it in place. ➤

OPERATING/MAINTENANCE TIPS

Changing the Power Nozzle Belt (continued)

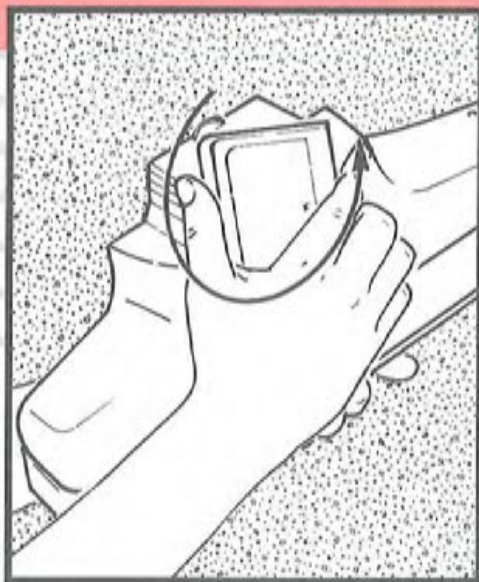

CHANGING THE POWER NOZZLE BELT (cont)

7 Turn the Belt Lifter to the left (counterclockwise) until the red arrows line up. This will stretch the belt in preparation for returning the nozzle to the Kirby. ►

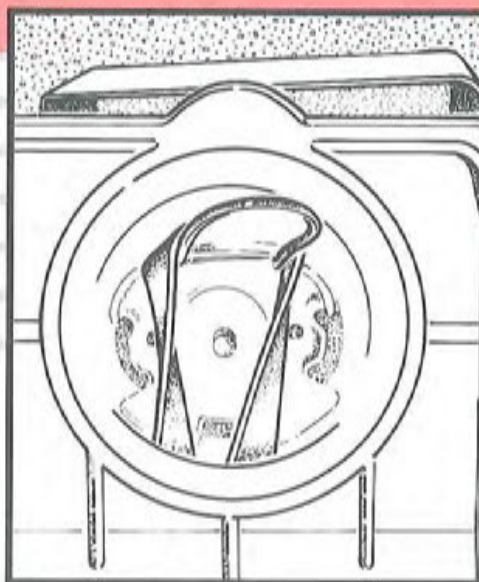

8 The belt will be stretched to the top of the nozzle as shown above.

Now you are ready to re-attach the Power Nozzle and re-engage the belt (see Page 11 for details). □

OPERATING/MAINTENANCE TIPS

Brush Roll Adjustment

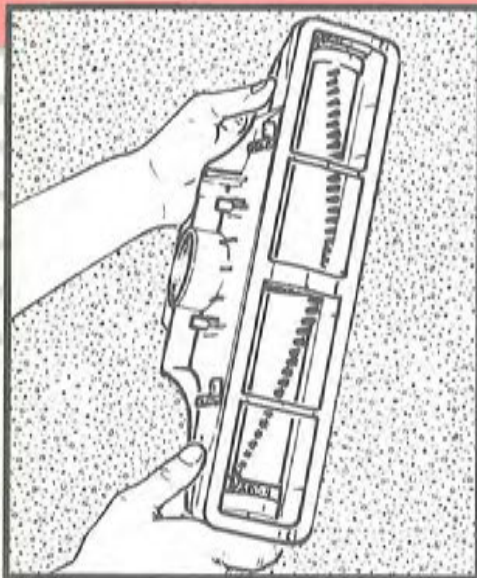

ADJUSTING THE BRUSH ROLL FOR OPTIMUM PERFORMANCE

The Brush Roll bristles wear away after long periods of usage and this condition will reduce cleaning efficiency.

Adjustments at the ends of the Brush Roll are designed to adjust the brush so it works like new again.

The Brush Roll on a new Kirby has the ends positioned to show the Roman Numeral I. Two more positions marked II and III may be used when the bristles become worn. To check for worn bristles, do the following: ➤

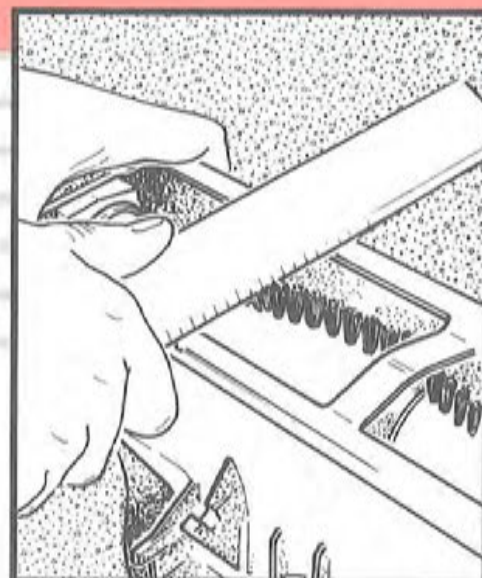

1 Remove the Power Nozzle from the Kirby as on Page 20. ➤

2 Turn the Power Nozzle over and place a ruler against the Metal Rug Plate (26). If the bristles are below or just touching the ruler, the Brush Roll should be adjusted to the next highest setting.

If this is required, proceed to the following step. ➤

OPERATING/MAINTENANCE TIPS

Brush Roll Adjustment (continued)

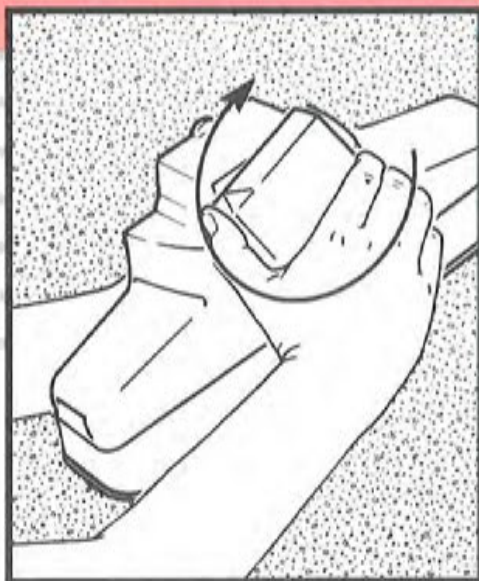

ADJUSTING THE BRUSH ROLL FOR OPTIMUM PERFORMANCE (cont)

3 Release the belt tension by turning the Belt Lifter (20) all the way to the right (clockwise) until the green arrows line up.

Unlock two latches on the rear of the Power Nozzle to remove the Rug Plate (26).

Then lift the brush out of the nozzle. ➤



4 Rotate the brush ends to Roman Numeral II (or III if appropriate). ➤

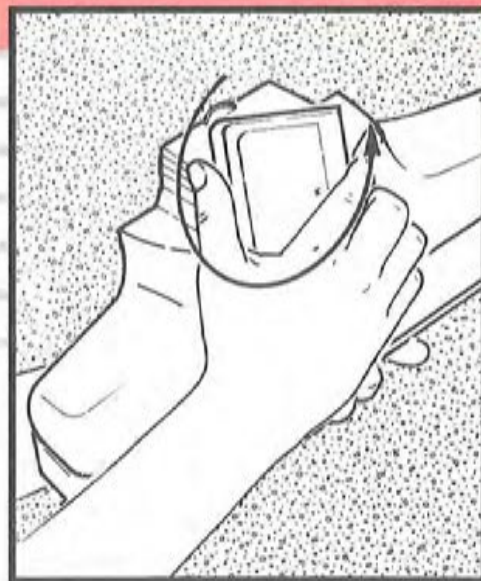

5 Place the brush back into the nozzle.

Replace the Rug Plate and lock into place with the two latches on the rear of the Power Nozzle.

Hook the belt onto the Belt Lifter and turn the Belt Lifter to the left (counter-clockwise) until the red arrows line up. This will stretch the belt in preparation for returning the nozzle to the Kirby (See Page 54 for additional details.) ◻

OPERATING/MAINTENANCE TIPS

Questions and Answers

Q. WHAT IS A DOUBLE-INSULATED MACHINE? (Servicing of double-insulated appliances)

A. In a double-insulated appliance, two systems of insulation are provided instead of grounding. No grounding means is necessary on a double-insulated appliance, nor should a means for grounding be added to the appliance. A double-insulated appliance is marked with the words "DOUBLE-INSULATED". The symbol  (square within a square) may also be marked on the appliance.

Servicing a double-insulated appliance requires extreme care and knowledge of the system, and should be done only by qualified service personnel. Replacement parts for this double-insulated Kirby Generation 3 model must be genuine Kirby parts for maintenance of safety and protection of warranty.

Q. WHAT SHOULD I DO IF THE MOTOR DOES NOT RUN WHEN I TURN THE KIRBY ON?

A. Many service calls are unnecessary. Checking a few simple things can save a lot of cost, time and trouble. Whenever your Kirby does not perform properly, make these checks first before calling authorized service personnel.

IF THE MOTOR DOES NOT RUN WHEN THE MOTOR ON-OFF SWITCH IS PUSHED:

1. Make sure the Power Cord is plugged

into an outlet and that the outlet has power. (Check for a blown fuse, tripped circuit breaker or power company trouble.)

2. Make sure the cord plug is fully inserted into the Kirby.

3. Look for breaks in the Power Cord insulation. If the cord is damaged, get a new one. **DO NOT ATTEMPT TO REPAIR IT.** Use only a genuine Kirby Power Cord. Do not use standard extension cords.

4. Make sure that an attachment or accessory is properly mounted on the front of the Power Plant. The Kirby will not run without the Power Nozzle (25), Hose Coupling, Air Intake Guard (19) or Accessory Brush Nozzle in place.

5. The Kirby will not run with the Bag/Mini Em-Tor (6), Hose Coupling or Carpet Shampoo Tank removed from the Air Exhaust Port (19).

Q. WHAT SHOULD I DO IF THE KIRBY DOES NOT PICK UP LINT OR LITTER ON THE CARPET:

A. 1. Check to see if Brush Roll Indicator Light (7) is lit when the Kirby is running.

2. If the Brush Roll Indicator Light continuously flickers or fails to light, the belt is slipping, broken or not on the motor pulley (23).

3. If the belt is not on the pulley (23), remove the nozzle and follow the in-

structions on Pages 11 and 54. See Page 56 for bristle extension.

4. If the belt is in good condition and the brush is running, see Page 55 for bristle wear.

5. Make sure that the nozzle height is adjusted to place the brush in contact with the carpet. See Page 12.

6. Check the bag to see if it is full.

7. Check the fill tube (5) for clogging.

8. Make sure the nozzle is not set too low. Raise the Toe-Touch Control one or two notches.

Q. I SMELL BURNING RUBBER WHEN I USE MY KIRBY. WHAT SHOULD I DO?

A. 1. Check to see if the Brush Roll Indicator Light (7) is lit brightly. The Brush Roll may be stalled due to threads around the ends.

2. Remove brush and make sure it rotates freely at both ends.

3. The nozzle may be adjusted too close to the carpet. Raise it one or two notches with the Toe-Touch Control bottom pedal (9).

KIRBY CLEANING PRODUCTS

Other fine Kirby Products and Supplies

Carpet Shampoo

Highly effective carpet/upholstery shampoo. Contains Kirby Guard anti-soiling agent and fabric brightener to keep carpets and upholstery looking like new. Has a pH of 9 for color-fast carpets. Available in 12 oz., 32 oz., 1 gallon, and 5 gallons.

Shampoo Pre-treatment

Specially formulated for pre-treating oil and grease-stained areas prior to shampooing—12 oz. spray bottle.

Scuttle 3

Versatile cleaner for a wide variety of hard surfaces including countertops, appliances, tile and more. Ideal for general-purpose cleaning all around the house. Available in 22 oz. container.

Glass Cleaner

Glass, mirror and window cleaner with the added power of ammonia. Just spray it on and wipe it off! Cleans and polishes glass and other washable hard surfaces in one easy step—22 oz. trigger spray bottle.

Spot Remover

Efficient stain remover designed for protein-based food stains. Simply “spot,” then “blot”—it’s that easy! 12 oz.

Home Freshener

Fast-working powdered room freshener. Sprinkle on carpets and vacuum in seconds. The delightful lemon scent lasts all day.

Odorific II

All-purpose deodorizer eliminates household odors. One drop lasts up to 24 hours!

KIRBY CLEANING PRODUCTS

Other fine Kirby Products and Supplies

Hand Soap

Liquid hand soap with soothing lanolin. Handy 8 oz. pump dispenser is perfect for bathroom or kitchen.

Liquid Scour

Multi-purpose bathroom and kitchen cleanser with non-abrasive micro-scrubbers. Easily cleans water deposits, soap scum, scale and other common soils without damaging fiberglass or plastics. 16 oz.

Disposable Filter Bags

Get the most out of your Generation 3 with genuine Kirby disposable filter bags. Available in handy three and nine packs.

Replacement Belts

Maintain peak efficiency with Generation 3 replacement belts from Kirby. Available in handy three packs for use with the Power Nozzle, Carpet Shampoo Nozzle and Floor Care Nozzle.

Vaculette

This light-weight, cord operated 120V-60Hz portable hand vacuum is perfect for cleaning stairs or tight spots that are hard to reach with your Generation 3.

Split Second

This cordless portable hand vacuum can be used where cord-type cleaners cannot reach. Comes complete with handy re-charging unit so it's always ready for use.

Split Second II

The twelve-volt automotive version of the popular Split Second portable hand vacuum plugs into a standard cigarette lighter. Perfect for cars, boats, campers and recreational vehicles.

INDEX

- A**
About this Manual 4
Accessories 33
Accessory Lock 21
Air Intake Guard 26
Attaching Bar 20
Attachments 19
 Attachment Hose 20
 Crevice Tool 23
 Duster Brush 22
 Extension Tubes 22
 Inflator/Deflator 27
 Massage Cup 24
 Suction Control Grip 24
 Upholstery Nozzle 23
 Wall & Ceiling Brush 23
- B**
Bag
 Assembly - removal 26
 Bag Release Button 17
 Bag Support Strap 10
 Changing bags 9
 Disposable Filter Bags 9
 Outer Cloth Bag 9
 Top Adapter 9
Belts
 Changing Belts 52
 Replacement Belts 58
Belt Lifter 11
Blower
 set-up 25
 using 27
Brush Roll
 adjusting for
 optimum performance 55
 Indicator Light 12
 I, II, III adjustment 55
- C**
Canister Cleaner 19
Carpet Fluffer 46
Carpet Shampoo System 34
 Belt Lifter 34
 cleaning 38
 replacing the belt 41
 set-up 34
 Suds Control Valve 36
 tray 34
 using 37
Carrying your machine 6
Cleaning products 58
Crevice Tool 23
- D**
Disposable Filter Bags 9, 58
Duster Brush 22
- E**
Extension Tubes 22
- F**
Floor Polisher 42
 Belt 42
 set-up 42
 using 45
- G**
Getting Started 5
- H**
Handle
 Attaching Portable Handle 17
 Handle Tilt Latch 6
 Handle Release Button 17
 removing Upright Handle 17
Hard Floor Pad 16
- I**
Indicator Light - Brush Roll 12
Inflator/Deflator Tool 27
- K**
Kirby Instant Suds 31, 36
- M**
Maintenance tips 51
Massage Cup 24
Mattress cleaning 18
Mini Em-Tor - emptying 10
Moving your machine 6
- O**
Operating Tips 51
Optional Accessories 33
Owner's Manual - using 4
- P**
Portable Cleaner 17
Portable Handle 17
Portable Shampooer
 set-up 31
 using 32
Portable Sprayer
 adjusting spray 29
 cleaning 30
 Dip Tube 30
 Jar 28, 31
 reassemble 30
 set-up 28
 Spray Opening 30
 using 29
Power Nozzle
 changing the belt 52
 disengaging brush roll 14
- height setting 12
lowering 7
raising 7
re-attaching 54
removal 20
Rug Plate 52
Brush Roll 52
Power Switch 12
- Q**
Questions & Answers 57
- R**
Replacement Belts 58
- S**
Safety Instructions 2
Straight Suction Cleaning 16
Suction Control Grip 24
Surface Nozzle 22
- T**
Table of Contents 3
TechDrive
 description 8
 ON/OFF Pedal 8
 Turning off 8
 Turning on 8
Tilt Latch 7
Toe-Touch Control 7
Turbo Accessory Kit 47
 Clamp Levers 47
 Dust Shroud 47
 massage 49
 polishing 49
 Rear Clamp 48
 sanding 47
 scouring 49
 set-up 47
- U**
Upholstery Nozzle 23
Upright Cleaner 14
Upright Handle - removing 17
- Z**
Zippbrush
 Turbine 50
 cleaning 50
 Outer Brush Ring 50
 using 50

