



Contents

Caution	1
Specifications	2
Dimensional Drawing	3
Components/Setup	4
Operation/Reset Procedure	5
Troubleshooting	6



Ensure no obstacles are in the column's path. Ensure the columns are not touching any walls. Ensure all cords are appropriate length to accommodate the change in height.



Warning
Pinch Point
Keep hands and fingers clear.



Keep children away from electric height-adjustable lifting columns, control units, and handsets. There is a risk of injury and electric shock.



Keep all electrical components away from liquids.



Do not sit or stand on the lifting columns. Do not crawl or lie under the lifting columns.



Do not place any objects taller than 20" underneath the lifting columns.



During the Reset Procedure, the columns will retract **7mm below the lowest normal operating height**, ensure no obstacles impede this motion of travel.

Input Voltage	120 VAC, 60 Hz
Output Voltage	24 VDC
Stroke*	16"
Weight Capacity	2600lbs (1300lbs Per Column)
Speed	0.24"/sec
Height Range	22.8" - 37.9"
Duty Cycle	10% Max. (2 mins on, 18 mins off)
Material	Aluminum Alloy
Certification	UL
IP Rating	IP43

Feature	Description
Soft Start and Stop	The tablelift will accelerate to maximum speed and decelerate to a stop to ensure smooth travel.
Memory Presets	The Smart Remote has the ability to save preset height locations for convenience. Set the numbered buttons on the Smart Remote for quick and seamless adjustment.

*When using the FLT-12 with the included control box, the stroke size will be 15" due to the safety feature built into the control box.

Dimensional Drawing

Legs

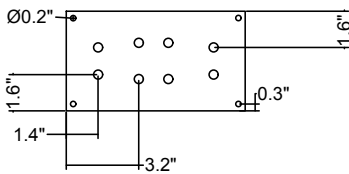
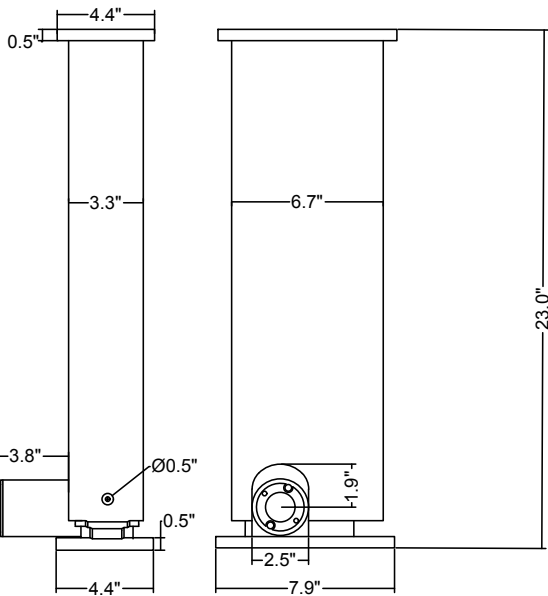
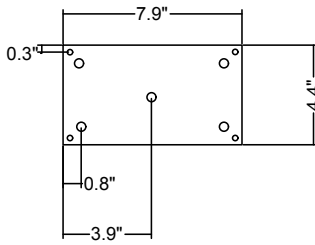

Remote

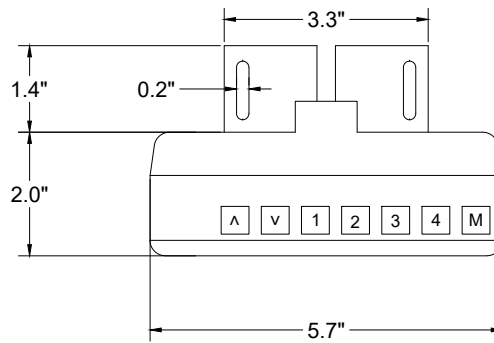

Control Box

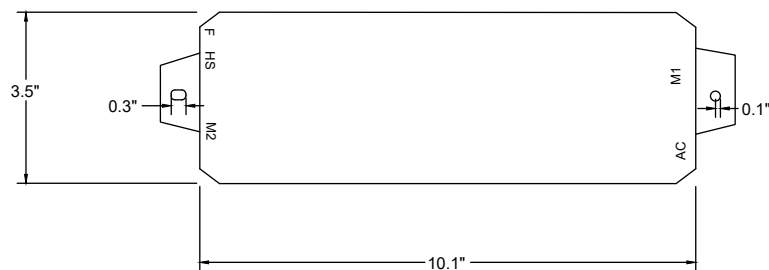
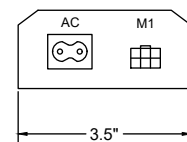
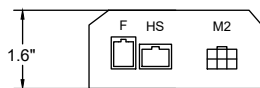

Components

Lifting Columns x 2



Control Box and Remote



AC Power Cord



Setup

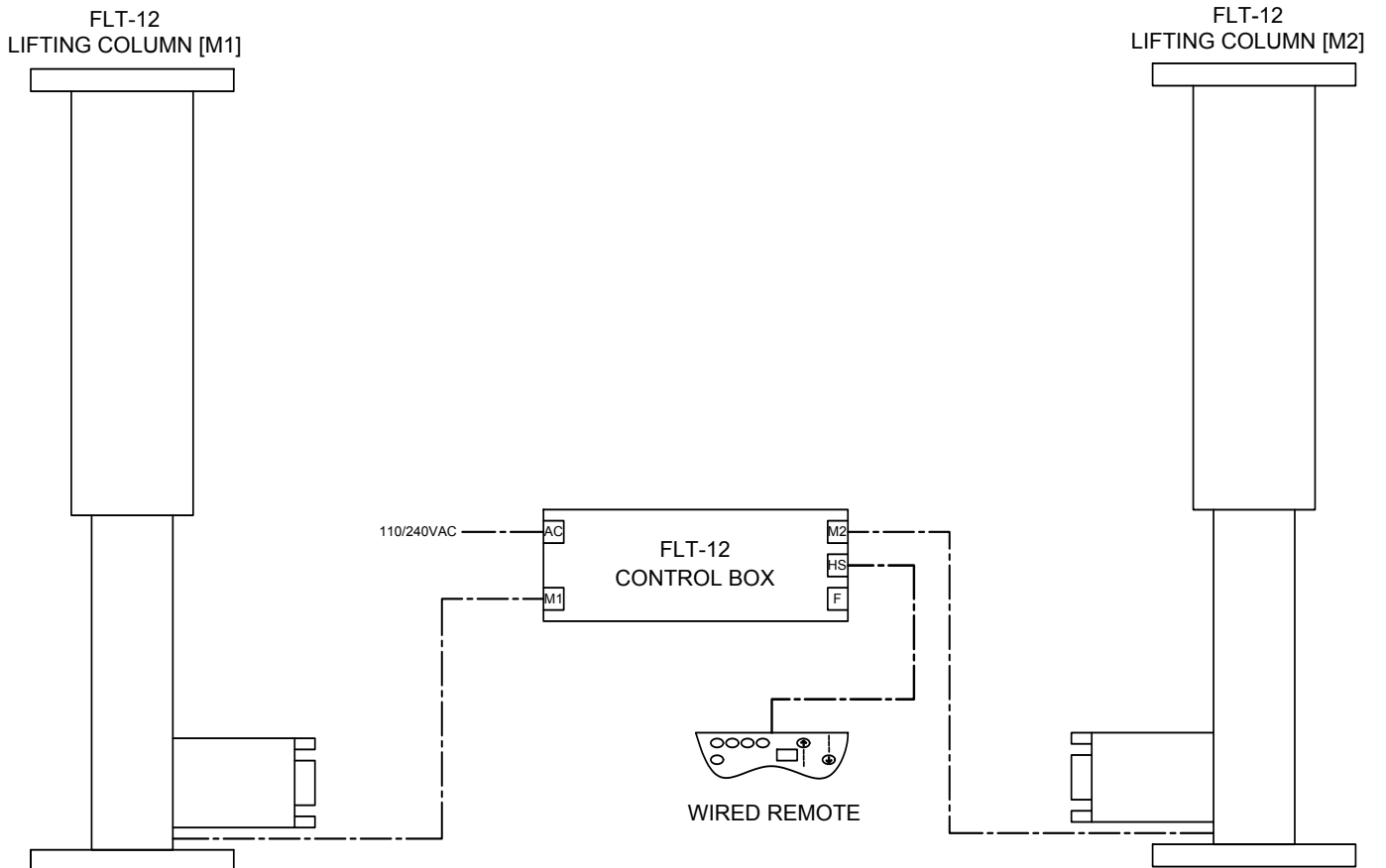

Normal Operation

Using the wired remote, press and hold the 'Up' button to raise the table lift. To lower the table lift, press and hold the 'Down' button. The 'Up' and 'Down' buttons are momentary controlled, when they are released, the table lift will stop immediately.

To set a preset location, move the table lift to the desired height. Press the 'M' button followed by a numbered button. The LED display will flash an 'S', followed by an 'S - Number'. This will indicate that the preset has been saved.

To use a preset, press any of the numbered buttons and the table lift will begin to move to the preset position. It is important to ensure that no obstacles impede the motion of travel. To stop the table lift, press any button.

If the table lift does not function as intended or the LED display flashes "RSt", please follow the Reset Procedure outlined in the next section.

Setting the LED Display

Using the wired smart remote, retract the table lift to the lowest position. Press and hold the 'Down' button again until the LED display flashes "RST".

Press and hold the 'M' button until the LED display flashes the starting height (if the display returns to "RSt" before the next step, repeat this step).

To change the value of the starting height, use the 'Up', 'Down' to increase and decrease by 0.1. Use the '1', '2' to increase and decrease by 1s. Use the '3', and '4' buttons to increase or decrease by 10s.

Once the correct value is displayed, wait 5 seconds until the LED display flashes "RSt". Follow the Reset Procedure outlined in the next section to save the new starting height.

Note: the LED display has a tolerance of ± 0.1 .

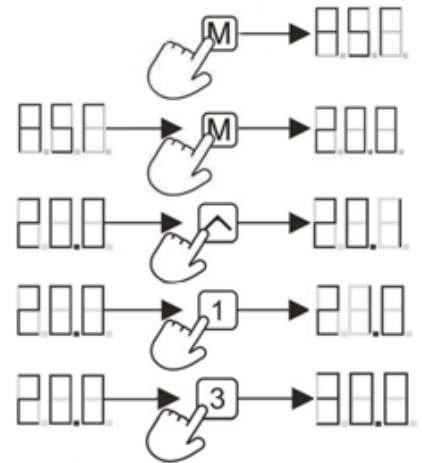

Reset Procedure

WARNING: During the Reset Procedure, the table lift will retract 7mm below the lowest normal operating height, please ensure that no obstacles impede this motion of travel.

1. Move the table lift to the lowest position. (If there is an 'RSt' displayed on the remote, continue to step 3.)

2. To initiate the Reset Procedure, press and hold the down button on the remote until "ASr" is displayed. Release the down button.

3. Press and hold the down button on the remote, the table lift will begin to retract 7mm lower than the lowest normal operating height. To stop motion at any time, let go of the down button.

4. Once the table lift has completed the Reset Procedure, height will be displayed on the remote.

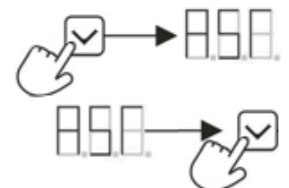

Troubleshooting Guide		
Problem	Possible Cause	Corrective Action
Remote LED is off.	Low power mode activated	Press any button on the remote and LED will activate.
	Connection issue	Disconnect and reconnect the RJ-45 remote connector. Ensure connection is secure and cable is not damaged.
Table lift does not move when motion control buttons are pressed.	Limit switch reached	Follow "Setting Limit Switches" instructions to remove the programmed limit. If maximum or minimum height limit has been reached, please move the system in the opposite direction.
	Connection issue	Disconnect and reconnect the Lifting Columns, Control Box, AC Power, and Remote.
Table lift travels at a significantly slower speed than rated specification.	Weight issue	Ensure weight capacity has not exceeded the maximum load rating.
Unusual noise during travel.	Weight issue	Ensure weight capacity has not exceeded the maximum load rating.
Table lift stops abruptly during travel.	Obstacle	Ensure there are no obstacles in the path of the table lift. If the movement continues to fail, initiate the Reset Procedure.
Table lift is not level.	Out of sync	Disconnect and reconnect all cables (Lifting Column, Control Box, AC Power, and Remote), then initiate the Reset Procedure.

Error Codes (remotes with LED display)		
Error Code	Error Summary	Description
E01	M1 overcurrent protection	All columns stop moving and remote displays E01-E04. Ensure that the total weight capacity of the table lift has not been exceeded and that no obstacles obstruct the movement. Press any key and remote will display RST, initiate the Reset Procedure. If the issue persists, disconnect and reconnect all of the lifting columns, including the main power. Repeat the Reset Procedure.
E02	M2 overcurrent protection	
E03	M3 overcurrent protection	
E04	M4 overcurrent protection	
E07	M1 hall error	All columns stop moving and remote displays E07-E10. Ensure that all columns are still properly connected to the control box. Check to see if any cables have been damaged. Press any key and remote will display RST, initiate the Reset Procedure. If the issue persists, disconnect and reconnect all of the lifting columns, including the main power. Repeat the Reset Procedure.
E08	M2 hall error	
E09	M3 hall error	
E10	M4 hall error	
H01	Over heat /duty cycle protection	All columns stop moving, remote displays H01 (if LED screen available). Allow the system to rest for 16 minutes, use normally. Follow the Duty Cycle rating to ensure no issues arise from overheating.