

Hot Tubs

**200 Series, 2005 ProTech™
Owner's Manual**

Standard 240 VAC, 3-Wire Connector
USE COPPER CONDUCTORS ONLY.

Table of Contents

1.0	Important Spa Owner Information	1
2.0	FCC Notice	1
3.0	Important Safety Instructions	2
3.1	Important CSA Safety Information (Canada Only)	3
3.2	Hyperthermia	4
3.3	Cautions	5
3.4	General Electrical Safety Instructions	5
4.0	Choosing A Location	6
4.1	Outdoor Location	6
4.2	Indoor Location	7
5.0	Power Requirements	8
6.0	Electrical Wiring Instructions	10
7.0	Start-Up Instructions	12
7.1	Filling The Spa	12
7.2	Safety Check	13
7.3	Turn on Power	13
7.4	Initiate Water Circulation	13
7.5	Add Start-Up Chemicals	13
7.6	Place Cover on Spa	13
8.0	Control Functions	14
8.1	Control Panel	14
8.2	Spa Features And Controls	15
8.3	Jet/Air Controls Diagram (J-210 & J-220 Models)	16
8.4	Jet/Air Controls Diagram (J-230 Models)	17
9.0	Operating Instructions	18
9.1	Setting Water Temperature	18
9.2	Activate Pumps	18
9.3	Light Button	18
9.4	Selecting Desired Massage Action	18
9.5	Adjusting Individual Jet Flow	19
9.6	Air Controls	19

10.0 Automatic Filtration Cycles	20
10.1 Standard Filtration/Heating Modes (F1 - F3).....	20
10.2 Economy Filtration/Heating Modes (F4 - F6)	20
10.3 Lock Modes (L1 - L2).....	20
10.4 Selecting The Skimming/Heating Mode.....	20
11.0 Spa Maintenance	22
11.1 Cleaning The Filter	22
11.2 Draining and Refilling.....	22
11.3 Cleaning The Spa Interior.....	23
11.4 Pillow Care.....	23
11.5 Maintaining The Cover.....	23
11.6 Maintaining The Optional Synthetic Cabinet	24
11.8 Winterizing	24
11.9 Restarting Your Spa in Cold Weather.....	25
12.0 Water Quality Maintenance	25
12.1 pH Control.....	25
12.2 Sanitizing	26
12.3 Optional CD Ozone Water Maintenance System	26
13.0 Error Conditions/Error Messages	26
13.1 Panel Displays SN1	26
13.2 Panel Displays SN2	26
13.3 Panel Displays FL1	26
13.4 Panel Displays FL2.....	27
13.5 Panel Displays COL.....	27
13.6 Panel Displays ICE	27
13.5 Panel Displays OH.....	27
13.8 Panel Displays - - - -	27
14.0 Troubleshooting Procedures	27
14.1 None of The Components Operate	28
14.2 Pump Does Not Operate but Light Does.....	28
14.3 Poor Jet Action.....	28
14.4 Water is Too Hot	28
14.5 No Heat.....	28
15.0 J-210/J-220 Convertible Circuit Diagram (60Hz).....	30
16.0 J-230 Circuit Diagram (60Hz).....	31
17.0 J-210/J-220 Circuit Diagram (50Hz).....	32
18.0 J-230 Circuit Diagram (50Hz).....	33



1.0 Important Spa Owner Information

Your Jacuzzi® 200 series spa is constructed to the highest standards and is capable of providing many years of trouble-free use. However, because heat retentive materials are utilized to insulate the spa for efficient operation, an uncovered spa surface directly exposed to sunlight and high temperatures for an extended period is subject to permanent damage. Damage caused by exposing the spa to this abuse is not covered by warranty. We recommend that you always keep the spa full of water when it is exposed to direct sunlight and that you keep the Jacuzzi Premium insulating cover in place at all times when the spa is not in use. Read and carefully follow the requirements for your spa's support base found in section 4.0 titled, "Choosing a Location" (Page 6).

Jacuzzi constantly strives to offer the finest spas available, therefore modifications and enhancements may be made which affect the specifications, illustrations and/or instructions contained herein.

2.0 FCC Notice



This equipment has been tested and found to comply with the limits for a Class B Digital Device, pursuant to Part 15 of the FCC Rules. These limits are designed to provide reasonable protection against harmful interference in a residential installation. This equipment generates, uses and can radiate radio frequency energy and, if not installed and used in accordance with the instructions, may cause harmful interference to radio communications. However, there is no guarantee that interference will not occur in a particular installation. If this equipment does cause harmful interference to radio or television reception, which can be determined by turning the equipment off and on, the user is encouraged to try to correct the interference by one or more of the following measures:

1. Rearrange or relocate the receiving antenna.
2. Increase the separation between the equipment and receiver
3. Connect the equipment into an outlet on a circuit different from the circuit connected.
4. Consult the dealer or an experienced radio/TV technician for help.

Changes or modifications not expressly approved by the party responsible for FCC compliance could void the user's authority to operate this equipment.



3.0 Important Safety Instructions



When installing and using this electrical equipment, basic safety precautions should always be followed, including:

1. READ AND FOLLOW ALL INSTRUCTIONS BEFORE OPERATING THE SPA!
2. WARNING: To reduce the risk of injury, do not permit children to use this product unless they are closely supervised at all times.
3. WARNING: A grounding wire connector is provided on this unit to connect a minimum No. 8 AWG (8.4mm²) solid copper conductor between this unit and any metal equipment, metal enclosures of electrical equipment, metal water pipe, or conduit within 5 feet (1.5m) of the unit.
4. DANGER: *Risk of Accidental Drowning*. Extreme caution must be exercised to prevent unauthorized access by children. To avoid accidents, ensure that children cannot use this spa unless they are supervised at all times.
5. DANGER: *Risk of Injury*. The suction fittings in this spa are sized to match the specific water flow created by the pump. Should the need arise to replace the suction fittings or the pump, be sure that the flow rates are compatible. Never operate the spa if the suction fittings are broken or missing. Never replace a suction fitting with one rated less than the flow rate marked on the original suction fitting.
6. DANGER: *Risk of Electric Shock*. Install at least 5 feet (1.5m) from all metal surfaces. As an alternative, a spa may be installed within 5 feet (1.5m) of metal surfaces if each metal surface is permanently connected (bonded) by a minimum No. 8 AWG (8.4mm²) solid copper conductor attached to the wire connector on the grounding lug, inside the equipment compartment on the equipment box.
7. DANGER: *Risk of Electric Shock*. Do not permit any electrical appliance, such as a light, telephone, radio, television, etc. within 5 feet (1.5m) of a spa, unless such appliances are built-in by the manufacturer.
8. ELECTRICAL SUPPLY: The electrical supply for this product must include a suitably rated switch or circuit breaker to open all ungrounded supply conductors to comply with section 422-20 of the National Electrical Code, ANSI/NFPA 70. The disconnect must be readily accessible and visible to the spa occupant but installed at least 5 feet (1.5m) from the spa water.
9. WARNING: To Reduce the Risk of Injury:
 - A. The water in a spa should never exceed 104 °F (40 °C). Water temperatures between 100 °F (38 °C) and 104 °F (40°C) are considered safe for a healthy adult. Lower water temperatures are recommended



- for young children and when spa use exceeds 10 minutes.
- B. Since excessive water temperatures have a high potential for causing fetal damage during the early months of pregnancy, pregnant or possibly pregnant women should limit spa water temperatures to 100 °F (38 °C). If pregnant, please consult your physician before using a spa.
 - C. Before entering the spa, the user should measure the water temperature with an accurate thermometer since the tolerance of water temperature-regulating devices may vary as much as +/- 5 °F (2 °C).
 - D. The use of alcohol, drugs, or medication before or during spa use may lead to unconsciousness with the possibility of drowning. Persons using medication should consult a physician before using a spa since some medication may induce drowsiness, while other medication may affect heart rate, blood pressure, and circulation.
 - E. Persons suffering from obesity or a medical history of heart disease, low or high blood pressure, circulatory system problems, or diabetes should consult a physician before using a spa.

3.1 IMPORTANT CSA SAFETY INSTRUCTIONS (CANADA ONLY)



When using this electrical equipment, basic safety precautions should always be followed, including the following:

1. READ AND FOLLOW ALL INSTRUCTIONS.
2. A green colored terminal or a terminal marked G, Gr, Ground, Grounding or the \oplus symbol* is located inside the supply terminal box or compartment. To reduce the risk of electric shock, this terminal must be connected to the grounding means provided in the electric supply service panel with a continuous copper wire equivalent in size to the circuit conductors that supply this equipment (*IEC Publication 417, Symbol 5019).
3. At least two lugs marked "Bonding Lugs" are provided on the external surface or on the inside of the supply terminal box/compartment. To reduce the risk of electric shock, connect the local common bonding grid in the area of the spa to these terminals with an insulated or bare copper conductor not smaller than No. 6 AWG (10mm²).
4. All field-installed metal components such as rails, ladders, drains or other similar hardware within 10 feet (3m) of the spa shall be bonded to the equipment grounding buss with copper conductors not smaller than No. 6 AWG (10mm²).
5. Save These Instructions:
 - A. **WARNING:** Children should not use spas without adult supervision.



- B. WARNING: Do not use spas unless all suction guards are installed to prevent body and hair entrapment.
- C. WARNING: People with infectious diseases should not use a spa.
- D. WARNING: To avoid injury, exercise care when entering or exiting the spa.
- E. WARNING: Do not use drugs or alcohol before or during the use of a spa to avoid unconsciousness and possible drowning.
- F. WARNING: Pregnant or possibly pregnant women should consult a physician before using a spa.
- G. WARNING: Water temperature in excess of 38 °C (104 °F) may be injurious to your health.
- H. WARNING: Before entering the spa, measure the water temperature with an accurate thermometer.
- I. WARNING: Do not use a spa immediately following strenuous exercise.
- J. WARNING: Prolonged immersion in a spa may be injurious to your health.
- K. WARNING: Do not permit electric appliances (such as light, telephone, radio, television, etc.) within 5 feet (1.5m) of this spa unless factory installed.
- L. CAUTION: Maintain water chemistry in accordance with manufacturer's instructions.
- M. WARNING: The use of alcohol or drugs can greatly increase the risk of fatal hyperthermia in spas.

3.2 HYPERTHERMIA

Prolonged immersion in hot water may induce hyperthermia. A description of the causes, symptoms, and effects of hyperthermia are as follows:

Hyperthermia occurs when the internal temperature of the body reaches a level several degrees above the normal body temperature of 98.6 °F (37 °C). The symptoms of hyperthermia include drowsiness, lethargy, and an increase in the internal temperature of the body. The effects of hyperthermia include:

- A. Unawareness of impending hazard;
- B. Failure to perceive heat;
- C. Failure to recognize the need to exit spa;
- D. Physical inability to exit spa;
- E. Fetal damage in pregnant women; and
- F. Unconsciousness and danger of drowning.



3.3 CAUTIONS

1. Persons suffering from heart disease, diabetes, high or low blood pressure, and any condition requiring medical treatment, pregnant women, the elderly, or infants should consult with a physician before using a spa.
2. The Consumer Products Safety Commission has stated that the water temperature in a spa should not exceed 104 °F (40 °C). Immersion in water in excess of 104 °F (40 °C) can be hazardous to your health.
3. Observe a reasonable time limit when using the spa. Long exposures at higher temperatures can cause high body temperature. Symptoms may include dizziness, nausea, fainting, drowsiness, and reduced awareness. These effects could possibly result in drowning.
4. Do not use the spa under the influence of alcohol, narcotics, or other drugs. Use of the spa under these conditions may lead to serious consequences.
5. Always test the spa water temperature before entering the spa. Enter and exit the spa slowly. Wet surfaces can be very slippery.
6. Never bring any electrical appliances into or near the spa. Never operate any electrical appliances from inside the spa or when you are wet unless such appliances are built-in by the manufacturer.
7. Proper chemical maintenance of spa water is necessary to maintain safe water and prevent possible damage to spa components.
8. Use the straps and clip tie downs to secure the cover when not in use. This will help to discourage unsupervised children from entering the spa and keep the spa cover secure in high-wind conditions. There is no representation that the cover, clip tie-downs, or actual locks will prevent access to the spa.

3.4 GENERAL ELECTRICAL SAFETY INSTRUCTIONS

Your new Jacuzzi spa is equipped with a “state-of-the-art” equipment system. It contains the most advanced safety and self-protective equipment in the industry. Nonetheless, this spa must be installed properly to insure dependable usage. Please contact your dealer or local building department should you have any questions regarding your installation.

Proper grounding is extremely important. Jacuzzi spas are equipped with a current collector system. A pressure wire connector is provided on the surface of the control box, located outside the equipment door (Figure B, Page 11) to permit connection of a bonding wire between this point and any ground metal equipment, metal water pipe or conduit within 5 feet (1.5m) of the spa, or copper clad grounding rod buried within 5 feet (1.5m) of the spa. Bonding wire must be at least No. 8 AWG (8.4mm²)



solid copper wire. This is a most important safety assurance feature. Before installing this spa, check with the local building department to insure installation conforms to local building codes.

120/240 Volt Convertible Models

A spa connected to a 120 VAC electrical service must be located close enough to a grounded, grounding-type electrical outlet so that the included power cord can be plugged directly into it. **DO NOT USE AN EXTENSION CORD** as this could cause damage to the spa's equipment due to insufficient voltage. The power supplied to this spa must be a dedicated circuit with no other appliances or lights sharing the power provided by the circuit.

4.0 Choosing A Location



IMPORTANT: Because of the combined weight of the spa, water and users, it is extremely important that the base upon which the spa rests be smooth, flat, level and capable of uniformly supporting this weight, without shifting or settling, for the entire time the spa is in place. If the spa is placed on a surface which does not meet these requirements, damage to the skirt and/or the spa shell may result. Damage caused by improper support is not covered under warranty. It is the responsibility of the spa owner to assure the integrity of the support over time.

We recommend a poured, reinforced concrete slab with a minimum thickness of 4 inches (10cm). Wood decking is also acceptable provided it is constructed so that it meets the requirements outlined above. The spa must be installed in such a manner as to provide drainage away from the spa. Placing the spa in a depression without provisions for proper drainage could allow rain, overflow and other casual water to flood the equipment and create a wet condition in which it would sit. For spas which will be recessed into a floor or deck, install so as to permit access to the equipment, either from above or below, for servicing. Make certain that there are no obstructions which would prevent removal of the cabinet side panels and access to the jets components, especially on the side with the equipment bay doors.

4.1 Outdoor Location

In selecting the ideal outdoor location for your spa, we suggest that you take into consideration:

1. The proximity to changing area and shelter (especially in colderweather).



2. The pathway to and from your spa (this should be free of debris so that dirt and leaves are not easily tracked into the spa).
3. The closeness to trees and shrubbery (remember that leaves and birds could create extra work in keeping the spa clean).
4. A sheltered environment (less wind and weather exposure can result in lowered operation and maintenance costs).
5. The overall enhancement of your environment. It is preferable not to place the spa under an unguttered roof overhang since run-off water will shorten the life expectancy of the spa cover.

4.2 Indoor Location

For indoor installations, be certain to make provisions for proper ventilation. When the spa is in use, considerable amounts of moisture will escape. This can damage certain surfaces over time. If you have any questions regarding the placement or installation of your spa, consult your authorized Jacuzzi Dealer.



5.0 Power Requirements

Jacuzzi spas are designed to provide optimum performance and flexibility of use when connected to the maximum electrical service listed in the tables below. If you prefer, your dealer can perform a minor circuit board modification to allow your spa to accept an electrical service other than the factory setting.

US / Canada J-210 / J-220 1-Pump Convertible Model (60Hz)

	<u>120V/15A*</u>	<u>240V/30A**</u>	<u>240V/40A***</u>
Voltage:	120 VAC	240 VAC	240 VAC
# of Wires:	3 (15A GFCI Cord, US only*)	4	4
Frequency:	60Hz	60Hz	60Hz
Current Draw:	12A	21A	30A
Circuit Breaker:	15A, 1-Pole	30A, 2-Pole	40A, 2-Pole

For 240 VAC Heater Operation: Move the red wire on the main terminal strip (TB1) from position #1 to position #3. Make certain wires are connected exactly as shown in Figure-D (Page 12) before applying power. Failure to do so will result in damage to the circuit board and/or related components and void the manufacturer's warranty.

* **All Canadian spas must be hard wired (120 VAC or 240 VAC) per CSA Canadian standards.**

** In the 15A/30A configuration, the heater **will not operate** at the same time as the high-speed jets pump. **The factory setting is 120V/15A.**

*** If the spa is to be operated on 40A service, remove the jumper JP1 #1-2 on the circuit board to allow the heater to operate at the same time as the high-speed jets pump (Page 30).



US / Canada J-230 2-Pump Model (60Hz)

	<u>240V/50A*</u>	<u>240V/35A**</u>
Voltage:	240 VAC	240 VAC
# of Wires:	3	3
Frequency:	60Hz	60Hz
Current Draw:	36A	26A
Circuit Breaker:	50A, 2-Pole	35A, 2-Pole

* In 50A configuration, the heater **will not operate** while both jets pumps are running in high speed. *Note: pump 2 runs only in high speed.*
This is the factory setting.

** In 35A configuration, the heater **will not operate** while either jets pump is running in high speed. *Note: pump 2 runs only in high speed.*

Export J-210 / J-220 1-Pump Models (50Hz)

	<u>230V/20A*</u>	<u>230V/30A**</u>
Voltage:	230 VAC	230 VAC
# of Wires:	3	3
Frequency:	50Hz	50Hz
Current Draw:	15A	21A
Circuit Breaker:	20A	30A

* In the 20A configuration, the heater **will not operate** while either jets pump is running in high speed.. **This is the factory setting.**

** In the 30A configuration, the heater **will operate** with one pump running at high speed.

Export J-230 2-Pump Model (50Hz)

	<u>230V/20A*</u>	<u>230V/30A**</u>
Voltage:	230 VAC	230 VAC
# of Wires:	3	3
Frequency:	50Hz	50Hz
Current Draw:	15A	23A
Circuit Breaker:	20A	30A

* In 20A configuration, the heater **will not operate** while either jets pump is running in high speed. **This is the factory setting.** *Note: pump 2 runs only in high speed.*



6.0 Electrical Wiring Instructions

IMPORTANT NOTICE: The electrical wiring of this spa must meet the requirements of the National Electrical Code (NEC) and any applicable state or local codes. The electrical circuit must be installed by a qualified electrician and approved by a local building/electrical inspection authority.



1. **Convertible 120/240V Power Models**
- A. **120V “Plug-in” Operation:** This spa must operate on the supplied 120V GFCI cord at its original length or must be hard-wired for longer runs. **Never use an extension cord for any reason!**
- B. **Convertible 120/240V Operation:** The included 120V GFCI cord must be discarded for 240V operation. This spa must be hard-wired. Supplying power to either configuration above which is not in accordance with these instructions will void both the independent \ testing agency listing and the manufacturer’s warranty.
2. **Dedicated 230-240V Power Models:** This spa must be permanently connected (hard-wired) to the power supply. **No plug-in connections or extension cords are to be used in conjunction with the operation of this spa.** Supplying power to the spa which is not in accordance with these instructions will void both the independent testing agency listing and the manufacturer’s warranty.
3. The power supplied to this spa *must* be a *dedicated* circuit with no other appliances or lights sharing the power provided by the circuit.
4. To determine the current, voltage and wire size required, refer to section 5.0 “Power Requirements” (Page 8-9).
 - Wire size must be appropriate per NEC and/or local codes.
 - We recommend type THHN wire.
 - All wiring must be copper to ensure proper connections. **Do not use aluminum wire.**
 - When using wire larger than #6 (10mm²), add a junction box near the spa and reduce to short lengths of #6 (10mm²) wire to connect to the spa.
5. The electrical supply for this product must include a suitably rated switch or circuit breaker to open all ungrounded supply conductors to comply with Section 422-20 of the National Electrical Code, ANSI/NFPA 70. The disconnecting means must be readily accessible to the spa’s occupant but installed at least 5 feet (1.5m) from spa water.
6. The electrical circuit supplied for the spa must include a suitable ground fault circuit interruptor (GFCI) as required by NEC Article 680-42.



- To gain access to the spa's power terminal block, remove the screws securing the cabinet panel on the side of the spa under the controls. Then remove the four control box door screws and door (Figure B,).
- Select the power supply inlet you want to use (Figure A). Feed power cable to control box, then install it through the large opening provided in the bottom side of the box.
- Connect wires, color to color, on terminal blocks TB1 and TB3 (Figures C-F, Page 12). TIGHTEN SECURELY! All wires must be hooked up securely or damage could result.
- Install control box door and screws and reinstall the cabinet side panels.

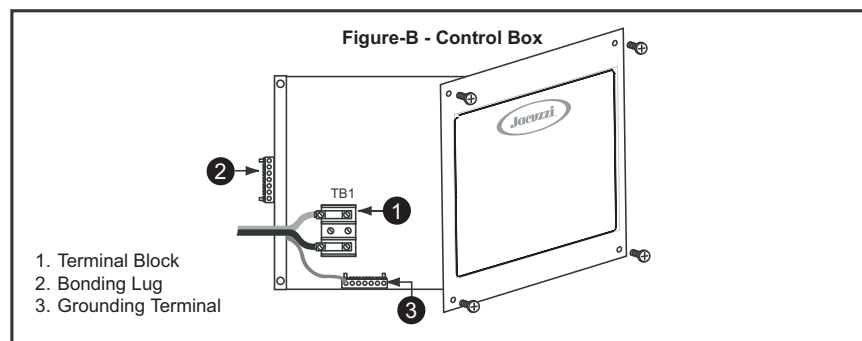
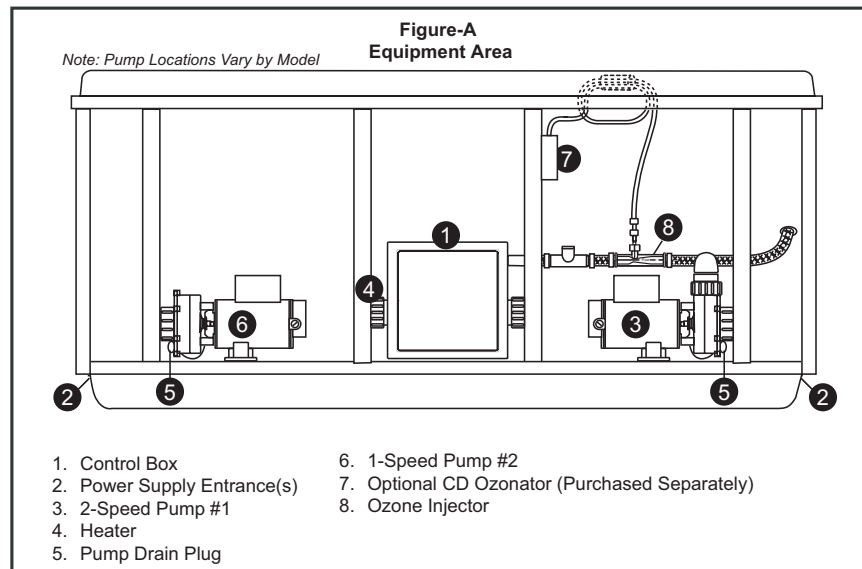

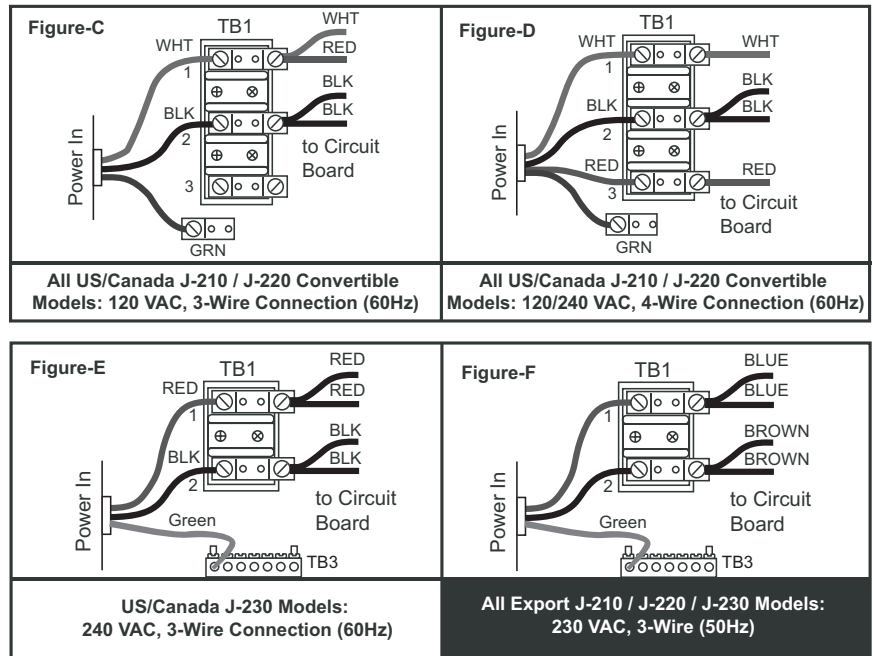

7.0 Start-Up Instructions

Congratulations! You are now all set to get your new spa ready to use. Simply follow this step-by-step procedure and, before long, you will be enjoying your first glorious experience in your Jacuzzi J-200 spa. For best results, read each step in its entirety before proceeding with that step.

7.1 Filling the Spa

Clear all debris from the spa. Although the spa shell has been polished at the factory, you may want to treat it with a specially formulated spa cleaner and wax available from your dealer prior to filling the first time.

Remove the filter cartridge as outlined in section 11.1 (Page 22). Place the end of your garden hose into the exposed pump #1 filter wall fitting, and fill the spa half way. Continue filling spa until the water level is 1 inch below the lowest pillow and above all jets. **Do not overfill.** Never fill with water from a water softener.

If your water is extremely "hard", it is preferable to fill half-way with hard water and the rest of the way with softened water. Or, you may fill entirely with hard water if you use a special water additive available from your



Jacuzzi dealer. Always refill spa half way through the filter wall fitting to purge trapped air from pump intake. Failure to do so may cause air to be trapped in pump 1, preventing pump from circulating water. After filling, make sure both filter is installed properly before applying power to the spa. Refer to section 11.1 (Page 22) “Cleaning the Filters” for specific cleaning and installation instructions.

7.2 Safety Check

Open the wood cabinet access panel and check all pump unions to make sure they are hand tight. Loosening can occur during shipping and handling.

7.3 Turn on Power

Turn on power to spa at the home’s circuit breaker. The heater and low speed pump 1 automatically activate and the control panel LED display flashes water temperature and “COL” or “ICE” (page 27).

7.4 Initiate Water Circulation

Depress the **JETS 1** sensor pad on the control panel twice to activate pump 1 in high speed and initiate maximum water flow to certain jets.

7.5 Add Start-Up Chemicals

Add the spa water chemicals as recommended by your Jacuzzi dealer. Refer to section 12.2 (page 26) for general guidance.

7.6 Place Cover On Spa

Keeping the insulating cover in place anytime the spa is not in use will reduce the time required for heating, thereby minimizing operating costs. The time required for initial heat-up will vary depending on the starting water temperature and the capacity of your spa. Smaller spas heat at a rate of approximately 8 to 10 degrees per hour (based on 240V operation); large spas heat at about 4 to 6 degrees per hour.



WARNING: RISK OF INJURY. Always check water temperature carefully before entering spa.



8.0 Control Functions

8.1 Control Panel

A. LED Display: can display current water temperature (default display), water temperature setpoint, selected skimming/heating mode, and error messages.

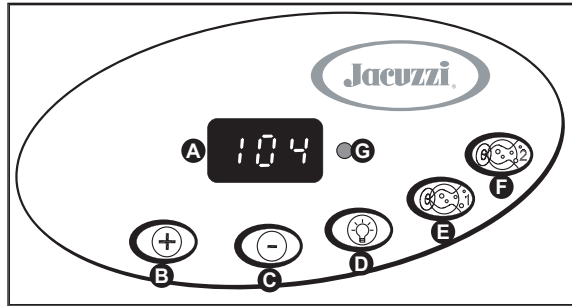

B. Warmer (+) Button: increases water temperature setpoint.

C. Cooler (-) Button: decreases water temperature setpoint.

D. Light Button: turns underwater light on and off.

E. Jets 1 Button: turns jets pump #1 on and off. Press once for low speed; press a second time for high speed; press a third time to turn pump off.

F. Jets 2 Button: turns high-speed jets pump #2 on and off. Press once to turn on; press a second time to turn pump off (2-pump models only).

G. Heat Indicator: lit when heater is on.

Operation Details

- Temperature Adjustment: 65 to 104 °F (18 to 40 °C). Factory default setting is 100 °F (38 °C).
- Underwater Light Operation: light runs for 1 hour then shuts off for increased bulb life.
- Jets 1/Jets 2 Button Operation: jets run for 20 minutes after activated, then turn off automatically to conserve energy. Simply press either jets button to continue operation for an additional 20 minutes.



8.2 Spa Features And Controls



J-230 model illustrated - Location of Features Varies by Model

- | | |
|--------------------------------|---|
| 1. Control Panel | 8. Vertical Jets (Foot Jets) |
| 2. Air Controls | 9. Footwell Suction Fittings and Filters. |
| 3. Filter/Skimmer | 10. Heater Return / Gravity Drain Fitting |
| 4. Therapy Jets | 11. Calf Jets (J-220 only) |
| 5. Diverter Valve (J-220 only) | |
| 6. Therapy Seat | |
| 7. Spa Light | |



8.3 Jet/Air Controls Diagram (J-210 & J-220 Models)

J-210
Massage Selector Operation
*Rotate Diverter Jet "1"
to Divert Water Between Jet
Groups A-B.*

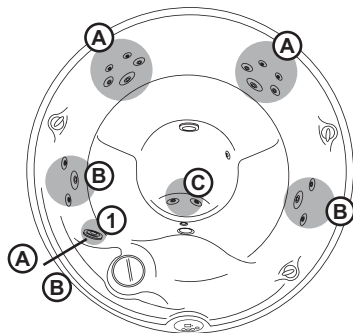

Continuously Powered Jets
Group C

Air Control Operation
*Depress Air Controls A-C to
Open or Close Air Inlet to
Designated Jet Groups.*

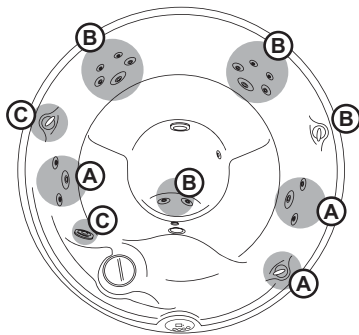

J-220
Massage Selector Operation
*Rotate Massage Selector 1 to
Divert Water Between Jet Groups
A or B&C.*

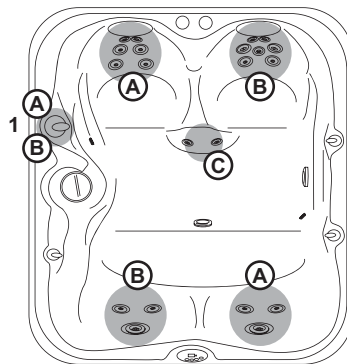

Continuously Powered Jets
Group C
*Massage Selector #1 Controls
the Main Pump's Water Flow.*

Air Control Operation
*Depress Air Controls A-C to
Open or Close Air Inlet to
Designated Jet Groups.*

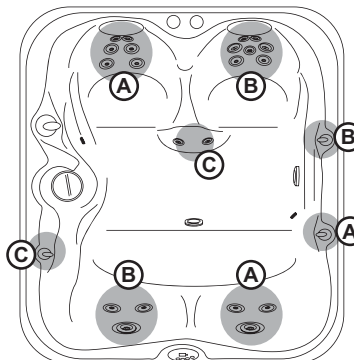



8.4 Jet/Air Controls Diagram (J-230 Models)

J-230 Massage Operation

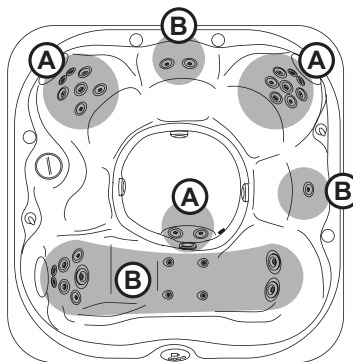

Massage Pump #1 (A)
Massage Pump #2 (B)

Air Control Operation
Depress Air Controls A or B to
Open or Close Air Inlet to
Designated Jet Groups.

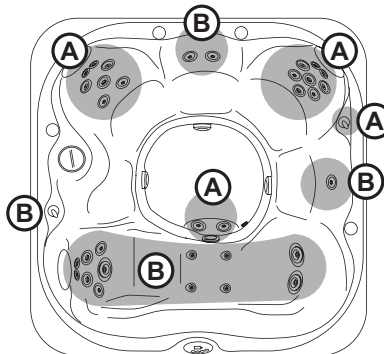



9.0 Operating Instructions

The spa control system has automatic functions that operate upon start-up and normal operation to protect the system. Upon power up, the readout displays the following information:

1. Control panel displays current software release (e.g. 5.54), then;
2. Control panel displays "888" and all indicator LEDs are lit, permitting visual inspection of all display segments and indicator lights for proper operation.
3. After the initial start-up sequence ends, the actual water temperature is displayed. If water temperature at this time is less than the factory default temperature setting of 100 °F (38 °C) and the spa is set to either standard skimming/heating mode "F1-F3", the heater will turn on and run until the water temperature rises to the factory setting, then turn off. *Note: it is common for the heater to turn on after the spa is first filled because tap water is often very cold.*

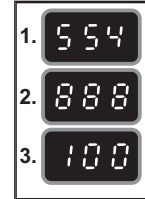

9.1 Setting Water Temperature

The spa's thermostat provides optimum control of water temperature. The temperature setpoint (set temperature) can be adjusted from 65 °F to 104 °F (18 °C to 40 °C). To raise the set temperature, press the **WARMER (+)** button. To lower the set temperature, press the **COOLER (-)** button. *Note: The first press of either **WARMER (+)** or **COOLER (-)** button displays the set temperature.*

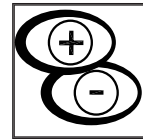

9.2 Activate Pumps

The **JETS 1** button activates the functions of the main 2-speed jets pump. The first press activates pump 1 in low speed, the second press activates high speed, and the third press shuts the pump off. The **JETS 2** button controls jets pump 2 which only operates in high speed. Both pumps have a twenty-minute default when manually activated.

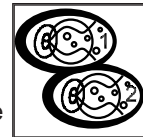

9.3 Light Button

The **LIGHT** button activates the spa light when pressed. The light has a one-hour default.

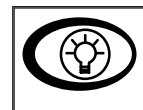

9.4 Selecting Desired Massage Action

Your Jacuzzi is equipped to allow you to customize the massage action you desire. Each model incorporates a massage selector



that allows you to customize the massage and performance by diverting water between various jet systems. Simply turn massage selector to position A (Combo), B, or C to divert water pressure to various jet groups. *Note: The valve is designed to operate in positions A (Combo), B, and C for optimum performance. It is considered normal for sound levels within the valve to vary between positions due to the large amounts of water flowing through it! For optimum filtration benefits, leave the valve in position A when spa is covered. Select position B or C for maximum jet performance during spa use.*

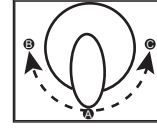

9.5 Adjusting Individual Jet Flow

The water flow to the individual jets in your spa can be increased or decreased by rotating the outside jet face. *Note: Always keep at least 6 adjustable jets open at all times.*



9.6 Air Controls

Certain jet systems have their own air control. Each control introduces air into the water lines that supply that specific jet group. Simply turn the air control selection to open or close. To minimize heat loss, all air controls should be closed when the spa is not in use.

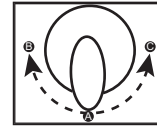

CAUTION: Never step or sit on a speaker enclosure! This type of misuse will damage the speaker enclosure latching and track mechanism. Always retract speakers prior to covering spa.



10.0 Automatic Filtration Cycles

The control system activates a programmable “standard” or “economy” filtration cycle to remove debris from your spa. These cycles use the low speed pump, skimmer basket, and filter cartridge quickly clear “skim” the water of debris and minimize their “bathtub ring” affect. Apart from their filtration benefit, each mode also effects the operation of your spa’s heater. Refer to sections 10.1 and 10.2 below for additional information.

10.1 Standard Filtration/Heating Modes (F1-F3)

Standard filtration/heating modes are typically selected by customers in cold climates where heatup times are extended due to lower ambient temperatures. In these modes, the water temperature is regulated by the set temperature, low-speed pump, and heater which turns on as needed. After the programmed set temperature is reached, the heater and pump turn off, only to turn back on at the next programmed filtration/heating cycle or during a heat call.

10.2 Economy Filtration/Heating Modes (F4-F6)

Economy filtration/heating modes are typically selected by customers in warm climates where heatup times are minimized due to higher ambient temperatures. In these modes, the water temperature is regulated by the set temperature, low-speed pump, and heater only while a programmed filtration/heating cycle is running. Note: these modes consume far less energy than standard modes F1-F3 outlined above.

10.3 Lock Modes (L1 - L2)

These modes are designed for use during spa service or to prevent unauthorized use.

10.4 Selecting The Skimmer/Heating Mode

Press and hold both control panel **WARMER (+)** and **COOLER (-)** buttons **at the same time**, then release. Then press either **WARMER (+)** or **COOLER (-)** button to select skimming/heater mode F1-F6 or lock modes L1-L2 on page 21:



Standard Filtration/Heating Modes (F1-F3)

- F1** 4 hours of filtration/heating per day (one 2-hour cycle every 12 hours).
- F2** 6 hours of filtration/heating per day (one 2-hour cycle every 8 hours).
- F3** 8 hours of filtration/heating per day (one 2-hour cycle every 6 hours)



Economy Filtration/Heating Modes (F4-F6)

- F4** 4 hours of filtration/heating per day (one 2-hour cycle every 12 hours).
- F5** 6 hours of filtration/heating per day (one 2-hour cycle every 8 hours).
- F6** 8 hours of filtration/heating per day (one 2-hour cycle every 6 hours)



Lock Modes (L1-L2)

- L1** Lock Out (disables all spa functions to permit filter cleaning)
- L2** Lock Mode (disables the jets and light buttons to prevent unauthorized use of spa). Filtration/heating cycle will continue to operate as programmed in this mode. The temperature display flashes when this function is enable. Example: the "F3" filtration/heating cycle was enabled prior to choosing lock mode. The spa continues to perform the "F3" cycle until lock mode is canceled, allowing another cycle to be selected.



To set a time for the first filtration/heating cycle, simply turn power on to the spa two minutes prior to the desired time. **EXAMPLE:** If you desire your first filtration/heating cycle to begin at 10:00 AM turn off power to the spa and turn it back on again at 9:58 AM. Note: start time is approximate and may vary slightly from day to day.



11.0 Spa Maintenance

Proper and regular maintenance of your spa will help it retain its beauty and performance. Your authorized Jacuzzi dealer can supply you with all the information, supplies, and accessory products you will need to accomplish this.

11.1 Cleaning The Filter

Your Jacuzzi spa is equipped with a skimmer basket and filter cartridge located in the skimmer/filter well. Filtering is accomplished when the pump turns on in low speed initiates water flow through the skimmer basket and polyester mesh filter cartridge. As this happens, suspended particles become trapped on the filter's surface. To ensure optimum performance, it is necessary to remove and clean the skimmer basket and filter cartridge, usually once a week, depending on usage and water quality. To accomplish this, follow these steps:

1. **Turn off power to the spa at the home's breaker panel or select the L1 "Lock Out" mode (Page 21) to disable all spa functions.**
2. Remove the filter strainer lid assembly.
3. Remove the filter cartridge by rotating it counterclockwise to unthread it from the filter wall fitting, then lift it straight up to remove from filter well.
4. Using a garden hose with a high-pressure nozzle to rinse debris from the filter pleats beginning at the top and working your way downward. Continue, one section at a time, until you have rinsed all of the filter's pleats.

Periodically, the filter cartridge will need a more thorough cleaning to remove imbedded oils and minerals. For this, we suggest cleaning as above and then soaking the cartridge overnight in a plastic container filled with a solution of water and a specially formulated filter cleanser available from your Jacuzzi dealer. The average life expectancy of a Jacuzzi filter cartridge is approximately two years with proper care and water quality maintenance. A replacement cartridge may be purchased from your dealer.

11.2 Draining and Refilling

About every 3 to 6 months, you will want to replace the spa's water. The frequency depends on a number of variables including the amount of use, attention paid to water quality maintenance, etc. You will know it is time for a change when you cannot control sudsing and/or you can no longer get the normal feel or sparkle to the water even though the key water balance measurements are all within the proper parameters.



WARNING! READ THIS BEFORE DRAINING: To prevent damage to the spa's components, **turn off power to the spa at the circuit breaker before draining it.** Do not turn the power back on until your spa has been refilled.



CAUTION: There are certain precautions to keep in mind when draining your spa. If it is extremely cold, and the spa is outdoors, freezing could occur in the lines or the equipment (see "WINTERIZING", Page 24). On the other hand, if it is hot outdoors, do not leave the spa's surface exposed to direct sunlight.

To drain your spa, remove the front cabinet panel and the drain hose. Pull out the drain hose. Raise the end of the hose above the water level, remove the cap and remove the cap and connect the garden hose to the male garden hose fitting. Lay the garden hose away from the equipment and turn the knob on the valve to drain the hot tub.

After refilling, turn on power to the spa and follow the steps listed under "Start-Up Instruction."

11.3 Cleaning The Spa Interior

To preserve the sheen of your spa's surface, it is crucial that you avoid using abrasive cleaners or cleaners which have adverse chemical effect on the surface. If you are not certain as to the suitability of a particular cleanser, consult your authorized Jacuzzi dealer. Regardless of the cleanser used, use extreme care to assure that no soap residue is left on the surface. This could cause severe sudsing when the spa is refilled.

11.4 Pillow Care

Remove and clean the headrest pillows as needed with soapy water using a cloth or soft-bristle brush. To maintain water resistance and luster, apply a quality vinyl conditioner once a month. Always remove the pillows when adding chemical shock treatment to the spa water. The pillows can be returned to the spa when the sanitizer reading drops below 5 ppm.

11.5 Maintaining the Cover

Using the Jacuzzi insulating spa cover anytime the spa is not in use will significantly reduce your operating costs, heat-up time and maintenance requirements. To prolong the life of the cover, handle it with care and clean it regularly using mild soap and water. Periodic treatments with a special conditioner developed for Jacuzzi spa covers will help protect against deterioration caused by UV rays from the sun.



Never allow anyone to stand or sit on the cover, and avoid dragging it across rough surfaces.

11.6 Maintaining The Synthetic Cabinet

Your new spa's synthetic cabinet requires little or no maintenance of any kind. To clean, simply wipe cabinet with a clean towel and mild soap solution.



CAUTION: Never spray cabinet with a garden hose for any reason since this action may induce an electrical short in the spa's electrical equipment.

11.8 Winterizing

Your Jacuzzi spa is designed to automatically protect itself against freezing when operating properly. During periods of severe freezing temperatures, you should check periodically to be certain that the electrical supply to the spa has not been interrupted. In extreme, bitter cold weather less than -20°F (-29 °C), choose the F3 "Standard" skimming/heating mode to prevent freezing (Page 21).

If you do not intend to use your spa, or if there is a prolonged power outage during periods of severe freezing temperatures, it is important that all water be removed from the spa and equipment to protect against damage from freezing. **For expert winterization of your spa, contact your authorized Jacuzzi dealer.** In emergency situations, damage can be minimized by taking the following steps:

1. Follow the directions on pages 22-23 for draining the spa.
2. As the water level drops below the seats, use whatever means necessary to get the water out of the recessed seating areas and into the footwell.
3. When the water level ceases to drop, use whatever means available to remove any remaining water from the footwell.
4. *Turn off power to the spa.*
5. Remove the equipment-side cabinet panels and locate the drain plugs in the front of the pump(s) (Figure-A, Page 11). Remove these plugs to allow the water to drain out of the pumps and heater. *Note: Approximately one to two gallons will be released during this procedure. Use a wet/dry vacuum or other means to keep this from flooding the equipment compartment. Replace the drain plugs.*



6. Re-install cabinet side panels and cover spa so that no casual moisture can enter into it.

Consult your Authorized Jacuzzi Dealer if you have any questions regarding winter use or winterizing.

11.9 Restarting Your Spa in Cold Weather

If you want to start up your spa after it has sat empty for a time in freezing temperatures, be aware that the water remaining in certain sections of the piping may still be frozen. This situation will block water flow preventing the spa from operating properly and possibly damaging the equipment. We recommend you consult your dealer for guidance before attempting to re-start your spa under these conditions.

12.0 Water Quality Maintenance

Maintaining the quality of the water within specified limits will serve to enhance your enjoyment and prolong the life of the spa's equipment. It is a fairly simple task, but it requires regular attention because the water chemistry involved is a balance of several factors. There is no simple formula, and there is no avoiding it. A careless attitude in regard to water maintenance will result in poor and potentially unhealthful conditions for soaking and even damage to your spa. For specific guidance on maintaining water quality, consult your Authorized Jacuzzi dealer who can recommend appropriate chemical products for sanitizing and maintaining your spa.



CAUTION: *Never store spa chemicals inside the spa's equipment bay.*

12.1 pH Control

pH is a measure of relative acidity or alkalinity of water and is measured on a scale of 0 to 14. The midpoint of 7 is said to be neutral, above which is alkaline and below which is acidic. In spa water, IT IS VERY IMPORTANT TO MAINTAIN A SLIGHTLY ALKALINE CONDITION OF 7.2 to 7.8. Problems become proportionately severe the further outside of this range the water gets. A low pH will be corrosive to metals in the spa equipment. A high pH will cause minerals to deposit on the interior surface (scaling). In addition, the ability of the sanitation agents to keep the spa clean is severely affected as the pH moves beyond the ideal range. That is why almost all spa water test kits contain a measure for pH as well as sanitizer.



12.2 Sanitizing

To destroy bacteria and organic compounds in the spa water, a sanitizer must be used regularly. Chlorine and Bromine are the two most popular sanitizers used to date. Many other additives are available for your spa. Some are necessary to compensate for out-of-balance water, some aid in cosmetic water treatment and others simply alter the feel or smell of the water. Your Authorized Jacuzzi dealer can advise you on the use of these additives.



CAUTION: *Do not use chlorine tablets (Trichlor) in your spa. This chemical can have an extremely corrosive effect on certain materials in the spa. Damage caused by use of this chemical, or improper use of any chemicals, is not covered under the spa's warranty.*

12.3 Optional CD Ozone Water Maintenance System

If you have elected to have your spa equipped with the optional Jacuzzi CD Ozone water purification system you will find that your water stays fresh and clear with significantly less chemical sanitizer usage. You will also probably be able to go longer between complete spa drainings. The CD ozone unit operates in conjunction with low speed pump #1.

13.0 Error Conditions / Error Messages

Your spa has a self-diagnostic control system. The system will automatically display the following if a problem is detected.

13.1 Panel displays SN1

Open sensor (heater is disabled) or shorted sensor (spa is deactivated). The high-limit temperature sensor is not functioning. Your authorized dealer must repair this.



13.2 Panel displays SN2

Open or shorted sensor (heater disabled). The temperature sensor is not functioning. Your authorized dealer must repair this



13.3 Panel Displays FL1

Pressure switch is not closed when the pump is activated. Heater is deactivated. Proper flow of water is inhibited or pressure switch has malfunctioned. Check for proper water





level, pump is primed and/or clogged filter. Contact a qualified service technician.

13.4 Panel Displays FL2

Pressure switch is closed, while pump is deactivated. Contact a qualified technician.

13.5 Panel displays COL

Cool Condition - Temperature has dropped 20 °F (11 °C) below the current set temperature. The pump and heater have been activated to bring the temperature to within 15 °F (8 °C) of the set temperature. No corrective action is required. *Note: during cold periods, you may consider increasing the number of filtration cycles.*



13.6 Panel Displays ICE

Freeze Protection - A potential freeze condition has been detected. No action is required. The pump and heater will operate to circulate and warm water through the plumbing until spa is out of danger (see “Winterizing”, page 24).



13.7 Panel Displays OH

Water temperature is above acceptable limits. Do not enter spa! Water temperature has reached 112°F (44°C) and the low speed pump has activated to circulate water through heater.



13.8 Panel displays - - -

The safety “Watchdog” software has been triggered and the spa is deactivated. A problem has been detected which could cause damage to the spa or its components. Contact your authorized dealer.

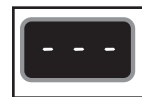

14.0 Troubleshooting Procedures

In the event your Jacuzzi® spa is not working the way it should, please first review all the installation and operating instructions in this manual and check the message on the panel display. If you are still not satisfied it is working properly, please follow the appropriate troubleshooting instructions. *Note: If any of the supply cords to the accessories are damaged, they must be replaced by authorized service personnel.*



14.1 None of the Components Operate (e.g. Pump, Light)

Check the following:

1. Is there power to the spa?
2. Is the household circuit breaker tripped?
3. Call your authorized dealer.

14.2 Pump Does Not Operate but Light Does

Press the JETS Button:

1. If no water movement is detected, make sure power is going to the spa and check the water level. If it does not solve the problem, contact your authorized Jacuzzi dealer.
2. The main pump operates but no water flows to jets. Pump may not be properly primed. This can happen after the spa is drained and refilled. Press the JETS 1 button several times, never leaving the motor on for more than 5 to 10 seconds at a time. Turn power off and let the air out by loosening the cap on the diverter valve and/or remove the filter. Refer to section 8.2 (page 15). Make certain you tighten the diverter cap and/or reinstall the filter before turning on spa power and restarting the pump.

14.3 Poor Jet Action

1. Press the JETS 1 button to make certain the pump #1 is on.
2. Depress the air control to the "on" position.
3. Check for dirty filter. Clean, if necessary.
4. Make sure jets are all the way open.

14.4 Water is Too Hot

Reduce thermostat setting.

14.5 No Heat

1. Check thermostat setting.
2. Keep the spa cover in place while heating.
3. Check the settings to see if your spa is in economy filtration / heating mode (page 20-21).

Should checking the above steps fail to correct the problem, please call your dealer so that they may arrange service.



We build the best spas in the industry. Nonetheless, we are always striving to improve the quality and features of our products. Your input as a Jacuzzi spa owner is a cherished part of this process. If you have any comments or suggestions, or if you wish to be informed on any new products for your spa, please write to us.

CONGRATULATIONS on your good taste and welcome to the happiest and most relaxed family in the world!



15.0 J-210, J-220 Convertible Circuit Diagram (60Hz)

This wiring diagram is used for the J-210, J-220 US/Canada 120/240 VAC (60Hz) convertible power model.

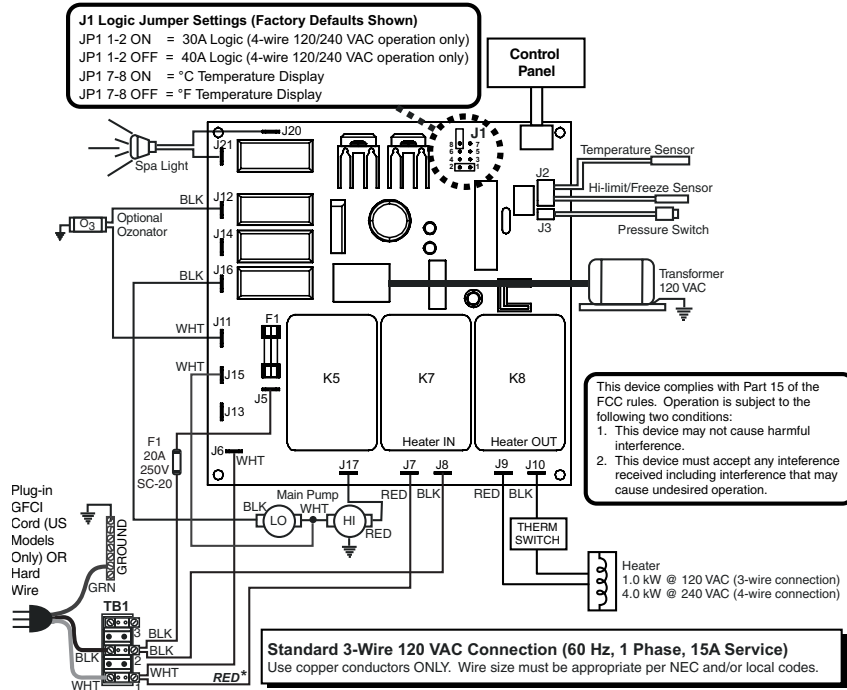

WARNING, ELECTRICAL SHOCK HAZARD EXISTS! Always remove power to spa before wiring and/or configuring the circuit board

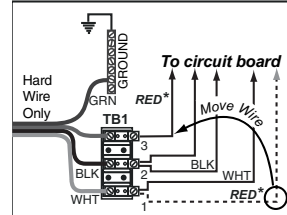

Optional 4-Wire 240/120 VAC Convertible Heater Connection

1. Remove and discard the factory installed GFCI Cord.
2. Move RED* wire from TB1 position #1 to TB1 position #3 as shown below.
3. Permanently connect to the power supply. Use copper conductors ONLY. Wire size must be appropriate per NEC and/or local codes.
4. If hot tub is to be operated on 30A service, make sure the jumper provided at location JP1 #1&2 on the circuit board is installed. If hot tub is to be operated on 40A service, remove the jumper JP1 #1&2 on the circuit board.



16.0 J-230 Circuit Diagram (60Hz)

This wiring diagram is used for all J-230 US/Canada 240 VAC (60Hz) dedicated power models.

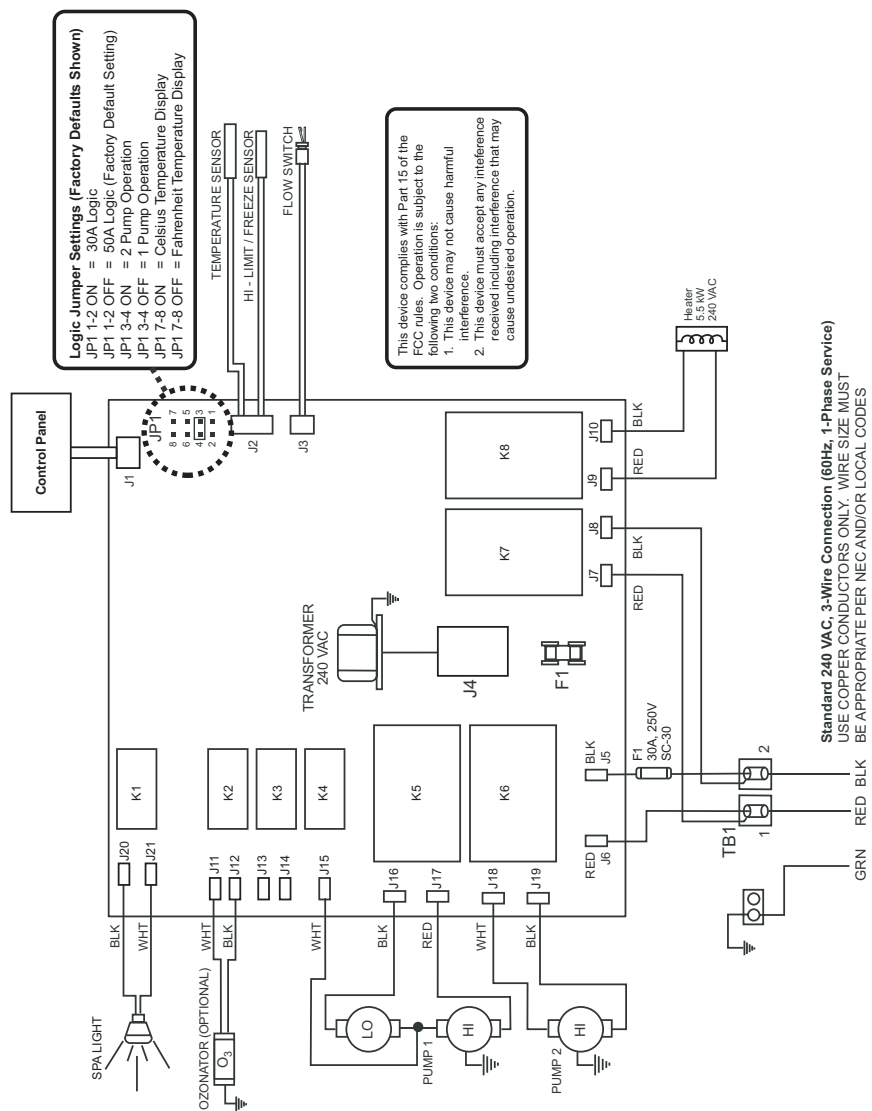



17.0 J-210, J-220 Export Circuit Diagram (50Hz)

This wiring diagram is used for the J-210, J-220 Export 230 VAC (50Hz) dedicated power model.

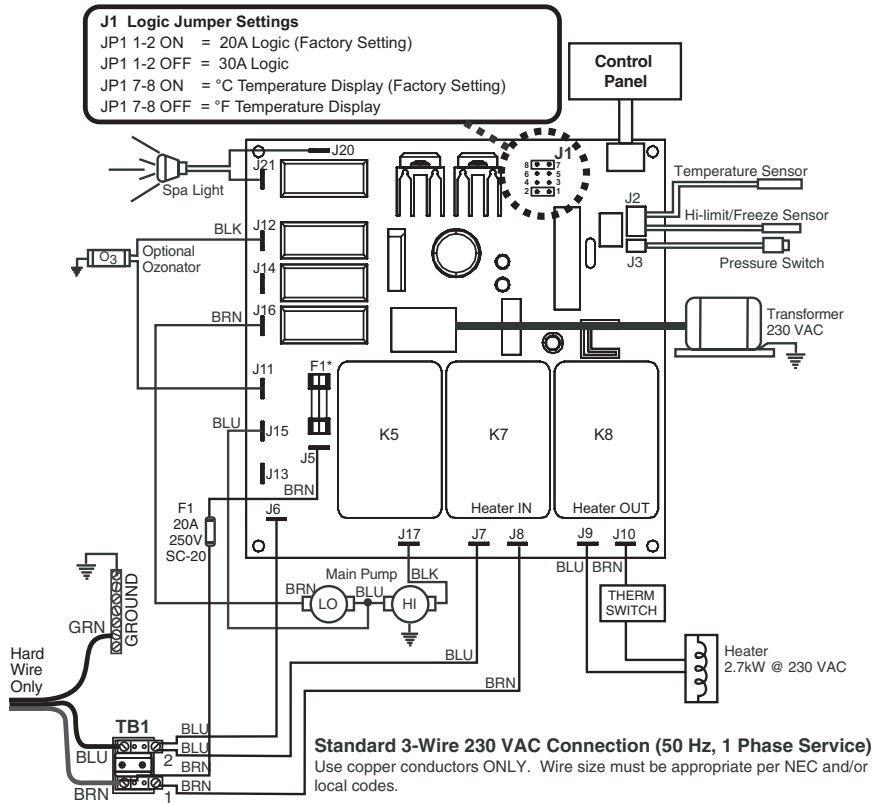



18.0 J-230 Circuit Diagram (50Hz)

This wiring diagram is used for all J-230 Export 230 VAC (50Hz) dedicated power models.

