



• J-280™

• J-275™

• J-245™

• J-235™

• J-225™

• J-215™

• J-210™

J-200™ COLLECTION  
**EXPORT OWNER'S MANUAL**

2530-277EE Rev B

# Attention New Spa Owner!

Congratulations on the purchase of your new Jacuzzi® spa! The following is a list of automated functions performed by your spa. These functions are listed below in an attempt to alleviate any operational concerns you may have during the first 24 hours of ownership! Also listed below are important maintenance recommendations you should observe on a regular basis to protect your new investment.

## Automated Operations

Your new spa is equipped with an automated “clean-up” cycle that clears all plumbing lines daily to promote maximum water sanitation. Each day at 12:00 PM (noon), each pump will activate and run for one minute. If either pump has just finished a 20 minute time out, it will not automatically activate for the clean-up cycle.

**Note:** Turning off the corresponding jets pump that is running can deactivate the feature.

## Maintain Healthy Spa Water

Always maintain your spa's water chemistry within the following parameters:

	With CLEARRAY®	Without CLEARRAY®
pH	7.4-7.6	7.4-7.6
Free Chlorine	no less than 1.0 ppm	3.0-4.0 ppm
Free Bromine	no less than 2.0 ppm	2.0-4.0 ppm
Total Alkalinity	100-150 ppm	100-150 ppm
Calcium Hardness	150-250 ppm	150-250 ppm

**IMPORTANT:** CLEARRAY® Water Purification System is factory installed. If the CLEARRAY® system is altered or is not operating efficiently then follow the “without CLEARRAY®” water chemistry parameters as defined by the Association of Pool and Spa Professionals. CLEARRAY® requires an annual bulb replacement to properly sanitize your water.

 **TO DECREASE RISK OF INFECTION OR DISEASE!** Always maintain your spas filter as outlined below to ensure healthy spa water. Refer page 41 “Water Quality Maintenance” for additional information.

## Required Filter Maintenance

Your new spa is equipped with an advanced water filtration system that provides unsurpassed water quality! To ensure maximum water quality at all times, you should clean the filter cartridge once a month, or earlier as necessary. See page 34 for detailed filter cartridge cleaning/replacement instructions.

## Required Water Replacement

 **TO DECREASE RISK OF INFECTION OR DISEASE!** You should replace the spa's water every 3 months. The frequency depends on a number of variables including frequency of use, number of users, and attention paid to water quality maintenance. You will know it is time for a change when you cannot control sudsing and/or you can no longer get the normal feel or sparkle to the water, even though the key water balance measurements are all within the proper parameters. See page 41 for additional information.

# Table of Contents

<b>1.0</b>	<b>Important Spa Owner Information.....</b>	<b>1</b>
<b>2.0</b>	<b>FCC Notice .....</b>	<b>1</b>
<b>3.0</b>	<b>Important Safety Instructions for all Spa Owners .....</b>	<b>2</b>
3.1	Entrapment Risk .....	6
3.2	Hyperthermia .....	7
3.3	Important Safety Instructions.....	8
3.4	General Electrical Safety Instructions.....	8
<b>4.0</b>	<b>Choosing A Location.....</b>	<b>9</b>
4.1	Outdoor Location .....	10
4.2	Indoor Location .....	10
<b>5.0</b>	<b>General Electrical Safety Instructions.....</b>	<b>11</b>
<b>6.0</b>	<b>Power Requirements.....</b>	<b>12</b>
<b>7.0</b>	<b>Electrical Wiring Instructions.....</b>	<b>14</b>
<b>8.0</b>	<b>Spa Fill Up Procedure .....</b>	<b>17</b>
<b>9.0</b>	<b>Control Functions.....</b>	<b>22</b>
9.1	Control Panel .....	22
9.2	General Spa Features and Controls.....	23
9.3	General Spa Features and Controls.....	24
<b>10.0</b>	<b>Operating Instructions .....</b>	<b>25</b>
10.1	Setting Water Temperature.....	25
10.2	Activate Jets Pump.....	26
10.3	Multi-Colored LED Light System Operation.....	26
10.4	Adjusting Individual Jet Flow .....	26
10.5	Selecting Desired Massage Action .....	27
10.6	Air Controls.....	27
10.7	Optional BLUEWAVE® Spa Stereo System (J-215 to J-280).....	27
10.8	Blow-Out Cycle.....	27
10.9	Cleanup Cycle .....	27
<b>11.0</b>	<b>Menu Features and Programming Instructions.....</b>	<b>28</b>
11.1	Programming the Primary Filtration.....	28
11.2	Programming the Heating Mode.....	29
11.3	Programming the Change Filter Timer .....	30
11.4	Programming the CLEARRAY® Timer.....	30
11.5	Programming the Water Refresh Timer.....	31
11.6	Programming the Time .....	31
11.7	Programming the Date.....	32
11.8	Programming the Temperature Format .....	32
11.9	Programming the Language.....	32
11.10	Programming the Lock Feature .....	33

## **J-200 Export**

<b>12.0 Spa Maintenance</b> .....	<b>34</b>
12.1 <i>Cleaning The Filters</i> .....	34
12.2 <i>Draining and Refilling</i> .....	38
12.3 <i>Pillow Care</i> .....	38
12.4 <i>Cleaning The Spa Interior</i> .....	39
12.5 <i>Cover Care and Maintenance</i> .....	39
12.6 <i>Maintaining The Synthetic Cabinet</i> .....	40
12.7 <i>Winterizing</i> .....	40
12.8 <i>Restarting Your Spa in Cold Weather</i> .....	41
<b>13.0 Water Quality Maintenance</b> .....	<b>41</b>
13.1 <i>pH Control</i> .....	42
13.2 <i>Sanitizing</i> .....	42
13.3 <i>CLEARARRAY® Water Purification System</i> .....	42
13.4 <i>CLEARARRAY® Lamp Replacement and Quartz Tube Maintenance</i> .....	43
<b>14.0 Error Conditions/Error Messages</b> .....	<b>46</b>
14.1 <i>Panel Displays COOL</i> .....	46
14.2 <i>Panel Displays ICE</i> .....	46
14.3 <i>Panel Displays SN--1</i> .....	46
14.4 <i>Panel Displays SN--2</i> .....	46
14.5 <i>Panel Displays Change CLEARARRAY Bulb</i> .....	46
14.6 <i>Panel Displays Change Filter</i> .....	47
14.7 <i>Panel Displays Change Water</i> .....	47
14.8 <i>Panel Displays FL--1</i> .....	47
14.9 <i>Panel Displays FL--2</i> .....	47
14.10 <i>Panel Displays FL--3</i> .....	47
14.11 <i>Panel Displays OH</i> .....	48
14.12 <i>Panel Displays (-- -- --)</i> .....	48
<b>15.0 Troubleshooting Procedures</b> .....	<b>49</b>
15.1 <i>None of the Components Operate (e.g. Pump, Light)</i> .....	49
15.2 <i>Pump Does Not Operate But Light Does</i> .....	49
15.3 <i>Poor Jet Action</i> .....	49
15.4 <i>Water is Too Hot</i> .....	49
15.5 <i>No Heat</i> .....	50
<b>16.0 Circuit Board Diagrams</b> .....	<b>51</b>
16.1 <i>Export 50 Hz 2-Pump Models</i> .....	51
16.2 <i>Export 50 Hz 1-Pump Models</i> .....	52
<b>17.0 Dip Switch Settings and Wiring</b> .....	<b>53</b>
17.1 <i>Switch settings for Export 50Hz Models</i> .....	53
17.3 <i>Single Service 50Hz Connection</i> .....	54
17.4 <i>Dual Service 50Hz Connection</i> .....	55
17.5 <i>Three Service 50Hz Connection</i> .....	55
<b>18.0 Optional BLUEWAVE® Spa Stereo System</b> .....	<b>56</b>
18.1 <i>Electronic Device Connections and Functions</i> .....	57
18.2 <i>Stereo Cautions</i> .....	58

## **1.0 Important Spa Owner Information**

Your Jacuzzi J-200 Collection spa is constructed to the highest standards and is capable of providing many years of trouble-free use. However, because heat retentive materials are utilized to insulate the spa for efficient operation, an uncovered spa surface and wall fittings directly exposed to sunlight and high temperatures for an extended period are subject to permanent damage. Damage caused by exposing the spa to this abuse is not covered under warranty. We recommend that you always keep the spa full of water when it is exposed to direct sunlight and that you keep the Jacuzzi premium insulating cover in place at all times when the spa is not in use. Read and carefully follow the requirements for your spa's support base found in Section 4.0 titled, "Choosing A Location" (page 54).

**Jacuzzi constantly strives to offer the finest spas available, therefore modifications and enhancements may be made which affect the specifications, illustrations and/or instructions contained herein.**

## **2.0 FCC Notice**

This equipment has been tested and found to comply with the limits for a Class B Digital Device, pursuant to Part 15 of the FCC Rules. These limits are designed to provide reasonable protection against harmful interference in a residential installation. This equipment generates, uses and can radiate radio frequency energy and, if not installed and used in accordance with the instructions, may cause harmful interference to radio communications. However, there is no guarantee that interference will not occur in a particular installation. If this equipment does cause harmful interference to radio or television reception, which can be determined by turning the equipment off and on, the user is encouraged to try to correct the interference by one or more of the following measures:



1. Rearrange or relocate the receiving antenna.
2. Increase the separation between the equipment and receiver.
3. Connect the equipment into an outlet on a circuit different from the circuit connected.
4. Consult the dealer or an experienced radio/TV technician for help. Changes or modifications not expressly approved by the party responsible for FCC compliance could void the user's authority to operate this equipment.

## J-200 Export

### 3.0 Important Safety Instructions for all Spa Owners

#### READ AND FOLLOW ALL INSTRUCTIONS CAREFULLY!

This spa was manufactured to meet the standards and specifications outlined in the “Virginia Graeme Baker Pool and Spa Safety Act” (VGB Safety Act). When installing and using this spa, basic safety precautions should always be followed, including:

1.  **DANGER: RISK OF SEVERE INJURY OR DROWNING!**
  - Extreme caution must be exercised to prevent unauthorized access by children.
  - To avoid accidents, ensure that children do not use this spa unless supervised at all times. Adult supervision is a critical safety factor in preventing children from drowning.
  - Use the straps and clip tie downs to secure the spa cover when not in use. This will help discourage unsupervised children from entering the spa. Keep the spa cover secure in high-wind conditions.
  - There is no representation that the cover, clip tie-downs, or actual locks will prevent access to the spa.
  
2.  **DANGER: RISK OF SEVERE INJURY OR DROWNING!**
  - Keep hair, loose articles of clothing or hanging jewelry away from suction fittings, rotating jets or other moving components to avoid entrapment that could lead to drowning or severe injury.
  - Never use the spa unless all suction guards, filter, filter lid, or skimmer assembly are installed to prevent body and/or hair entrapment.
  - Never operate or use the spa if the filter, filter lid, or skimmer assembly are broken or any part of the skimmer assembly is missing. Please contact your dealer or nearest service center for service.
  - The suction fittings and suction covers in this spa are sized to match the specific water flow created by the pump(s). If it is necessary to replace the suction fittings, suction covers or pump(s), be sure that the flow rates are compatible and are in compliance with the VGB Safety Act.
  - Never replace a suction fitting or suction cover with one rated less than the flow rate marked on the original suction fitting. Using improper suction fittings or suction covers can create a body or hair suction entrapment hazard that may lead to drowning or severe injury.
  
3.  **DANGER: RISK OF SEVERE INJURY FROM ELECTRIC SHOCK OR DEATH FROM ELECTROCUTION!**
  - Install the spa at least 5 feet (1.5m), from all metal surfaces. As an alternative, a spa may be installed within 5 feet of metal surfaces if each metal surface is permanently connected (bonded) by a minimum No. 8 AWG (8.4 mm<sup>2</sup>) solid copper conductor attached to the wire connector on the grounding lug, inside the equipment compartment on the equipment box.

- A grounding wire connector is provided on this unit to connect a minimum No. 8 AWG (8.4 mm<sup>2</sup>) solid copper conductor between this unit and any metal equipment, metal enclosures of electrical equipment, metal water pipe, or conduit within 5 feet (1.5m) of the unit.
- Never permit any electrical appliance, such as a light, telephone, radio, television, etc. within 5 feet (1.5m) of a spa unless such appliances are built-in by the manufacturer.
- Never bring any electrical appliances into or near the spa.
- Never operate any electrical appliances from inside the spa or when you are wet.
- The electrical supply for this product must include a suitably rated switch or circuit breaker to open all ungrounded supply conductors to comply with Section 422-20 of the National Electrical Code/USA, ANSI/NFPA 70. The disconnecting means must be readily accessible and visible to the spa occupant but installed at least 5 feet (1.5m), from the spa.
- The electrical circuit supplied for the hot tub must include a suitable ground fault circuit interrupter (GFCI) as required by NEC Article 680-42.



4.  **WARNING: RISK OF SEVERE INJURY OR DEATH!**

- Extreme caution must be exercised to prevent diving or jumping into the spa or slipping and falling, which could result in unconsciousness, drowning, or serious injury. Remember that wet surfaces can be very slippery.
- Never stand, walk or sit on the top railing of the spa.



5.  **WARNING: RISK OF HYPERTHERMIA (OVER-HEATING) CAUSING SEVERE INJURY, BURNS, WELTS OR DEATH!**

- Water temperature in excess of 104°F (40°C) may be injurious to your health.
- Refer to Section 3.2 Hyperthermia for specific causes and symptoms of this condition.
- The water in the spa should never exceed 104°F (40°C). Water temperatures between 100°F (38°C) and 104°F (40°C) are considered safe for a healthy adult.
- Lower water temperatures are recommended for young children (children are especially sensitive to hot water) and when spa use may exceed 10 minutes.
- The Consumer Products Safety Commission/USA has stated that the water temperature in a spa should not exceed 104°F (40°C).
- Always test the spa water temperature before entering the spa. The user should measure the water temperature with an accurate thermometer since the tolerance of water temperature-regulating devices may vary as much as +/- 5°F (2°C).

## J-200 Export

6.  **WARNING: RISK OF SEVERE INJURY OR DEATH!**
- Since excessive water temperatures have a high potential for causing fetal damage during the early months of pregnancy, if pregnant or possibly pregnant, consult your physician before using a spa.
  - Pregnant or possibly pregnant women should limit spa water temperatures to 100°F (38°C).
  - Persons suffering from obesity or a medical history of heart disease, low or high blood pressure, circulatory system problems, diabetes, infectious diseases or immune deficiency syndromes should consult a physician before using a spa.
  - If you experience breathing difficulties in association with using or operating your spa, discontinue use and consult your physician.
  - Persons using medication should consult a physician before using a spa since some medication may induce drowsiness, while other medication may affect heart rate, blood pressure, and circulation.
  - Persons suffering from any condition requiring medical treatment, the elderly, or infants should consult with a physician before using a spa.
  - The use of alcohol, drugs, or medication before or during spa use may lead to unconsciousness with the possibility of drowning.
7.  **WARNING: RISK OF SEVERE INJURY OR DEATH!**
- Prolonged immersion in a spa may be injurious to your health.
  - Observe a reasonable time limit when using the spa. Exposures at higher temperatures can cause high body temperature (overheating). Symptoms may include dizziness, nausea, fainting, drowsiness, and reduced awareness. These effects could possibly result in drowning or serious injury.
  - Never use a spa immediately following strenuous exercise. Enter and exit the spa slowly. Wet surfaces can be slippery.
8.  **WARNING: TO DECREASE RISK OF INFECTION OR DISEASE!**
- To reduce the risk of contracting a waterborne illness (e.g. an infection, bacteria or virus) and/or respiratory ailments, maintain water chemistry within the parameters listed on the inside cover of this manual and consult with a licensed engineer regarding proper ventilation if installed indoors or in an enclosed area.
  - People with infectious diseases should not use a spa to avoid water contamination, which could result in spreading infections to others.
  - Always shower before and after using your spa. Maintain water chemistry in accordance with manufacturer's instructions. Failure to do so may result in contracting a waterborne illness (e.g. an infection, bacteria or virus).



9.  **WARNING:** In addition to maintenance of filters and water chemistry, proper ventilation is recommended to reduce the risk of contracting a waterborne illness (e.g. an infection, bacteria or virus) and/or respiratory ailments that could be present in the air or water. Consult a licensed architect or building contractor to determine your specific needs if installing your hot tub indoors.
10. **CAUTION: TO DECREASE RISK OF PRODUCT DAMAGE.**
- Maintain water chemistry in accordance with manufacturer's instructions.
  - Proper chemical maintenance of spa water is necessary to maintain safe water and prevent possible damage to spa components.
11.  **WARNING: RISK OF SEVERE INJURY OR DEATH!** The appliance is not intended for use by persons (including children) with reduced physical, sensory or mental capabilities, or lack of experience or knowledge, unless they have been given supervision or instruction concerning use of the appliance by a person responsible for their safety.
12. **NOTE:** This spa is not intended nor designed to be used in a commercial or public application. The spa buyer shall determine whether there are any code restrictions on the use or installation of this spa since local code requirements vary from one locality to another.

## **Hot Tub Safety Literature**

To ensure you have a safe and enjoyable hot tub experience, learn all you can about hot tub safety and emergency procedures. Especially useful are the brochures listed below:

- [Children Aren't Waterproof](#)
- [Pool and Spa Emergency Procedures For Infants and Children](#)
- [Layers of Protection](#)
- [The Sensible Way to Enjoy Your Spa or Hot Tub](#)

The Association of Pool and Spa Professionals publishes these brochures. To acquire a brochure:

- Ask your hot tub dealer (they may have copies)
- Go to <http://apsp.org>
- Conduct your own search on the internet
- Write to the following address:  
The Association of Pool and Spa Professionals  
2111 Eisenhower Avenue  
Alexandria VA 22314  
703.838.0083

# J-200 Export

## 3.1 Entrapment Risk



The Consumer Products Safety Commission/USA has reported that users of pools and spas have become entrapped (stuck) to drain and/or suction fittings causing death, drowning, or serious injury (see diagram below). This spa was manufactured to meet the standards and specifications outlined in the "Virginia Graeme Baker Pool and Spa Safety Act" (VGB Safety Act). Entrapment risk can be minimized if proper precautions are taken.



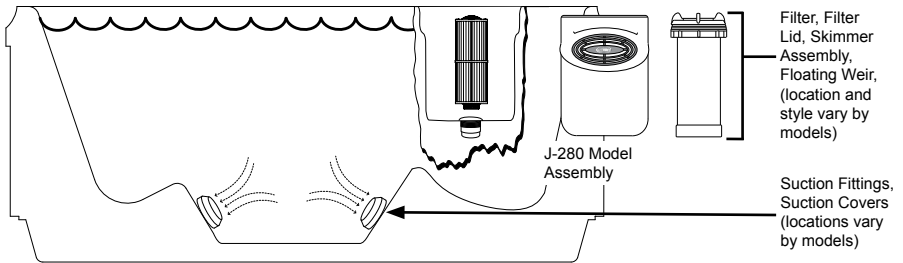

**DANGER: RISK OF PERSONAL INJURY OR DEATH!**  
Never operate the spa if a suction fitting, suction cover, filter, filter lid or skimmer assembly are broken, damaged or missing.



**Note: Suction covers must be replaced every 5 years.**

1.  **DANGER: RISK OF SEVERE INJURY OR DROWNING!**  
**Hair entrapment:** May occur if hair is entangled, knotted or snagged in a drain suction or skimmer assembly. This has been reported in persons who when submerge themselves underwater, allowing hair to come close and/or within the reach of the suction fittings, suction covers or skimmer assembly.
  - Keep hair away from suction fittings, suction covers, filter, filter lid or skimmer assembly.
  - Children are at risk for hair entrapment if swimming under water.
  - Never allow children to play or get near the suction fittings, suction covers, filter, filter lid or skimmer assembly.
  
2.  **DANGER: RISK OF SEVERE INJURY OR DROWNING!**  
**Limb entrapment:** May occur when a limb becomes entrapped, inserted or sucked into a suction or outlet opening.
  - Always keep suction fittings, suction covers, filter, filter lid or skimmer assembly in place when operating to avoid limb entrapment.
  - Never allow children to play or get near the suction fittings, suction covers, filter, filter lid or skimmer assembly.

3.  **DANGER: RISK OF SEVERE INJURY OR DROWNING!**  
**Body entrapment:** May occur when part of the torso becomes entrapped, inserted or sucked into a suction or outlet opening.
  - Never allow children to play or get near the suction fittings, suction covers, filter, filter lid or skimmer assembly.
  
4.  **DANGER: RISK OF SEVERE INJURY OR DROWNING!**  
**Evisceration (disembowelment) entrapment:** May occur when the buttocks becomes entrapped, inserted or sucked into a suction or outlet opening.
  - Never sit on suction fittings, suction covers, filter, filter lid or skimmer assembly.
  - Never allow children to play or get near the suction fittings, suction covers, filter, filter lid or skimmer assembly.
  
5.  **DANGER: RISK OF SEVERE INJURY OR DROWNING!**  
**Mechanical entrapment:** May occur when jewelry, swimsuit, or hair accessories become entangled, knotted or snagged in a drain suction or skimmer assembly.
  - Never allow your jewelry, swimsuit, or hair accessories to come close to the suction fittings, suction covers or skimmer assembly.
  - Never allow children to play or get near the suction fittings, suction covers, filter, filter lid or skimmer assembly.

### 3.2 Hyperthermia

Prolonged immersion in hot water may induce hyperthermia (overheating). The use of alcohol or drugs can greatly increase the risk of fatal hyperthermia in spas. A description of the causes, symptoms, and effects of hyperthermia are as follows.

Hyperthermia occurs when the internal temperature of the body reaches a level several degrees above the normal body temperature of 98.6°F (37°C). The symptoms of hyperthermia include drowsiness, lethargy (fatigue), and an increase in the internal temperature of the body. The effects of hyperthermia include:

- Unawareness of impending hazard;
- Failure to perceive heat;
- Failure to recognize the need to exit spa;
- Physical inability to exit spa;
- Fetal damage in pregnant women; and
- Unconsciousness and DANGER of drowning.

A Warning Sign is provided in your warranty packet. Please install at a location near your spa, where it is visible to users of the spa. For additional or replacement Warning Signs please contact your local Jacuzzi dealer and reference item number #6530-082.

## **J-200 Export**

### **3.3 Important Safety Instructions**

When using this electrical equipment, basic safety precautions should always be followed, including the following:

- 1. READ AND FOLLOW ALL INSTRUCTIONS.**
- A green colored terminal or a terminal marked G, Gr, Ground, Grounding or the  $\oplus$  symbol\* is located inside the supply terminal box or compartment. To reduce the risk of electric shock, this terminal must be connected to the grounding means provided in the electric supply service panel with a continuous copper wire equivalent in size to the circuit conductors that supply this equipment (\*IEC Publication 417, Symbol 5019).
- At least two lugs marked “Bonding Lugs” are provided on the external surface or on the inside of the supply terminal box/ compartment. To reduce the risk of electric shock, connect the local common bonding grid in the area of the spa to these terminals with an insulated or bare copper conductor not smaller than No. 6 AWG (10 mm<sup>2</sup>).
- All field installed metal components such as rails, ladders, drains or other similar hardware within 10 feet (3m) of the spa shall be bonded to the equipment grounding buss with copper conductors not smaller than No. 6 AWG (10 mm<sup>2</sup>).
- 5. SAVE THESE INSTRUCTIONS.**

### **3.4 General Electrical Safety Instructions**

Your new Jacuzzi spa is equipped with a “state-of-the-art” equipment system. It contains the most advanced safety and self-protective equipment in the industry. Nonetheless, this spa must be installed properly to ensure dependable usage. Please contact your local Jacuzzi dealer or local building department should you have any questions regarding your installation.

Proper grounding is extremely important. Jacuzzi spas are equipped with a current collector system. A pressure wire connector is provided on the surface of the control box, located outside the equipment door (Figure B, page 15) to permit connection of a bonding wire between this point and any ground metal equipment, metal water pipe or conduit within 5 feet (1.5m) of the spa, or copper clad grounding rod buried within 5 feet (1.5m) of the spa. Bonding wire must be at least No. 8 AWG (8.4 mm<sup>2</sup>) solid copper wire. This is a most important safety assurance feature.

Before installing your spa, check with your local building department to insure installation conforms to local building codes.

## 4.0 Choosing A Location

**IMPORTANT:** Because of the combined weight of the spa, water and users, it is extremely important that the base upon which the spa rests be smooth, flat, level and capable of uniformly supporting this weight, without shifting or settling, for the entire time the spa is in place. If the spa is placed on a surface which does not meet these requirements, damage to the skirt and/or the spa shell may result. Damage caused by improper support is not covered under warranty. It is the responsibility of the spa owner to assure the integrity of the support at all times. We recommend a poured, reinforced concrete slab with a minimum thickness of 4 inches (10 cm). Wood decking is also acceptable provided it is constructed so that it meets the requirements outlined above.



**WARNING:** For spas that are to rest on balconies, roofs or other platforms not specifically tied into main structural support, consult a professional Structural Engineer with experience in this type of application.

The spa must be installed in such a manner as to provide drainage away from it. Placing the spa in a depression without provisions for proper drainage could allow rain, overflow and other casual water to flood the equipment and create a wet condition in which it would sit in. For spas which will be recessed into a floor or deck, install so as to permit access to the equipment, either from above or below, for servicing. Make certain that there are no obstructions which would prevent removal of all side cabinet side panels and access to the jet components, especially on the side with the equipment bay.



**CAUTION:** If the spa is indoors or located in an enclosed area, proper ventilation should be discussed with an Engineer or authority competent enough to understand the necessary provisions needed to vent moist or heated air and air associated with chemical odors outdoors. **When the spa is in use considerable amounts of moisture will escape potentially causing mold and mildew.** This can cause health risk. Over time, this can damage certain surfaces, surroundings, and equipment.

## J-200 Export

### 4.1 Outdoor Location

In selecting the ideal outdoor location for your spa, we suggest that you take into consideration:

- The proximity to changing area and shelter (especially in colder weather).
- The pathway to and from your spa (this should be free of debris so that dirt and leaves are not easily tracked into the spa).
- The closeness to trees and shrubbery (remember that leaves and birds could create extra work in keeping the spa clean).
- A sheltered environment (less wind and weather exposure can result in lowered operation and maintenance costs).
- The overall enhancement of your environment. It is preferable not to place the spa under an unglutted roof overhang since run-off water will shorten the life expectancy of the spa cover.
- For spas that are to rest on balconies, roofs or other platforms not specifically tied into main structural support, consult a professional Structural Engineer with experience in this type of application.
- In the unlikely event that you should ever need to access or gain entry to any portion of the spa for servicing, it is highly recommended that you plan your outdoor installation to provide full access to the entire spa. Please take this into consideration when placing the spa in a deck or enclosed by a surrounding.
- Consider locating your spa away from any reflective surface or glass to prevent any damage to the synthetic skirt.
- Do not shim the spa. To ensure proper support the spa must sit flat on the intended foundation.

### 4.2 Indoor Location

For indoor installations many factors need to be considered before installing a spa indoors:



**WARNING:** In addition to maintenance of filters and water chemistry, proper ventilation is recommended to reduce the risk of contracting a waterborne illness (e.g. an infection, bacteria or virus) and/or respiratory ailments that could be present in the air or water. Consult a licensed architect or building contractor to determine your specific needs if installing your hot tub indoors.

- **Proper Foundation: Consult a Structural Engineer when considering a foundation that will adequately support the spa the entire time it is in place.** Proper support is critical especially if the spa is to rest on a second story or higher. For spas that are to rest on balconies, roofs or other platforms not specifically tied into the main structural support, you should consult a professional Structural Engineer with experience in this type of application.

- **Proper Drainage: It is extremely important to have in place measures to sufficiently handle excessive water spillage.** Be sure the flooring in which the spa rests on has adequate drainage and can handle the entire contents of the spa. Be sure to make provisions for ceilings and other structures that may be below the spa installation. Areas around your spa can become wet or moist so all flooring and subsequent furniture, walls and adjacent structures should be able to withstand or resist water and moisture.
- **Proper Ventilation: Proper ventilation should be discussed with an Engineer or authority competent enough to understand the necessary provisions needed to vent moist or heated air and air associated with chemical odors outdoors.** When the spa is in use considerable amounts of moisture will escape, potentially causing mold and mildew over time which can damage certain surfaces and/or surroundings.
- **Sufficient Access:** In the unlikely event that you should ever need to access or gain entry to any portion of the spa for servicing, it is highly recommended that you plan your indoor installation to provide full access to the entire spa.
- **Warranty:** Damage caused by not following these guidelines or any improper installation not in accordance to local codes or authorities is not covered under the spas warranty. Please consult your local state or city building ordinances.
- **Do not shim the spa.** To ensure proper support the spa must sit flat on the intended foundation.

### 5.0 General Electrical Safety Instructions

Your new Jacuzzi spa is equipped with a “state-of-the-art” equipment system. It contains the most advanced safety and self-protective equipment in the industry. Nonetheless, this spa must be installed properly to insure dependable usage. Please contact your dealer or local building department should you have any questions regarding your installation.



Proper grounding is extremely important. Jacuzzi spas are equipped with a current collector system. A pressure wire connector is provided on the surface of the control box, located outside the equipment door (Figure B, page 15) to permit connection of a bonding wire between this point and any ground metal equipment, metal water pipe or conduit within 5 feet (1.5m) of the spa, or copper clad grounding rod buried within 5 feet (1.5m) of the spa. Bonding wire must be at least No. 8 AWG (8.4 mm<sup>2</sup>) solid copper wire. This is a most important safety assurance feature. Before installing this spa, check with the local building department to insure installation conforms to local building codes.

## J-200 Export

### 6.0 Power Requirements

Jacuzzi spas are designed to provide optimum performance and flexibility of use when connected to the maximum electrical service listed below. Minor circuit board modifications can be performed to allow your new spa to accept an electrical service other than the factory operation setting.

**Note:** Refer to pages 51-52 for circuit board configuration details or contact your authorized Jacuzzi dealer.

<b>Export Models (50 Hz) Service</b>		
	<b>Single Breaker Service 1 (including Heater)*</b>	<b>Single Breaker Service 1 (including Heater)**</b>
<b>Voltage:</b>	230 VAC	230 VAC
<b>Max. Current Draw:</b>		
1-Pump System	17A	21A
2-Pump System	17A	24A
<b>Wattage:</b>		
1-Pump System:	3.9 kW	4.8 kW
2-Pump System:	3.9 kW	5.5 kW
Frequency:	50 Hz	50 Hz
Number of Wires:	3	3

**Single Breaker is the factory default.**

\* For this service, the heater **will not operate** while either jets pump is running in high speed. The service 1 breaker will include connection for all components. **Note: pump 2 runs only in high speed.**

\*\* For this service, the heater **will operate** while one jets pump is running in high speed. The service 1 breaker will include connection for all components. **Note: pump 2 runs only in high speed.**



**Export Models (50 Hz) Service**

	Dual Breaker Service 1/ Service 2***	Three Phase Service Service 1/ Service 2/Service 3****
Voltage:	230 VAC	230 VAC
<u>Max. Current Draw:</u>		
1-Pump System	12A/9A	N/A
2-Pump System	12A/16A	12A/9A/7A
<u>Wattage:</u>		
1-Pump System:	2,8kW/2,1kW	N/A
2-Pump System:	2,8kW/3,7kW	2,8kW/2,1kW/1,6kW
Frequency:	50 Hz	50 Hz
Number of Wires:	5	5

**Single Breaker is the factory default.**

\*\*\* For this service, the heater **will operate** while both jets pumps are running in high speed. The service 1 breaker will include connections for the heater and transformer. The service 2 breaker is for all other components.

**Note: pump 2 runs only in high speed.**

\*\*\*\* In this configuration, the heater **will operate** while both jets pumps are running in high speed. The service 1 breaker will include connections for the heater and transformer. Service 2 breaker is for pump 1 and other components. Service 3 breaker is for pump 2.

### 7.0 Electrical Wiring Instructions



**IMPORTANT NOTICE:** The electrical wiring of this spa must meet the requirements of the National Electrical Code/USA (NEC) and/or any applicable state or local codes. The electrical circuit must be installed by a qualified electrician and approved by a local building/electrical inspection authority.

1. **Dedicated 230V-240V models must be permanently connected (hard-wired) to the power supply.** No plug-in connections or extension cords are to be used in conjunction with the operation of this spa. Supplying power to the spa which is not in accordance with these instructions will void both the independent testing agency listing and the manufacturer's warranty.
2. The power supplied to this spa must be a dedicated circuit with no other appliances or lights sharing the power provided by the circuit.
3. To determine the current, voltage and wire size required, refer to Section 6.0 "Power Requirements" (page 12).
  - Wire size must be appropriate per NEC/USA and/or local codes.
  - The spa controller's terminal block will accept a maximum wire size of 6 AWG.
4. The electrical supply for this product must include a suitably rated switch or circuit breaker to open all ungrounded supply conductors to comply with Section 422-20 of the National Electrical Code/USA, ANSI/NFPA 70. The disconnecting means must be readily accessible to the spa's occupant but installed at least 5 feet (1.5m) from spa water.
5. The electrical circuit supplied for the spa must include a suitable ground fault circuit interrupter (GFCI) as required by NEC/USA Article 680-42.
6. The electrical supply for this product must include a suitably rated isolating switch and circuit breaker to comply with local electrical regulations. This RCD/GFCI circuit breaker must be installed at the power supply in the house electrical box.
7. For Australia/ New Zealand, the spa should be supplied through a residual current device (RCD) with a rated tripping current not exceeding 30mA (IEC 60335-2-60).
8. To gain access to the spa's power terminal block, remove the screws securing the synthetic cabinet panel under the control panel (Figure A). Then remove the control box door screws and door (Figure B).
9. Select the power supply inlet you want to use (Figure A). Feed power cable to control box, then install it through the large opening provided in the bottom side of the box.
10. Connect wires, color to color, on terminal blocks TB1 and TB3 (Figure C, page 16). **TIGHTEN SECURELY!** All wires must be hooked up securely or damage could result.
11. Install control box door and screws and reinstall the cabinet side panels.

Figure A  
Equipment Area

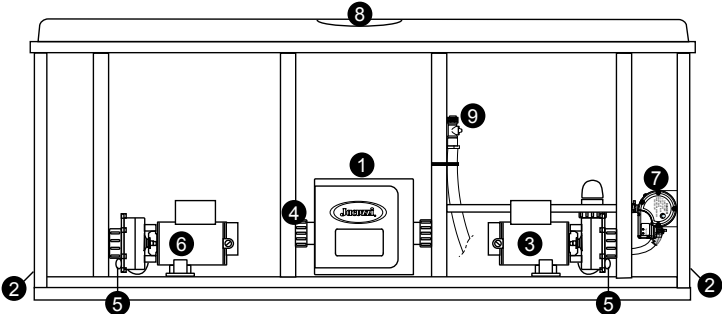

Note: Equipment location (such as pumps, CLEARRAY® system, drain, heater etc.) varies by model.

- 1. Control Box
- 2. Power Supply Inlet(s)
- 3. 2-Speed Pump
- 4. Heater
- 5. Pump Drain Plug(s)
- 6. 1-Speed Pump
- 7. CLEARRAY Water Purification System
- 8. Control Panel
- 9. Drain

Figure B Control Box

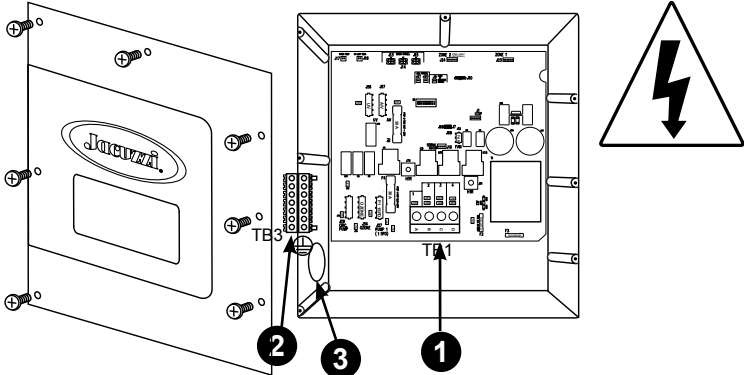

- 1. Main Terminal
- 2. Bonding Lug/Grounding Terminal
- 3. Power wires entrance (electrical fitting and conduit must be installed)

# J-200 Export

**Figure C**  
**(Export 50 Hz**  
**230 VAC Connection\*)**

**\*IMPORTANT NOTE:** Wire connections on controller board must be changed depending on the number of breakers being used, page 54.

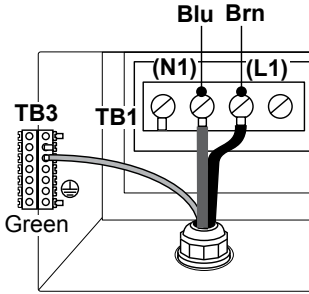

**Factory Default**

**Service 1**

- Brn (L1)
- Blu (N1)

**BREAKER TERMINAL CONNECTIONS**

L1 = All components

**Service 1**

- Blu (N1)
- Brn (L1)

**Service 2**

- Brn (L2)
- Blu (N2)

**BREAKER TERMINAL CONNECTIONS**

L1 = Heater and transformer  
L2 = All other components

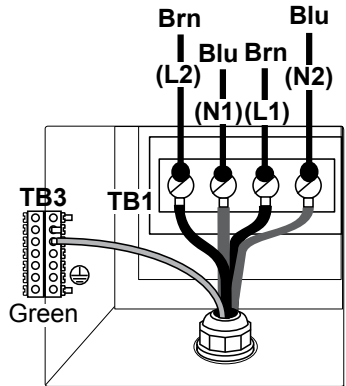

- Brn (L2)
- Blu (N1)
- Brn (L3)
- Brn (L1)

**Service 1**

- Blu (N1)
- Brn (L1)

**Service 2**

- Brn (L2)

**Service 3**

- Brn (L3)

**Note: 2-Pump models only**

**BREAKER TERMINAL CONNECTIONS**

L1 = Heater and transformer  
L2 = Pump 1 and other components  
L3 = Pump 2

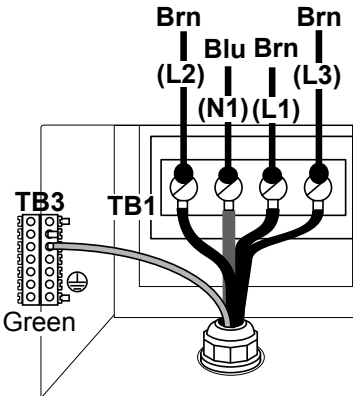

## 8.0 Spa Fill Up Procedure

For best results, read each step in its entirety before proceeding with that step.

### 1. Prepare The Spa For Filling

- Clear all debris from the spa. (Although the spa shell has been polished at the factory, you may want to treat it with a specially formulated spa cleaner.) Consult your authorized Jacuzzi dealer for additional information prior to filling spa.
- Remove filter cover, then remove filter cartridge as outlined in Section 12.1 (page 34).

### 2. Fill Spa

- Place the end of your garden hose into the empty filter bucket.

**CAUTION: TO DECREASE BUILD UP ON COMPONENTS AND MINIMIZE ACRYLIC DAMAGE.**

Never fill with water from a water softener. If your water is extremely "hard," it is preferable to fill half-way with hard water and the rest of the way with softened water. Water that is too soft can be corrosive to metal components.

-  **WARNING: TO DECREASE RISK OF INFECTION OR DISEASE.**  
Fill hot tub with clean tap water from garden hose, to reduce risk of contracting a waterborne illness (e.g. an infection, bacteria or virus) and/or respiratory ailments. Fill until water covers all jets but does not touch the bottom of the lowest headrest. (DO NOT OVERFILL!)

**IMPORTANT:** Always fill your spa through the filter bucket after draining. Failure to do so may cause air to be trapped in the pumps, preventing the pumps from circulating water. Remove the hose and replace the filter cartridge. Note: DO NOT overtighten filter cartridge, finger tight only!

### 3. Turn On Power

Turn on power to spa at the home's circuit breaker to start boot up sequence (Sec. 10.0, page 25). The heater and filter pump will automatically activate after several seconds. If the control panel flashes water temperature and "COL" or "ICE" this is normal, refer to page 46 for additional information.

### 4. Activate Jets Pumps

Turn on jets pump(s) to ensure proper mixing when adding start-up chemicals in step 5.



## J-200 Export

### 5. Add Start-Up Chemicals

Add the spa water chemicals as recommended by your authorized Jacuzzi dealer. See Section 13.0 "Water Quality Maintenance" (page 41) for general guidance.



#### **WARNING: RISK OF POISONING OR DEATH.**

Never leave chemicals opened and accessible to anyone. Use chemicals according to the vendors instructions. Always store chemicals in a safe and/or locked location. Keep away from and out of reach of children.





### 6. Establish A Stable Sanitizer Reading

Establish a stable sanitizer reading of no less than 1.0 ppm free chlorine or 2.0 ppm bromine. To ensure healthy water conditions, always maintain a constant sanitizer reading within the levels recommended on the inside cover of this manual. If sanitizer levels cannot be stabilized, perform the decontamination procedure steps 9-15 on the following page.

**Note:** The "decontamination procedure" steps 9-15 should also be used after the spa has been "Winterized" (Section 12.7, page 40) or has been sitting without power for an extended period.

### 7. Set Spa To Heat

To warm spa water to a comfortable temperature, follow these steps:

- The LCD display on the control panel displays the actual temperature of the spa water. Press either the **COOLER** (  ) or **WARMER** (  ) button once to display the "set" temperature for 5 seconds. If you want the water to heat to a different temperature, simply press **COOLER** (  ) or **WARMER** (  ) within 5 seconds. The set temperature increases or decreases by 1°F (0.5°C) each time one of these buttons is pressed.
- The heater will turn off when the temperature corresponding to the thermostat setting is achieved.

#### **Important Heater Details:**

- The maximum water temperature setting for your spa is 104°F (40°C) and the minimum setting is 65°F (18°C).
- For Export spas connected to a 20 amp service, jets pump #1 must be set to low speed and jets pump #2 must be turned off to operate the heater.
- Setting the thermostat at maximum will not accelerate the heating process. This will only result in a higher ultimate temperature.
- The heater operates until the water reaches the programmed "set temperature," then turns off. The heater will reactivate after the water cools to approximately 2°F (1°C) below the set temperature.

**8. Place Cover On Spa**

- Keeping the insulating cover in place anytime the spa is not in use will reduce the time required for heating, thereby minimizing operating costs.
- The time required for initial heat-up will vary depending on the starting water temperature.



**DANGER: RISK OF PERSONAL INJURY.**

Check water temperature carefully before entering hot tub! Excessive water temperature can cause burns, welts and body temperature to rise, hyperthermia (over-heating).

**Decontamination Procedure (Steps 9-15)**

Steps 9-15 below are only required when sanitizer levels are unstable after performing steps 1-6 above. Disregard steps 9-15 below if sanitizer levels remain stable after performing steps 1-6 above (refer to the inside cover of the manual).

9. Add 2.5 ounces of sodium dichlor for every 100 gallons of water. Refer to the table below for approximate water fill volume by model.



**CAUTION: RISK OF PERSONAL INJURY OR SPA DAMAGE!**

Never add chlorine tablets (trichlor) or acid to your hot tub for any reason! These chemicals may damage components within your hot tub, burn or irritate your skin, create a rash, and void the manufacturer warranty for your spa.

**Water Fill Volume by Model**

<b>Model</b>	<b>Average Fill Volume*</b>	<b>Sodium Dichlor</b>
J-280	460 Gal (1,741 L)	12.0 oz
J-275	420 Gal (1,590 L)	10.5 oz
J-245	360 Gal (1,363 L)	9.0 oz
J-235	360 Gal (1,363 L)	9.0 oz
J-225	354 Gal (1,340 L)	9.0 oz
J-215	220 Gal (833 L)	5.5 oz
J-210	240 Gal (908 L)	6.0 oz

\*Use average fill volume for chemical maintenance

## J-200 Export

10. Leave spa cover open during this step to allow excessive chemical vapors to exit spa, protecting pillows and plastic knobs from chemical attack. If spa is indoors, open doors and windows for proper ventilation. Turn on all jet pumps for one hour, then place the massage selector knob (if equipped) in the center “combo” position and open all air controls (Figure A is for all models except the J-210). For the J-210 models (Figure B) turn the Diverter Jet in the “combo” position.

**Note:** You will need to press the jets pump button(s) every 20 minutes since these functions have an automatic 20 minute time-out function that turns them off.

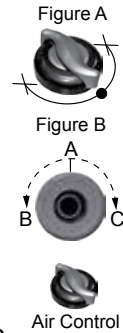

### **WARNING: RISK OF PERSONAL INJURY!**

- To decrease the risk of injury, drowning or entrapment, never leave your hot tub unattended for any reason while the cover is open and accessible, especially to small children and animals!
- Precautions should be taken to minimize your exposure to chemical vapors (that could cause lung, brain, or skin damage).

11. Turn off power to the spa at the circuit breaker, then drain spa as outlined in Section 12.2 “Draining And Refilling” (page 38).
12. Fill spa until water covers all jets but does not touch the bottom of the lowest headrest. **DO NOT OVERFILL.**

### **CAUTION: TO DECREASE BUILD UP ON COMPONENTS AND MINIMIZE ACRYLIC DAMAGE.**

Never fill with water from a water softener. If your water is extremely “hard,” it is preferable to fill half-way with hard water and the rest of the way with softened water. Water that is too soft can be corrosive to metal components.

13. Consult your authorized Jacuzzi dealer for chemical recommendations, then add chemicals to hot tub water to achieve a constant sanitizer reading within the levels recommended on the inside cover of this manual.
14. Turn on all jet pumps when adding chemicals to ensure proper mixing and leave your hot tub cover open until the sanitizer level becomes stable to protect pillows and plastic knobs from chemical attack. Refer to the inside cover of the manual.





**WARNING: RISK OF PERSONAL INJURY.**

- To decrease the risk of injury, entrapment or drowning, never leave your hot tub unattended for any reason, especially if while the cover is open and accessible to small children and animals!
- To decrease the risk of contracting a waterborne illness (e.g. an infection, bacteria or virus) and/or respiratory ailments, maintain water chemistry within 6 step parameters. If you or other bathers experience such a condition, discontinue use and seek immediate medical attention.

15. Establish a sanitizer reading no less than 1.0 ppm free chlorine or 2.0 ppm bromine, then allow the hot tub to set undisturbed for 8 hours. Retest water after 8 hours to determine if sanitizer levels are stable. If sanitizer levels are stable, your spa is ready for use. To ensure healthy water conditions, always maintain a constant sanitizer reading within the levels recommended on the inside cover of this manual. If sanitizer levels are not stable at this time, it will be necessary to repeat this procedure in its entirety (steps 1-15) until stable sanitizer readings are achieved.

**IMPORTANT:** If the **CLEARRAY®** water purification system is removed from the hot tub or is not operating effectively follow the “without **CLEARRAY®**” water chemistry parameters as defined by the Association of Pool and Spa Professionals.

16. After adequate sanitizer levels are achieved, close all spa air controls to maximize heat retention when spa is not in use.

## J-200 Export



### 9.0 Control Functions

#### 9.1 Control Panel

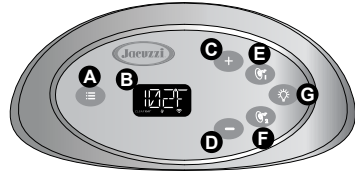
A. **Menu** (  ) **Button**: Allows access to the programming menus.





2-pump control panel shown

B. **LCD Display**: Can display current water temperature (default display), water temperature set point, selected menu functions, and error messages. Displays a **CLEARRAY** icon (  ) and heat icon (  ) when those features are on.

C. **Warmer Button** (  ) : Increases water temperature set point. Increments of 1°F or 0.5°C.

D. **Cooler Button** (  ) : Decreases water temperature set point. Increments of 1°F or 0.5°C.

E. **Jets 1 Button** (  ) : Turns jets pump #1 on and off. Press once for low speed; press a second time for high speed; press a third time to turn pump off.

F. **Jets 2 Button** (  ) : Turns high-speed jets pump #2 on and off. Press once to turn pump #2 on; press a second time to turn pump #2 off.

G. **Light Button** (  ) : Turns underwater light (if equipped) and accent lights (if equipped) on in one of three random modes or one of seven solid colors. Refer to Section 10.3 (page 26) for details.

#### Operation Details

- Temperature Adjustment: 65 to 104°F (18 to 40°C). Factory default setting is 100°F (38°C).
- LED light system: All LED lights run for 2 hour and then automatically shut off.
- Jets 1/Jets 2 Button Operation: Jets run for 20 minutes when activated, then turn off automatically to conserve energy. Simply press either jets button to continue operation for an additional 20 minutes.

9.2 General Spa Features and Controls

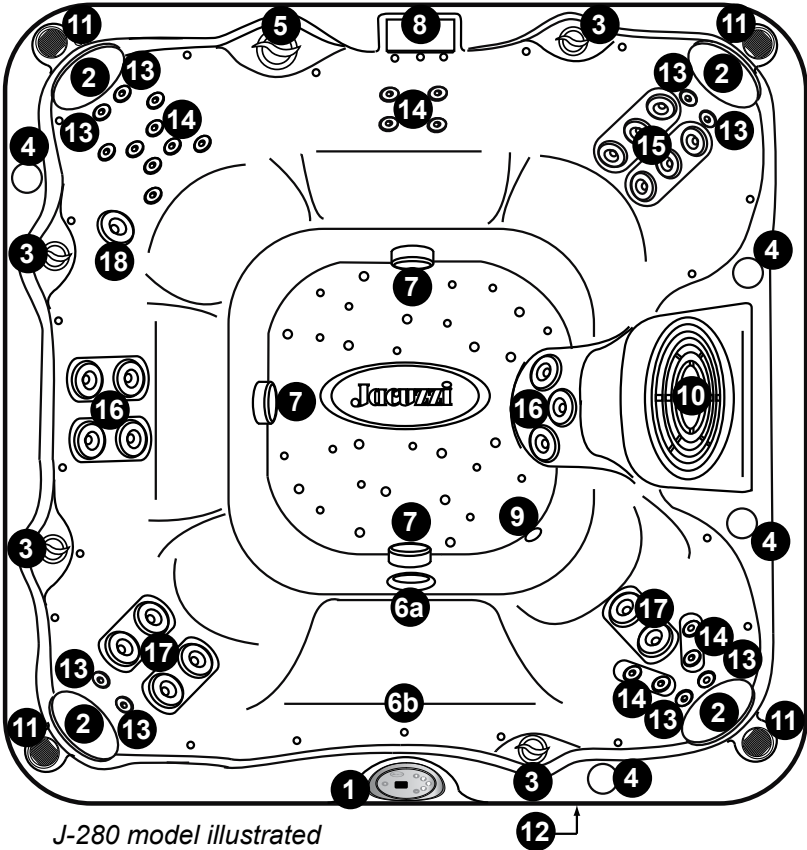

J-280 model illustrated

- |  |  |
|--|--|
| <ol style="list-style-type: none"> <li>1. Control Panel</li> <li>2. Headrest Pillows (4 ea.)</li> <li>3. Air Controls (4 ea.)</li> <li>4. Cup Holders (4 ea.)</li> <li>5. Massage Selector (1 ea.)</li> <li>6. LED Lighting System:             <ul style="list-style-type: none"> <li>• Underwater light system includes multi-color footwell light (6a.)</li> <li>• Multiple LED accents lights (6b. - qty 22 ea.)</li> </ul> </li> <li>7. Suction Fittings (protect massage selector from debris entrapment/damage)</li> <li>8. Waterfall with flow rate control lever</li> </ol> | <ol style="list-style-type: none"> <li>9. Heater Return/Gravity Drain</li> <li>10. Filter lid with one underlying filter cartridge (Filter requires periodic cleaning)</li> <li>11. Optional audio system speakers (4 ea.)</li> <li>12. Optional BLUEWAVE® Spa Stereo System</li> <li>13. Classic Direct Jets (8 ea.)</li> <li>14. Classic Euro Jets (16 ea.)</li> <li>15. Classic Mini Jets (6 ea.)</li> <li>16. Classic Luxury Jets (7 ea.)</li> <li>17. Classic Rotational Jets (6 ea.)</li> <li>18. Classic Whirl Jet (1 ea.)</li> </ol> |
|--|--|

*Specifications Subject to Change Without Notice.*

# J-200 Export

## 9.3 General Spa Features and Controls

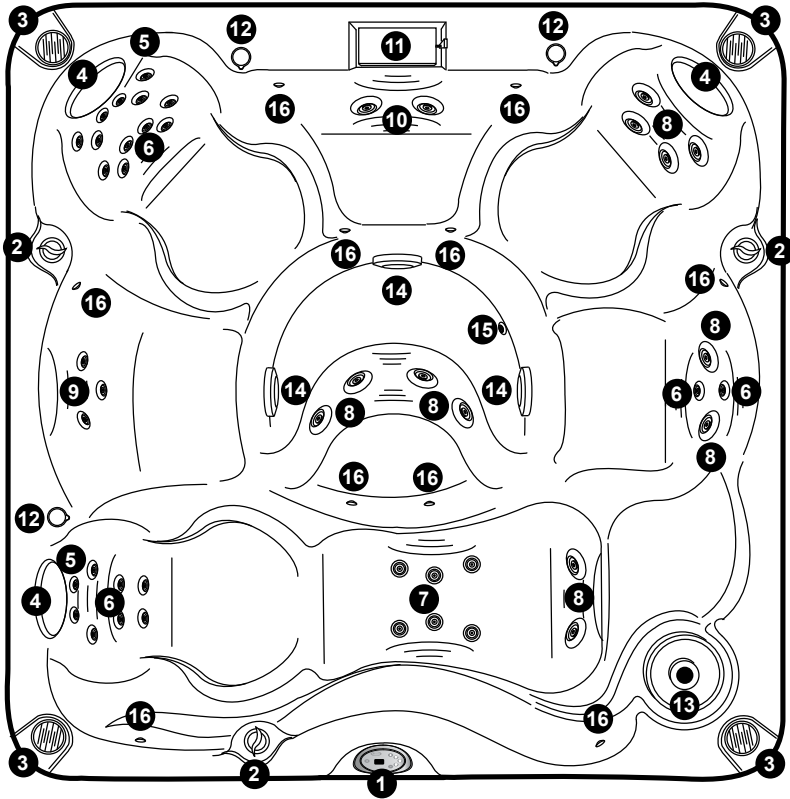

J-275 model illustrated -

Jet locations and features vary by model.

- |   |   |
|---|---|
| 1. Control Panel                          | 11. Waterfall with flow rate control lever  |
| 2. Air Controls (3 ea.)                   | 12. Cup Holders (3 ea.)   |
| 3. Optional audio system speakers (4 ea.) | 13. Filter skimmer with one underlying filter cartridge (Filter requires periodic cleaning) |
| 4. Headrest Pillows (3 ea.)               | 14. Suction Fittings (3 ea.)  |
| 5. Classic Direct Jets (8 ea.)            | 15. Heater Return/Gravity Drain   |
| 6. Classic Euro Jets (14 ea.)             | 16. LED lighting system includes multiple LED accents lights (10 ea.)                       |
| 7. Classic Pulsator Jets (6 ea.)          | 17. Optional BLUEWAVE® Spa Stereo System  |
| 8. Classic Luxury Jets (12 ea.)           |   |
| 9. Classic Mini Jets (3 ea.)              |   |
| 10. Classic Turbo (2 ea.)                 |   |

Specifications Subject to Change Without Notice.

## 10.0 Operating Instructions

The spa control system has automatic functions that operate upon start-up and normal operation to protect the system. Upon the first power up, the readout displays the following information:

1. Control panel displays all lit indicators, permitting visual inspection of all display segments and indicator lights for proper operation.
2. Control panel displays the controller and control panel software versions.
3. Control panel scrolls the message, "**WELCOME TO JACUZZI.**"

**Note:** It is common for the heater to turn on after the spa is first filled because tap water is often very cold. If water temperature, at this time, is less than the factory default temperature setting of 100°F (38°C) the heater will turn on and run until the water temperature rises to the factory setting, then turn off.

### 10.1 Setting Water Temperature

The spa's thermostat provides optimum control of water temperature. The temperature set point (set temperature) can be adjusted from 65-104°F (18-40°C). To raise the set temperature, press the **WARMER** ( + ) button. To lower the set temperature, press the **COOLER** ( - ) button. The first press of either **WARMER** ( + ) or **COOLER** ( - ) button displays the set temperature. To access the overtemp feature that allows the spa to reach 106°F (41°C) follow the steps below (Figure 10.1a).

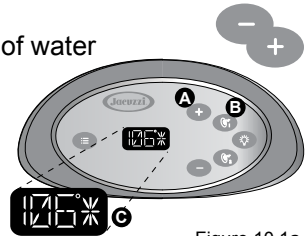



Figure 10.1a



**WARNING: RISK OF HYPERTHERMIA (OVER-HEATING) CAUSING SEVERE INJURY, BURNS, WELTS OR DEATH!**  
Water temperature in excess of 104°F (40°C) may injurious to your health.

- A. Press and hold the **WARMER** ( + ) button then;
- B. Press and hold the **JETS 1** (  ) button at the same time for 2 seconds. You will see the temperature rise to 106°F (41°C) on the LCD display. To lower the temperature, press the **COOLER** ( - ) button.
- C. When the overtemp feature has been activated, the asterisk after the last digit will flash on and off every second as an indicator for being in the overtemp mode.

**Note:** If the temperature is manually changed below 104°F (40°C) and you would like to raise the temperature to 106°F (41°C) again, you will have to repeat the steps above.

## J-200 Export

### 10.2 Activate Jets Pump

The control panel JETS 1 button activates jets pump 1. The first press activates low speed, the second press activates high speed, and the third press shuts jets pump 1 off. The JETS 2 button activates jets pump 2. The first press activates high speed, the second press turns jets pump 2 off. When manually activated, either pump will automatically turn off after 20 minutes.

### 10.3 Multi-Colored LED Light System Operation



The multi-colored LED light system offers seven constant color variations and three unique random modes for enhanced spa enjoyment. Press the Light button once to activate the first light mode, then continue pressing the button to either turn the light off or to select one of seven constant colors or random solid color mode as illustrated below.

**Note:** Anytime the spa light is manually activated, it will remain on for 2 hours then automatically shut off.

1st press	high speed blend mode
2nd press	low speed blend mode
3rd press	freezes low speed blend mode
4th press	solid Blue color
5th press	solid Violet color
6th press	solid Red color
7th press	solid Amber color
8th press	solid Green color
9th press	solid Aqua color
10th press	solid Near White color
11th press	goes back to high speed blend mode

### 10.4 Adjusting Individual Jet Flow

The water flow through certain jets in your spa can be adjusted or turned off by rotating the outside jet ring. Other jets also offer an adjustable center nozzle that allows you to change the water discharge angle. Simply tilt the center nozzle in these jets to the desired angle to customize your personal massage.



Classic Whirl Jet



Classic Pulsator Jet

**Note:** Always keep at least 6 adjustable jets open at all times to ensure proper filtration characteristics within spa.

## 10.5 Selecting Desired Massage Action

For models that incorporate a massage selector valve (Diverter Jet for J-210, Figure A) that allows you to customize the massage and performance by diverting water between various jet systems within the spa. Simply turn valve to positions A, B or C to divert water pressure to various jet groups.

**Note:** The valve is intended to operate in positions A (Combo), B, or C for optimum performance. It is considered normal for sound levels within the valve to increase between these positions due to the large amounts of water flowing through it. For optimum filtration benefits, always leave this valve in position A when the spa is covered and select positions B or C for maximum jet performance during spa use.

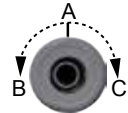

Figure A

## 10.6 Air Controls

Certain jet systems have their own air control. Each control introduces air into the water lines that supply that specific jet group. Simply turn the air control of choice counterclockwise to open or clockwise to close.



**Note:** To minimize heat loss, all air controls should be closed when the spa is not in use. Certain jets may not draw air when jets pump 1 is running in low speed; this is considered normal.

## 10.7 Optional BLUEWAVE® Spa Stereo System (J-215 to J-280)

Spas equipped with the optional Jacuzzi audio system offer enhanced enjoyment. These models include a high-quality AUX/Bluetooth stereo receiver with four high-quality marine speakers for unsurpassed sound quality and long-life.

**Note:** All operations for the BLUEWAVE system are controlled via a connected Bluetooth or Auxiliary device.



## 10.8 Blow-Out Cycle

This cycle will purge the air from the plumbing lines normally caused by draining and filling the spa. The Jets Pump 1 (low speed) will turn on for 1 minute and then shut off. Then Jets Pump 2 (if equipped) will turn on and run for 1 minute then shut off. This cycle will **only** occur at start up.

**Note:** Turning off the corresponding jets pump that is running can deactivate the feature.

## 10.9 Cleanup Cycle

The cleanup cycle occurs once per day at 12:00 PM (noon) for 2 minutes. This is not user programmable. The Jets Pump 1 (low speed) will turn on for one minute and then shut off. Then Jets Pump 2 (if equipped) will turn on and run for 1 minute then shut off.

**Note:** Turning off the corresponding jets pump that is running can deactivate the feature.

## J-200 Export

### 11.0 Menu Features and Programming Instructions

Your hot tub is equipped with menus that allow you to program additional features. By continually pressing the Menu (☰) button you will cycle through the menus as follows (Figure 11.0a):













Current temperature (Main Menu)	
Primary Filtration (page 28)	
Heat (page 29)	
Filter Change (page 30)	
UV (page 36)	
H2O (page 31)	
Time (page 31)	
Date (page 32)	
Temp (page 32)	
Language (page 32)	
Lock (page 33)	
WiFi (not available)	
Elog (End of Menu)	

Figure 11.0a

#### 11.1 Programming the Primary Filtration





During the primary filtration cycle, the pump 1 low speed and **CLEARRAY** are activated. The hot tub is programmed to cycle 4 times (every 6 hours) throughout the day, each cycle last 2 hours, and a default start time of 12:00 AM, but this can be changed.

##### A. Primary Filtration Menu







To change the programmed Primary Filtration Cycle:

**Note:** If no button is pressed within 5 seconds of each selection the screen will revert back to the Main Menu and the current settings will remain active.



1. Press  until you get to the “**PF**” Menu. The display will scroll “**PRIMARY FILTER.**” After the second scroll, if no action is taken, the system will revert back to the Main Menu.
2. Press  or  to display the current start time and prepare the system for changes.
3. Press  or  to adjust the start time, in 1-hour increments. To switch from “AM” to “PM” you must round a 12-hour period.



4. Press  to confirm and save the start time.
5. Press  or  to adjust the number of cycles per day, either 1, 2, 3, 4 or 8 cycles in a 24-hour period.
6. Press  to confirm and save the changes.
7. Press  or  to adjust the duration of the cycles, either 1, 2, or 3 hour cycles.
8. Press  to confirm and save the duration time. The system will return to the **"PRIMARY FILTER"** Menu.



In extreme bitter cold weather, where freezing can occur, we recommend you program the primary filtration cycle to run for a minimum of 8 hours per day. Refer to the "Winterizing" section on page 39.

## 11.2 Programming the Heating Mode

Your hot tub is equipped with 3 modes of heating. An automatic mode called "AUTO," where the hot tub's temperature is maintained at all times. An energy saving heating cycle called "ECO." Lastly, a mode that will only activate the heater during the daytime called "DAY" mode.

- Economy Mode is an energy savings program. The hot tub is allowed to heat between 5:00 PM and 7:00 AM every day. The hours are not programmable.
- Day Mode allows the hot tub to heat during the day, between 7:00 AM to 5:00 PM. The hours are not programmable.
- Auto Mode allows the heater to heat, at all times, in order to maintain the preset temperature.





**Note:** The heater will reactivate after the water cools to approximately 2°F (1°C) below the set temperature.

### A. Programming the Heating Mode



To change the programmed heating mode:

**Note:** If no button is pressed within 5 seconds of each selection the screen will revert back to the Main Menu and the current settings will remain active.

1. Press  until you get to the **"HEAT"** Menu. The display will scroll **"HEATER MODE."** After the second scroll, if no action is taken, the system will revert back to the Main Menu.
2. Press  or  to prepare the system for changes. Continually press to scroll through the following modes:
  - Economy Mode: The screen will display **"ECO"** and scroll **"ECONOMY MODE."**
  - Day Mode: The screen will display **"DAY"** and scroll **"DAY MODE."**
  - Auto Mode: The screen will display **"AUTO"** and scroll **"AUTO MODE."**
3. Once a selection is made, press  to confirm and activate the setting. The system will return to the **"HEATER MODE"** Menu.

## J-200 Export

### 11.3 Programming the Change Filter Timer

A programmable filter timer can be set to remind you when to clean or replace the filters.





- The default setting is for 180 days.
- The timer range is from OFF to 180 days, in increments of 10 days.

**Note:** It is not recommended that this feature be turned OFF. In order to continually maintain clean and working filters, it should be program as instructed.

#### A. Programming or resetting the timer.

**Note:** If no button is pressed within 5 seconds of each selection the screen will revert back to the Main Menu and the current settings will remain active.



1. Press  until you get to the “**FC**” Menu. The display will scroll “**FILTER CHANGE**.” After the second scroll, if no action is taken, the system will revert back to the Main Menu.
2. Press  or  to prepare the system for changes. Continually press to adjust the length of time for the timer.
3. Once you select the number of days, press  to confirm this selection. The system will return to the “**FILTER CHANGE**” Menu.
4. Once the timer expires, the display will alternate between the water temperature and “**CHANGE FILTER**”, page 47.

### 11.4 Programming the CLEARRAY® Timer

A programmable change bulb timer can be set to remind you when to when it is time to replace the UV bulb for the CLEARRAY system.





- The default setting is for 365 days.
- The timer range is from OFF to 365 days, in increments of 10 days.

**Note:** It is not recommended that this feature be turned OFF. In order to continually have the CLEARRAY system effectively preform its function, it should be program as instructed.

#### A. Programming or resetting the timer.

**Note:** If no button is pressed within 5 seconds of each selection the screen will revert back to the Main Menu and the current settings will remain active.



1. Press  until you get to the “**UV**” Menu. The display will scroll “**CLEARRAY BULB**.” After the second scroll, if no action is taken, the system will revert back to the Main Menu.
2. Press  or  to prepare the system for changes. Continually press to adjust the length of time for the timer.
3. Once you select the number of days, press  to confirm this selection. The system will return to the “**CLEARRAY BULB**” Menu.
4. Once the timer expires the display will alternate between the water temperature and “**CHANGE CLEARRAY BULB**” page 46.

### 11.5 Programming the Water Refresh Timer

A programmable water refresh timer can be set to remind you when to when it is time to drain and refill your hot tub.

- The default setting is for 180 days.
- The timer range is from OFF to 180 days, in increments of 30 days.

**Note:** It is not recommended that this feature be turned OFF. In order to continually maintain the water healthy and clean, in addition to chemical maintenance, it should be program as instructed.

#### A. Programming or resetting the timer.

**Note:** If no button is pressed within 5 seconds of each selection the screen will revert back to the Main Menu and the current settings will remain active.



1. Press until you get to the “H2O” Menu. The display will scroll “WATER REFRESH.” After the second scroll, if no action is taken, the system will revert back to the Main Menu.
2. Press or to prepare the system for changes. Continually press to adjust the length of time for the timer.
3. Once you select the number of days, press to confirm this selection. The system will return to the “WATER REFRESH” Menu.
4. Once the timer expires the display will alternate between the water temperature and “CHANGE WATER” page 47.

### 11.6 Programming the Time

To program the time, follow the steps below:

**Note:** If no button is pressed within 5 seconds of each selection the screen will revert back to the Main Menu and the current settings will remain active.

















1. Press until you get to the “TIME” Menu. The display will scroll “SET TIME.” After the second scroll, if no action is taken, the system will revert back to the Main Menu.
2. Press or to display the current time.
3. Press or to prepare the system for changes.
4. Press or to adjust and program the correct hour. Press to save the change and move on to program the minutes.
5. The current minutes will blink as an indication that it is ready. Press or to adjust and program the minutes. Press to save the change and move on to program either AM or PM.
6. The current setting will blink as an indication that it is ready. Press or to toggle between AM and PM. Once selected, press to save the change. The system will return to the “SET TIME” Menu.

## J-200 Export

### 11.7 Programming the Date

To program the date, follow the steps below:





**Note:** If no button is pressed within 5 seconds of each selection the screen will revert back to the Main Menu and the current settings will remain active.

1. Press  until you get to the “**DATE**” Menu. The display will scroll “**SET DATE.**” After the second scroll, if no action is taken, the system will revert back to the Main Menu. 
2. Press  or  and the current date will scroll. For example “**JAN 01 2016.**”
3. Press  or  to display the year.
4. Press  or  to adjust and program the correct year. Press  to save the change and move on to program the month.
5. The current month will blink as an indication that it is ready. Press  or  to adjust and program the month. Press  to save the change and move on to program the day.
6. The current day will blink as an indication that it is ready. Press  or  to scroll through the days. When the day is selected, press  to save the change. The system will return to the “**SET DATE**” Menu.

### 11.8 Programming the Temperature Format

To program the temperature format, follow the steps below:







**Note:** If no button is pressed within 5 seconds of each selection the screen will revert back to the Main Menu and the current settings will remain active.

1. Press  until you get to the “**TEMP**” Menu. The display will scroll “**TEMPERATURE FORMAT.**” After the second scroll, if no action is taken, the system will revert back to the Main Menu. 
2. Press  or  to switch between °F or °C. Once selected press  to save the change. The system will return to the “**TEMPERATURE FORMAT**” Menu.

### 11.9 Programming the Language

Your new hot tub comes with four language display options. To program the display language, follow the steps below:

**Note:** If no button is pressed within 5 seconds of each selection the screen will revert back to the Main Menu and the current settings will remain active.

1. Press  until you get to the “**LANG**” Menu. The display will scroll “**LANGUAGE MENU.**” After the second scroll, if no action is taken, the system will revert back to the Main Menu. 
2. Press  or  to display the current language.
3. Press  or  to scroll through the languages available. The choices are English, French, German and Spanish. Once a selection is made, press  to save the change. The system will return to the “**LANGUAGE MENU.**”

## 11.10 Programming the Lock Feature







You can prevent users from changing certain features of the hot tub. **It is important to realize that after either mode is enabled, there is no physical pad lock indicator on the topside control panel display to inform the user that either mode is active.** If some or all topside control panel buttons are non-responsive, either lock mode IS ENABLED. The lock modes to choose from are:

**Note:** If no button is pressed within 5 seconds of each selection the screen will revert back to the Main Menu and the current settings will remain active.

- Access Lock will disable the ability to manually activate or adjust any feature of the hot tub. All scheduled operations will still be preformed.
- Settings Lock will disable the ability to change any of the user settings. You can still activate the jet pumps and lighting. All scheduled operations will still be preformed.
- Set Temperature Lock will disable the temperature up and down buttons to prevent unauthorized temperature adjustments.

### A. Activating a lock feature.

1. Press  until you get to the “**LOCK**” Menu. The display will scroll “**LOCK MENU.**” After the second scroll, if no action is taken, the system will revert back to the Main Menu.
2. Press  or  to switch from “**AL**” (“**ACCESS LOCK**”), “**SL**” (“**SETTINGS LOCK**”) to “**TL**” (“**SET TEMPERATURE LOCK**”). Once a selection is made, press  to save the change. The system will return to the “**LOCK MENU.**”

### B. Deactivating a lock feature.

To deactivate a lock mode, press and hold  for 10 seconds.

## J-200 Export

### 12.0 Spa Maintenance

Proper and regular maintenance of your spa will help it retain its beauty and performance. Your authorized Jacuzzi dealer can supply you with all the information, supplies, and accessory products you will need to accomplish this.



#### **DANGER: RISK OF SEVERE INJURY OR DROWNING BY ENTRAPMENT!**

- Keep hair, loose articles of clothing or hanging jewelry away from suction fittings, rotating jets or other moving components to avoid entrapment that could lead to drowning or severe injury.
- Never use the spa unless all suction guards, filter, filter lid, or skimmer assembly are installed to prevent body and/or hair entrapment.
- Never operate or use the spa if the filter, filter lid, or skimmer assembly are broken or any part of the skimmer assembly is missing. Please contact your dealer or nearest service center for service.
- The suction fittings and suction covers in this spa are sized to match the specific water flow created by the pump(s). If it is necessary to replace the suction fittings, suction covers or pump(s), be sure that the flow rates are compatible and are in compliance with the VGB Safety Act, page 2.
- Never replace a suction fitting or suction cover with one rated less than the flow rate marked on the original suction fitting. Using improper suction fittings or suction covers can create a body or hair suction entrapment hazard that may lead to drowning or severe injury.
- Owners must alert all spa users to the potential risk of Hair, Limb, Body, Evisceration (disembowelment), and Mechanical Entrapment, page 6.

#### 12.1 Cleaning The Filters

**TO DECREASE DROWNING OR ENTRAPMENT, ALWAYS TURN POWER TO SPA OFF BEFORE CLEANING THE FILTER CARTRIDGE!  
J-210/J-215/J-225/J-235/J-245/J-275 Models:**

These model spas are equipped with a skimmer basket and filter cartridge located in the skimmer/filter well. Filtering is accomplished when jets pump #1 turns on in low speed initiating water flow through the skimmer basket and polyester mesh filter cartridge. As this happens, suspended particles become trapped on the filter's surface. To ensure optimum performance, it is necessary to remove and clean the skimmer basket once a week and filter cartridge once a month or sooner, depending on usage and water quality.

**To Clean Filter:**

1. Turn off power to the spa at the home's breaker panel or select the "AL" ("ACCESS LOCK") mode (page 33) to disable all spa functions.
2. Remove the filter strainer lid assembly by rotating it counterclockwise, Figure A.
3. Remove the filter cartridge by rotating it counterclockwise to unthread it from the filter wall fitting (Figure B). Then lift it straight up to remove from filter well (Figure C).
4. Using a garden hose with a high-pressure nozzle, rinse debris from the filter pleats beginning at the top and working your way downward (Figure D). Continue, one section at a time, until you have rinsed all of the filter's pleats.

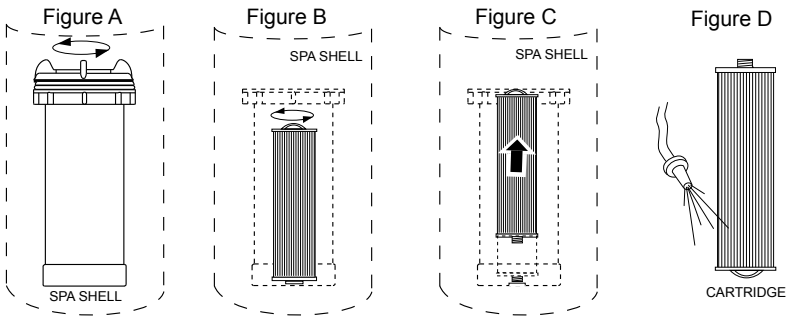

To ensure optimum performance, clean skimmer basket and filter cartridge once a month or as necessary, depending on use.

J-210 models include filters on their footwell suction covers (shown right) that prevent debris from entering the pump when operating. These filters must remain in place to protect the components from debris entrapment/damage. They should be cleaned every 2 months, or when weak pump performance is observed.

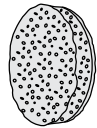

## J-200 Export

### J-280 Models:

These model spas are equipped with a skimmer bag and one high performance pleated filter cartridge located under the filter cover. Debris are filtered by drawing water through the skimmer bag and filter cartridge when jets pump 1 is running a programmed filter cycle or when manually activated by spa use. Combined, both provide unsurpassed water quality by trapping surface oils and suspended particles. The filter cartridge should be cleaned once a month or as necessary, depending on use, for optimum performance.

### J-280 Models:

Refer to steps below for complete filter cleaning/replacement instructions.

- A** ⚠ **DANGER: TURN POWER TO SPA OFF! TO DECREASE RISK OF DEATH, DROWNING, OR ENTRAPMENT, NEVER OPERATE SPA WHEN FILTER IS NOT PROPERLY INSTALLED OR IF SKIMMER ASSEMBLY IS DAMAGED OR ALTERED!** ⚠

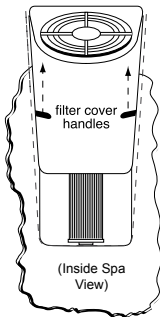

- B** Lift upward on filter skimmer cover handles to remove it from mating retainer clips.

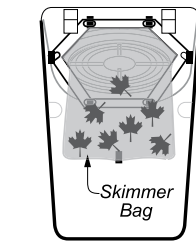

(Filter Cover Back View)

- C** Remove skimmer bag from clips, then clean out debris.

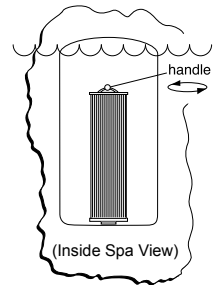

- D** Rotate filter cartridge handle counterclockwise to unthread filter cartridge from mating wall fitting.



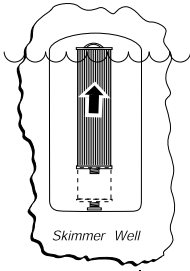

- E** Lift unthreaded filter cartridge from skimmer well.

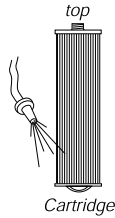

- F** Rinse debris from filter cartridge pleats using a garden hose and high-pressure nozzle. Start at the top and work downward to the handle. Repeat until all pleats are clean.

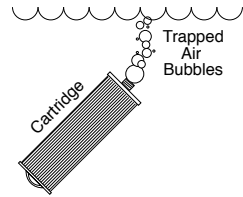

- G** Submerge filter cartridge in spa. Tilt threaded end upward to remove trapped air bubbles, then keep cartridge submerged to prevent air entrapment during installation (step H).

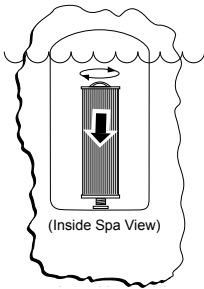

- H** Install filter cartridge back onto wall fitting by rotating the cartridge handle clockwise. **DO NOT OVERTIGHTEN!**

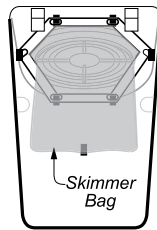

(Filter Cover Back View)

- I** Install clean skimmer bag back onto the filter cover clips as shown.

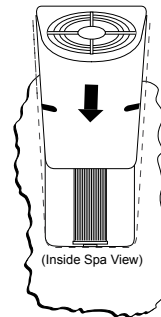

- J** Install filter cover by sliding it down into position over mating spa retainer clips. Turn spa power back on after skimmer cover is installed.

Periodically, the filter cartridge will need a more thorough cleaning to remove imbedded oils and minerals. For this, we suggest cleaning as illustrated followed by soaking the filter overnight in a plastic container filled with a solution of water and specially formulated filter cleanser available from your authorized Jacuzzi dealer. The average life expectancy of each filter is approximately two years with proper care and water quality maintenance. Replacement cartridges may be purchased from your authorized Jacuzzi dealer.

## J-200 Export

### 12.2 Draining and Refilling

About every 3 months, you will want to replace the spa's water. The frequency depends on a number of variables including the amount of use, attention paid to water quality maintenance, etc. You will know it is time for a change when you cannot control sudsing and/or you can no longer get the normal feel or sparkle to the water even though the key water balance measurements are all within the proper parameters.

**CAUTION! READ THIS BEFORE DRAINING:** To prevent damage to the spa's components, **turn off power to the spa at the circuit breaker before draining it.** Do not turn the power back on until your spa has been refilled.

**CAUTION:** There are certain precautions to keep in mind when draining your spa. If it is extremely cold, and the spa is outdoors, freezing could occur in the lines or the equipment, see "WINTERIZING" (page 40). On the other hand, if it is hot outdoors, do not leave the spa's surface exposed to direct sunlight.

To drain your spa, perform the following steps (actual drain may vary from one shown). Turn off power to spa at breaker.

1. Locate and remove the synthetic cabinet screws. The cabinet is located directly below the control panel.
2. Cut zip tie(s) and pull drain hose from equipment area (Figure A).
3. Hold drain hose above water line, then unthread drain cap (1) from hose using a counterclockwise rotation (Figure B). Place drain hose on ground to start drain, making sure to direct water away from spa. If equipped, turn valve (2) counterclockwise to open the valve (Figure C).
4. After spa is drained, reinstall drain cap on drain hose fitting until finger tight! If equipped, turn valve (2) clockwise to close the valve. **DO NOT OVERTIGHTEN!**
5. Coil drain hose up and place back inside the spa equipment bay (Fig. A).
6. Reinstall synthetic cabinet and screws, then refer to the "Spa Fill Up Procedure" (page 17).

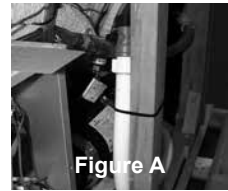

Figure A

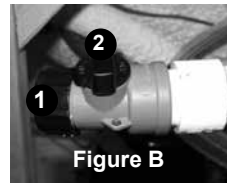

Figure B

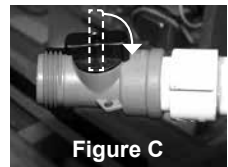

Figure C

Drain location and appearance may vary.

### 12.3 Pillow Care

Remove and clean each headrest by gently grasping both ends in each hand and pulling upward to release each pillow "snap." To reinstall, simply "snap" each pillow back into place. Clean as needed with soapy water using a cloth or soft-bristle brush. Always remove the pillows when adding chemical shock treatment to the spa water. The pillows can be returned to the spa when the sanitizer reading is stable as recommended on the inside cover of the manual.

## **12.4 Cleaning The Spa Interior**

To preserve the sheen of your spa's surface, it is crucial that you avoid using abrasive cleaners or cleaners which have adverse chemical effect on the surface. If you are not certain as to the suitability of a particular cleanser, consult your authorized Jacuzzi dealer. Regardless of the cleanser used, use extreme care to assure that no soap residue is left on the surface. This could cause severe sudsing when the spa is refilled.

## **12.5 Cover Care and Maintenance**

Certain hot tub covers distributed by Jacuzzi Hot Tubs have a vinyl or PROLAST™/PROLAST™ Extreme encasement. This vinyl or PROLAST™/PROLAST™ Extreme encasement also referred to as the cover "skin" is attractive and durable. Regular monthly cleaning and conditioning (vinyl) is strongly recommended and may increase the longevity of your cover.

### **A. To Clean and Care for the Cover**

To clean and condition the encasement (cover skin):

1. Use a garden hose to remove any debris.
2. Using a large sponge or soft bristle brush, use diluted or mild soap to gently scrub the top.
3. Rinse and clean and do not allow soap to dry on the cover. Do not use soap on the underside of the cover.
4. Please check with your Jacuzzi® Hot Tub Dealer for recommended cover care and conditioning products. Use non-petroleum based conditioners to keep the vinyl supple.
5. Do not use any solvents, abrasive cleaners or strong detergents. Do not use products that contain silicone or alcohol.

### **B. Additional Care and Maintenance Instructions:**

1. Debris can accumulate on the spa cover. Removal of snow or other debris will help to avoid breakage of the foam cores.
2. Be sure to lock the cover straps to secure the cover from unwanted or accidental entry.
3. Do not place heavy objects on the vinyl.
4. Do not walk, sit or stand on the cover.
5. Do not drag or use the flaps/skirt or the cover lock straps to remove the cover.
6. Use only recommended cover lift systems.
7. Use only chemicals and cleaners recommended by Jacuzzi.
8. Remember to keep spa covered when not in use. Maintaining proper water levels assures efficient operation and efficient electrical usage.
9. Do not expose your spa to the sun for extended periods of time as UV rays can damage the interior surface.
10. Use caution when removing cover. Before removing cover, assure all locks have been released to avoid lock breakage and or cover strap damage.

## J-200 Export

### 12.6 Maintaining The Synthetic Cabinet

Your new spa's synthetic cabinet requires little or no maintenance of any kind. To clean, simply wipe cabinet with a clean towel and mild soap solution.



**CAUTION:** Never spray cabinet with a garden hose for any reason since this action may induce an electrical short in the spa's electrical equipment.

### 12.7 Winterizing

Your Jacuzzi spa is designed to automatically protect itself against freezing when operating properly. During periods of severe freezing temperatures, you should check periodically to be certain that the electrical supply to the spa has not been interrupted. In extreme, bitter cold weather less than 32°F (0°C), program the primary filtration cycle to run for a minimum of 8 hrs per day to prevent freezing (page 28). If you do not intend to use your spa or if there is a prolonged power outage during periods of severe freezing temperatures, **it is important that all water be removed from the spa and equipment to protect against damage from freezing.**

**Expert winterization of your spa is highly recommended, contact your authorized Jacuzzi dealer.** In emergency situations, damage can be **minimized** by taking the following steps:

**CAUTION: TURN OFF POWER TO HOT TUB!**

Follow the directions on page 38 for draining the spa.

1. Turn off power to the spa.
2. As the water level drops below the seats, use whatever means necessary to get the water out of the recessed seating areas and into the footwell, such as a wet/dry vacuum.
3. Turn the massage/diverter selector(s) into the middle combo position to allow the water in the plumbing lines to drain, page 27.
4. Turn the waterfall valve to the open position to allow the water in the plumbing lines to drain, pages 23 and 24.
5. Open all the air controls and leave them open until you resume use of the spa, page 27.
6. As the water level drops below the seats, use whatever means necessary to get the water out of the recessed seating areas and into the footwell, such as a wet/dry vacuum.
7. When the water level ceases to drop, use whatever means available to remove any remaining water from the footwell, such as a wet/dry vacuum.
8. Remove the synthetic cabinet panel under the control panel and locate the drain plugs on the front of the pump(s), (Figure A, page 15). Remove plugs to allow water to drain out of pumps and heater.

**Note:** Approximately one to two gallons will be released during this procedure. Use a wet/dry vacuum or other means to keep this from flooding the equipment compartment. Replace the drain plugs.

9. Loosen hose clamp at bottom of CLEARRAY® system and pull hose off of CLEARRAY fitting (twist the hose back and forth while pulling downward). Tip hose down and allow to drain. Then reinstall hose and clamp. Remove the cover of the CLEARRAY system to access the UV bulb and quartz tube. Remove and store the UV bulb in a safe location. Remove and dry off the quartz tube then reinstall it. Depending on the length of time, consider replacing the UV bulb when you resume use of your hot tub.
  10. Re-install synthetic cabinet side panel and cover spa so that no casual moisture can enter into it.
- Consult your authorized Jacuzzi dealer if you have any questions regarding winter use or winterizing.

### **12.8 Restarting Your Spa in Cold Weather**

If you want to start up your spa after it has sat empty for a time in freezing temperatures, be aware that the water remaining in certain sections of the piping may still be frozen. This situation will block water flow preventing the spa from operating properly and possibly damaging the equipment. We recommend you consult your authorized Jacuzzi dealer for guidance before attempting to re-start your spa under these conditions.

### **13.0 Water Quality Maintenance**

To decrease the risk of contracting a waterborne illness (e.g. an infection, bacteria or virus) and/or respiratory ailments, maintain water quality within specified limits. This will enhance your enjoyment and prolong the life of the hot tub's equipment. Doing so requires regular attention because the water chemistry involved is a balance of several factors. Procrastination in regard to water maintenance will result in poor and potentially unhealthful conditions for soaking and even damage to your hot tub investment. For specific guidance on maintaining water quality, consult your Authorized Jacuzzi dealer who can recommend appropriate chemical products for sanitizing and maintaining your hot tub.



**WARNING: FAILURE TO MAINTAIN WATER QUALITY CAN RESULT IN:**

- Increase risk of contracting a waterborne illness (e.g. an infection bacteria or virus) and/or respiratory ailments.
- Damage the equipment, components and spa shell, which are not covered under the hot tub's warranty.

**CAUTION:** Never store hot tub chemicals inside the hot tub's equipment bay. The equipment bay may reach elevated temperatures, this is where high voltage electronic devices are located. This area is not intended for storage of any kind.

## J-200 Export

### 13.1 pH Control

pH is a measure of relative acidity or alkalinity of water and is measured on a scale of 0 to 14. The midpoint of 7 is said to be neutral, above which is alkaline and below which is acidic. In spa water, it is very important to maintain a slightly alkaline condition of 7.4 to 7.6. Problems become proportionately severe the further outside of this range the water gets. A low pH will be corrosive to metals in the spa equipment. A high pH will cause minerals to deposit on the interior surface (scaling).

In addition, the ability of the sanitation agents to keep the spa clean is severely affected as the pH moves beyond the ideal range. That is why almost all spa water test kits contain a measure for pH as well as the sanitizer.

### 13.2 Sanitizing

To destroy bacteria and organic compounds in the spa water, a sanitizer must be used regularly. Chlorine and bromine are the two most popular sanitizers used to date. Many other additives are available for your spa. Some are necessary to compensate for out-of-balance water, some aid in cosmetic water treatment and others simply alter the feel or smell of the water. Your authorized Jacuzzi dealer can advise you on the use of these additives. When adding spa shock (chlorine or non-chlorine) or pH balancing chemicals activate the jets pump(s) and leave the spa cover open for a minimum of 20 minutes. By doing this you will allow excessive chemical vapors to exit the spa, protecting pillows and plastic knobs from chemical attack.



#### **WARNING: RISK OF PERSONAL INJURY, DROWNING OR ENTRAPMENT!**

Never leave your hot tub unattended for any reason while the cover is open and accessible, especially to small children and animals!

#### **CAUTION: RISK OF PERSONAL INJURY OR SPA DAMAGE!**

Never add chlorine tablets (trichlor) or acid to your hot tub for any reason! These chemicals may damage components within your hot tub, burn or irritate your skin, create a rash and void the manufacturer warranty for your spa.

### 13.3 CLEARRAY® Water Purification System

CLEARRAY Water Purification System is exclusive technology utilizing natural ultraviolet technology to eliminate waterborne bacteria, viruses, and algae in portable spas. The ultraviolet light otherwise known as UV-C or germicidal light inactivates the microorganisms disrupting the DNA so that it cannot reproduce and is considered lifeless.

CLEARRAY is plumbed in-line with your filtration system. After the water is drawn from the pump, filter, and heater it is then directed through the

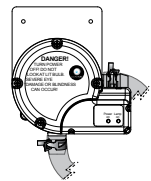

CLEARRAY system. Water passes through an ultraviolet light energy that treats and disinfects the water. The water is then pumped back into the spa giving you crystal clear water instantly. The system has a ballast that is the power supply for the purification system; it has two LED indicator lights. The “Power On” (red color) indicating incoming power and the “Lamp On” (green color) indicating the system is properly working. CLEARRAY is standard for all models.

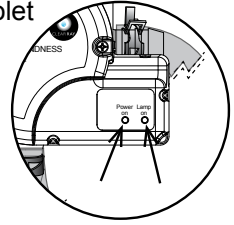

**Note:** The CLEARRAY only runs when pump 1 is on low speed for an automatic reason, a heat call or a filter cycle.

After a year the bulb must be replaced. If the UV timer has been programmed correctly a message will appear on the LCD display when the time allotted has expired. In order to clear the message a new UV bulb needs to be installed and the timer must be reset page 30).



## WARNINGS:

- Do not operate the UV-C emitter when it is removed from the appliance enclosure.
- This appliance contains a UV-C emitter.
- Unintended use of the appliance or damage to the housing may result in the escape of dangerous UV-C radiation. UV-C radiation may, even in little doses, cause harm to the eyes and skin.
- Appliances that are obviously damaged must not be operated.
- Read the maintenance instructions before opening the appliance.

### 13.4 CLEARRAY® Lamp Replacement and Quartz Tube Maintenance

**Important:** It is **MANDATORY** that the UV bulb is replaced and the quartz tube be cleaned every 12 months to maintain optimum performance.

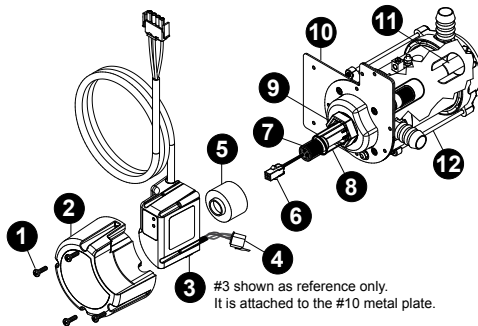

FIGURE 1



**DANGER: TURN THE SPA BREAKER TO THE OFF POSITION!**

## J-200 Export



**WARNING:** DRAIN THE SPA IF YOU ARE REPLACING OR CLEANING THE QUARTZ TUBE!



**WARNING:** ALLOW LAMP TO COOL DOWN PRIOR TO REMOVING FROM QUARTZ TUBE.



**DANGER:** NEVER LOOK AT THE LIT BULB. THIS CAN CAUSE SEVERE EYE DAMAGE OR BLINDNESS.

### UV BULB REPLACEMENT AND QUARTZ TUBE MAINTENANCE:

**Note:** Location of CLEARRAY System and connection may vary by model.

1. Turn the breaker to the spa OFF. DRAIN YOUR SPA.  
**Note:** If you are only replacing the UV bulb then the spa does not have to be drained. You will need to drain it if you are replacing or cleaning the quartz tube.
2. Once the UV bulb has cooled off remove the CLEARRAY System enclosure cover (2) by removing the four screws (1). This will expose the UV bulb and connections, Figure 2.

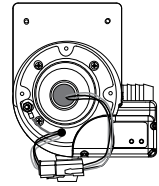

FIGURE 2



**DANGER:** NEVER REMOVE COVER WITHOUT FIRST TURNING OFF AT POWER SOURCE AND DRAINING THE SPA.

FIGURE 3

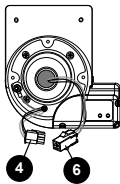

FIGURE 4

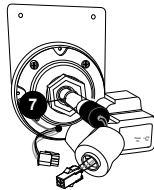

FIGURE 5

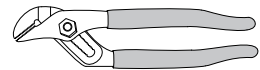
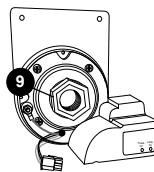

FIGURE 6

3. Disconnect UV bulb socket (6) from the power cord socket (4), Figure 3.
4. Slowly remove the UV bulb (7) out of the quartz tube, Figure 4.
5. Remove the quartz seal compression nut (9) by turning it counterclockwise, Figure 5. Use a pair of channel-lock pliers if needed, Figure 6.
6. Now you are ready to clean or replace the quartz tube (8). For cleaning the quartz tube, follow steps 7 and 8 then proceed from step 9. For replacing quartz tube, skip steps 7 and 8 and proceed from step 9.
7. **Cleaning quartz tube:** Clean the quartz tube by wiping, until clear, using a paper towel or a dry cotton cloth. If needed, a household tub and shower lime removal product can be used.



**WARNING:** Do not use abrasive cleaners as they can scratch the quartz tube surface.



8. Rinse the quartz tube with clean water to completely remove any cleaning products that were used in step 7.
9. **Replacing quartz tube:** Remove the black o-ring from the old quartz tube and place it on the new tube. Place the new quartz tube (8) into the water chamber (12) with the domed end first making sure it is inserted and seated inside the quartz end holder. Only a small portion will be exposed when it is seated correctly.
10. Reinstall and hand tighten the quartz seal compression nut (9) by turning it **clockwise**.
11. Refill your spa.
12. **System Test 1:** Assure there is no water dripping from the seal compression nut (9). If water is visible, STOP and tighten the compression nut (9) using a pair of channel lock pliers to a maximum of 1/4 turn. If that does not fix the leak, then repeat quartz tube maintenance process from step 1 through step 11. Make sure there is no water leaking before proceeding to step 13.
13. **System Test 2:** Reconnect the CLEARRAY unit to the controller. Turn breaker back ON. Turn on the pump to circulate the water through the CLEARRAY System. Wait for 5 minutes and assure no water is dripping. If water is visible, STOP, fix the leak by repeating quartz tube maintenance process from step 1 through step 12. **Make sure there is no water visible. Turn the pump and breaker OFF BEFORE proceeding to step 14.**
14. Reconnect the UV bulb socket (6) to the power cord socket (4) make sure you use the latex glove provided when handling the UV bulb.



**WARNING: DO NOT TOUCH THE NEW UV BULB WITH YOUR BARE HAND.** Oil on your skin will cause hot spot on the UV bulb and shorten the life of your UV bulb. Use the provided latex glove to handle the UV bulb.

15. Slide the new UV bulb (7) back inside the quartz tube.
16. Reinstall the black bulb boot (5) back over the quartz seal compression nut (9).
17. Reinstall the enclosure cover (2) and secure with the screws.
18. Properly dispose of the old UV bulb.



**WARNING:** This CLEARRAY System includes a UV bulb, which contains mercury. Dispose of the bulb in accordance with disposal laws. See [www.lamprecycle.org](http://www.lamprecycle.org).

19. Once power is activated you can check the ballast, Figure 7, to see if the CLEARRAY System is functioning. The power on (red) light indicates that the CLEARRAY System is being provided power and should always be on. The lamp on (green) light indicates that UV bulb is activated.

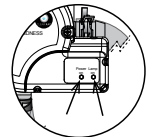

**FIGURE 7**

## J-200 Export

### 14.0 Error Conditions/Error Messages

Your spa has a self-diagnostic control system. The system will automatically display the following if a problem is detected. **Always insist on genuine Jacuzzi replacement parts.**

#### 14.1 Panel Displays COOL



Cool Condition - Temperature has dropped 20°F (11°C) below the current set temperature. The Jets Pump 1 and the heater have been activated to bring the temperature within 15°F (8°C) of the set temperature. No corrective action is required!

**Note:** This condition is common during first time fill ups or during refills since tap water is often very cold.

#### 14.2 Panel Displays ICE



Freeze Protection - A potential freeze condition has been detected. No action is required. Water temperature is below 55°F (12.78°C). Jets Pump 1 and Jets Pump 2 will activate for 10 minutes, then turn off. Then the Jets Pump 1 and the heater will activate for 10 minutes. The two cycles shall repeat until the water temperature reaches 65°F (18.33°C). See "Winterizing" (page 40).

#### 14.3 Panel Displays SN--1

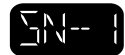

Open sensor (heater is disabled) or shorted sensor (spa is deactivated). The high-limit temperature sensor is not functioning. Contact your authorized Jacuzzi dealer or qualified service technician. The display will alternate between "SN--1", scrolling message "HI-LIMIT SENSOR ERROR" and the current water temperature.

#### 14.4 Panel Displays SN--2

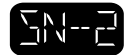

Open or shorted sensor (heater disabled). The temperature sensor is not functioning. Contact your authorized Jacuzzi dealer or qualified service technician. The display will alternate between "SN--2", scrolling message "WATER SENSOR ERROR" and the current water temperature.

#### 14.5 Panel Displays Change CLEARARRAY Bulb

The CLEARARRAY bulb timer has expired. UV bulb needs to be replaced. The display will alternate between the current temperature reading and the scrolling message "CHANGE CLEARARRAY BULB" as long as the error exists. The countdown timer for the UV bulb needs to be reset (page 30). A new UV bulb can be purchased from a local Jacuzzi dealer.

**14.6 Panel Displays Change Filter**

The filter change timer has expired. The spa filters need to be cleaned or replaced. The display will alternate between the current temperature reading and the scrolling message **“CHANGE FILTER”** as long as the error exists. The countdown timer for the Change Filter feature needs to be reset (page 30). New filters can be purchased from a local Jacuzzi dealer.

**14.7 Panel Displays Change Water**

The water refresh timer has expired. The spa needs to be drained and refilled. The display will alternate between the current temperature reading and the scrolling message **“CHANGE WATER”** as long as the error exists. The countdown timer for the Change Water feature needs to be reset (page 31).

**14.8 Panel Displays FL--1**

An **“FL--1”** display means the flow switch is malfunctioning open, the filter cartridge is excessively dirty or an “air lock” condition has occurred at the Jets Pump 1 intake. The spa heater will deactivate and Jets Pump 1 may also deactivate. Contact your authorized Jacuzzi dealer or qualified service technician. The display will alternate between **“FL--1,”** scrolling message **“FLOW ERROR OPEN”** and the current water temperature.



**14.9 Panel Displays FL--2**

An **“FL--2”** display means the flow switch is malfunctioning closed. The spa heater will deactivate and Jets Pump 1 may also deactivate. Make sure to clean the filter(s) and correct proper water level before contacting your dealer or service organization. The display will alternate between **“FL--2,”** scrolling message **“FLOW ERROR CLOSED”** and the current water temperature.



**14.10 Panel Displays FL--3**

An **“FL--3”** display means the flow switch is behaving erratically. The spa heater will deactivate and Jets Pump 1 may also deactivate. Contact your authorized Jacuzzi dealer or qualified service technician. The display will alternate between **“FL--3,”** scrolling message **“FLOW ERROR TOGGLE”** and the current water temperature.



## J-200 Export

### 14.11 Panel Displays OH



**WARNING: RISK OF HYPERTHERMIA (OVER-HEATING)  
CAUSING SEVERE INJURY, BURNS, OR WELTS.**

Water temperature is above acceptable limits. **DO NOT ENTER SPA!** Water temperature has reached 112°F (44°C).



The Jets Pump 1 has activated to circulate water through heater. Contact your authorized Jacuzzi dealer or qualified service technician. The display will alternate between “**OH**” and the current water temperature.

**Note:** As a safety measure, the red lights of the spa will flash on and off as an indication that the spa is in an overheat condition.

#### To correct condition:

- Remove the spa’s cover and allow your spa to cool down.
- Program the heater settings for Economy Mode (page 29).
- If the condition persists, contact your authorized Jacuzzi dealer.

### 14.12 Panel Displays (-- -- -- --)



**WARNING: RISK OF HYPERTHERMIA (OVER-HEATING)  
CAUSING SEVERE INJURY, BURNS, OR WELTS.**

Water temperature is above acceptable limits. **DO NOT ENTER SPA!** The safety “Watchdog” software has been triggered and the spa is deactivated. A problem has been



detected which could cause damage to the spa or its components. The display will alternate between “-- -- -- --” and the scrolling message “**WATCHDOG CALL FOR SERVICE**” as long as the error exists.

Contact your authorized Jacuzzi dealer or qualified service technician.

**Note:** As a safety measure, the red lights of the spa will flash on and off as an indication that the spa is in watchdog condition.

## **15.0 Troubleshooting Procedures**

In the event your Jacuzzi spa is not working the way it should, please first review all the installation and operating instructions in this manual and check the message on the panel display. If you are still not satisfied it is working properly, please follow the appropriate troubleshooting instructions below.

**Note:** If any of the supply cords to the accessories are damaged, they must be replaced by authorized service personnel. Contact your authorized Jacuzzi dealer or qualified service technician. **Always insist on genuine Jacuzzi replacement parts.**

### **15.1 None of the Components Operate (e.g. Pump, Light)**

Check the following:

1. Is there power to the spa?
2. Is the household circuit breaker tripped?
3. Contact your authorized Jacuzzi dealer or qualified service technician.

### **15.2 Pump Does Not Operate But Light Does**

Press the JETS 1 button:

1. If no water movement is detected, make sure power is going to the spa and check the water level. If it does not solve the problem, contact your authorized Jacuzzi dealer or qualified service technician.
2. The main jets pump 1 operates but no water flows to jets. Check the following:
  - Jets may all be closed in spa. Verify all jets are in the open “on” position (Sec. 10.5, page 26).
  - Pump may not be properly primed. This can happen after the spa is drained and refilled. Press the JETS 1 button on the control panel several times, never leaving the motor running for more than 5 to 10 seconds at a time. Turn power off and let the air out of spa plumbing system by removing the filter cartridge (Sec. 12.1, page 34). Make certain you reinstall the filter cartridge before turning on spa power and restarting the jets pump 1.

### **15.3 Poor Jet Action**

1. Make sure jets are in the full open “on” position (page 26).
2. Press the JETS 1 button to make certain pump #1 is on.
3. Open all air controls to their full on position (counterclockwise).
4. Check for dirty filter. Clean, if necessary (Section 12.1, page 34).

### **15.4 Water is Too Hot**

Reduce thermostat setting.

## ***J-200 Export***

### **15.5 No Heat**

1. Check thermostat setting.
2. Keep the spa cover in place while heating.
3. Check the settings to see if your spa is in economy heating mode (page 29).

Should checking the above steps fail to correct the problem, please call your dealer so that they may arrange service. We build the best spas in the industry. Nonetheless, we are always striving to improve the quality and features of our products.

Your input as a Jacuzzi spa owner is a cherished part of this process. If you have any comments or suggestions, or if you wish to be informed on any new products for your spa, please write to us.

**CONGRATULATIONS** on your good taste and welcome to the happiest and most relaxed family in the world!



# J-200 Export

## 16.2 Export 50 Hz 1-Pump Models

This wiring diagram is used for all 1-Pump 230V 50 Hz Export spa models.

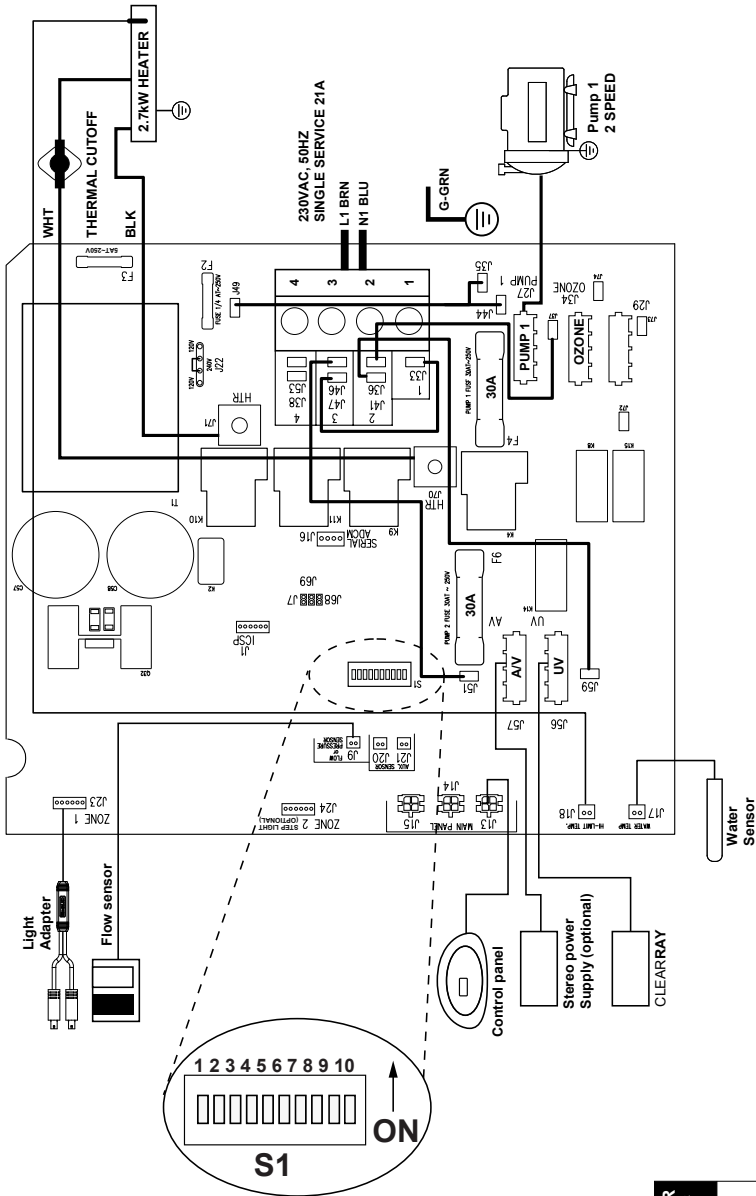

**DANGER**  
RISK OF SHOCK OR  
ELECTROCUTION!



Turn power off. This task should only be performed by a qualified technician.



## 17.0 Dip Switch Settings and Wiring

### 17.1 Switch settings for Export 50Hz Models

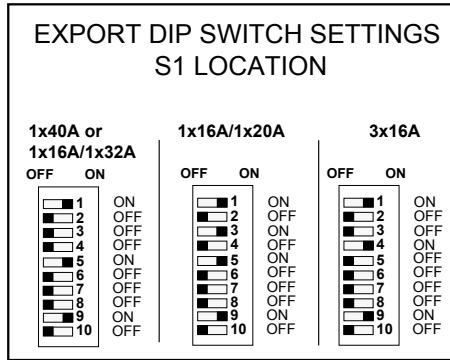
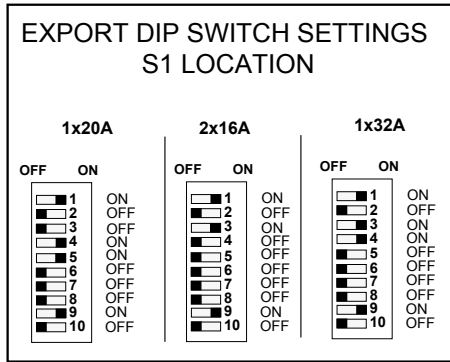

BREAKER	DIP SWITCH NUMBER									
	1	2	3	4	5	6	7	8	9**	10
1x20A (Default)	ON	OFF	OFF	ON	ON	OFF	OFF	OFF	ON	OFF
2x16A	ON	OFF	ON	OFF	OFF	OFF	OFF	OFF	ON	OFF
1x32A	ON	OFF	ON	ON	OFF	OFF	OFF	OFF	ON	OFF
1x40A or 1x16A/1x32A	ON	OFF	OFF	OFF	ON	OFF	OFF	OFF	ON	OFF
1x16A/1x20A	ON	OFF	ON	OFF	ON	OFF	OFF	OFF	ON	OFF
3x16A	ON	OFF	OFF	ON	OFF	OFF	OFF	OFF	ON	OFF

**\*\*Dip switch #9 must be ON for a 2-pump model**

**\*\*Dip switch #9 must be OFF for a 1-pump model**

# J-200 Export

## Single Service (default setting)

- 1x20A **(J210/J215/J225 Only)** This setting will turn the heater off any time the pump is running in high speed.
- 1x32A This setting is for all two pump model spas. Both pumps and the heater will be allowed to operate at the same time.

## Dual Service

- 2x16A **(J210/J215/J225 Only)** Both the jets pump and the heater will be allowed to operate at the same time.
- 1x16A/1x20A This setting is for all two pump model spas. Both pumps and the heater will be allowed to operate at the same time.

## Three Phase Service

- 3x16A This setting is for all two pump model spas. Both pumps and the heater will be allowed to operate at the same time.

### 17.3 Single Service 50Hz Connection

Wiring for export models with a single service breaker. The jumper wiring is shown below. The included extra White wire (1\*) **must** be installed.

ALL MODELS		
Single Service Jumper Wiring		
Wire	From	To
1*	J33	J47
2	J59	J41
3	J37	J36
4	J46	J51
*Extra connection must be made		

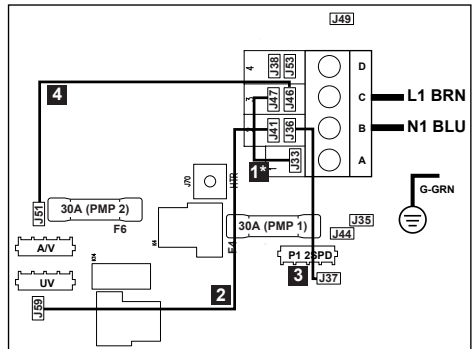

### BREAKER TERMINAL CONNECTIONS

L1 = All components

**17.4 Dual Service 50Hz Connection**

Wiring for export models with dual service breakers. The jumper wiring is shown below.

<b>ALL MODELS</b>		
Dual Service Jumper Wiring		
Wire	From	To
1	J33	J51
2	J59	J38
3	J37	J53

**BREAKER TERMINAL CONNECTIONS**

L1 = Heater and transformer  
L2 = All other components

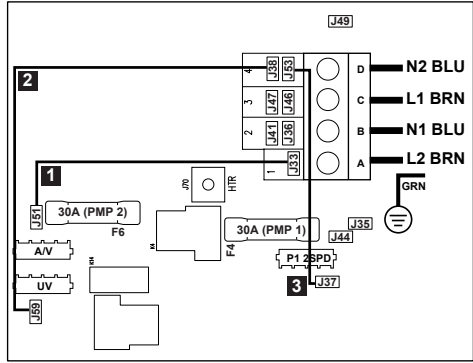

**17.5 Three Service 50Hz Connection**

Wiring for export models with a three service breaker. The jumper wiring is shown below.

<b>ALL MODELS</b>		
Three Service Jumper Wiring (except the J210, J215 and J225)		
Wire	From	To
1	J38	J51
2	J59	J41
3	J37	J36

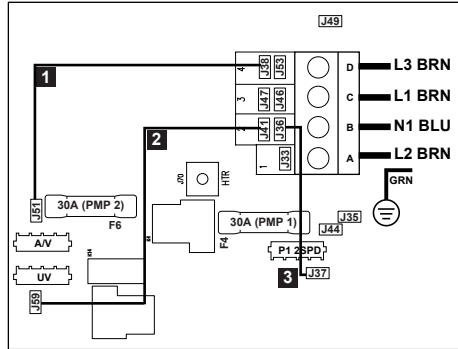

**BREAKER TERMINAL CONNECTIONS**

L1 = Heater and transformer  
L2 = Pump 1 and other components  
L3 = Pump 2

## J-200 Export

### 18.0 Optional BLUEWAVE® Spa Stereo System

To start enjoying your new stereo receiver, please read the following operation instructions in their entirety.

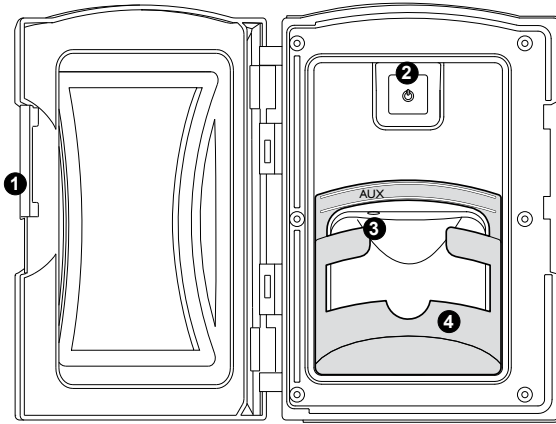

- 1. Media Locker Handle**  
Slide the handle to lock and unlock the protective door.
- 2. Power Button**  
Press power button once to turn “ON” stereo system. Press a second time to place the stereo in “Standby” mode and the red light will remain illuminated.
- 3. Auxiliary Input Jack Connector**  
Allows you to connect an auxiliary device by using a 3.5 mm cable.
- 4. Device Holding Base**  
The removable base securely holds the Auxiliary device, such as an iPod®/MP3/iPhone, in place. It can be removed for larger devices.



#### **WARNING: RISK OF ELECTRICAL SHOCK HAZARD**

**EXISTS AND EQUIPMENT DAMAGE!** Never install or remove electrical devices (AUX/Bluetooth) while hands are wet or while sitting partially or fully immersed in the spa!

**CAUTION:** Never leave electrical devices in the Media Locker when spa is not in use to prevent damage from outdoor elements! Never spray Media Locker with a pressurized water hose for any reason! Damage to the device or spa stereo system caused by water intrusion is not covered under the manufacturer’s warranty! Damage to Media Locker port or electrical devices due to excessive force or improper alignment during installation or removal from Media Locker is not covered under warranty.

**18.1 Electronic Device Connections and Functions**

**A. Connecting Your Auxiliary Device Using the 3.5 mm Cable (purchased separately):**

1. Plug one end of the cable to “Aux” connection on the stereo, Figure A.
2. Plug the other end of the cable into the head phone jack connection on the Auxiliary device.
3. When the stereo detects an audio signal from the Auxiliary device it will begin to play.
4. All operations are conducted via the Auxiliary device.

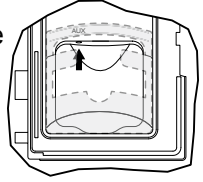

Figure A



**CAUTION: RISK OF ELECTRICAL SHOCK OR EQUIPMENT DAMAGE!**



Never install, remove or operate any electrical device (AUX/ Bluetooth) while hands are wet or while sitting partially or fully immersed in the spa!

**B. Connecting Your Bluetooth Device:**

1. Turn power “ON” to the stereo unit.
2. From your Bluetooth device, make sure the Bluetooth setting is “ON.”
3. Follow the pairing instructions for your Bluetooth device and connect to the “BLUEWAVE” device that appears on your screen.
4. If asked for a password, enter the code “0000.”
5. All operations are conducted via the Bluetooth device.

## J-200 Export

### 18.2 Stereo Cautions

-  **CAUTION** - Risk of Electric Shock. Do not leave compartment door open.”
-  **CAUTION** - Risk of Electric Shock. Replace components only with identical components.”
- “Do not operate the audio/video controls while inside in the spa.”
-  **WARNING** - Risk of Electrocution. Do not connect any auxiliary components (for example cables, additional speakers, headphones, additional audio/video components, etc.) to the system.”
- These units are not provided with an outdoor antennae; when provided, it should be installed in accordance with Article 810 of the National Electrical Code, ANSI/NFPA 70.
- Do not service this product yourself as opening or removing covers may expose you to dangerous voltage or other risk of injury. Refer all servicing to qualified service personnel.
- When the power supply connections or power supply cord(s) are damaged; if water is entering the audio/video compartment or any electrical equipment compartment area; if the protective shields or barriers are showing signs of deterioration; or if there are signs of other potential damage to the unit, turn off the unit and refer servicing to a qualified service personnel.
- This unit should be subjected to periodic routine maintenance (for example, once every 3 months) to make sure that the unit is operating properly.





