

OWNER'S MANUAL

J-300™ Series



J - 315
J - 325
J - 335
J - 345
J - 355
J - 365
J - 375

2530-398W Rev. A



Attention New Spa Owner!

Congratulations on the purchase of your new Jacuzzi® spa! The following is a list of automated functions performed by your spa. These functions are listed below in an attempt to alleviate any operational concerns you may have during the first 24-hours of ownership! Also listed below are important maintenance recommendations you should observe on a regular basis to protect your new investment.

Automated Operations

Approximately two minutes after power is applied to the spa, the first filtration/heating cycle turns on pump 1. An automatic five minute “blow-out” function also activates pump 2 for a period of five minutes to flush all lines. Then, after five minutes, pump 2 turns off and pump 1 continues to operate for the duration of the cycle.

Note: This function only occurs during the first filtration/heating cycle each day.

Maintain Healthy Spa Water

Always maintain your spa’s water chemistry within the following parameters as defined by the Association of Pool and Spa Professionals/USA:

pH	7.4-7.6
Free Chlorine	3.0-4.0 ppm
Free Bromine	2.0-4.0 ppm
Total Alkalinity	100-120 ppm
Calcium Hardness	150-250 ppm

 **TO DECREASE RISK OF INFECTION OR DISEASE!** Always maintain your spas filter as outlined below to ensure healthy spa water. Refer page 36 “Water Quality Maintenance” for additional information.

Required Filter Maintenance

Your new spa is equipped with an advanced water filtration system that provides unsurpassed water quality! To ensure maximum water quality at all times, you should clean both filter cartridges every month, or earlier as necessary. See page 30 for detailed filter cartridge cleaning/replacement instructions.

Required Water Replacement

 **TO DECREASE RISK OF INFECTION OR DISEASE!** You should replace the spa’s water every 3 months. The frequency depends on a number of variables including frequency of use, number of users, and attention paid to water quality maintenance. You will know it is time for a change when you cannot control sudsing and/or you can no longer get the normal feel or sparkle to the water, even though the key water balance measurements are all within the proper parameters. See page 36 for additional information.

Table of Contents

1.0	Important Spa Owner Information.....	1
2.0	FCC Notice	1
3.0	Important Safety Instructions for all Spa Owners	2
3.1	Entrapment Risk	6
3.2	Hyperthermia	7
3.3	Important Additional CSA Safety Instructions (Canada Only).....	8
3.4	General Electrical Safety Instructions.....	8
4.0	Choosing A Location.....	9
4.1	Outdoor Location	10
4.2	Indoor Location	10
5.0	General Electrical Safety Instructions.....	12
6.0	Power Requirements.....	12
7.0	Electrical Wiring Instructions.....	15
8.0	Spa Fill Up Procedure	18
9.0	Control Functions.....	23
9.1	Control Panel	23
9.2	General Spa Features And Controls.....	24
10.0	Operating Instructions	25
10.1	Setting Water Temperature	25
10.2	Activate Jet Pumps.....	25
10.3	Light On/Off Button.....	26
10.4	Light Mode Button.....	26
10.5	Jets	26
10.6	Selecting Desired Massage Action	27
10.7	Waterfall Feature	27
10.8	Air Controls.....	27
10.9	Optional Audio System (J-335 to J-375).....	27
11.0	Automatic Filtration Cycles	28
11.1	Standard Filtration/Heating Modes (F0-F3).....	28
11.2	Economy Filtration/Heating Modes (F4-F6).....	28
11.3	Lock Modes (L1-L2).....	28
11.4	Selecting The Filtration/Heating Mode.....	28
12.0	Spa Maintenance	30
12.1	Cleaning The Filters.....	30
12.2	Draining and Refilling.....	33
12.3	Pillow Care.....	34
12.4	Cleaning The Spa Interior.....	34

J-300 Series

12.5	Maintaining the Cover.....	34
12.6	Maintaining The Synthetic Cabinet.....	34
12.7	Winterizing.....	35
12.8	Restarting Your Spa in Cold Weather.....	36
13.0	Water Quality Maintenance.....	36
13.1	pH Control.....	36
13.2	Sanitizing.....	37
13.3	CD Ozone Water Maintenance System.....	37
14.0	Error Conditions/Error Messages.....	38
14.1	Summer Logic.....	38
14.2	Panel Displays COL.....	38
14.3	Panel Displays ICE.....	38
14.4	Panel Displays SN1.....	38
14.5	Panel Displays SN2.....	38
14.6	Panel Flashes FL1 or FL2.....	39
14.7	Panel Displays OH.....	39
14.8	Panel Displays (- - -).....	39
15.0	Troubleshooting Procedures.....	40
15.1	None of the Components Operate (e.g. Pump, Light).....	40
15.2	Pump Does Not Operate But Light Does.....	40
15.3	Poor Jet Action.....	40
15.4	Water is Too Hot.....	40
15.5	No Heat.....	41
16.0	Circuit Board Diagrams.....	42
16.1	North American J-335, J-345, J-355, J-365 and J-375 Dedicated Power Models (60 Hz).....	42
16.2	North American J-315 and J-325 Convertible Power Models (60 Hz).....	43
16.3	Export J-335, J-345, J-355, J-365 and J-375 Models (50 Hz).....	44
16.4	Export J-315 and J-325 Models (50 Hz).....	45
17.0	Optional Stereo Receiver Functions.....	46
17.1	Stereo Receiver Control Functions.....	46
17.2	Stereo Audio Receiver Specifications.....	54
17.3	CD/MP3/WMA folder/file hierarchy.....	55
17.4	Stereo Audio Receiver Troubleshooting.....	57
17.5	Standard Wireless Remote Control Functions.....	58
17.6	Optional iPod®/MP3 Player Connection.....	60
17.7	Wireless Remote Battery Replacement Procedure.....	61

1.0 Important Spa Owner Information

Your Jacuzzi® J-300 Series spa is constructed to the highest standards and is capable of providing many years of trouble-free use. However, because heat retentive materials are utilized to insulate the spa for efficient operation, an uncovered spa surface directly exposed to sunlight and high temperatures for an extended period is subject to permanent damage. Damage caused by exposing the spa to this abuse is not covered under warranty. We recommend that you always keep the spa full of water when it is exposed to direct sunlight and that you keep the Jacuzzi premium insulating cover in place at all times when the spa is not in use. Read and carefully follow the requirements for your spa's support base found in Section 4.0 titled, "Choosing A Location" (page 9).

Jacuzzi constantly strives to offer the finest spas available, therefore modifications and enhancements may be made which affect the specifications, illustrations and/or instructions contained herein.

2.0 FCC Notice

This equipment has been tested and found to comply with the limits for a Class B Digital Device, pursuant to Part 15 of the FCC Rules. These limits are designed to provide reasonable protection against harmful interference in a residential installation. This equipment generates, uses and can radiate radio frequency energy and, if not installed and used in accordance with the instructions, may cause harmful interference to radio communications. However, there is no guarantee that interference will not occur in a particular installation. If this equipment does cause harmful interference to radio or television reception, which can be determined by turning the equipment off and on, the user is encouraged to try to correct the interference by one or more of the following measures:

1. Rearrange or relocate the receiving antenna.
2. Increase the separation between the equipment and receiver.
3. Connect the equipment into an outlet on a circuit different from the circuit connected.
4. Consult the dealer or an experienced radio/TV technician for help. Changes or modifications not expressly approved by the party responsible for FCC compliance could void the user's authority to operate this equipment.

3.0 Important Safety Instructions for all Spa Owners

READ AND FOLLOW ALL INSTRUCTIONS CAREFULLY!

This spa was manufactured to meet the standards and specifications outlined in the "Virginia Graeme Baker Pool and Spa Safety Act" (VGB Safety Act). When installing and using this spa, basic safety precautions should always be followed, including:

1.  **DANGER: RISK OF SEVERE INJURY OR DROWNING!**
 - Extreme caution must be exercised to prevent unauthorized access by children.
 - To avoid accidents, ensure that children do not use this spa unless supervised at all times. Adult supervision is a critical safety factor in preventing children from drowning.
 - Use the straps and clip tie downs to secure the spa cover when not in use. This will help discourage unsupervised children from entering the spa. Keep the spa cover secure in high-wind conditions.
 - There is no representation that the cover, clip tie-downs, or actual locks will prevent access to the spa.

2.  **DANGER: RISK OF SEVERE INJURY OR DROWNING!**
 - Keep hair, loose articles of clothing or hanging jewelry away from suction fittings, rotating jets or other moving components to avoid entrapment that could lead to drowning or severe injury.
 - Never use the spa unless all suction guards, filter, filter lid, or skimmer assembly are installed to prevent body and/or hair entrapment.
 - Never operate or use the spa if the filter, filter lid, or skimmer assembly are broken or any part of the skimmer assembly is missing. Please contact your dealer or nearest service center for service.
 - The suction fittings and suction covers in this spa are sized to match the specific water flow created by the pump(s). If it is necessary to replace the suction fittings, suction covers or pump(s), be sure that the flow rates are compatible and are in compliance with the VGB Safety Act.
 - Never replace a suction fitting or suction cover with one rated less than the flow rate marked on the original suction fitting. Using improper suction fittings or suction covers can create a body or hair suction entrapment hazard that may lead to drowning or severe injury.

3.  **DANGER: RISK OF SEVERE INJURY FROM ELECTRIC SHOCK OR DEATH FROM ELECTROCUTION!**
 - Install the spa at least 5 feet (1.5m), from all metal surfaces. As an alternative, a spa may be installed within 5 feet of metal surfaces if each metal surface is permanently connected (bonded) by a minimum No. 8 AWG (8.4 mm²) solid copper conductor attached to the wire connector on the grounding lug, inside the equipment compartment on the equipment box.
 - A grounding wire connector is provided on this unit to connect a minimum No. 8 AWG (8.4 mm²) solid copper conductor between this

unit and any metal equipment, metal enclosures of electrical equipment, metal water pipe, or conduit within 5 feet (1.5m) of the unit.

- Never permit any electrical appliance, such as a light, telephone, radio, television, etc. within 5 feet (1.5m) of a spa unless such appliances are built-in by the manufacturer.
- Never bring any electrical appliances into or near the spa.
- Never operate any electrical appliances from inside the spa or when you are wet.
- The electrical supply for this product must include a suitably rated switch or circuit breaker to open all ungrounded supply conductors to comply with section 422-20 of the National Electrical Code/USA, ANSI/NFPA 70. The disconnecting means must be readily accessible and visible to the spa occupant but installed at least 5 feet (1.5m), from the spa.
- The electrical circuit supplied for the hot tub must include a suitable ground fault circuit interrupter (GFCI) as required by NEC Article 680-42.

4.  **WARNING: RISK OF SEVERE INJURY OR DEATH!**

- Extreme caution must be exercised to prevent diving or jumping into the spa or slipping and falling, which could result in unconsciousness, drowning, or serious injury. Remember that wet surfaces can be very slippery.
- Never stand, walk or sit on the top railing of the spa.

5.  **WARNING: RISK OF HYPERTHERMIA (OVER-HEATING) CAUSING SEVERE INJURY, BURNS, WELTS OR DEATH!**

- Water temperature in excess of 104°F (40°F) may be injurious to your health.
- Refer to Section 3.2 Hyperthermia for specific causes and symptoms of this condition.
- The water in the spa should never exceed 104 °F (40 °C). Water temperatures between 100 °F (38 °C) and 104 °F (40 °C) are considered safe for a healthy adult.
- Lower water temperatures are recommended for young children (children are especially sensitive to hot water) and when spa use may exceed 10 minutes.
- The Consumer Products Safety Commission/USA has stated that the water temperature in a spa should not exceed 104 °F (40 °C).
- Always test the spa water temperature before entering the spa. The user should measure the water temperature with an accurate thermometer since the tolerance of water temperature-regulating devices may vary as much as +/- 5 °F (2 °C).

6.  **WARNING: RISK OF SEVERE INJURY OR DEATH!**

- Since excessive water temperatures have a high potential for causing fetal damage during the early months of pregnancy, if pregnant or possibly pregnant, consult your physician before using a spa.
- Pregnant or possibly pregnant women should limit spa water temperatures to 100 °F (38 °C).

- Persons suffering from obesity or a medical history of heart disease, low or high blood pressure, circulatory system problems, diabetes, infectious diseases or immune deficiency syndromes should consult a physician before using a spa.
- If you experience breathing difficulties in association with using or operating your spa, discontinue use and consult your physician.
- Persons using medication should consult a physician before using a spa since some medication may induce drowsiness, while other medication may affect heart rate, blood pressure, and circulation.
- Persons suffering from any condition requiring medical treatment, the elderly, or infants should consult with a physician before using a spa.
- The use of alcohol, drugs, or medication before or during spa use may lead to unconsciousness with the possibility of drowning.

7.  **WARNING: RISK OF SEVERE INJURY OR DEATH!**

- Prolonged immersion in a spa may be injurious to your health.
- Observe a reasonable time limit when using the spa. Exposures at higher temperatures can cause high body temperature (over-heating). Symptoms may include dizziness, nausea, fainting, drowsiness, and reduced awareness. These effects could possibly result in drowning or serious injury.
- Never use a spa immediately following strenuous exercise. Enter and exit the spa slowly. Wet surfaces can be slippery.

8.  **WARNING: TO DECREASE RISK OF INFECTION OR DISEASE!**

- To reduce the risk of contracting a waterborne illness (e.g. an infection, bacteria or virus) and/or respiratory ailments, maintain water chemistry within the parameters listed on the inside cover of this manual and consult with a licensed engineer regarding proper ventilation if installed indoors or in an enclosed area.
- People with infectious diseases should not use a spa to avoid water contamination, which could result in spreading infections to others.
- Always shower before and after using your spa. Maintain water chemistry in accordance with manufacturer's instructions. Failure to do so may result in contracting a waterborne illness (e.g. an infection, bacteria or virus).

9. **CAUTION: TO DECREASE RISK OF PRODUCT DAMAGE.**

- Maintain water chemistry in accordance with manufacturer's instructions.
- Proper chemical maintenance of spa water is necessary to maintain safe water and prevent possible damage to spa components.

10. **NOTE:**

This spa is not intended nor designed to be used in a commercial or public application. The spa buyer shall determine whether there are any code restrictions on the use or installation of this spa since local code requirements vary from one locality to another.

Hot Tub Safety Literature

To ensure you have a safe and enjoyable hot tub experience, learn all you can about hot tub safety and emergency procedures. Especially useful are the brochures listed below:

- Children Aren't Waterproof
- Pool and Spa Emergency Procedures For Infants and Children
- Layers of Protection
- The Sensible Way to Enjoy Your Spa or Hot Tub

The Association of Pool and Spa Professionals publishes these brochures. To acquire a brochure:

- Ask your hot tub dealer (they may have copies)
- Go to <http://apsp.org>
- Conduct your own search on the internet
- Write to the following address:

The Association of Pool and Spa Professionals
2111 Eisenhower Avenue
Alexandria VA 22314
703.838.0083

3.1 Entrapment Risk

The Consumer Products Safety Commission/USA has reported that users of pools and spas have become entrapped (stuck) to drain and/or suction fittings causing death, drowning, or serious injury (see diagram below). This spa was manufactured to meet the standards and specifications outlined in the "Virginia Graeme Baker Pool and Spa Safety Act" (VGB Safety Act). Entrapment risk can be minimized if proper precautions are taken.



DANGER: RISK OF PERSONAL INJURY OR DEATH!

Never operate the spa if a suction fitting, suction cover, filter, filter lid or skimmer assembly are broken, damaged or missing.

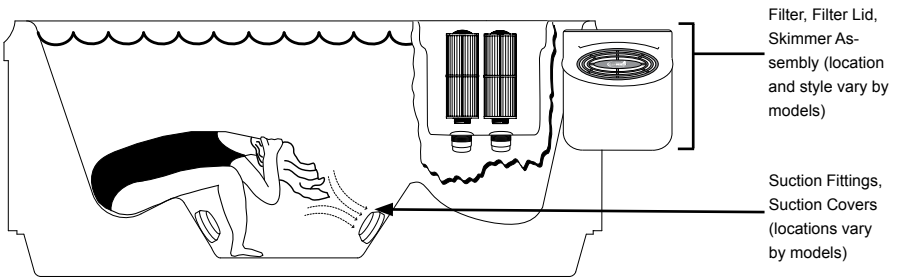



- 1.  DANGER: RISK OF SEVERE INJURY OR DROWNING!**

Hair entrapment: May occur if hair is entangled, knotted or snagged in a drain suction or skimmer assembly. This has been reported in persons who when submerge themselves underwater, allowing hair to come close and/or within the reach of the suction fittings, suction covers or skimmer assembly.

 - Keep hair away from suction fittings, suction covers, filter, filter lid or skimmer assembly.
 - Children are at risk for hair entrapment if swimming under water.
 - Never allow children to play or get near the suction fittings, suction covers, filter, filter lid or skimmer assembly.
- 2.  DANGER: RISK OF SEVERE INJURY OR DROWNING!**

Limb entrapment: May occur when a limb becomes entrapped, inserted or sucked into a suction or outlet opening.

 - Always keep suction fittings, suction covers, filter, filter lid or skimmer assembly in place when operating to avoid limb entrapment.
 - Never allow children to play or get near the suction fittings, suction covers, filter, filter lid or skimmer assembly.

3.  **DANGER: RISK OF SEVERE INJURY OR DROWNING!**
Body entrapment: May occur when part of the torso becomes entrapped, inserted or sucked into a suction or outlet opening.
- Never allow children to play or get near the suction fittings, suction covers, filter, filter lid or skimmer assembly.
4.  **DANGER: RISK OF SEVERE INJURY OR DROWNING!**
Evisceration (disembowelment) entrapment: May occur when the buttocks becomes entrapped, inserted or sucked into a suction or outlet opening.
- Never sit on suction fittings, suction covers, filter, filter lid or skimmer assembly.
 - Never allow children to play or get near the suction fittings, suction covers, filter, filter lid or skimmer assembly.
5.  **DANGER: RISK OF SEVERE INJURY OR DROWNING!**
Mechanical entrapment: May occur when jewelry, swimsuit, or hair accessories become entangled, knotted or snagged in a drain suction or skimmer assembly.
- Never allow your jewelry, swimsuit, or hair accessories to come close to the suction fittings, suction covers or skimmer assembly.
 - Never allow children to play or get near the suction fittings, suction covers, filter, filter lid or skimmer assembly.

3.2 Hyperthermia

Prolonged immersion in hot water may induce hyperthermia (overheating). The use of alcohol or drugs can greatly increase the risk of fatal hyperthermia in spas. A description of the causes, symptoms, and effects of hyperthermia are as follows:

Hyperthermia occurs when the internal temperature of the body reaches a level several degrees above the normal body temperature of 98.6 °F (37 °C). The symptoms of hyperthermia include drowsiness, lethargy (fatigue), and an increase in the internal temperature of the body (feeling of being too hot). The effects of hyperthermia include:

- Unawareness of impending hazard;
- Failure to perceive heat;
- Failure to recognize the need to exit spa;
- Physical inability to exit spa;
- Fetal damage in pregnant women; and
- Unconsciousness and DANGER of drowning.

A Warning Sign is provided in your warranty packet. Please install at a location near your spa, where it is visible to users of the spa. For additional or replacement Warning Signs please contact your local Jacuzzi dealer and reference item number #6530-082.

3.3 Important Additional CSA Safety Instructions (Canada Only)

When using this electrical equipment, basic safety precautions should always be followed, including the following:

1. **READ AND FOLLOW ALL INSTRUCTIONS.**
2. A green colored terminal or a terminal marked G, Gr, Ground, Grounding or the  symbol* is located inside the supply terminal box or compartment. To reduce the risk of electric shock, this terminal must be connected to the grounding means provided in the electric supply service panel with a continuous copper wire equivalent in size to the circuit conductors that supply this equipment (*IEC Publication 417, Symbol 5019).
3. At least two lugs marked “Bonding Lugs” are provided on the external surface or on the inside of the supply terminal box/ compartment. To reduce the risk of electric shock, connect the local common bonding grid in the area of the spa to these terminals with an insulated or bare copper conductor not smaller than No. 6 AWG (10 mm²).
4. All field installed metal components such as rails, ladders, drains or other similar hardware within 10 feet (3m) of the spa shall be bonded to the equipment grounding buss with copper conductors not smaller than No. 6 AWG (10 mm²).
5. **SAVE THESE INSTRUCTIONS.**

3.4 General Electrical Safety Instructions

Your new Jacuzzi® spa is equipped with a “state-of-the-art” equipment system. It contains the most advanced safety and self-protective equipment in the industry. Nonetheless, this spa must be installed properly to ensure dependable usage. Please contact your local Jacuzzi dealer or local building department should you have any questions regarding your installation.

Proper grounding is extremely important. Jacuzzi spas are equipped with a current collector system. A pressure wire connector is provided on the surface of the control box, located outside the equipment door (Figure B, page 17) to permit connection of a bonding wire between this point and any ground metal equipment, metal water pipe or conduit within 5 feet (1.5m) of the spa, or copper clad grounding rod buried within 5 feet (1.5m) of the spa. Bonding wire must be at least No. 8 AWG (8.4 mm²) solid copper wire. This is a most important safety assurance feature. Before installing your spa, check with your local building department to insure installation conforms to local building codes.

4.0 Choosing A Location

IMPORTANT: Because of the combined weight of the spa, water and users, it is extremely important that the base upon which the spa rests be smooth, flat, level and capable of uniformly supporting this weight, without shifting or settling, for the entire time the spa is in place. If the spa is placed on a surface which does not meet these requirements, damage to the skirt and/or the spa shell may result. Damage caused by improper support is not covered under warranty. It is the responsibility of the spa owner to assure the integrity of the support at all times. We recommend a poured, reinforced concrete slab with a minimum thickness of 4 inches (10 cm). Wood decking is also acceptable provided it is constructed so that it meets the requirements outlined above.



WARNING: For spas that are to rest on balconies, roofs or other platforms not specifically tied into main structural support, consult a professional Structural Engineer with experience in this type of application.

The spa must be installed in such a manner as to provide drainage away from it. Placing the spa in a depression without provisions for proper drainage could allow rain, overflow and other casual water to flood the equipment and create a wet condition in which it would sit in. For spas which will be recessed into a floor or deck, install so as to permit access to the equipment, either from above or below, for servicing. Make certain that there are no obstructions which would prevent removal of all side cabinet side panels and access to the jet components, especially on the side with the equipment bay.



CAUTION: If the spa is indoors or located in an enclosed area, proper ventilation should be discussed with an Engineer or authority competent enough to understand the necessary provisions needed to vent moist or heated air and air associated with chemical odors outdoors. **When the spa is in use considerable amounts of moisture will escape potentially causing mold and mildew.** This can cause health risk. Over time, this can damage certain surfaces, surroundings, and equipment.

4.1 Outdoor Location

In selecting the ideal outdoor location for your spa, we suggest that you take into consideration:

- The proximity to changing area and shelter (especially in colder weather).
- The pathway to and from your spa (this should be free of debris so that dirt and leaves are not easily tracked into the spa).
- The closeness to trees and shrubbery (remember that leaves and birds could create extra work in keeping the spa clean).
- A sheltered environment (less wind and weather exposure can result in lowered operation and maintenance costs).
- The overall enhancement of your environment. It is preferable not to place the spa under an unguttered roof overhang since run-off water will shorten the life expectancy of the spa cover.
- For spas that are to rest on balconies, roofs or other platforms not specifically tied into main structural support, consult a professional Structural Engineer with experience in this type of application.

4.2 Indoor Location

For indoor installations many factors need to be considered before installing a spa indoors:

- **Proper Foundation: Consult a Structural Engineer when considering a foundation that will adequately support the spa the entire time it is in place.** Proper support is critical especially if the spa is to rest on a second story or higher. For spas that are to rest on balconies, roofs or other platforms not specifically tied into the main structural support, you should consult a professional Structural Engineer with experience in this type of application.
- **Proper Drainage: It is extremely important to have in place measures to sufficiently handle excessive water spillage.** Be sure the flooring in which the spa rests on has adequate drainage and can handle the entire contents of the spa. Be sure to make provisions for ceilings and other structures that may be below the spas installation. Areas around your spa can become wet or moist so all flooring and subsequent furniture, walls and adjacent structures should be able to withstand or resist water and moisture.
- **Proper Ventilation: Proper ventilation should be discussed with an Engineer or authority competent enough to understand the necessary provisions needed to vent moist or heated air and air associated with chemical odors outdoors.** When the spa is in use considerable amounts of moisture will escape, potentially causing mold and mildew over time which can damage certain surfaces and/or surroundings.

- **Sufficient Access:** In the unlikely event that you should ever need to access or gain entry to any portion of the spa for servicing, it is highly recommended that you plan your indoor installation to provide full access to the entire spa.
- **Warranty:** Damage caused by not following these guidelines or any improper installation not in accordance to local codes or authorities is not covered under the spas warranty. Please consult your local state or city building ordinances.



WARNING: In addition to maintenance of filters and water chemistry, proper ventilation is recommended to reduce the risk of contracting a waterborne illness (e.g. an infection, bacteria or virus) and/or respiratory ailments that could be present in the air or water. Consult a licensed architect or building contractor to determine your specific needs if installing your hot tub indoors.

5.0 General Electrical Safety Instructions

Your new Jacuzzi® spa is equipped with a “state-of-the-art” equipment system. It contains the most advanced safety and self-protective equipment in the industry.

Nonetheless, this spa must be installed properly to insure dependable usage. Please contact your dealer or local building department should you have any questions regarding your installation.

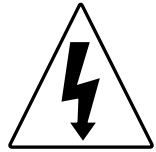

Proper grounding is extremely important. Jacuzzi spas are equipped with a current collector system. A pressure wire connector is provided on the surface of the control box, located outside the equipment door (Figure B, page 17) to permit connection of a bonding wire between this point and any ground metal equipment, metal water pipe or conduit within 5 feet (1.5m) of the spa, or copper clad grounding rod buried within 5 feet (1.5m) of the spa. Bonding wire must be at least No. 8 AWG (8.4 mm²) solid copper wire. This is a most important safety assurance feature. Before installing this spa, check with the local building department to insure installation conforms to local building codes.

120/240 Volt Convertible Models

A spa connected to a 120 VAC electrical service must be located close enough to a grounded, grounding-type electrical outlet so that the included 10 feet (3m) power cord can be plugged directly into it. **DO NOT USE AN EXTENSION CORD** as this could cause damage to the spa’s equipment due to insufficient voltage. The power supplied to this spa must be a dedicated circuit with no other appliances or lights sharing the power provided by the circuit.

6.0 Power Requirements

Jacuzzi® spas are designed to provide optimum performance and flexibility of use when connected to the maximum electrical service listed below. Minor circuit board modifications can be performed to allow your new spa to accept an electrical service other than the factory operation setting.

Note: Refer to pages 42-45 for circuit board configuration details or contact your authorized Jacuzzi dealer.

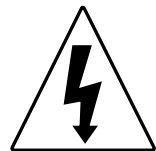

North American J-335, J-345, J-355, J-365 and J-375 Models (60 Hz)

	<u>240V/40A*</u>	<u>240V/50A**</u>	<u>240V/60A***</u>
Circuit Breaker (2-Pole):	40A	50A	60A
Number of Wires:	3	3	3
Frequency:	60 Hz	60 Hz	60 Hz
Current Draw:	26A	36A	45A

* In 40A configuration, the heater **will not operate** while either jets pump is running in high speed. **Note: pump 2 runs only in high speed.**

** In 50A configuration, the heater **will not operate** while both jets pumps are running in high speed. **This is the factory setting.** **Note: pump 2 runs only in high speed.**

*** In 60A configuration the heater **will operate** while both jets pumps are running in high speed.

North American J-315 and J-325 Convertible Models (60 Hz)

	<u>120V/15A†</u>	<u>240V/30A†</u>	<u>240V/40A‡</u>
Circuit Breaker:	15A, 1-Pole	30A, 2-Pole	40A, 2-Pole
Number of Wires:	3 (15A GFCI Cord US Only*)	4 (Hard Wire Only)	4 (Hard Wire Only)
Frequency:	60 Hz	60 Hz	60 Hz
Current Draw:	12A	21A	30A

* **All Canadian spas must be hard wired per CSA Canadian standards (page 8).**

† In 15A/30A configuration, the heater **will not operate** while the jets pump is running in high speed. **The factory setting is 120V/15A.**

‡ In 40A configuration, remove jumper JP1-2 on the board, to allow the heater **to operate** while the jets pump is running in high speed.

‡ **Caution (For 4-wire 240 VAC Heater Operation):** Move the red wire on the main terminal strip (TB1) from position #1 to position #3. Make certain wires are connected exactly as shown in Figure D (Page 17) before applying power. Failure to do so will result in damage to the circuit board and/or related components and void the manufactures warranty.

J-300 Series

Export J-335, J-345, J-355, J-365 and J-375 Models (50 Hz)

	<u>230V/20A*</u>	<u>230V/30A**</u>	<u>230V/40A***</u>
Circuit Breaker:	20A	30A	40A
Number of Wires:	3	3	3
Frequency:	50 Hz	50 Hz	50 Hz
Current Draw:	15A	23A	29A

* In 20A configuration, the heater **will not operate** while either jets pump is running in high speed. **This is the factory setting. Note: pump 2 runs only in high speed.**

** In 30A configuration, the heater **will operate** while one jets pump is running in high speed. **Note: pump 2 runs only in high speed.**

*** In 40A configuration the heater **will operate** while both jets pumps are running in high speed.

Export J-315 and J-325 Models (50 Hz)

	<u>230V/20A*</u>	<u>230V/30A**</u>
Circuit Breaker:	20A	30A
Number of Wires:	3	3
Frequency:	50 Hz	50 Hz
Current Draw:	15A	21A

* In 20A configuration, the heater **will not operate** while the jets pump is running in high speed. **This is the factory setting.**

** In 30A configuration, the heater **will operate** while one jets pump is running in high speed.

7.0 Electrical Wiring Instructions

IMPORTANT NOTICE: The electrical wiring of this spa must meet the requirements of the National Electrical Code/USA (NEC) and any applicable state or local codes. The electrical circuit must be installed by a qualified electrician and approved by a local building/ electrical inspection authority.

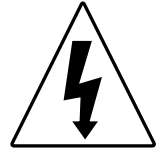

1. Convertible 120/240V Power Models:

-  **DANGER: TO DECREASE THE RISK OF SHOCK, PRODUCT DAMAGE OR ELECTRICAL FIRE.**

120V “Plug-in” Operation: This spa must operate on the supplied 10 foot (3m) GFCI cord at its original length or must be hard-wired for longer runs. **NEVER USE AN EXTENSION CORD FOR ANY REASON!**

- Convertible 120/240V Operation: The included 120V GFCI cord must be discarded for 240V operation. This spa must be hard wired. Supplying power to either configuration above which is not in accordance with these instructions will void both the independent testing agency listing and the manufacturer’s warranty.
2. Dedicated 240V models must be permanently connected (hard-wired) to the power supply. No plug-in connections or extension cords are to be used in conjunction with the operation of this spa. Supplying power to the spa which is not in accordance with these instructions will void both the independent testing agency listing and the manufacturer’s warranty.
 3. The power supplied to this spa must be a dedicated circuit with no other appliances or lights sharing the power provided by the circuit.
 4. To determine the current, voltage and wire size required, refer to Section 6.0 “Power Requirements” (page 12).
 - Wire size must be appropriate per NEC/USA and/or local codes.
 - We recommend type THHN wire.
 - All wiring must be copper to ensure proper connections. **Do not use aluminum wire.**
 5. When using wire larger than #6 (10 mm²), add a junction box near the spa and reduce to short lengths of #8 (8.4 mm²) wire to connect to the spa.
 6. The electrical supply for this product must include a suitably rated switch or circuit breaker to open all ungrounded supply conductors to comply with Section 422-20 of the National Electrical Code/USA,

ANSI/NFPA 70. The disconnecting means must be readily accessible to the spa's occupant but installed at least 5 feet (1.5m) from spa water.

- The electrical circuit supplied for the spa must include a suitable ground fault circuit interrupter (GFCI) as required by NEC/USA Article 680-42.
- To gain access to the spa's power terminal block, remove the screws securing the synthetic cabinet panel under the control panel (Figure A). Then remove the four control box door screws and door (Figure B).
- Select the power supply inlet you want to use (Figure A). Feed power cable to control box, then install it through the large opening provided in the bottom side of the box.
- Connect wires, color to color, on terminal blocks TB1 and TB3 (Figure C, page 17). TIGHTEN SECURELY! All wires must be hooked up securely or damage could result.
- Install control box door and screws and reinstall the cabinet side panels.

Figure A
Equipment Area

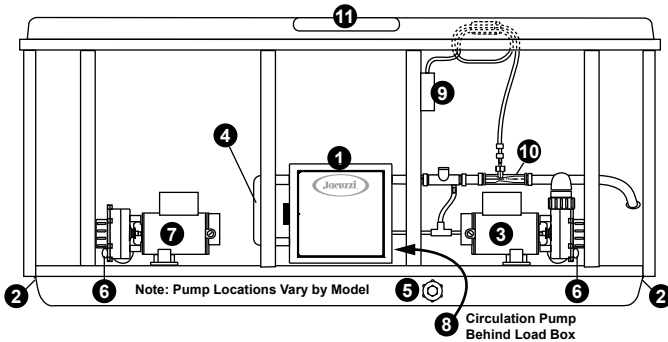

- | | |
|-----------------------------|---|
| 1. Control Box | 7. 1-Speed Jet Pumps #2 |
| 2. Power Supply Entrance(s) | 8. Circulation Pump |
| 3. 2-Speed Jets Pump #1 | 9. Optional CD Ozonator (Purchase Separately) |
| 4. Heater | 10. Factory Installed Ozone Injector |
| 5. Spa Drain Valve | 11. Control Panel |
| 6. Pump Drain Plugs(s) | |

Figure B Control Box

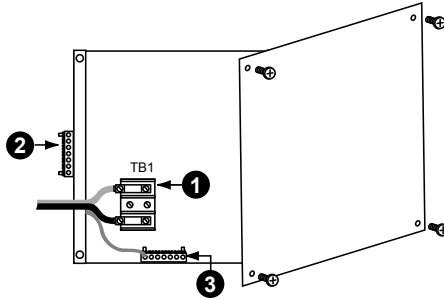

1. Terminal Block
2. Bonding Lug
3. Grounding Terminal

<p>Figure-C</p>	<p>Figure-D</p>
<p>North American Convertible Models: 120 VAC, 3-Wire Connection 60 Hz</p>	<p>North American Convertible Models: 240 VAC, 4-Wire Connection 60 Hz</p>
<p>◆ Caution (For 4-wire 240 VAC Heater Operation): Move the red wire on the main terminal strip (TB1) from position #1 to position #3. Make certain wires are connected exactly as shown in Figure D before applying power. Failure to do so will result in damage to the circuit board and/or related components and void the manufacturers warranty.</p>	
<p>Figure-E</p>	<p>Figure-F</p>
<p>North American 240V Models: 240 VAC, 3-Wire Connection 60 Hz</p>	<p>All Export Models: 230 VAC, 3-Wire Connection 50 Hz</p>

8.0 Spa Fill Up Procedure

For best results, read each step in its entirety before proceeding with that step.

1. Prepare The Spa For Filling

- Clear all debris from the spa. (Although the spa shell has been polished at the factory, you may want to treat it with a specially formulated spa cleaner.) Consult your authorized Jacuzzi dealer for additional information prior to filling spa.
- Remove filter cover, then remove filter cartridge as outlined in Section 12.1 (page 30).

2. Fill Spa

- Place the end of your garden hose into the empty filter bucket.

CAUTION: TO DECREASE BUILD UP ON COMPONENTS AND MINIMIZE ACRYLIC DAMAGE.

Never fill with water from a water softener. If your water is extremely “hard”, it is preferable to fill half-way with hard water and the rest of the way with softened water. You may fill entirely with hard water if you use a special water additive available from your Jacuzzi dealer.

-  **WARNING: TO DECREASE RISK OF INFECTION OR DISEASE.**

Fill hot tub with clean tap water from garden hose, to reduce risk of contracting a waterborne illness (e.g. an infection, bacteria or virus) and/or respiratory ailments. Fill until water covers all jets but does not touch the bottom of the lowest headrest. (DO NOT OVERFILL!)

IMPORTANT: Always fill your spa through the filter bucket after draining. Failure to do so may cause air to be trapped in either pump, preventing the pump from circulating water. Remove the hose and replace the filter cartridge. Note: DO NOT overtighten filter cartridge, finger tight only!

3. Turn On Power

Turn on power to spa at the home's circuit breaker to start boot up sequence (sec. 10.0, page 25). The heater and filter pump will automatically activate after several seconds. If the control panel LED flashes water temperature and “COL” or “ICE” this is normal, refer to page 38 for additional information.

4. Activate Jets Pumps

Turn on jets pump(s) to ensure proper mixing when adding start-up chemicals in step 5.

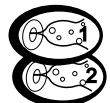

5. Add Start-Up Chemicals

Add the spa water chemicals as recommended by your authorized Jacuzzi dealer. See Section 13.0 "Water Quality Maintenance" (page 36) for general guidance.



WARNING: RISK OF POISONING OR DEATH.

Never leave chemicals opened and accessible to anyone. Use chemicals according to the vendors instructions. Always store chemicals in a safe and/or locked location. Keep away from and out of reach of children.

6. Establish A Stable Sanitizer Reading

Establish a stable sanitizer reading between 3.0-4.0 ppm chlorine or 2.0-4.0 ppm bromine. To ensure healthy water conditions, always maintain a constant sanitizer reading within the levels recommended by the Association of Pool and Spa Professionals/USA printed on the inside cover of this manual. If sanitizer levels cannot be stabilized, perform the decontamination procedure steps 9-16 on pages 20-22.

Note: The "decontamination procedure" steps 9-16 should also be used after the spa has been "Winterized" (Section 12.7 page 35) or has been sitting without power for an extended period.

7. Set Spa To Heat

To warm spa water to a comfortable temperature, follow these steps:

- The LED display on the control panel displays the actual temperature of the spa water. Press either the COOLER (⊖) or WARMER (⊕) button once to display the "set" temperature for 5 seconds. If you want the water to heat to a different temperature, simply press COOLER (⊖) or WARMER (⊕) within 5 seconds. The set temperature increases or decreases by one degree each time one of these buttons is pressed.
- The heater will turn off when the temperature corresponding to the thermostat setting is achieved.



Important Heater Details:

- The maximum water temperature setting for your spa is 104 °F (40 °C) and the minimum setting is 65 °F (18 °C).
- For North American spas connected to a 40 amp service, jets pump #1 must be set to low speed and jets pump #2 must be turned off to operate the heater.
- For Export spas connected to a 20 amp service, jets pump #1 must be set to low speed and jets pump #2 must be turned off to operate the heater.
- Setting the thermostat at maximum will not accelerate the heating process. This will only result in a higher ultimate temperature.
- The heater operates until the water reaches the programmed "set temperature", then turns off. The heater will reactivate after the water cools to approximately 1.5° below the set temperature.

8. Place Cover On Spa

- Keeping the insulating cover in place anytime the spa is not in use will reduce the time required for heating, thereby minimizing operating costs.
- The time required for initial heat-up will vary depending on the starting water temperature.



DANGER: RISK OF PERSONAL INJURY.

Check water temperature carefully before entering hot tub! Excessive water temperature can cause burns, welts and body temperature to rise, hyperthermia (over-heating).

Decontamination Procedure (Steps 9-16)

Steps 9-16 below are only required when sanitizer levels are unstable after performing steps 1-6 above. Disregard steps 9-16 below if sanitizer levels remain stable at 3.0-4.0 ppm chlorine or 2.0-4.0 ppm bromine after performing steps 1-6.

9. Add 2.5 ounces of sodium dichlor for every 100 gallons of water. Refer to the table below for approximate water fill volume by model.



CAUTION: RISK OF PERSONAL INJURY OR SPA DAMAGE!

Never add chlorine tablets (trichlor) or acid to your hot tub for any reason! These chemical may damage components within your hot tub, burn or irritate your skin, create a rash, and void the manufacturer warranty for your spa.

Water Fill Volume by Model

Spa Model	Approximate Fill Volume	Sodium Dichlor
J-375	530 US Gallons (2,006 Liters)	13.5 oz
J-365	500 US Gallons (1,893 Liters)	12.5 oz
J-355	485 US Gallons (1,836 Liters)	12.0 oz
J-345	458 US Gallons (1,734 Liters)	11.5 oz
J-335	453 US Gallons (1,715 Liters)	11.5 oz
J-325	430 US Gallons (1,628 Liters)	11.0 oz
J-315	274 US Gallons (1,037 Liters)	7.0 oz

10. Leave spa cover open during this step to allow excessive chemical vapors to exit spa, protecting pillows and plastic knobs from chemical attack. If spa is indoors, open doors and windows for proper ventilation. Turn on all jet pumps for one hour, then place the massage selector knob in the center “combo” position and open all air controls.



Note: You will need to press the jets pump button(s) every 20 minutes since these functions have an automatic 20 minute time-out function that turns them off.



WARNING: RISK OF PERSONAL INJURY!

- To decrease the risk of injury, drowning or entrapment, never leave your hot tub unattended for any reason while the cover is open and accessible, especially to small children and animals!
- Precautions should be taken to minimize your exposure to chemical vapors (that could cause lung, brain, or skin damage).

11. Turn off power to the spa at the circuit breaker, then drain spa as outlined in Section 12.2 “Draining And Refilling” (page 33).
12. Fill spa until water covers all jets but does not touch the bottom of the lowest headrest. **DO NOT OVERFILL.**

CAUTION: TO DECREASE BUILD UP ON COMPONENTS AND MINIMIZE ACRYLIC DAMAGE.

Never fill with water from a water softener. If your water is extremely “hard”, it is preferable to fill half-way with hard water and the rest of the way with softened water. You may fill entirely with hard water if you use a special water additive available from your Jacuzzi dealer.

13. Consult your authorized Jacuzzi dealer for chemical recommendations, then add chemicals to spa water to achieve a constant sanitizer reading within the levels recommended by the Association of Pool and Spa Professionals/USA printed on the inside cover of this manual.
14. Turn on all jet pumps when adding chemicals to ensure proper mixing and leave your spa cover open until the sanitizer level falls below 4.0 ppm to protect pillows and plastic knobs from chemical attack.



WARNING: RISK OF PERSONAL INJURY.

- To decrease the risk of injury, entrapment or drowning, never leave your hot tub unattended for any reason, especially if while the cover is open and accessible to small children and animals!
- To decrease the risk of contracting a waterborne illness (e.g. an infection, bacteria or virus) and/or respiratory ailments, maintain water chemistry within 6 step parameters. If you or other bathers experience such a condition, discontinue use and seek immediate medical attention.

15. Establish a sanitizer reading between 3.0-4.0 ppm chlorine or 2.0-4.0 ppm bromine, then allow the spa to set undisturbed for 8 hours. Retest water after 8 hours to determine if sanitizer levels are stable. If sanitizer levels are stable, your spa is ready for use. To ensure healthy water conditions, always maintain a constant sanitizer reading within the levels recommended by the Association of Pool and Spa Professionals/USA printed on the inside cover of this manual. If sanitizer levels are not stable at this time, it will be necessary to repeat this procedure in its entirety (steps 1-15) until stable sanitizer readings are achieved.
16. After adequate sanitizer levels are achieved, close all spa air controls by rotating them clockwise to maximize heat retention when spa is not in use.

9.0 Control Functions

9.1 Control Panel

- A. **LED Display:** Can display current water temperature (default display), water temperature set point, selected filtration/heating mode, and error messages.

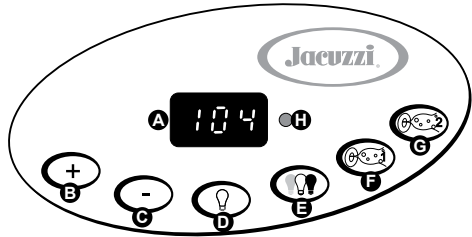

2-Pump Control Panel Shown

- B. **Warmer (+) Button:** Increases water temperature set point.
- C. **Cooler (-) Button:** Decreases water temperature set point.
- D. **Light On/Off (Ⓛ) Button Options:** Turns waterfall, footwell light, lighted cup holders and backlit pillows on in unison. Press once for high intensity; press a second time for medium intensity; press a third time for low intensity; press a fourth time to turn off. The displayed color is changed using the light mode button (E) below.
- E. **Light Mode (Ⓛ) Button:** Selects one of 4 color modes for waterfall, footwell, cup holders, and pillow lights. See page 26 for addition information.
- F. **Jets 1 Button:** Turns jets pump #1 on and off. Press once for low speed; press a second time for high speed; press a third time to turn pump off.
- G. **Jets 2 Button (J-335 to J-375):** Turns high-speed jets pump #2 on and off. Press once to turn pump #2 on; press a second time to turn pump #2 off.
- H. **Heat Indicator:** Lit when heater is on.

Operation Details

- Temperature Adjustment: 65 to 104 °F (18 to 40 °C). Factory default setting is 100 °F (38 °C).
- Light Operation: All LED lights run for 2 hours, then automatically shut off.
- Jets 1/Jets 2 Button Operation: Jets run for 20 minutes when activated, then turn off automatically to conserve energy. Simply press either jets button to continue operation for an additional 20 minutes.

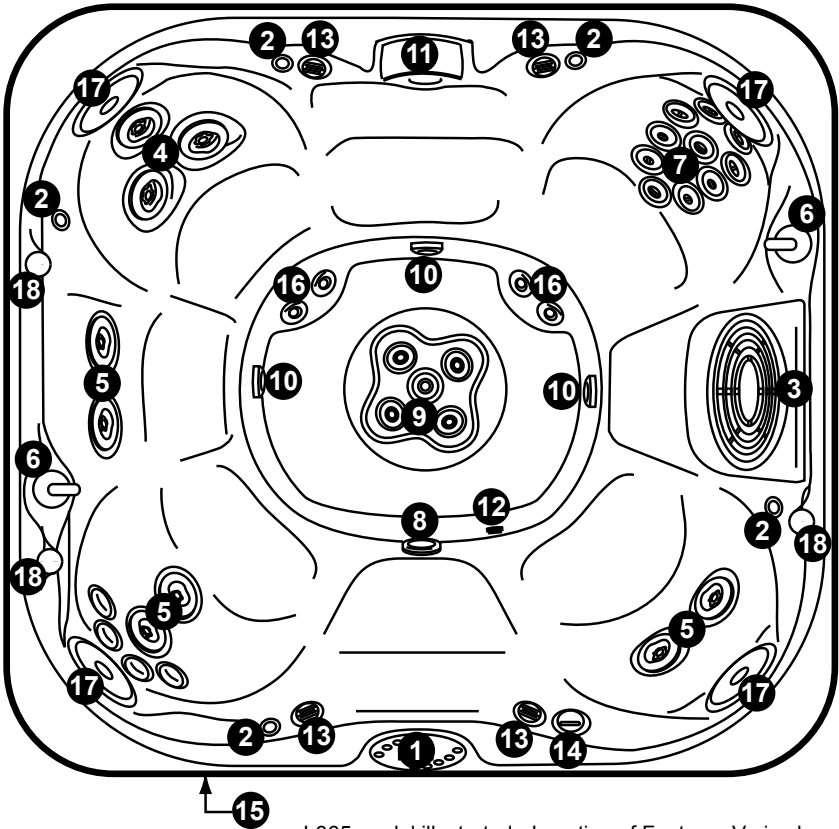
9.2 General Spa Features And Controls

J-365 model illustrated - Location of Features Varies by Model. Specifications/features subject to change without notice.

- | | |
|---|--|
| 1. Control Panel | 11. Waterfall Feature |
| 2. Toggle Air Controls | 12. Heater Return Fitting |
| 3. Filter/Skimmer Grill | 13. Optional Audio System Speakers |
| 4. PowerPro MX Jets | 14. Optional Audio System Remote Control |
| 5. Therapy Jets | 15. Optional Audio System Receiver |
| 6. Massage Selector Valves | 16. Calf Jets |
| 7. Therapy Seat | 17. Backlit Pillows |
| 8. Spa Light | 18. Lighted Cup Holders* |
| 9. Vertical Jets (Foot Jets) | |
| 10. Footwell Suction Fittings and Filters | |
- *Light features not offered on J-315/J-325 Models.

Specifications Subject to Change Without Notice.

10.0 Operating Instructions

The spa control system has automatic functions that operate upon start-up and normal operation to protect the system. Upon power up, the readout displays the following information:

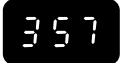
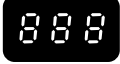
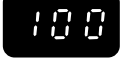
1. Control panel displays current software release (e.g. 3.57), then; 1. 
2. Control panel displays "888" and all indicator LEDs are lit, permitting visual inspection of all display segments and indicator lights for proper operation. 2. 
3. After the initial start-up sequence ends, the actual water temperature is displayed. If water temperature at this time is less than the factory default temperature setting of 100 °F (38 °C) and the spa is set to either standard filtration/heating mode (page 28), the heater will turn on and run until the water temperature rises to the factory setting, then turn off. 3. 

Note: It is common for the heater to turn on after the spa is first filled because tap water is often very cold.

10.1 Setting Water Temperature

The spa's thermostat provides optimum control of water temperature. The temperature set point (set temperature) can be adjusted from 65-104 °F (18-40 °C). To raise the set temperature, press the WARMER (⊕) button. To lower the set temperature, press the COOLER (⊖) button. The first press of either WARMER (⊕) or COOLER (⊖) button displays the set temperature. To access the overtemp feature that allows the spa to reach 106 °F (41 °C) follow the steps below (Figure 1).

- A. Press and hold the WARMER (⊕) button then;
- B. Press and hold the JETS 1 (⊗) button at the same time for 2 seconds. You will see the temperature rise to 106 °F (41 °C) on the LED display. To lower the temperature, press the COOLER (⊖) button.

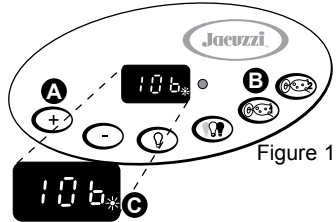

Figure 1

- C. When the overtemp has been activated, the white decimal point after the last digit will flash on and off every second as an indicator for being in the overtemp mode.

Note: Once the temperature goes below 104 °F (40 °C) and you would like to raise the temperature to 106 °F (41 °C) again, you will have to repeat the steps above.

10.2 Activate Jet Pumps

The control panel JETS 1 button activates jets pump 1. The first press activates low speed, the second press activates high speed, and the third press shuts jets pump 1 off. The JETS 2 button activates jets pump 2. The first press activates high speed, the second press turns jets pump 2 off. When manually activated, either pump will automatically turn off after 20 minutes.

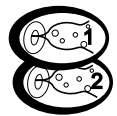

10.3 Light On/Off Button

Pressing this button activates the waterfall, footwell light, lighted cup holders, backlit pillows and optional exterior lights in unison as follows: high - medium - low - off.

Note: Lights automatically turn off after 2 hours.



10.4 Light Mode Button

This button offers 4 light modes for your enjoyment. Press this button to select your favorite lighting effect as follows:

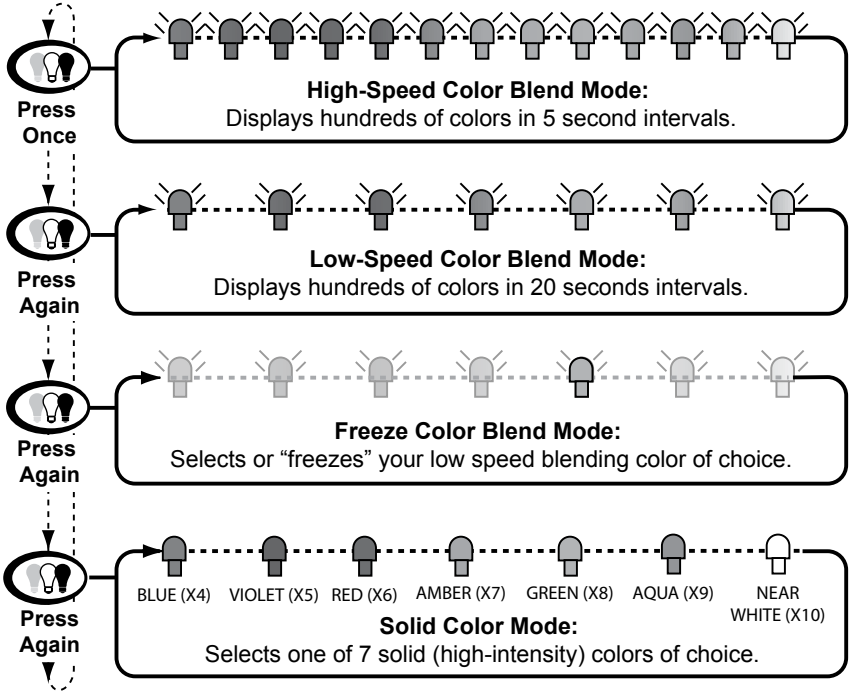

10.5 Jets

The water flow through individual jets in your spa can be adjusted or turned off by rotating the outside jet ring. Some jets offer an adjustable center nozzle that allows you to change the water discharge angle. Simply tilt the center nozzle in these jets to the desired angle to customize your personal massage. Other jets offer a spiral action that produces a surging stream of air and water that provides a vigorous massage.

Note: Always keep at least 6 adjustable jets open at all times to ensure proper filtration characteristics within the spa. Jets may not spin with jets pump 1 running in low speed.



10.6 Selecting Desired Massage Action

All models incorporate a massage selector valve that allows you to customize the massage and performance by diverting water between various jet systems within the spa. Simply turn valve to positions A, B or C to divert water pressure to various jet groups.

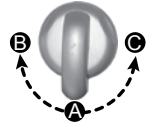

Note: The valve is intended to operate in positions A (Combo), B, or C for optimum performance. It is considered normal for sound levels within the valve to increase between these positions due to the large amounts of water flowing through it. For optimum filtration benefits, always leave this valve in position A when the spa is covered and select positions B or C for maximum jet performance during spa use.

10.7 Waterfall Feature

The waterfall feature allows you to independently control it for a customized soothing effect. The JETS 1 button activates the waterfall feature.

Note: The operation of the waterfall light feature is covered in Sections 10.3-10.4 (page 26).

Waterfall Operation Details:

- J-315/J-325 Models: Move control lever next to the waterfall body inward to start or increase flow or move outward to slow or turn off flow.
- J-335, J-345, J-355, J-365 and J-375:
 - A. Push thumb wheel on top of waterfall to the left (while in spa) to start or increase flow.
 - B. Push thumb wheel on top of waterfall to the right (while in spa) to slow or turn flow off.

10.8 Air Controls

Certain jet systems have their own “toggle” on/off air control. Each control introduces air into the water lines that supply specific jet groups. Simply press any air control button Jacuzzi logo side down to open or press the opposite side of button to close.



Note: To minimize heat loss, close all air controls (Jacuzzi logo up) when spa is not in use. Certain jets may not draw air when jets pump 1 is running in low speed; this is considered normal.

10.9 Optional Audio System (J-335 to J-375)

Spas equipped with the optional Jacuzzi audio system offer enhanced enjoyment. These models include an integrated AM/FM/CD receiver with four high-quality marine speakers for unsurpassed sound quality and long-life. Refer to Section 17.0, (page 46).

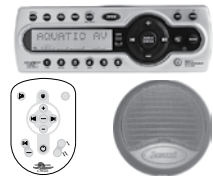

11.0 Automatic Filtration Cycles

Your new spa includes a 24-hour circulation pump which filters the water continuously. The circulation pump draws water through the skimmer bag and one of two filter cartridges to effectively remove small debris in your spa.

Note: The 24-hour circulation pump system also supplies heated water to the spa when the heater turns on. The pump is not programmable.

The control system activates a programmable “standard” or “economy” filtration/heating cycle to remove larger debris missed by the 24-hour circulation pump filtration system. These cycles utilize pump #1 low speed and the second filter cartridge to quickly “skim” the water of large debris and minimize their “bath-tub ring” effect. Apart from their skimming benefit, each mode also effects the operation of your spa’s heater. Refer to Sections 11.1 and 11.2 below for additional information.

11.1 Standard Filtration/Heating Modes (F0-F3)

Standard filtration/heating modes are typically selected by customers in cold climates where heat up times are extended due to lower ambient temperatures. In these modes, the water temperature is regulated by the set temperature, 24-hour circulation pump, and heater which turns on as needed. After the programmed set temperature is reached, the heater turns off and the circulation pump continues to operate 24-hours to filter and clean your spa unless in summer logic; see Section 14.1, page 38.

11.2 Economy Filtration/Heating Modes (F4-F6)

Economy filtration/heating modes are typically selected by customers in warm climates where heat up times are minimized due to higher ambient temperatures. In these modes, the water temperature is regulated by the set temperature, 24-hour circulation pump, and heater only while a programmed filter cycle is running (unless in summer logic; see Section 14.1, page 38).

11.3 Lock Modes (L1-L2)

These modes are designed for use during spa service or to prevent unauthorized use.

11.4 Selecting The Filtration/Heating Mode

Press and hold both control panel WARMER (⊕) and COOLER (⊖) buttons at the same time, then release. Then press either WARMER (⊕) or COOLER (⊖) button to select filtration/heating mode F0-F6 or lock modes L1-L2 below:

Standard Filtration/Heating Modes

- F0** 5 minutes of filtration per day (one 5 minute “Blow-Out” cycle every 24 hours to purge all plumbing lines)
- F1** 1 hour of filtration per day (one 30-minute cycle every 12 hours); **This is the factory default setting.**
- F2** 1.5 hours of filtration per day (one 30-minute cycle every 8 hours)
- F3** 2 hours of filtration per day (one 30-minute cycle every 6 hours)

F0

F1

F2

F3

Economy Filtration/Heating Modes

- F4** 1 hour of filtration/heating per day (one 30-minute cycle every twelve hours)
- F5** 1.5 hours of filtration/heating per day (one 30-minute cycle every eight hours)
- F6** 2 hours of filtration/heating per day (one 30-minute cycle every six hours)

F4

F5

F6

Lock Modes

- L1** Lock Out: disables all spa functions to permit filter cleaning.
- L2** Lock Mode: disables the jets and light buttons to prevent unauthorized use of spa. Filtration/heating cycle will continue to operate as programmed in this mode. The temperature display flashes when this function is enabled. Example: The “F3” filtration/heating cycle was enabled prior to choosing lock mode. The spa continues to perform the “F3” cycle until lock mode is canceled, allowing another cycle to be selected.

L1

L2

To set a time for the first filtration/heating cycle, simply turn power on to the spa two minutes prior to the desired time. Example: If you desire your first filtration/heating cycle to begin at 10:00 AM turn off power to the spa and turn it back on again at 9:58 AM.

Note: Start time is approximate and may vary slightly from day to day.

12.0 Spa Maintenance

Proper and regular maintenance of your spa will help it retain its beauty and performance. Your authorized Jacuzzi dealer can supply you with all the information, supplies, and accessory products you will need to accomplish this.



DANGER: RISK OF SEVERE INJURY OR DROWNING BY ENTRAPMENT!

- Keep hair, loose articles of clothing or hanging jewelry away from suction fittings, rotating jets or other moving components to avoid entrapment that could lead to drowning or severe injury.
- Never use the spa unless all suction guards, filter, filter lid, or skimmer assembly are installed to prevent body and/or hair entrapment.
- Never operate or use the spa if the filter, filter lid, or skimmer assembly are broken or any part of the skimmer assembly is missing. Please contact your dealer or nearest service center for service.
- The suction fittings and suction covers in this spa are sized to match the specific water flow created by the pump(s). If it is necessary to replace the suction fittings, suction covers or pump(s), be sure that the flow rates are compatible and are in compliance with the VGB Safety Act page 2.
- Never replace a suction fitting or suction cover with one rated less than the flow rate marked on the original suction fitting. Using improper suction fittings or suction covers can create a body or hair suction entrapment hazard that may lead to drowning or severe injury.
- Owners must alert all spa users to the potential risk of Hair, Limb, Body, Evisceration (disembowelment), and Mechanical Entrapment, page 6.

12.1 Cleaning The Filters

Your Jacuzzi spa is equipped with a skimmer bag and two high performance pleated filter cartridges located under the filter cover. Fine debris are filtered by the circulation pump drawing water through the skimmer bag and filter cartridge 24-hours a day. Large debris are filtered by jets pump #1 drawing water through the skimmer bag and second filter cartridge during an automated skimming/heating cycle or when jets pump 1 is manually activated during spa use. Combined, both filters provide unsurpassed water quality by trapping surface oils and suspended particles.

An optional chemical feeder is available through your authorized Jacuzzi dealer that installs under the filter cap (#2472-673). Always remove the chemical feeder cap and feeder (when used) during the filter cleaning process by turning the cap handle counterclockwise. Reinstall the cap and feeder back onto the filter cartridge after the filter cleaning process is complete. It is recommended that latex gloves be used to avoid touching the chemical feeder during the filter cleaning process.

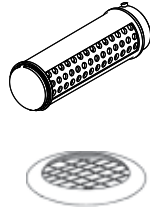

Note: When used, the chemical feeder **MUST** remain on the circulation pump filter cartridge! This filter cartridge is the one with the grid across the wall fitting as shown (right).

TO DECREASE RISK OF DEATH, DROWNING OR ENTRAPMENT, ALWAYS TURN POWER TO SPA OFF BEFORE CLEANING THE FILTER CARTRIDGES!

Note: Refer to steps A-J on following page for complete filter cleaning/replacement instructions.

A **DANGER: TURN POWER TO SPA OFF! TO DECREASE RISK OF DEATH, DROWNING, OR ENTRAPMENT, NEVER OPERATE SPA WHEN FILTER IS NOT PROPERLY INSTALLED OR IF SKIMMER ASSEMBLY IS DAMAGED OR ALTERED!** ⚠

B

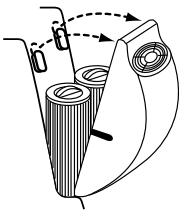

Lift cover approx. 3/8" to unclip, then tilt forward to access filter cartridges.

C

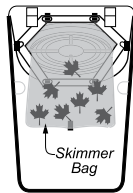

(Filter Cover Back View)

Remove skimmer bag from clips, then clean out debris.

D

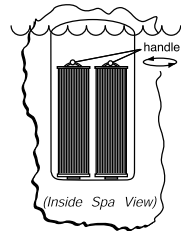

Rotate each filter cartridge handle counterclockwise to unthread from mating wall fitting.

E

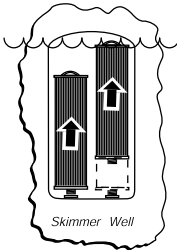

Lift unthreaded filter cartridge from skimmer well.

F

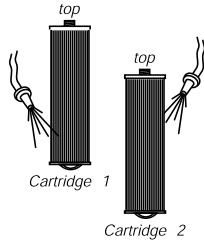

If used, remove the chemical feeder as instructed prior to rinsing the filter cartridges. Rinse debris from filter pleats on each cartridge using a garden hose and high pressure nozzle. Start at the top and work downward towards handle. Repeat until all pleats are clean.

G

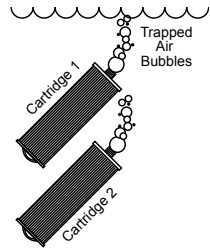

Submerge both filter cartridges in spa. Tilt threaded end upward to remove trapped air bubbles, then keep cartridges submerged to prevent air entrapment during installation (step H).

H

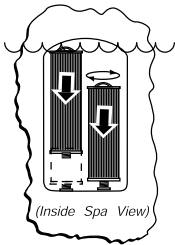

Place each cartridge back into skimmer well, then rotated each cartridge handle clockwise to thread back into wall fitting. **DO NOT OVERTIGHTEN!**

I

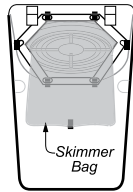

(Filter Cover Back View)

Install clean skimmer bag back onto the filter cover clips as shown.

J

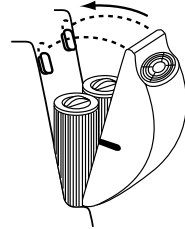

1. Tilt filter cover back against clips, then lift approx. 3/8" to latch against spa shell.
2. Turn power to spa back on.

Periodically, the filter cartridge will need a more thorough cleaning to remove imbedded oils and minerals. For this, we suggest cleaning as illustrated in step “F”, followed by soaking the filter overnight in a plastic container filled with a solution of water and specially formulated filter cleanser available from your authorized Jacuzzi dealer. The average life expectancy of each filter is approximately two years with proper care and water quality maintenance. Replacement cartridges may be purchased from your authorized Jacuzzi dealer.

12.2 Draining and Refilling

About every 3 months, you will want to replace the spa’s water. The frequency depends on a number of variables including the amount of use, attention paid to water quality maintenance, etc. You will know it is time for a change when you cannot control sudsing and/or you can no longer get the normal feel or sparkle to the water even though the key water balance measurements are all within the proper parameters.

CAUTION! READ THIS BEFORE DRAINING: To prevent damage to the spa’s components, **turn off power to the spa at the circuit breaker before draining it.** Do not turn the power back on until your spa has been refilled.

CAUTION: There are certain precautions to keep in mind when draining your spa. If it is extremely cold, and the spa is outdoors, freezing could occur in the lines or the equipment, see “WINTERIZING” (page 35). On the other hand, if it is hot outdoors, do not leave the spa’s surface exposed to direct sunlight.

To drain your spa, perform the following steps:

1. Turn off power to spa at breaker.
2. Locate the drain valve on the front/lower plastic pan. Hold the larger (rear) body to prevent it from turning, then loosen and remove the front cap to expose the underlying male hose threads.
3. Attach a garden hose to the exposed threads.
4. Gently rotate the larger (rear) valve body 1/3 turn counterclockwise to unlock the drain valve.
5. Pull the larger (rear) body outward to open drain.
6. After the spa drains, perform steps 2-5 in reverse order to close the drain prior to refilling the spa.

1. Turn off power to spa.

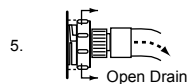
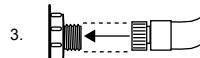
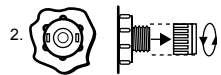

After refilling, turn on power to the spa and follow the steps listed under “Spa Fill Up Procedure” (page 18). Always fill your spa through both filter wall fittings.

12.3 Pillow Care

Remove and clean the headrest pillows as needed with soapy water using a cloth or soft-bristle brush. Always remove the pillows when adding chemical shock treatment to the spa water. When the sanitizer reading is below 4.0 ppm, pillows can be reinstalled.



CAUTION: Never attempt to remove the pillows by pulling on the complete assembly! The pillows utilize a bolt-on design that prohibits removal without tools.

To remove pillows:

1. Grasp pillow insert (A) with finger tips and gently pry outward from pillow base (C).
2. Use a standard screwdriver to loosen and remove mounting bolts (B) from pillow base.
3. Assemble in reverse order after cleaning.
DO NOT overtighten pillow mounting bolts!

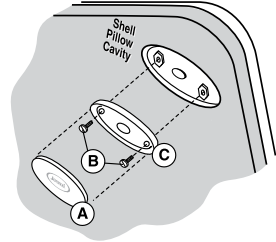

12.4 Cleaning The Spa Interior

To preserve the sheen of your spa's surface, it is crucial that you avoid using abrasive cleaners or cleaners which have adverse chemical effect on the surface. If you are not certain as to the suitability of a particular cleanser, consult your authorized Jacuzzi dealer. Regardless of the cleanser used, use extreme care to assure that no soap residue is left on the surface. This could cause severe sudsing when the spa is refilled.

12.5 Maintaining the Cover

Using the Jacuzzi insulating spa cover anytime the spa is not in use will significantly reduce your operating costs, heat-up time and maintenance requirements. To prolong the life of the cover, handle it with care and clean it regularly using mild soap and water. Periodic treatments with a special conditioner developed for Jacuzzi spa covers will help protect against deterioration caused by UV rays from the sun. Never allow anyone to stand or sit on the cover, and avoid dragging it across rough surfaces.

12.6 Maintaining The Synthetic Cabinet

Your new spa's synthetic cabinet requires little or no maintenance of any kind. To clean, simply wipe cabinet with a clean towel and mild soap solution.



CAUTION: Never spray cabinet with a garden hose for any reason since this action may induce an electrical short in the spa's electrical equipment.

12.7 Winterizing

Your Jacuzzi® spa is designed to automatically protect itself against freezing when operating properly. During periods of severe freezing temperatures, you should check periodically to be certain that the electrical supply to the spa has not been interrupted. In extreme, bitter cold weather less than -20 °F (-29 °C), choose the F3 "Standard" filtration/heating mode to prevent freezing (page 28).

If you do not intend to use your spa, or if there is a prolonged power outage during periods of severe freezing temperatures, **it is important that all water be removed from the spa and equipment to protect against damage from freezing.**

Expert winterization of your spa is highly recommended, contact your authorized Jacuzzi dealer. In emergency situations, damage can be **minimized** by taking the following steps:

CAUTION: TURN OFF POWER TO HOT TUB!

1. Turn off power to the spa.
2. Follow the directions on page 33 for draining the spa.
3. Turn the massage/diverter selector(s) into the middle combo position to allow the water in the plumbing lines to drain, see page 27.
4. Turn the waterfall valve(s) to the open position to allow the water in the plumbing lines to drain, see page 27.
5. As the water level drops below the seats, use whatever means necessary to get the water out of the recessed seating areas and into the foot well, such as a wet/dry vacuum.
6. When the water level ceases to drop, use whatever means available to remove any remaining water from the foot well, such as a wet/dry vacuum.
7. Remove the synthetic cabinet panel under the control panel and locate the drain plugs on the front of the pump(s), (Figure A, page 16). Remove plugs to allow water to drain out of pumps and heater.

Note: Approximately one to two gallons will be released during this procedure. Use a wet/dry vacuum or other means to keep this from flooding the equipment compartment. Replace the drain plugs.

8. Reinstall synthetic cabinet side panel and cover spa so that no casual moisture can enter into it.

Consult your authorized Jacuzzi dealer if you have any questions regarding winter use or winterizing.

12.8 Restarting Your Spa in Cold Weather

If you want to start up your spa after it has sat empty for a time in freezing temperatures, be aware that the water remaining in certain sections of the piping may still be frozen. This situation will block water flow preventing the spa from operating properly and possibly damaging the equipment. We recommend you consult your authorized Jacuzzi dealer for guidance before attempting to restart your spa under these conditions.

13.0 Water Quality Maintenance

To decrease the risk of contracting a waterborne illness (e.g. an infection, bacteria or virus) and/or respiratory ailments, maintain water quality within specified limits. This will enhance your enjoyment and prolong the life of the hot tub's equipment. Doing so requires regular attention because the water chemistry involved is a balance of several factors. Procrastination in regard to water maintenance will result in poor and potentially unhealthful conditions for soaking and even damage to your hot tub investment. For specific guidance on maintaining water quality, consult your Authorized Jacuzzi dealer who can recommend appropriate chemical products for sanitizing and maintaining your hot tub.



WARNING: FAILURE TO MAINTAIN WATER QUALITY WILL:

- Increase risk of contracting a waterborne illness (e.g. an infection bacteria or virus) and/or respiratory ailments.
- Damage the equipment, components and spa shell, which are not covered under the hot tub's warranty.

CAUTION: Never store hot tub chemicals inside the hot tub's equipment bay. The equipment bay may reach elevated temperatures, this is where high voltage electronic devices are located. This area is not intended for storage of any kind.

13.1 pH Control

pH is a measure of relative acidity or alkalinity of water and is measured on a scale of 0 to 14. The midpoint of 7 is said to be neutral, above which is alkaline and below which is acidic. In spa water, it is very important to maintain a slightly alkaline condition of 7.4 to 7.6 pH. Problems become proportionately severe the further outside of this range the water gets. A low pH will be corrosive to metals in the spa equipment. A high pH will cause minerals to deposit on the interior surface (scaling). In addition,

the ability of the sanitation agents to keep the spa clean is severely affected as the pH moves beyond the ideal range. That is why almost all spa water test kits contain a measure for pH as well as the sanitizer.

13.2 Sanitizing

To destroy bacteria and organic compounds in the spa water, a sanitizer must be used regularly. Chlorine and bromine are the two most popular sanitizers used to date. The "Proclear Mineral Spa Clarifier" designed especially for your hot tub is a beneficial product for water maintenance. Many other additives are available for your spa. Some are necessary to compensate for out-of-balance water; some aid in cosmetic water treatment and others simply alter the feel or smell of the water. Your authorized Jacuzzi dealer can advise you on the use of these additives. When adding spa shock (chlorine or non-chlorine) or pH balancing chemicals activate the jets pump(s) and leave the spa cover open for a minimum of 20 minutes. By doing this you will allow excessive chemical vapors to exit the spa, protecting pillows and plastic knobs from chemical attack.



WARNING: RISK OF PERSONAL INJURY, DROWNING OR ENTRAPMENT!

Never leave your hot tub unattended for any reason while the cover is open and accessible, especially to small children and animals!

CAUTION: RISK OF PERSONAL INJURY OR SPA DAMAGE!

Never add chlorine tablets (trichlor) or acid to your hot tub for any reason! These chemical may damage components within your hot tub, burn or irritate your skin, create a rash and void the manufacturer warranty for your spa.

13.3 CD Ozone Water Maintenance System

If your spa is equipped with the Jacuzzi CD ozone water purification system you will find that your water stays fresh and clear with significantly less chemical sanitizer usage. You will also probably be able to go longer between complete spa drainings.

14.0 Error Conditions/Error Messages

Your spa has a self-diagnostic control system. The system will automatically display the following if a problem is detected.

14.1 Summer Logic

When the actual spa water temperature reaches 2 °F (1 °C) above the set temperature, the spa goes into “summer logic.” The 24-hour circulation pump will turn off automatically to avoid adding additional heat to the water, eventually creating an overheat condition. This setting is not user-programmable.



Note: Summer logic does not take effect until the spa water temperature reaches 95 °F (35 °C). This condition is more likely in excessively hot weather. Remember, the spa’s ability to cool is directly affected by the ambient temperature. An excessively hot ambient temperature may prevent the spa from cooling down because it’s fully insulated construction is designed to retain heat and minimize operating costs.

14.2 Panel Displays COL

Cool Condition - Temperature has dropped 20 °F (11 °C) below the current set temperature. Jets pump 1 and the heater have been activated to bring the temperature within 15 °F (8 °C) of the set temperature. No corrective action is required!



Note: This condition is common during first time fill ups or during refills since tap water is often very cold.

14.3 Panel Displays ICE

Freeze Protection - A potential freeze condition has been detected. No action is required. Jets Pump 1 and heater will activate to circulate and warm water through the plumbing until spa is out of danger. See “Winterizing” (page 35).



14.4 Panel Displays SN1

Open sensor (heater is disabled) or shorted sensor (spa is deactivated). The high-limit temperature sensor is not functioning. Contact your authorized Jacuzzi dealer or qualified service technician.

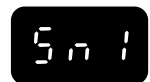

14.5 Panel Displays SN2

Open or shorted sensor (heater disabled). The temperature sensor is not functioning. Contact your authorized Jacuzzi dealer or qualified service technician.



14.6 Panel Flashes FL1 or FL2

A flashing “FL1” display means the flow switch is malfunctioning open, the filter cartridge is excessively dirty or an “air lock” condition has occurred at the circulation pump intake. A flashing “FL2” display means the flow switch is malfunctioning closed. In either case, the spa heater will deactivate and jets pump #1 may also deactivate. To correct condition perform the following:



1. Verify water level is above all jets but below lowest pillow. Add water if necessary.
2. Check for clogged or dirty filter cartridge (sec. 12.1, page 30).
3. Purge “air lock” from circulation pump intake by removing filter cartridge. Hold your garden hose over the filter cartridge wall fitting while using a rag as a seal around hose end. Ask a helper to turn on water for 30 seconds, then turn off. Reinstall filter cartridge and check spa (sec. 12.1, page 30).
4. If the circulation pump is not running, turn power off at the main breaker, then turn power back on. This will reset the circulation pump priming cycle. Once the pump is primed, the error should clear.
5. If problem persists, contact your authorized Jacuzzi dealer.

14.7 Panel Displays OH



**WARNING: RISK OF HYPERTHERMIA (OVER-HEATING)
CAUSING SEVERE INJURY, BURNS, OR WELTS.**

Water temperature is above acceptable limits. **DO NOT ENTER SPA!**

Water temperature has reached 112 °F (44 °C) and the low speed jets pump 1 and optional circulation pump (when equipped) has activated to circulate water through heater.



Contact your authorized Jacuzzi dealer or qualified service technician.

To correct condition:

- Remove the spa's cover and allow your spa to cool down.
- Program the filter settings for Economy Mode (page 28). Raise water temperature setting to cancel Summer Logic condition (page 38).
- If the condition persists, contact your authorized Jacuzzi dealer.

14.8 Panel Displays (- - -)



**WARNING: RISK OF HYPERTHERMIA (OVER-HEATING)
CAUSING SEVERE INJURY, BURNS, OR WELTS.**

Water temperature is above acceptable limits. **DO NOT ENTER SPA!** The safety “Watchdog” software has been triggered and the spa is deactivated. A problem has been detected which could cause damage to the spa or its components.



Contact your authorized Jacuzzi dealer or qualified service technician.

15.0 Troubleshooting Procedures

In the event your Jacuzzi spa is not working the way it should, please first review all the installation and operating instructions in this manual and check for messages on the panel display. If you are still not satisfied it is working properly, please follow the appropriate troubleshooting instructions below.

Note: If any of the supply cords to accessories are damaged, they must be replaced by authorized service personnel. Contact your authorized Jacuzzi dealer or qualified service technician.

15.1 None of the Components Operate (e.g. Pump, Light)

Check the following:

1. Is there power to the spa?
2. Is the household circuit breaker tripped?
3. Contact your authorized Jacuzzi dealer or qualified service technician.

15.2 Pump Does Not Operate But Light Does

Press the JETS 1 button:

If no water movement is detected, make sure power is going to the spa and check the water level. If this does not solve the problem, contact your authorized Jacuzzi dealer or qualified service technician.

The main jets pump 1 operates but no water flows to jets. Check the following:

- Jets may all be closed. Verify all jets are in the open "on" position (sec. 10.5, page 26).
- Pump may not be properly primed. This can happen after the spa is drained and refilled. Press the JETS 1 button on the control panel several times, never leaving the motor running for more than 5 to 10 seconds at a time. Turn power off and let the air out of spa plumbing system by removing the filter cartridge (sec. 12.1, page 30). Make certain you reinstall the filter cartridge before turning on spa power and restarting the jets pump 1.

15.3 Poor Jet Action

- Make sure all jets are in the full open "on" position (page 26).
- Press the JETS 1 button to make certain pump #1 is on.
- Verify all air controls are in the "on" position by pressing down on their Jacuzzi Logo (page 27).
- Check for dirty filter. Clean, if necessary (Section 12.1, page 30).

15.4 Water is Too Hot

Reduce thermostat setting.

15.5 No Heat

1. Check thermostat setting.
2. Keep the spa cover in place while heating.
3. Check the settings to see if your spa is in economy filtration/heating mode (page 28).

Should checking the above steps fail to correct the problem, please call your Jacuzzi Hot Tub dealer so that they may arrange service. We build the best spas in the industry. Nonetheless, we are always striving to improve the quality and features of our products.

Your input as a Jacuzzi spa owner is a cherished part of this process. If you have any comments or suggestions, or if you wish to be informed on any new products for your spa, please write to us.

CONGRATULATIONS on your good taste and welcome to the happiest and most relaxed family in the world!

16.0 Circuit Board Diagrams

16.1 North American J-335, J-345, J-355, J-365 and J-375 Dedicated Power Models (60 Hz)

This wiring diagram is used for all North American, 240V (60 Hz) dedicated power models.

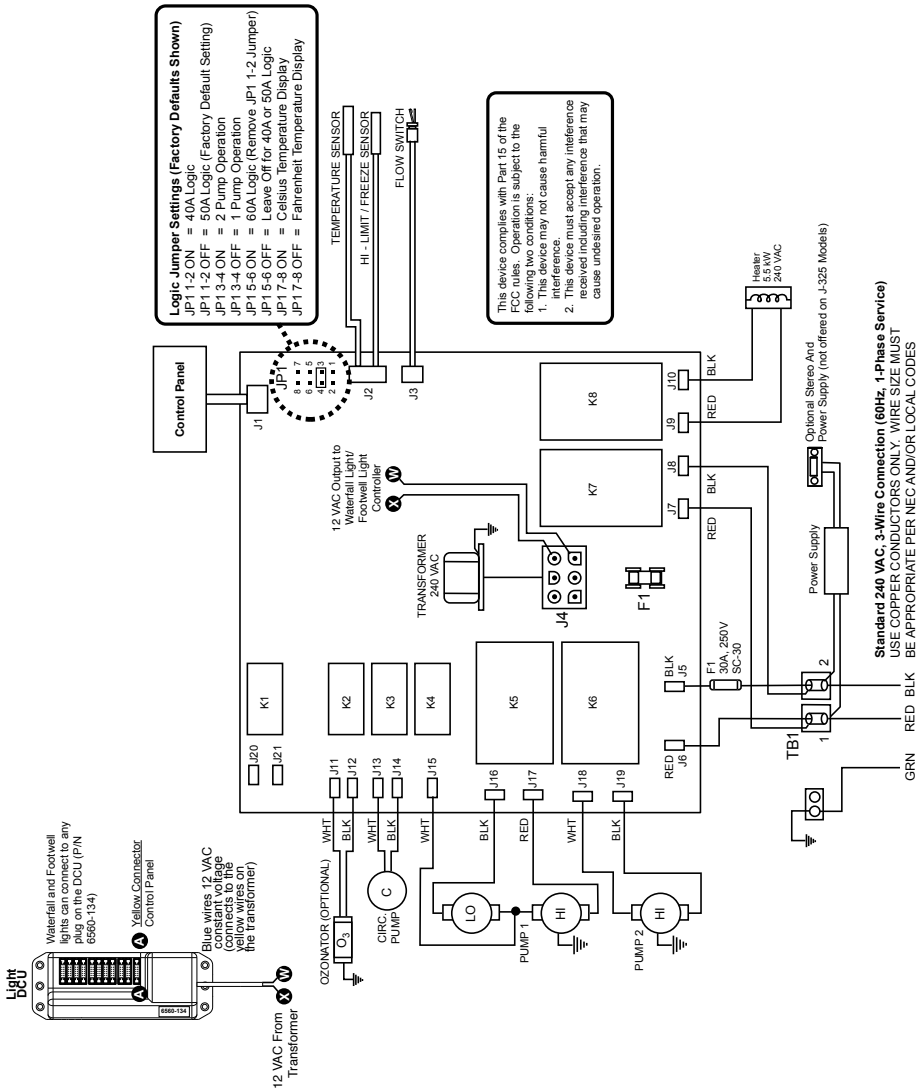

16.2 North American J-315 and J-325 Convertible Power Models (60 Hz)

This wiring diagram is used for all North American 120/240V 60 Hz convertible power models.

Note: Optional 120/240 VAC 4-wire connection enhances heater output from 1kW to 4kW.

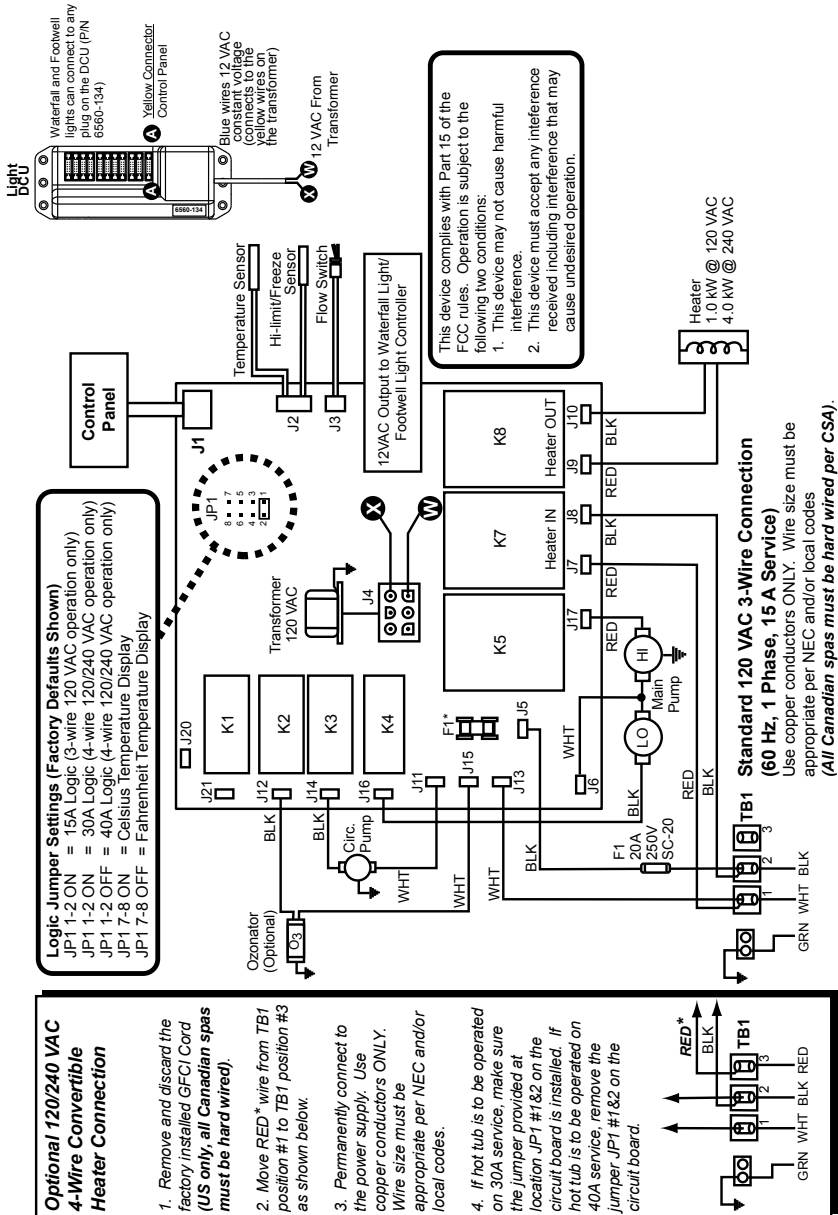

J-300 Series

16.3 Export J-335, J-345, J-355, J-365 and J-375 Models (50 Hz)

This wiring diagram is used for all Export 230 VAC 50 Hz spa models.

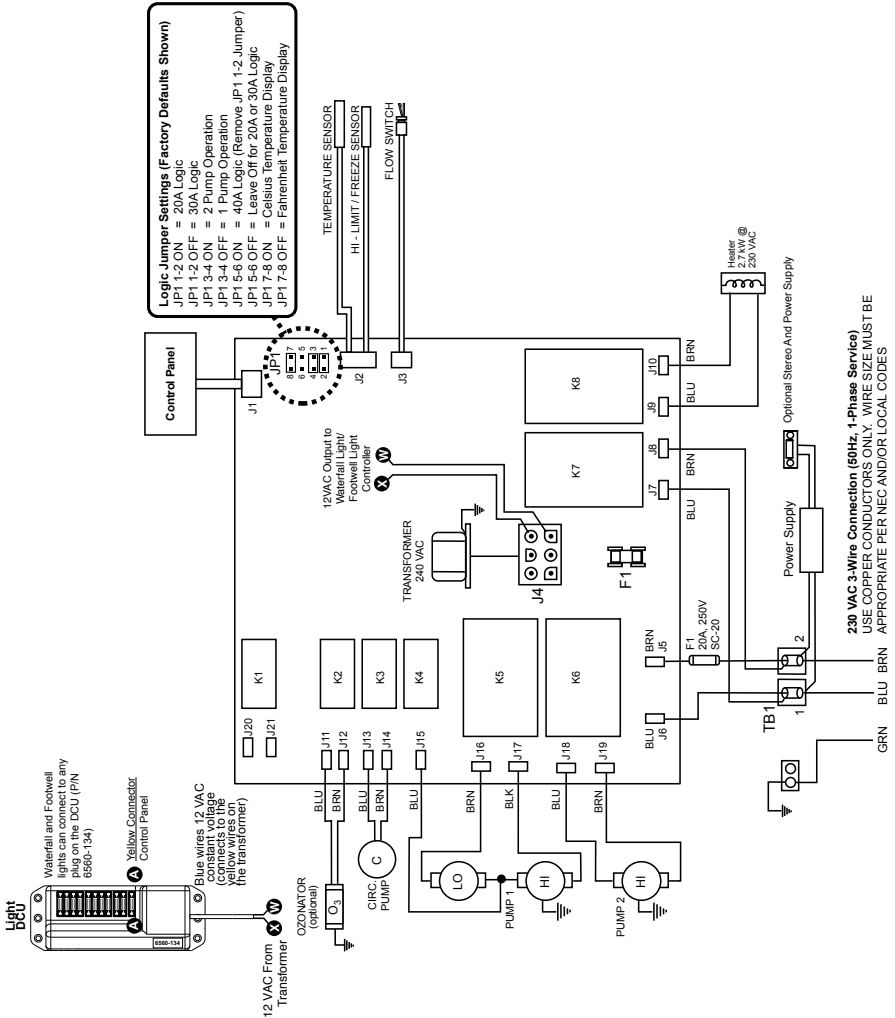

16.4 Export J-315 and J-325 Models (50 Hz)

This wiring diagram is used for all Export 230 VAC 50 Hz spa models.

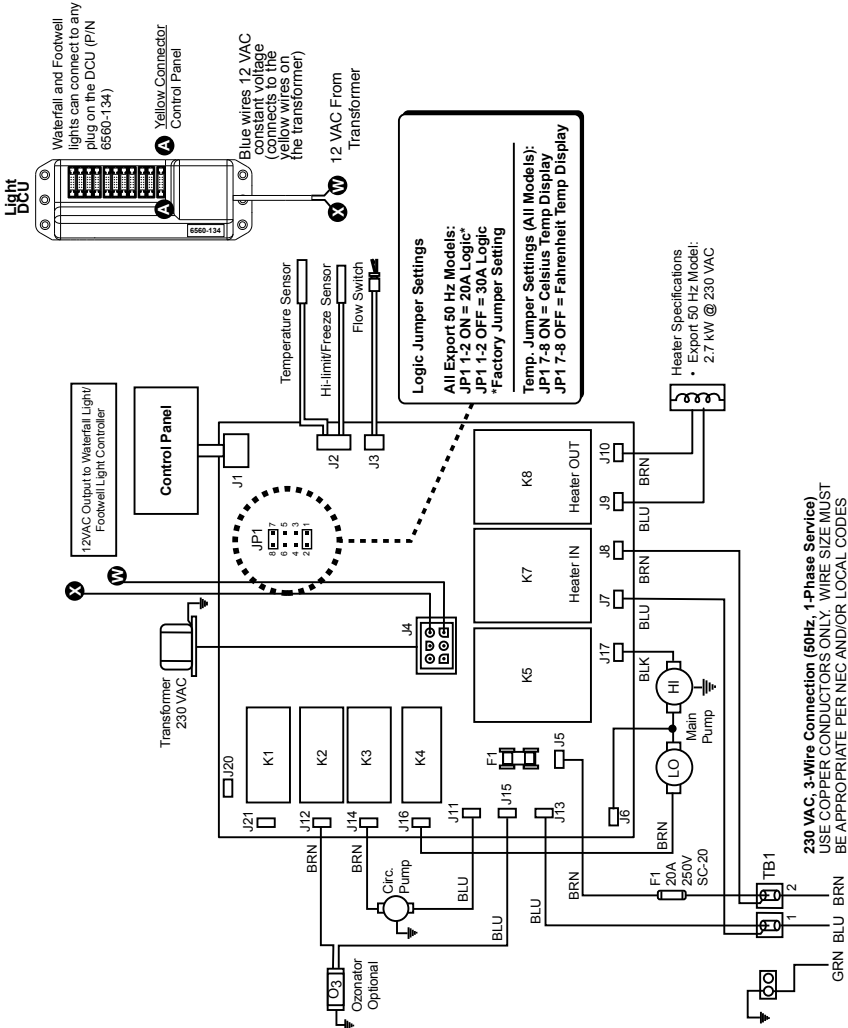

17.0 Optional Stereo Receiver Functions

17.1 Stereo Receiver Control Functions

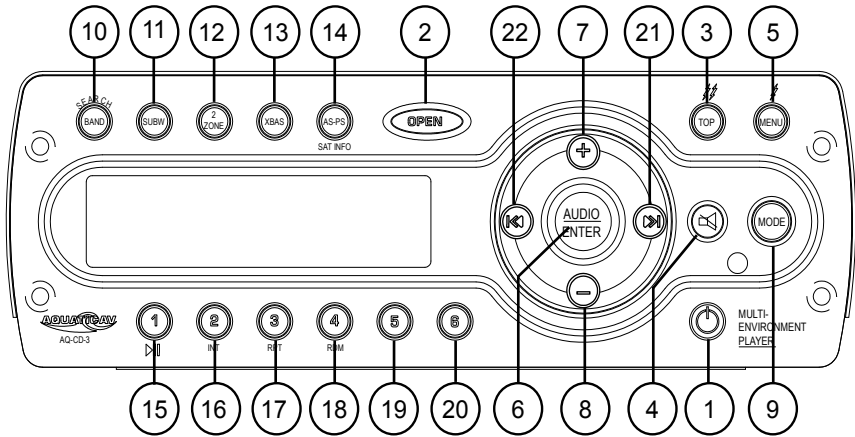



Models equipped with the stereo option only:

To start enjoying your new Stereo Receiver, please read the following operation instructions in their entirety.

1. **Power Button:** Press PWR (Power) to turn deck on or off.
2. **Open Button:** Press Open to flip down the front access panel for CD access. Gently insert CD into slot (DO NOT FORCE!) Make sure to close the front panel to prevent damage to the unit.
 - Eject Button (Not Illustrated): After releasing the front panel, press the Eject button located to the left of CD slot to eject the CD. The unit does not have to be on to eject the CD.
 - Reset button (Not Illustrated): After releasing the front panel, use a pencil or any nonmetallic object to press and hold the reset button for five seconds to reset the main unit and the unit will return to the factory default settings.

Note: Never insert a wet or moist CD since it may damage the mechanism and void the manufacturer warranty.

3. **Top Button:** Has no function.
4. **Mute Button:** Press Mute to mute audio output. The word Mute flashes on the display panel. Press again to return to previous volume level.
5. **Menu Function List Button:** Press Menu to navigate through the list of stereo performance functions. Steps to access menu items:
 - A. To access the MENU press the Menu button < 3 seconds.

- B. "MENU" will be displayed for 2 seconds, and then "CONTRAST" will appear on the display.
 - C. To navigate through the menus use the () or () buttons or press the MENU button repeatedly.
 - D. To adjust the selected menu item, press the VOLUME Up (7) or Down (8) buttons.
 - E. After the selected menu item(s) has been changed and no other buttons have been pressed within the 5 second time-out, the unit will resume to the previous operation.
- **Contrast:** "CONTRAST 5" will be displayed by default. The user now has 5 seconds to press the VOLUME Up or Down buttons to adjust from 0 – 10.
 - **Dimmer:** The dimmer feature of the display is set to "DIMMER High" by default. Use the Volume Up or Down buttons to adjust the Dimmer level between High or Low.
 - **Distant/Local:** "Distant" is the default setting. User now has 5 seconds to adjust with the VOLUME Up or Down buttons from "Distant" (a broader range of signals) to "Local" (only strong local stations). This feature is used to designate the strength of the signals at which the radio will stop during automatic tuning.
 - **Area:** "USA" is the default setting. User now has 5 seconds to select "USA", "LATIN", "EUROPE" or "ORIT" by pressing the VOLUME Up or Down buttons.
- Note:** "LATIN" and "ORIT" are not used.
- **Interamp On/Off:** Feature is not used.
 - **Programmable Turn-on Volume:** "VOL PGM 12" is the default setting. User now has 5 seconds use the VOLUME Up or Down buttons to program the turn on volume.
 - **Beep Tone:** "ON" is the default setting. User now has 5 seconds to adjust by pressing the VOLUME Up or Down buttons from "ON" to "Off".

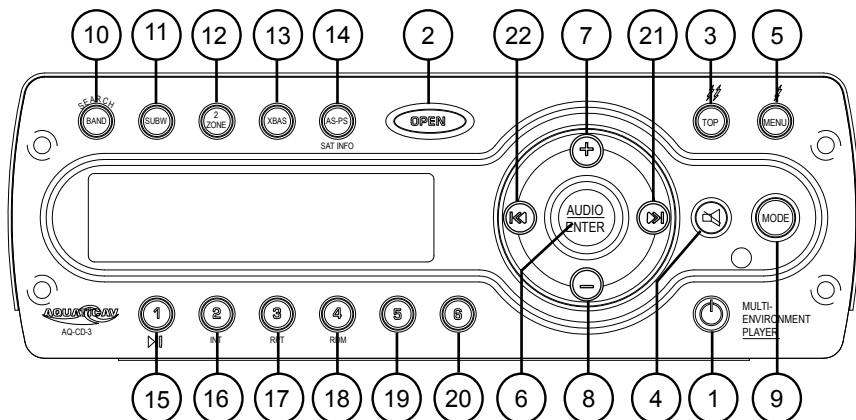

6. **Audio/Enter Button:** Press Audio/Enter to navigate through the stereo sound functions. Short press “AUDIO” button to access the audio menu. User can navigate thru the audio menu items by pressing the “AUDIO” button repeatedly, or by pressing the Tuning Up (22) or Tuning Down Button (21). Once the desired menu item appears on the display, adjust that option by using the Volume Up (7) or Down button (8) within 5 seconds. The unit will automatically exit the Audio Menu after five seconds of inactivity.
- **VOLUME (Volume Level):** User has 5 seconds to use the Volume button to adjust the desire volume level, the volume level will be shown on the LCD display ranging from 00 (lowest) to 46 (highest).
 - **SUBWOOFER (Sub-woofer Level):** User has 5 seconds to use the Volume Up or Down button to adjust the Sub-woofer lever from “00” to “12”.
Note: The Sub-woofer level control is only applicable if the unit is equipped with the optional subwoofer line out, and only if the unit is connected to an optional sub-woofer speaker. The Sub-woofer level control option will only appear in the Audio Menu if the “Sub-woofer” function is activated “ON” by pressing the “Sub-W” button on control panel.
 - **SUB-W LPF (Sub-woofer Low Pass Filter):** User has 5 seconds to use the Volume Up or Down button to select the 4 different Low Pass filters Flat, 80Hz, 120Hz or 160Hz.
Note: The Sub-woofer LPF control is only applicable if the unit is equipped with the optional subwoofer line out, and only if the unit is connected to an optional sub-woofer speaker. The Sub-woofer LPF option will only appear in the Audio Menu if the “Sub-woofer” function is activated by pressing the “Sub-W” button on control panel.
 - **iX-BASS (iX-Bass Level):** User has 5 seconds to use the Volume Up or Down button to select the 3 different Bass Boost level: Low, Mid, or High.

- **BASS (Bass Level):** User has 5 seconds to use the Volume Up or Down button to adjust the desired Bass level range from -6 to +6.
- **BASS -CFQ (Bass Center Frequency):** User has 5 seconds to use the Volume Up or Down button to adjust the desired Bass Center Frequency to 60 Hz, 80 Hz, 100 Hz, or 200 Hz.
- **BASS-Q: (Bass Quality Factor):** User has 5 seconds to use the Volume Up or Down button to adjust the desired Bass Quality Factor to 2N, 1N, 1W or 2W. See Figure 1.

Shows the Bass Quality factor (Curve characteristics) of each step

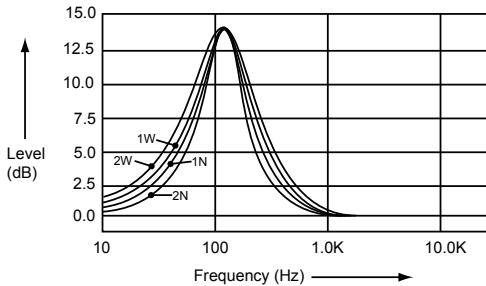

Figure 1

- **MIDDLE (Middle Level):** User has 5 seconds to use the Volume Up or Down button to adjust the desired Middle level range from -6 to +6.
- **MID-CFQ (Middle Center Frequency):** User has 5 seconds to use the Volume Up or Down button to adjust the desired Middle Range Center Frequency to 500 Hz, 1 KHz, 1.5 KHz, or 2.5 KHz.
- **MIDDLE-Q (Middle Quality Factor):** User has 5 seconds to use the Volume Up or Down button to adjust the desired Middle Quality Factor to 2N, 1N, 1W or 2W.

Shows the Middle Quality factor (Curve characteristics) of each step

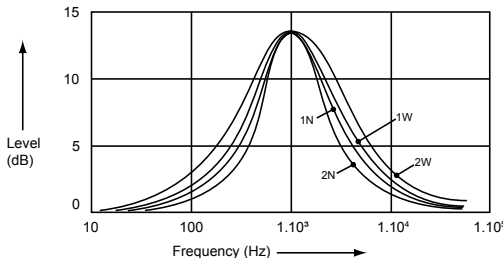
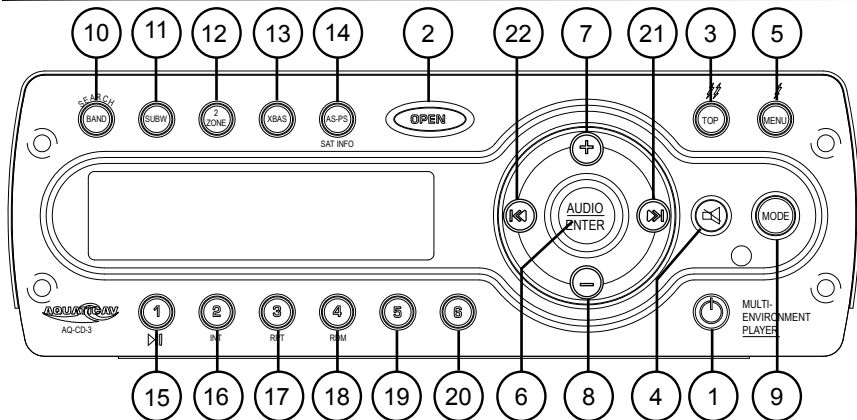
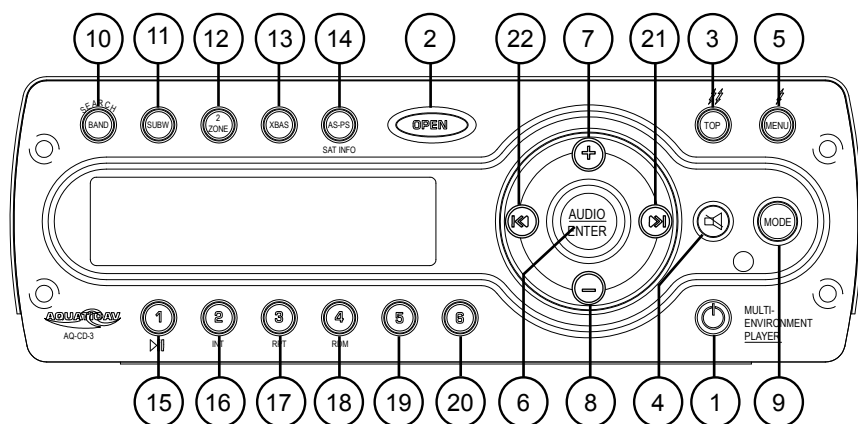

Figure 2



- **TREBLE (Treble Level):** User has 5 seconds to use the Volume Up or Down button to adjust the desired Treble level range from -6 to +6.
 - **TRE-CFQ (Treble Center Frequency):** User has 5 seconds to use the Volume Up or Down button to adjust the desired Treble center frequency to 10 KHz, 12.5 KHz, 15 KHz, or 17.5 KHz.
 - **BALANCE:** User has 5 seconds to use the Volume Up or Down button to adjust the Balance between the right and left speakers from R12 (full right) to L12 (full left). "C00" represents an equal balance between the right and left speakers.
 - **FADER:** User has 5 seconds to use Volume Up or Down button to adjust the Fader between the front and rear speakers from R12 (full rear) to F12 (full front). "C00" represents an equal balance between the front and rear speakers.
7. **Volume Up Button:** Press + (Volume Up) to increase the volume level. The volume level is shown on the display panel, ranging from 0 to 46.
 8. **Volume Down Button:** Press - (Volume Down) to decrease the volume level. The volume level is shown on the display panel, ranging from 46 to 0.
 9. **Mode Button:** Short press the Mode button to change input from XM Tuner (not used), CD, AUX, or Tuner. The mode selection is shown on the display panel.
 10. **Band Button:** Press Band to change between FM1, FM2, FM3, AM1, or AM2 bands.

11. **Sub-Woofer (SUBW) Button:** Press the SUB-W button to activate the Sub-woofer function On, and “Sub-woofer” will appear on the LCD display for 3 seconds. Press the SUB-W button again to turn off the Sub-woofer function.
12. **2 Zone Button:** The feature is not used.
13. **iX-Bass Button (XBAS) Button:** Press the iX-BASS button to turn on the iX-BASS function, and “iX-BASS” will appear in the LCD display for 3 seconds. Press the iX-BASS button again to turn off the iX-Bass function.
14. **AS/PS (Automatically Store/Preset Scan) Button:** While in seek mode the stereo unit will automatically select 6 strong stations and store them in the current band. Select a band (if needed).
 - **Preset Scan:** Scan stations stored in the current band. Select a band, press AS/PS button for less than 3 seconds. The unit will pause for ten seconds at each preset station. Press AS/PS button again to stop scanning when the desired station is reached.
 - **Stereo:** The unit will automatically pick up a stereo signal when available. When in stereo mode, the ST icon appears in the display. When no stereo signal is available, the unit will automatically revert to mono operation, and no icon will be displayed.
15. **Preset 1/Pause Play Button:** In Tuner mode, any station can be stored as preset 1 by pressing and holding this button for 2 seconds, after the desired station is selected. To recall the station preset, simply press and release this button. In CD mode, pressing this button will pause or play the CD. When inserting a CD make sure the label side is facing up.
16. **Preset 2/INT Button:** In Tuner mode, any station can be stored as preset 2 by simply pressing and holding this button for 2 seconds, after the desired station is selected. To recall the station preset, simply press and release this button. In CD mode, pressing this button will preview each song on the disc for about 10 seconds. Press again to turn off this feature or once the desired track is reached.
17. **Preset 3/RPT Button:** In Tuner mode, any station can be stored as preset 3 by simply pressing and holding this button for several seconds, after the desired station is selected. To recall the station preset, simply press and release this button. In CD mode, pressing this button will play a song repeatedly. Press again to turn off this feature.



18. **Preset 4/RDM Button:** In Tuner mode, any station can be stored as preset 4 by simply pressing and holding this button for 2 seconds, after the desired station is selected. To recall the station preset, simply press and release this button. In CD mode, press this button to randomly play song tracks. Press again to turn off this feature.
19. **Preset 5/DN Button:** In Tuner mode, any station can be stored as preset 5 by simply pressing and holding this button for 2 seconds, after the desired station is selected. To recall the station preset, simply press and release this button. In CD mode, this button will browse the folders on CD-R and CD-RW discs.
20. **Preset 6/UP Button:** In Tuner mode, any station can be stored as preset 6 by simply pressing and holding this button for 2 seconds, after the desired station is selected. To recall the station preset, simply press and release this button. In CD mode, this button will browse the folders on CD-R and CD-RW discs.
21. **Tuning Up Button:** Press and hold Track Up for more than 3 seconds to manually adjust station frequency up, Auto Seek is shown on the display panel. Short press Track Up to scan/seek for next higher station, Manual Seek is shown on the display panel. Scan mode stops as soon as a strong station is found. In CD mode, pressing this button will advance the CD up to the next track, the track number is shown on the display panel. Simply press and hold the button to fast forward through a track(s). CD play starts when the button is released.
22. **Tuning Down Button:** Press and hold Track Down for more than 3 seconds to manually adjust station frequency down. Press Track Down to scan/seek for next lower station. Scan mode stops as soon

as a strong station is found. In CD mode, pressing this button will advance the CD down to the previous track, the track number is shown on the display panel. Simply press and hold the button to rewind through a track. CD play starts when the button is released.

23. **Displaying information:** When a retail music CD is inserted, the disc will begin to play. The following information will be displayed: CD track no./Playtime

When a CD containing MP3 files is inserted, the display will change modes as follows:

- Track no./Playtime
- Folder name
- File name
- Song name
- Artist's name
- Album name

The system can only display the first 8 letters of ID3 tags. If the recorded information is longer than 8 letters, text will scroll to the left once, then the 8 first letters will be displayed. If specific info has not been recorded on an MP3 disc, NO FOLD, NO TRK, NO TLT, NO ALBM, NO ART will display.

24. **Playback Order of CD with MP3 Files:**

- A directory that does not include an MP3 file is skipped.
- We recommend that you make no more than two levels for each disc.
- Maximum number of folders: 255
- Maximum number of folder levels: 8
- Maximum number of characters for MP3 file name and folder name: 32
- Sampling frequency: (32 kHz 44.1 kHz for WMA) and (16 kHz, 22.05 kHz, 24 kHz, 32 kHz, 44.1 kHz, 48kHz for MP3)
- Bit rates: 32-320 Kbps
- MP3 decoding format: MPEG 1, 2 & 2.5 Audio Layer 3
- Folder names and file names can be displayed with up to 11 characters.
- The characters A-Z, 0-9 can be displayed on this unit, other characters may not be displayed correctly.
- ID3 tag is supported.

25. **Reading MP3 files from a disc:** When a disc containing MP3 data is loaded, the unit checks all the data on the disc. If the disc contains numerous folders with many levels or non-MP3/WMA files, it takes a longer time to start playback. In addition, it may take time for the unit to move to the next MP3 file and the fast forward function may not be performed smoothly. Loading such a media may produce loud noise and cause damage to the speakers. When selected to play, files and

folders are accessed in order in which they were written by the CD writer. Therefore, the playing order may not be the same as the order in which they are expected. For example, a disc with the following folder/file hierarchy is subject to folder select, file select and play back order as illustrated on page 55.

Note: Do not attempt to play a media containing a non-MP3/WMA file with the the MP3/WMA extension or a media containing non MP3/WMA files.

17.2 Stereo Audio Receiver Specifications

Tuner

FM tuning Range	87.5-107.9 MHz
FM Signal-to-Noise	80 dB
Stereo Separation.....	45 dB
Capture Ratio	2.0 dB
AM tuning Range.....	530.1-710 kHz
Usable Sensitivity (IEC Standard)	22.5/27.0 (μ v/dBf)

General

Power	DC 11.5 -14.4V
Pre Output Voltage	5V
Current Consumption	< 15A
Stand-By-Mode	< 1A
Maximum Mounting Angle	30° from horizontal
Fuse.....	15-Amp Mini ATM Type

17.3 CD/MP3/WMA folder/file hierarchy

When selected for play, folder search, file search or folder select, files and folders are accessed in the order in which they were written. Because of this, the order in which they are expected to be played may not match the order in which they are actually played. For example, a media with the following folder/file hierarchy is subject to folder search, file search or folder select as shown below. An outline of a media with MP3/WMA is shown below. Subfolders are shown as folders in the folder currently selected.

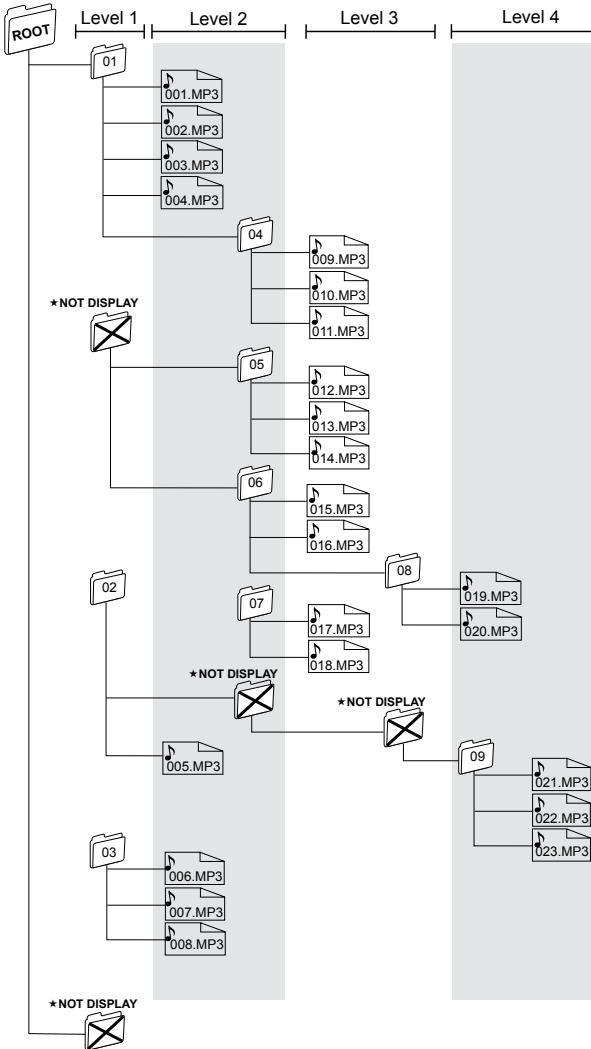

- The equipment assigns folder numbers. The user cannot assign folder numbers.
- ★ It is not possible to check folders that do not include MP3/WMA files. (These folders will be skipped without displaying the folder number and name)

A. CD/MP3/WMA File/folder play





1. There are three different play methods as following:
 - Press the M2 button more than 3 seconds during playing an MP3/WMA disc for “intro play” to all files of the current folder. Intro play should restart from the first song of the current folder, after all files in the current files have been intro-played. To disable current folder “intro play”, long press M2 button more than 3 seconds.
 - Press the M2 button less than 3 seconds is “intro play” to all files on the disc. Intro play should re-start at the very first file of the disc after all files in the disc has been intro played. To disable all files “intro play”, press M2 button less than 3 seconds.
2. File/Folder Repeat play :
 - Press the M3 button more than 3 seconds during playing MP3/WMA disc for “repeat play” for all files of the current folder and keep on repeat playing the current folder until “repeat play” is disabled. To disable current folder “repeat play”, long press M3 button more than 3 seconds.
 - Press the M3 button less than 3 seconds to “repeat play” the current file and keep on repeat playing the current file until the “repeat play” is disabled. To disable current file “repeat play”, press M3 button less than 3 seconds.
3. File/Folder Random play:
 - Press the M4 button more than 3 seconds during playing MP3/WMA disc to “random play” for all files of the current folder. To disable current folder “random play”, long press M4 button more than 3 seconds.
 - Press the M4 button less than 3 seconds is “random play” to all files on the disc. To disable all file “ random play”, press M4 button less than 3 seconds.

B. CD/MP3/WMA File or Folder Search

1. Folder/Files Navigate Searching
 - Press the BAND button. The LCD will display "Navigate", and the illumination around the select knob will blink. Rotate the knob to navigate through all folders and sub-folders on the disc. The folder names will be displayed on the LCD. Press the select knob for more than three seconds to play the first file in the folder. Press the select knob for less than three seconds to access the sub-folders or files. Rotate the select knob to navigate, then press the select knob to confirm and begin file play. During navigation search, press AS/PS or rotate the select knob counter-clockwise to move back to the last upper level of a folder.

C. ID3 information display

- For any MP3/WMA file recording with ID3 Tag information. The ID3 information such like Album title, Track title, Artist Title will be displayed and automatic scrolling through the LCD while the file is playing. User also allows pressing the AS/PS button repeatedly to view the ID3 tag information manually.

ICON	DESCRIPTION
	FOLDER ICON
	FILE ICON
	TRACK ICON
	ARTIST ICON
	ALBUM ICON

17.4 Stereo Audio Receiver Troubleshooting

Before going through the check list, check wiring connection. If any of the problems persist after check list has been made, consult your nearest service dealer.

Symptom	Cause	Solution
No power	The fuse is blown	Replace the fuse
Disc cannot be loaded or ejected	Presence of CD disc inside the player	Remove the disc in the player, then put a new one
	Inserting the disc in reverse direction	Insert the compact disc with the label facing upward
	Compact disc is extremely dirty or defective disc	Clean the disc or try to play a new one
	Condensation	Leave the player to off for an hour or so, then try again
No sound	Volume is in minimum	Adjust volume to a desired level
	Wiring is not properly connected	Check wiring connection
The operation keys do not work	The built-in microcomputer is not operating properly due to noise	Press the RESET button. Front panel is not properly fixed into its place

Sound skips.	The installation angle is more than 30 degrees	Adjust the installation angle to less than 30 degrees
	The disc is extremely dirt or defective disc	Clean the compact disc. Then try to play a new one
The radio does not work. The radio station automatic selection does not work.	The antenna cable is not connected	Insert the antenna cable firmly
	The signals are too weak	Select a station manually
ERROR	Mechanism Error	Press the eject button to correct the problem. If the error code does not disappear, consult your nearest service dealer
Disc Error	Maybe disc dirty/disc scratched/disc upside down	Replace the disc

17.5 Standard Wireless Remote Control Functions





A remote control is supplied on all spas with the optional audio system. This remote provides control over some of the radio and CD playback functions.



A. External MP3 Playback

The supplied remote control provides no control over external iPod/MP3 player operation of any kind with the exception of volume control and source selection. All external iPod/MP3 playback operations are performed solely by the iPod/MP3 player.

Wireless Remote Control Command Summary			
Button	Operation	Button	Operation
	LED Light Button: Press and hold to activate white LED light. (The light only illuminates, it has no function).		Mute Button: Press once to turn sound off (the word "MUTE" appears on the screen), press again to reactivate sound (the word "MUTE" will disappear from the screen).
	Mode Button: Press continuously to switch between Stereo, CD and Aux modes.		Menu Button: Controls most of the stereo performance functions.
	Volume Button: Used to increase volume level, between 0 to 46.		Top Button: No Function
	Volume Button: Used to decrease volume level between 46 to 0.		Power Button: Press once to turn power on to the radio, press again to turn radio off.

	<p>Seek/Track Down Button:</p> <ul style="list-style-type: none"> In CD mode: Press to rewind tracks or press and hold to do a fast rewind. In radio mode: Seeks down for stations. 		<p>Play/Pause Button: Press once to pause track, press again to resume.</p>
	<p>Seek/Track Up Button:</p> <ul style="list-style-type: none"> In CD mode: Press to move forward tracks or press and hold to do a fast forward. In radio mode: Seeks up for stations. 		<p>Band/Search Button:</p> <ul style="list-style-type: none"> In radio mode: Switches bands between FM1, FM2, FM3, AM1, and AM2.
	<p>Audio/Select Button: Controls most of the stereo sound functions.</p>		

B. Bonding the Remote and Stereo

If your remote does not operate the stereo, you may need to bond them by pressing on of the following methods:

- Press and hold the MUTE button for 5 seconds or;
- Press the four buttons MODE, MUTE, BAND/SEARCH, and TOP buttons at the corners one by one clockwise. This must be completed within two seconds.

17.6 Optional iPod®/MP3 Player Connection**A. Connecting Your iPod/MP3 Player**

1. Plug in the iPod/MP3 Player (purchased separately) with supplied mini RCA cable into the auxiliary port (Figure A).
2. Plug the other end of the supplied cable into the phone jack connection on the iPod/MP3 Player (Figure B).



Figure A



Figure B

B. Enabling iPod/MP3 Player for use

1. Select preferred song/album/play list and start playback prior to plugging in iPod/MP3 Player.
2. Press the "Mode" button on stereo receiver or the mode button on the remote until the display reads "AUX".

C. Operating iPod/MP3 Player

All playback operations are conducted via the iPod/MP3 Player. The Stereo Deck and/or Stereo Remote functions do not work on the external iPod/MP3 Player (except volume control).

**CAUTION: RISK OF ELECTRICAL SHOCK OR EQUIPMENT DAMAGE!**

Never install, remove or operate iPod/MP3 Player while hands are wet or while sitting partially or fully immersed in spa!

17.7 Wireless Remote Battery Replacement Procedure

1. Turn the remote unit over and locate the battery door (Figure A).

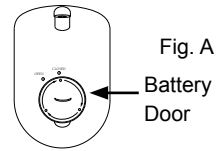

2. Rotate the battery door, with a coin, counterclockwise until the dot aligns with the Open arrow (Figure B).

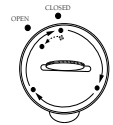

3. Remove battery door using coin to pry the door upward (Figure C).

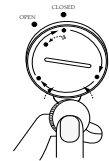

4. Replace battery using CR2430 or equivalent (Figure D).

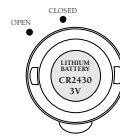

5. Reinstall the battery cover, using the coin to close (Figure E).

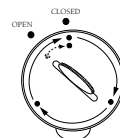

Note: Remote unit is water resistant not waterproof, therefore the unit should be stored in a dry location within your home and never be left in the spa while the cover is on and spa is not in use.

