

**LCD Series Hot Tub Owner's Manual**  
**J-460™, J-465™, J-470™, J-480™ Models**

**230 VAC, 3-Wire Connection**  
 USE COPPER CONDUCTORS ONLY. WIRE SIZE MUST BE APPROPRIATE PER NEC AND/OR LOCAL CODES.

# Attention New Spa Owner!

Congratulations on the purchase of your new Jacuzzi® spa! The following is a list of automated functions performed by your spa. These functions are listed below in an attempt to suppress any operational concerns you may have during the first 24-hours of ownership! Also listed below are important maintenance recommendations you should observe on a regular basis to protect your new investment.

## Automated Spa Operations

Your new spa is equipped with an automated “blow-out” cycle that clears all plumbing lines daily to promote maximum water sanitation. Each day at 12:00 PM (noon), pump 2 will automatically turn on for a period of one minute, then go off. Then pump 1 will turn on and run for one minute to complete the blow-out cycle. Be aware, the factory programmed blow-out cycle cannot be canceled or altered!

## Maintain Healthy Spa Water

Always maintain your spa’s water chemistry within the following parameters as defined by the Association of Pool And Spa Professionals/USA:

|                  |             |
|------------------|-------------|
| pH               | 7.4-7.6     |
| Free Chlorine    | 3.0-4.0 ppm |
| Free Bromine     | 2.0-4.0 ppm |
| Total Alkalinity | 100-120 ppm |
| Calcium Hardness | 150-250 ppm |

Always maintain your spa filter as outlined below to ensure healthy spa water. Refer to page 46-47 for additional information.

## Required Filter Maintenance

Your new spa is equipped with an advanced water filtration system that provides unsurpassed water quality! To ensure maximum water quality at all times, you should clean the skimming filter cartridge every three months, or as necessary. See page 41-43 for detailed filter cartridge cleaning instructions.

## Required Water Replacement

You should replace the spa’s water every 3 months. The frequency depends on a number of variables including frequency of use, number of users and attention paid to water quality maintenance. You will know it is time for a change when you cannot control sudsing and/or you can no longer get the normal feel or sparkle to the water, even though the key water balance measurements are all within the proper parameters. See page 46-47 for additional information.

# Table of Contents

|            |  |           |
|------------|--|-----------|
| <b>1.0</b> | <b>Important Spa Owner Information</b> .....                     | <b>1</b>  |
| <b>2.0</b> | <b>Important Safety Instructions</b> .....                       | <b>2</b>  |
| <b>3.0</b> | <b>Choosing A Location</b> .....                                 | <b>7</b>  |
| 3.1        | Outdoor Location .....   | 7         |
| 3.2        | Indoor Location .....  | 7         |
| <b>4.0</b> | <b>General Electrical Safety Instructions</b> .....              | <b>9</b>  |
| <b>5.0</b> | <b>Electrical Installation Instructions (240V Service)</b> ..... | <b>10</b> |
| <b>6.0</b> | <b>Power Requirements</b> .....                                  | <b>12</b> |
| <b>7.0</b> | <b>Spa Fill Up Procedure</b> .....                               | <b>14</b> |
| <b>8.0</b> | <b>Control Functions</b> .....                                   | <b>18</b> |
| 8.1        | Control Panel .....  | 18        |
| 8.2        | LCD Display .....  | 19        |
| 8.3        | J-480 Spa Features .....   | 20        |
| 8.4        | J-470 Spa Features .....   | 21        |
| 8.5        | J-465 Spa Features .....   | 22        |
| 8.6        | J-460 Spa Features .....   | 23        |
| <b>9.0</b> | <b>Operating Instructions</b> .....                              | <b>24</b> |
| 9.1        | View Button .....  | 24        |
| 9.2        | Activate Jets Pump 1 .....                                       | 24        |
| 9.3        | Activate Jets Pump 2 .....                                       | 24        |
| 9.4        | Selecting The Desired Massage Action .....                       | 24        |
| 9.5        | Light On/Off Button .....  | 25        |
| 9.6        | Light Mode Button .....  | 25        |
| 9.7        | Adjusting Individual Jet Flow .....                              | 26        |
| 9.8        | Adjusting PowerPro™ MX2 Jets .....                               | 26        |
| 9.9        | Adjusting RX Jets .....  | 26        |
| 9.10       | Waterfall Control .....  | 26        |
| 9.11       | Air Controls .....   | 26        |
| 9.12       | Optional Jacuzzi Audio System .....                              | 26        |
| 9.13       | J-480 Massage / Waterfall Selector Diagram .....                 | 28        |
| 9.14       | J-480 Air Controls Diagram .....                                 | 29        |
| 9.15       | J-470 Massage / Waterfall Selector Diagram .....                 | 30        |
| 9.16       | J-470 Air Controls Diagram .....                                 | 31        |
| 9.17       | J-465 Massage / Waterfall Selector Diagram .....                 | 32        |
| 9.18       | J-465 Air Controls Diagram .....                                 | 33        |
| 9.19       | J-460 Massage / Waterfall Selector Diagram .....                 | 34        |
| 9.20       | J-460 Air Controls Diagram .....                                 | 35        |

|             |  |           |
|-------------|--|-----------|
| <b>10.0</b> | <b>Heating Modes</b> .....   | <b>36</b> |
| 10.1        | Standard Mode (Factory Default).....                                   | 36        |
| 10.2        | Economy Mode .....   | 36        |
| 10.3        | Selecting Standard or Economy Mode.....                                | 36        |
| 10.4        | Clean-Up “Blow-Out” Cycle .....  | 36        |
| <b>11.0</b> | <b>Programming Instructions</b> .....                                  | <b>37</b> |
| 11.1        | Programming Filter/Circulation Pump Run Time.....                      | 37        |
| 11.2        | Programming Filter Cycles .....  | 37        |
| 11.3        | Adjusting Time of Day .....  | 39        |
| 11.4        | Main Control Panel Lock .....  | 39        |
| 11.5        | Locking Filter Cycles .....  | 40        |
| 11.6        | Temperature Setting Lock .....   | 40        |
| <b>12.0</b> | <b>Spa Maintenance</b> .....   | <b>41</b> |
| 12.1        | Cleaning The Filter Cartridges .....                                   | 41        |
| 12.2        | Draining and Refilling .....   | 43        |
| 12.3        | Cleaning The Spa Interior .....  | 44        |
| 12.4        | Pillow Care .....  | 44        |
| 12.5        | Maintaining The Synthetic Cabinet .....                                | 44        |
| 12.6        | Maintaining The Cover .....  | 45        |
| 12.7        | Winterizing.....   | 45        |
| 12.8        | Restarting Your Spa in Cold Weather .....                              | 46        |
| <b>13.0</b> | <b>Water Quality Maintenance</b> .....                                 | <b>46</b> |
| 13.1        | pH Control .....   | 47        |
| 13.2        | Sanitizing.....  | 47        |
| 13.3        | Other Additives .....  | 47        |
| 13.4        | Optional Ozone Water Maintenance System .....                          | 48        |
| <b>14.0</b> | <b>Troubleshooting - Display Messages</b> .....                        | <b>48</b> |
| <b>15.0</b> | <b>Troubleshooting - Procedures</b> .....                              | <b>51</b> |
| <b>16.0</b> | <b>US/Canada 60Hz J-460/J-465/J-470/J-480 Wiring Diagram</b> .....     | <b>53</b> |
| <b>17.0</b> | <b>Export 50Hz J-460/J-465/J-470/J-480 Wiring Diagram</b> .....        | <b>54</b> |
| <b>18.0</b> | <b>Typical Spa Wiring Diagrams A-B (US/Canada 60Hz Models Only)</b> .. | <b>55</b> |
| <b>19.0</b> | <b>Optional Jacuzzi Stereo Receiver Features</b> .....                 | <b>57</b> |
| 19.1        | General Controls .....   | 57        |
| 19.2        | Radio Operation .....  | 58        |
| 19.3        | CD Player Operation .....  | 60        |
| 19.4        | Specifications .....   | 62        |
| 19.5        | iPod Docking Station .....   | 64        |
| 19.6        | Generic MP3 Player Operation .....                                     | 65        |
| 19.7        | Troubleshooting .....  | 66        |
| 19.8        | Standard Wireless Remote Control.....                                  | 66        |

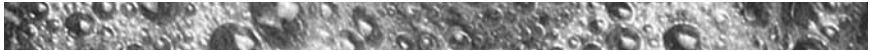

## **1.0 Important Spa Owner Information**

Your Jacuzzi® spa is constructed to the highest standards and is capable of providing many years of trouble-free use. However, because heat retentive materials are utilized to insulate the spa for efficient operation, an uncovered spa surface directly exposed to sunlight and high temperatures for an extended period is subject to permanent damage. Damage caused by exposing the spa to this abuse is not covered under warranty. We recommend that you always keep the spa full of water when it is exposed to direct sunlight and that you keep the Jacuzzi insulating cover in place at all times when the spa is not in use. Read and carefully follow the requirements for your spa's support base found in the section 3.0 titled, "Choosing A Location" (page 7).

**Jacuzzi® spas constantly strives to offer the finest spas available, therefore, modifications and enhancements may be made which affect the specifications, illustrations and/or instructions contained herein.**

### **FCC Notice**

This equipment has been tested and found to comply with the limits for a Class B Digital Device, pursuant to Part 15 of the FCC Rules. These limits are designed to provide reasonable protection against harmful interference in a residential installation. This equipment generates, uses and can radiate radio frequency energy and, if not installed and used in accordance with the instructions, may cause harmful interference to radio communications. However, there is no guarantee that interference will not occur in a particular installation. If this equipment does cause harmful interference to radio or television reception, which can be determined by turning the equipment off and on, the user is encouraged to try to correct the interference by one or more of the following measures:

1. Rearrange or relocate the receiving antenna;
2. Increase the separation between the equipment and receiver;
3. Connect the equipment into an outlet on a circuit different from the circuit connected;
4. Consult the dealer or an experienced radio/TV technician for help. (Changes or modifications not expressly approved by the party responsible for FCC compliance could void the user's authority to operate this equipment.)



## 2.0 IMPORTANT SAFETY INSTRUCTIONS

### READ AND FOLLOW ALL INSTRUCTIONS CAREFULLY

When installing and using this electrical equipment, basic safety precautions should always be followed, including:

1. **WARNING:** To reduce the risk of injury, do not permit children to use this product unless they are closely supervised at all times.
2. **WARNING:** A grounding wire connector is provided on this unit to connect a minimum No. 8 AWG (8.4mm<sup>2</sup>) solid copper conductor between this unit and any metal equipment, metal enclosures of electrical equipment, metal water pipe, or conduit within 5 feet (1.5m) of the unit.
3. **DANGER:** Risk of Accidental Drowning. Extreme caution must be exercised to prevent unauthorized access by children. To avoid accidents, ensure that children cannot use this spa unless they are supervised at all times.
4. **DANGER:** Risk of Injury. The suction fittings in this spa are sized to match the specific water flow created by the pump. Should the need arise to replace the suction fittings or the pump, be sure that the flow rates are compatible. Never operate the spa if the suction fittings are broken or missing. Never replace a suction fitting with one rated less than the flow rate marked on the original suction fitting.
5. **DANGER:** Risk of Electric Shock. Install at least 5 feet (1.5m), from all metal surfaces. As an alternative, a spa may be installed within 5 feet of metal surfaces if each metal surface is permanently connected (bonded) by a minimum No. 8 AWG (8.4mm<sup>2</sup>) solid copper conductor attached to the wire connector on the grounding lug, inside the equipment compartment on the equipment box.
6. **DANGER:** Risk of Electric Shock. Do not permit any electrical appliance, such as a light, telephone, radio, television, etc. within 5 feet of a spa unless such appliances are built-in by the manufacturer.
7. **ELECTRICAL SUPPLY:** The electrical supply for this product must include a suitably rated switch or circuit breaker to open all ungrounded supply conductors to comply with section 422-20 of the National Electrical Code/USA, ANSI/NFPA 70. The disconnect must



be readily accessible and visible to the spa occupant but installed at least 5 feet (1.5m), from the spa water.

**8. WARNING: To Reduce the Risk of Injury:**

9. The water in a spa should never exceed 104°F (40°C). Water temperatures between 100°F (38°C) and 104°F (40°C) are considered safe for a healthy adult. Lower water temperatures are recommended for young children and when spa use exceeds 10 minutes.
10. Since excessive water temperatures have a high potential for causing fetal damage during the early months of pregnancy, pregnant or possibly pregnant women should limit spa water temperatures to 100°F (38°C). If pregnant, please consult your physician before using a spa.
11. Before entering the spa, the user should measure the water temperature with an accurate thermometer since the tolerance of water temperature-regulating devices may vary as much as +/- 5°F (2°C).
12. The use of alcohol, drugs, or medication before or during spa use may lead to unconsciousness with the possibility of drowning.
13. Persons suffering from obesity or a medical history of heart disease, low or high blood pressure, circulatory system problems, diabetes, infectious diseases or immune deficiency syndromes should consult a physician before using a spa. If you experience breathing difficulties in association with using or operating your spa, discontinue use and consult your physician.
14. Persons using medication should consult a physician before using a spa since some medication may induce drowsiness, while other medication may affect heart rate, blood pressure, and circulation.
15. Always shower before and after using your spa. To reduce the possibility of contracting a waterborne illness, always maintain water chemistry within the parameters listed on the inside cover of this manual. If you or other bathers are affected by such a condition, discontinue use and seek medical attention.

**IMPORTANT CSA SAFETY INSTRUCTIONS (CANADA ONLY)**

When using this electrical equipment, basic safety precautions should always be followed, including the following:



## 1. READ AND FOLLOW ALL INSTRUCTIONS.

2. A green colored terminal or a terminal marked G, Gr, Ground, Grounding or the ⊕ symbol\* is located inside the supply terminal box or compartment. To reduce the risk of electric shock, this terminal must be connected to the grounding means provided in the electric supply service panel with a continuous copper wire equivalent in size to the circuit conductors that supply this equipment.

\*IEC Publication 417, Symbol 5019.

3. At least two lugs marked “Bonding Lugs” are provided on the external surface or on the inside of the supply terminal box/compartment. To reduce the risk of electric shock, connect the local common bonding grid in the area of the spa to these terminals with an insulated or bare copper conductor not smaller than No. 6 AWG.
4. All field-installed metal components such as rails, ladders, drains or other similar hardware within 10 feet (3m) of the spa shall be bonded to the equipment grounding buss with copper conductors not smaller than No. 6 AWG.

## 5. SAVE THESE INSTRUCTIONS.

**WARNING:** Children should not use spas without adult supervision.

**WARNING:** Do not use spas unless all suction guards are installed to prevent body and hair entrapment.

**WARNING:** People with infectious diseases should not use a spa.

**WARNING:** To avoid injury, exercise care when entering or exiting the spa.

**WARNING:** Do not use drugs or alcohol before or during the use of a spa to avoid unconsciousness and possible drowning.

**WARNING:** Pregnant or possibly pregnant women should consult a physician before using a spa.

**WARNING:** Water temperature in excess of 40°C (104°F) may be injurious to your health.





**WARNING:** Before entering the spa, measure the water temperature with an accurate thermometer.

**WARNING:** Do not use a spa immediately following strenuous exercise.

**WARNING:** Prolonged immersion in a spa may be injurious to your health.

**WARNING:** Do not permit electric appliances (such as lights, telephone, radio, television, etc.) within 5 feet (1.5m) of this spa unless such appliances are built-in by the manufacturer.

**CAUTION:** Maintain water chemistry in accordance with manufacturer's instructions.

**WARNING:** The use of alcohol or drugs can greatly increase the risk of fatal hyperthermia in spas.

## **SAVE THESE INSTRUCTIONS**

### **HYPERTHERMIA**

Prolonged immersion in hot water may induce hyperthermia. A description of the causes, symptoms, and effects of hyperthermia are as follows:

Hyperthermia occurs when the internal temperature of the body reaches a level several degrees above the normal body temperature of 98.6°F (37°C). The symptoms of hyperthermia include drowsiness, lethargy, and an increase in the internal temperature of the body. The effects of hyperthermia include:

- A. Unawareness of impending hazard;
- B. Failure to perceive heat;
- C. Failure to recognize the need to exit spa;
- D. Physical inability to exit spa;
- E. Fetal damage in pregnant women; and
- F. Unconsciousness and danger of drowning.

**A warning sign is provided in your warranty packet. Please install it at a location near your spa , where it is visible to the user of the spa. For additional or replacement signs please contact your local Jacuzzi spa dealer and reference item number #6530-082.**



## CAUTIONS

1. Persons suffering from heart disease, diabetes, high or low blood pressure, and any condition requiring medical treatment, pregnant women, the elderly, or infants should consult with a physician before using a spa.
2. The Consumer Products Safety Commission/USA has stated that the water temperature in a spa should not exceed 104°F (40°C). Immersion in water in excess of 104°F (40°C) can be hazardous to your health.
3. Observe a reasonable time limit when using the spa. Long exposures at higher temperatures can cause high body temperature. Symptoms may include dizziness, nausea, fainting, drowsiness, and reduced awareness. These effects could possibly result in drowning.
4. Do not use the spa under the influence of alcohol, narcotics, or other drugs. Use of the spa under these conditions may lead to serious consequences.
5. Always test the spa water temperature before entering the spa. Enter and exit the spa slowly. Wet surfaces can be very slippery.
6. Never bring any electrical appliances into or near the spa. Never operate any electrical appliances from inside the spa or when you are wet unless such appliances are built-in by the manufacturer.
7. Proper chemical maintenance of spa water is necessary to maintain safe water and prevent possible damage to spa components.
8. Use the straps and clip tie downs to secure the cover when not in use. This will help to discourage unsupervised children from entering the spa and keep the spa cover secure in high-wind conditions. There is no representation that the cover, clip tie-downs, or actual locks will prevent access to the spa.

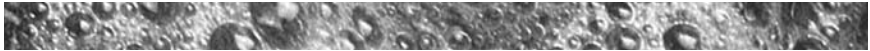

### **3.0 Choosing A Location**

**IMPORTANT:** Because of the combined weight of the spa, water and users, it is extremely important that the base upon which the spa rests be smooth, flat, level and capable of uniformly supporting this weight, without shifting or settling, for the entire time the spa is in place. If the spa is placed on a surface which does not meet these requirements, damage to the skirt and/or the spa shell may result. Damage caused by improper support is not covered under warranty. It is the responsibility of the spa owner to assure the integrity of the support at all times. We recommend a poured, reinforced concrete slab with a minimum thickness of 4 inches (10cm). Wood decking is also acceptable provided it is constructed so that it meets the requirements outlined above.

The spa must be installed in such a manner as to provide drainage away from it. Placing the spa in a depression without provisions for proper drainage could allow rain, overflow and other casual water to flood the equipment and create a wet condition in which it would sit in. For spas which will be recessed into a floor or deck, install so as to permit access to the equipment, either from above or below, for servicing. Make certain that there are no obstructions which would prevent removal of all side cabinet side panels and access to the jet components, especially on the side with the equipment bay.

#### **3.1 Outdoor Location**

In selecting the ideal outdoor location for your spa, we suggest that you take into consideration:

1. The proximity to changing area and shelter (especially in colder weather).
2. The pathway to and from your spa (this should be free of debris so that dirt and leaves are not easily tracked into the spa).
3. The closeness to trees and shrubbery (remember that leaves and birds could create extra work in keeping the spa clean).
4. A sheltered environment (less wind and weather exposure can result in lowered operation and maintenance costs).
5. The overall enhancement of your environment. It is preferable not to place the spa under an unuttered roof overhang since run-off water will shorten the life expectancy of the spa cover.

#### **3.2 Indoor Location**

For indoor installations many factors need to be considered before installing a spa indoors.



- **Proper Foundation:** Consult a Structural Engineer when considering a foundation that will adequately support the spa the entire time it is in place. Proper support is critical especially if the spa is to rest on a second story or higher. For spas that are to rest on balconies, roofs or other platforms not specifically tied into the main structural support, you should consult a professional Structural Engineer with experience in this type of application.
- **Proper Drainage:** It is extremely important to have in place measures to sufficiently handle excessive water spillage. Be sure the flooring in which the spa rests on has adequate drainage and can handle the entire contents of the spa. Be sure to make provisions for ceilings and other structures that may be below the spas installation. Areas around your spa can become wet or moist so all flooring and subsequent furniture, walls and adjacent structures should be able to withstand or resist water and moisture.
- **Proper Ventilation:** Proper ventilation should be discussed with an Engineer or authority competent enough to understand the necessary provisions needed to vent moist or heated air and air associated with chemical odors outdoors. When the spa is in use considerable amounts of moisture will escape, potentially causing mold and mildew over time which can damage certain surfaces and/or surroundings.
- **Sufficient Access:** In the unlikely event that you should ever need to access or gain entry to any portion of the spa for servicing, it is highly recommended that you plan your indoor installation to provide full access to the entire spa.
- **Warranty:** Damage caused by not following these guidelines or any improper installation not in accordance to local codes or authorities is not covered under the spas warranty. Please consult your local state or city building ordinances.



**WARNING:** In addition to maintenance of filters and water chemistry, proper ventilation is recommended to reduce the risk of exposure to viruses and bacteria that could be present in the air or water. Consult a licensed architect or building contractor to determine your specific needs if installing your spa indoors.

#### **4.0 General Electrical Safety Instructions**

Your new Jacuzzi® spa is equipped with the “state-of-the-art” Sentry™ equipment system. It contains the most advanced safety and self-protective equipment in the industry. Nonetheless, this spa must be installed properly to ensure dependable usage. Please contact your local Jacuzzi dealer or local building department should you have any questions regarding your installation.

Proper grounding is extremely important. Jacuzzi spas are equipped with a current collector system. A pressure wire connector is provided on the surface of the control box, located inside the equipment door (Figure-B, page 11) to permit connection of a bonding wire between this point and any ground metal equipment, metal water pipe or conduit within 5 feet (1.5m) of the spa, or copper clad grounding rod buried within 5 feet (1.5m) of the spa. Bonding wire must be at least No. 8 AWG (8.4 mm<sup>2</sup>) solid copper wire. This is a most important safety assurance feature.

Before installing your spa, check with your local building department to ensure installation conforms to local building codes.



## 5.0 Electrical Installation Instructions (240V Service)

**IMPORTANT NOTICE:** The electrical wiring of this spa must meet the requirements of the National Electrical Code/USA (NEC) and any applicable state or local codes. The electrical circuit must be installed by a qualified electrician and approved by a local building/electrical inspection authority.

1. This spa must be permanently connected (hard-wired) to the power supply. **No plug-in connections or extension cords are to be used in conjunction with the operation of this spa.** Supplying power to the spa which is not in accordance with these instructions will void both the independent testing agency listing and the manufacturer's warranty.
2. The power supplied to this spa must be a dedicated circuit with no other appliances or lights sharing the power provided by the circuit.
3. To determine the current, voltage and wire size required, refer to section 6.0 "Power Requirements" (page 12) for your specific spa model.
  - Wire size must be appropriate per NEC and/or local codes.
  - We recommend type THHN wire.
  - All wiring must be copper to ensure proper connections. **Do not use aluminum wire.**
  - When using wire larger than #6 (10mm<sup>2</sup>), add a junction box near the spa and reduce to short lengths of #8 (8.4mm<sup>2</sup>) wire to connect to the spa.
4. The electrical supply for this product must include a suitably rated switch or circuit breaker to open all ungrounded supply conductors to comply with Section 422-20 of the National Electrical Code/USA, ANSI/NFPA 70. The disconnecting means must be readily accessible to the spa's occupant but installed at least 5 feet (1.5m) from spa water.
5. The electrical circuit supplied for the spa must include a suitable ground fault circuit interrupter (GFCI) as required by NEC Article 680-42/USA.
6. To gain access to the spa's power terminal block, remove the four screws securing the center cabinet panel on the side of the spa under the controls. Then remove the four control box door screws and door (Figure-A).

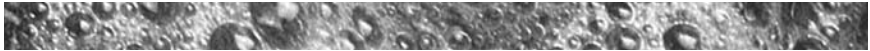

7. Select the power supply entrance you want to use (Figures A) and remove the short cabinet panel from the front of the spa to allow you to feed the cable through to the control box. Install the cable with connector through the large opening provided in the bottom of the control box.
8. Connect wires, color to color, on terminal blocks TB1 and TB3 (Figure C-D, page 12). TIGHTEN SECURELY! All wires must be hooked up securely or damage could result.
9. Install control box door and reinstall the cabinet side panels.

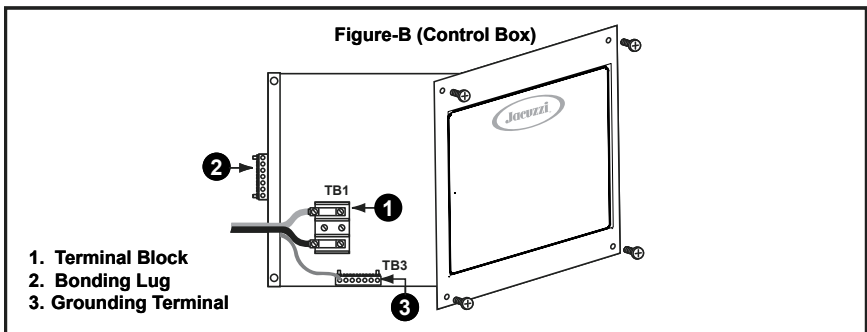
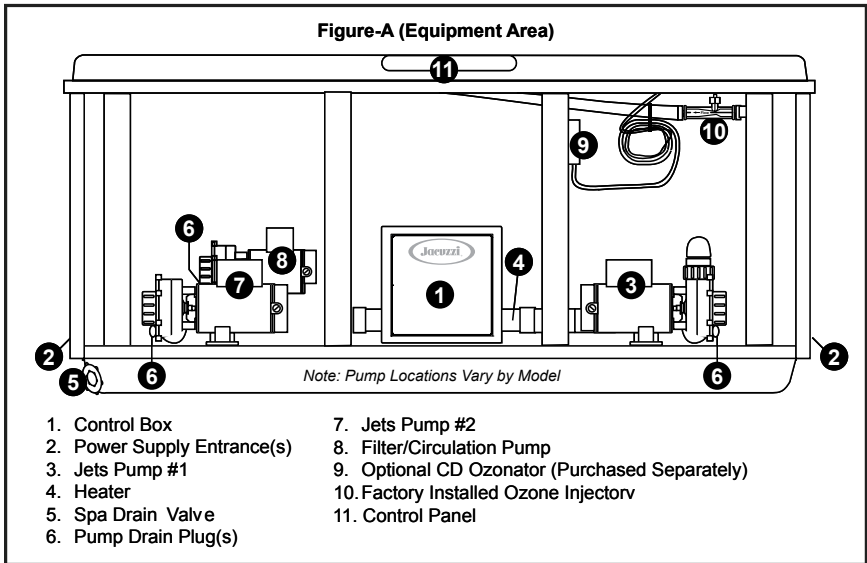

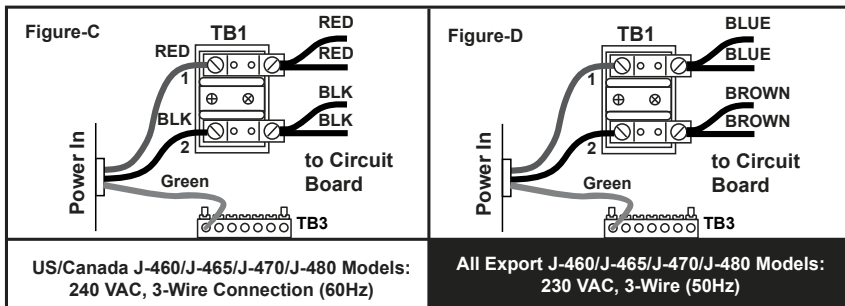

## 6.0 Power Requirements

Jacuzzi® spas are designed to provide optimum performance and flexibility of use when connected to their maximum electrical service. However, they are shipped factory configured for their most common preferred electrical connection as follows:

- All US/Canada 60Hz Models: 240VAC/50A\*\*
- All Export 50Hz Models: 240VAC/30A\*\*

If you prefer, your qualified technician can perform a minor circuit board modification that allows the hot tub to operate on a different electrical service (see table footnotes below).

| US/Canada J-460/J-465/J-470/J-480 Models (60Hz)  |        |        |        |
|--|--------|--------|--------|
| Voltage:   | 240VAC | 240VAC | 240VAC |
| Max. Current Draw:   | 23A    | 36A    | 45A    |
| Frequency:   | 60Hz   | 60Hz   | 60Hz   |
| Number of Wires:   | 3      | 3      | 3      |
| Circuit Breaker (2-Pole):  | 30A*   | 50A**  | 60A*** |
| <p>* In 30A configuration, the heater <b><u>will not operate</u></b> while either jets pump is running.</p> <p>** In 50A configuration, the heater <b><u>will not operate</u></b> while both jets pumps are running. <b><i>This is the factory setting.</i></b></p> <p>*** In 60A configuration the heater <b><u>will operate</u></b> while both jets pumps are running.</p> |        |        |        |





### Export J-460/J-465/J-470/J-480 Models (50Hz)

|                           |        |        |        |
|---------------------------|--------|--------|--------|
| Voltage:                  | 240VAC | 240VAC | 240VAC |
| Max. Current Draw:        | 16A    | 21A    | 29A    |
| Frequency:                | 50Hz   | 50Hz   | 60Hz   |
| Number of Wires:          | 3      | 3      | 3      |
| Circuit Breaker (2-Pole): | 20A*   | 30A**  | 40A*** |

- \* In 20A configuration, the heater will not operate while either jets pump is running.
- \*\* In 30A configuration, the heater will not operate while both jets pumps are running. ***This is the factory setting.***
- \*\*\* In 40A configuration the heater will operate while both jets pumps are running.



## 7.0 Spa Fill Up Procedure

FOR BEST RESULTS, READ EACH STEP IN ITS ENTIRETY BEFORE PROCEEDING WITH THAT STEP.

### 1. Prepare The Spa For Filling

- Clear all debris from the spa. (Although the spa shell has been polished at the factory, you may want to treat it with a specially formulated spa cleaner. Consult your authorized Jacuzzi dealer for additional information prior to filling spa.
- Remove both ProClear™ skimming and polishing filter lids and filters as illustrated in section 12.1 (page 41).

### 2. Fill Spa

- Place the end of your garden hose into empty skimming filter bucket (filter bucket on your left) as you stand next to the spa. Fill spa half way, then place the garden hose into the opposite filter bucket (filter bucket on your right) while adding the remaining fill water.



**CAUTION:** Never fill with water from a water softener. If your water is extremely “hard”, it is preferable to fill half-way with hard water and the rest of the way with softened water. Or, you may fill entirely with hard water if you use a special water additive available from your authorized Jacuzzi dealer.

- Fill spa until water level is above all jets and just touching the bottom of each headrest in its lowest position. DO NOT OVERFILL!



**IMPORTANT:** Always fill your spa through both filter buckets after draining. Failure to do so may cause air to be trapped in either pump, preventing the pump from circulating water. Remove the hose and replace both filter cartridges as illustrated in section 12.1 (page 41).

### 3. Turn On Power

Turn on power to spa at the home's circuit breaker. The heater and filter/circulation pump will automatically activate. If the control panel LCD flashes water temperature and “COOL” or “ICE”, this is normal. Refer to page 48-50 for additional information.

### 4. Activate Jets Pumps

Turn on all jets(s) pumps when adding chemicals in step 5.

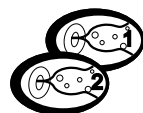

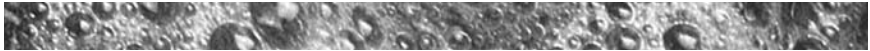

## 5. Add Start-Up Chemicals





Add the spa water chemicals as recommended by your authorized Jacuzzi spa dealer. See section titled “Water Quality Maintenance” (page 46) for general guidance.

## 6. Establish A Stable Sanitizer Reading

Establish a stable sanitizer reading between 3.0-4.0 ppm Chlorine or 2.0-4.0 ppm Bromine. To ensure healthy water conditions, always maintain a constant sanitizer reading within the levels recommended by the Association of Pool And Spa Professionals/USA printed on the inside cover of this manual. If sanitizer levels cannot be stabilized, perform the decontamination procedure steps 9-15 on the following page. *Note: the “decontamination procedure” steps 9-15 should also be used after the spa has been “Winterized” (sec. 12.7, page 45) or has been sitting without power for an extended period.*

## 7. Set Spa To Heat

To warm spa water to a comfortable temperature, follow these steps:

- The LCD display on the control panel displays the actual temperature of the spa water. Press either the **COOLER**  or **WARMER**  button once to display the “set” temperature for 5 seconds. If you want the water to heat to a different temperature, simply press **COOLER**  or **WARMER**  within 5 seconds. The set temperature increases or decreases by one degree each time one of these buttons is pressed.
- The heater will turn off when the temperature corresponding to the thermostat setting is achieved.



### Important Heater Details:

- The maximum temperature for which the spa can be set is 104°F (40°C) and the minimum is 80°F (27°C).
- For US/Canada spas powered by a service of less than 60 amps, turn off jets pump #1 and jets pump #2 to operate heater.
- Setting the thermostat at maximum will not accelerate the heating process. This will only result in a higher ultimate temperature.
- The heater operates until the water reaches the programmed “set temperature”, then turns off. The heater will reactivate after the water cools to approximately 1.5° below the “set temperature.”

## 8. Place Cover On Spa

- Keeping the insulating cover in place anytime the spa is not in use will reduce the time required for heating, thereby minimizing operating costs.



- The time required for initial heat-up will vary depending on the starting water temperature.



**DANGER:** Risk of injury! Always check water temperature carefully before entering spa!

**Decontamination Procedure (Steps 9-15)**

Steps 9-15 below are only required when sanitizer levels are unstable after performing steps 1-6 above. Disregard steps 9-15 below if sanitizer levels remain stable at 3.0-4.0 Chlorine or 2.0-4.0 Bromine ppm after performing steps 1-6 above.

9. Add 2.5 ounces of Sodium Dichlor for every 100 gallons of water. Refer to the table below for approximate water fill volume by model.



**CAUTION:** Never add Chlorine tablets (Trichlor) to your spa for any reason! This chemical may damage components within your spa and void the manufacturer warranty.

**Water Fill Volume by Model**

| Spa Model   | Approximate Fill Volume       |
|-------------|-------------------------------|
| J-460 ..... | 320 US Gallons (1,210 Liters) |
| J-465 ..... | 340 US Gallons (1,287 Liters) |
| J-470 ..... | 410 US Gallons (1,552 Liters) |
| J-480 ..... | 450 US Gallons (1,703 Liters) |

10. Leave spa cover open during this step to allow excessive chemical vapors to exit spa, protecting pillows and plastic knobs from chemical attack. If spa is indoors, open doors and windows for proper ventilation. Turn on all spa jets pumps for one hour, open all air controls, and place all massage selector knob(s) in their center “combo” position as shown (right). *Note: You will need to press the jets pump button(s) every 20 minutes since these functions have an automatic 20 minute time-out that turns them off.*

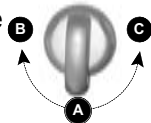

**CAUTION:** Never leave your spa unattended for any reason while the cover is open and accessible to small children and animals!

11. Turn off power to the spa at the circuit breaker, then drain tub as outlined in section 12.2 (page 43).



12. Refill spa with clean tap water from garden hose until water covers all jets but does not touch the bottom of the lowest headrest with all headrests in their lowest position (DO NOT OVERFILL!)



**CAUTION:** Never fill with water from a water softener. If your water is extremely “hard”, it is preferable to fill half-way with hard water and the rest of the way with softened water. Or, you may fill entirely with hard water if you use a special water additive available from your authorized Jacuzzi dealer.

13. Consult your authorized Jacuzzi dealer for chemical recommendations, then add chemicals to spa water to achieve a constant sanitizer reading within the levels recommended by the Association of Pool And Spa Professionals/USA printed on the inside cover of this manual.
14. Turn on all jet pumps when adding chemicals to ensure proper mixing and leave your spa cover open until the sanitizer level falls below 4.0 ppm to protect pillows and plastic knobs from chemical attack.



**CAUTION:** Never leave your spa unattended for any reason while the cover is open and accessible to small children and animals!



**CAUTION:** To prevent the unlikely possibility of contracting a waterborne illness, maintain water chemistry within step 6 parameters. If you or other bathers experience such a condition, discontinue use and seek medical attention.

15. Establish a sanitizer reading between 3.0-4.0 ppm Chlorine or 2.0-4.0 ppm Bromine, then allow the spa to set undisturbed for 8 hours. Retest water after 8 hours to determine if sanitizer levels are stable. If sanitizer levels are stable, your spa is ready for use. To ensure healthy water conditions, always maintain a constant sanitizer reading within the levels recommended by the Association of Pool And Spa Professionals/USA printed on the inside cover of this manual. If sanitizer levels are not stable at this time, it will be necessary to repeat this procedure in its entirety (steps 1-15) until stable sanitizer readings are achieved.



## 8.0 Control Functions

### 8.1 Control Panel

#### A. **Select Button:**

Filter cycle programming features.

#### B. **Cycle Button:**

Accesses filter cycle program mode and next cycle.

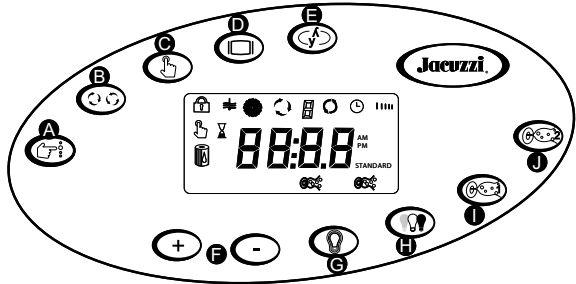

*\*Display shown for example purposes only, actual water temperature will vary.*

#### C. **Mode Button:**

Switches between standard and economy filtration/heating modes sections.

**D. Display Button:** Displays time of day and initiates time setting and locking functions.

**E. Invert Button:** Inverts the main 4-digit LCD display.

**F. Warmer and Cooler Buttons:** These buttons display, increase or decrease the temperature setting. They also display other programmable features.

**G. Light On/Off Button:** Turns waterfall, footwell and logo lights on in unison. Press once for high intensity; press a second time for medium intensity; press a third time for low intensity; press a fourth time to turn off. The displayed color is changed using the light mode button (H) below.

**H. Light Mode Button:** Selects one of 5 color modes for waterfall, footwell, and logo lights. See page 25 for additional information.

**I. JETS 1 Button:** Controls jets pump #1 (On, Off).

**J. JETS 2 Button:** Controls jets pump #2 (On, Off).

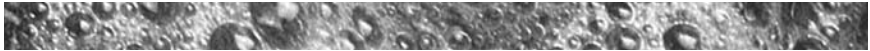



## 8.2 LCD Display

 = **Lock:** Indicates panel, set temperature, or filter cycle programming is locked.

 = **Heat:** Indicates heater is on.

 = **Ozone:** Indicates optional CD ozonator is on.

 = **Adjust Filter Cycle:** Indicates filter cycle programming feature is accessed.

 = **Filter Cycle Number:** Indicates which programmed filter cycle is running.

 = **Filter Cycle:** Indicates programmed filter cycle is running.

 = **Filter Cycle Start Time:** Indicates filter cycle start time programming is accessed.

 = **Filter Cycle Duration:** Indicates filter cycle duration programming is accessed.

 = **Set Temperature:** Indicates the current set temperature is displayed.

 = **Set Time:** Indicates current time is displayed.

 = **Filter Annunicator:** Indicates filter cleaning and/or replacement.

 = **Jets 1:** Indicates jets pump 1 is on.

 = **Jets 2:** Indicates jets pump 2 is on.

**STANDARD** = **Mode:** Indicates selected filter mode. Note: No icon means Economy mode is selected.

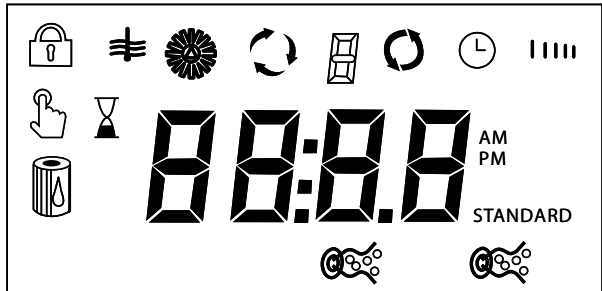



### 8.3 J-480 Spa Features

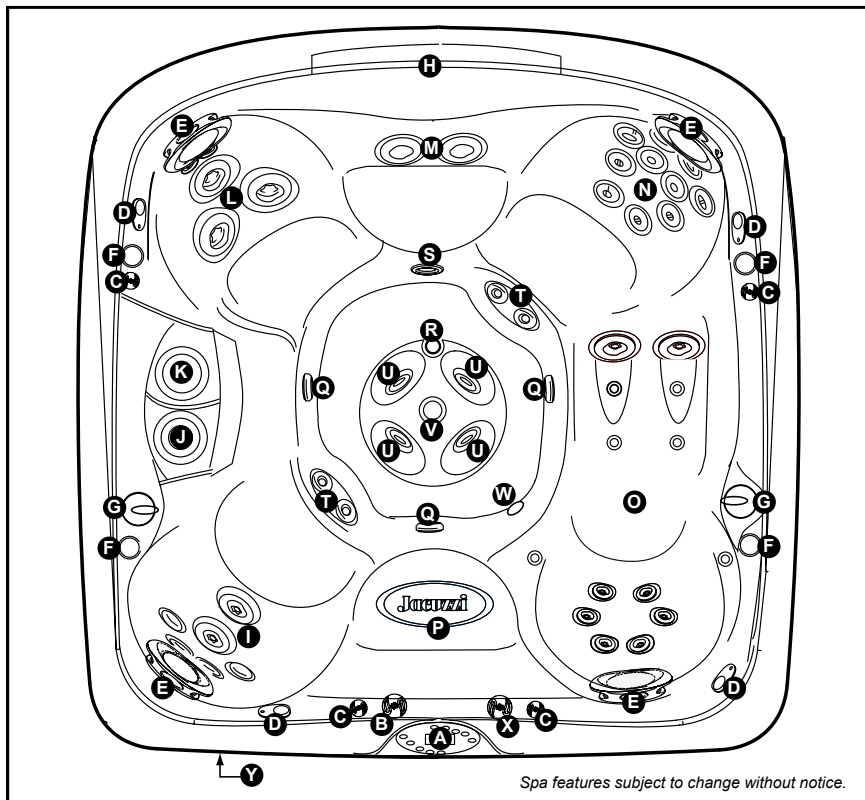

*Spa features subject to change without notice.*

- |   |   |
|---|---|
| <ul style="list-style-type: none"> <li>A. Control Panel</li> <li>B. Waterfall Control Valve</li> <li>C. Air Control Valves (4 ea.) Introduce Air to Specified Jet Groups (Page 29)</li> <li>D. Optional Audio System Speakers (4 ea.)</li> <li>E. Adjustable Pillows (4 ea.)</li> <li>F. Cup Holders (4 ea.)</li> <li>G. Massage Selectors (2 ea.) Controls Specified Jet Groups (Page 28)</li> <li>H. Waterfalls (2 ea.)</li> <li>I. FX Jets (4 ea.) And FX2 Jets (2 ea.)</li> <li>J. ProClear™ Plus Polishing Filter Bag</li> <li>K. ProClear™ Floating Skimmer And Filter Cartridge with Integrated Chemical Dispenser.</li> <li>L. NX Jets (2 ea.) And MX2 Jets (3 ea.)</li> <li>M. FX2 Jets (2 ea.)</li> </ul> | <ul style="list-style-type: none"> <li>N. NX Jets (2 ea.) And RX Jets (10 ea.)</li> <li>O. Lounge Jets:               <ul style="list-style-type: none"> <li>A. FX Back Jets (6 ea.)</li> <li>B. BX Jet for Wrists And Calves (6 ea.)</li> </ul> </li> <li>P. FX2 Foot Jets (2 ea.)</li> <li>Q. Lighted Seat Logo</li> <li>R. Footwell Filter Suction Covers (3 ea.)</li> <li>S. Bottom Filter Suction Cover</li> <li>T. Waterfall Filtration Return</li> <li>U. FX Calf Jets (4 ea.)</li> <li>V. FX Footwell Jets (4 ea.)</li> <li>W. Lighted IX Mass Aspiration Jet</li> <li>X. Gravity Drain/Heater Input/Optional Ozone Return Fitting</li> <li>Y. Lighted Mass Aspiration Jet Flow Control Valve</li> <li>Z. Optional Audio System Receiver</li> </ul> |
|---|---|



## 8.4 J-470 Spa Features

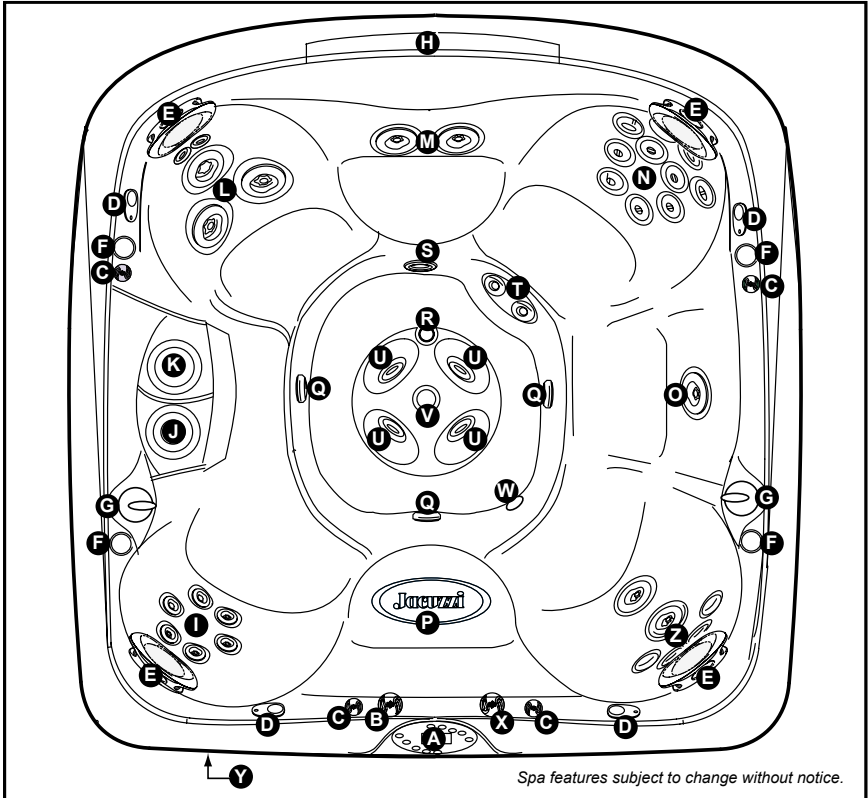

- |  |  |
|--|--|
| <p>A. Control Panel</p> <p>B. Waterfall Control Valve</p> <p>C. Air Control Valves (4 ea.) Introduce Air to Specified Jet Groups (Page 31)</p> <p>D. Optional Audio System Speakers (4 ea.)</p> <p>E. Adjustable Pillows (4 ea.)</p> <p>F. Cup Holders (4 ea.)</p> <p>G. Massage Selectors (2 ea.) Controls Specified Jet Groups (Page 30).</p> <p>H. Waterfalls (2 ea.)</p> <p>I. FX Jets (6 ea.)</p> <p>J. ProClear™ Plus Polishing Filter Bag</p> <p>K. ProClear™ Floating Skimmer And Filter Cartridge with Integrated Chemical Dispenser.</p> <p>L. NX Jets (2 ea.) And MX2 Jets (3 ea.)</p> <p>M. FX2 Jets (2 ea.)</p> | <p>N. NX Jets (2 ea.) And RX Jets (10 ea.)</p> <p>O. FX2 Jet</p> <p>P. Lighted Seat Logo</p> <p>Q. Footwell Filter Suction Covers (3 ea.)</p> <p>R. Bottom Filter Suction Cover</p> <p>S. Waterfall Filtration Return</p> <p>T. FX Calf Jets (2 ea.)</p> <p>U. FX Footwell Jets (4 ea.)</p> <p>V. Lighted IX Mass Aspiration Jet</p> <p>W. Gravity Drain/Heater Input/Optional Ozone Return Fitting</p> <p>X. Lighted Mass Aspiration Jet Flow Control Valve</p> <p>Y. Optional Audio System Receiver</p> <p>Z. FX Jets (4 ea.) and FX2 Jets (2 ea.)</p> |
|--|--|



## 8.5 J-465 Spa Features

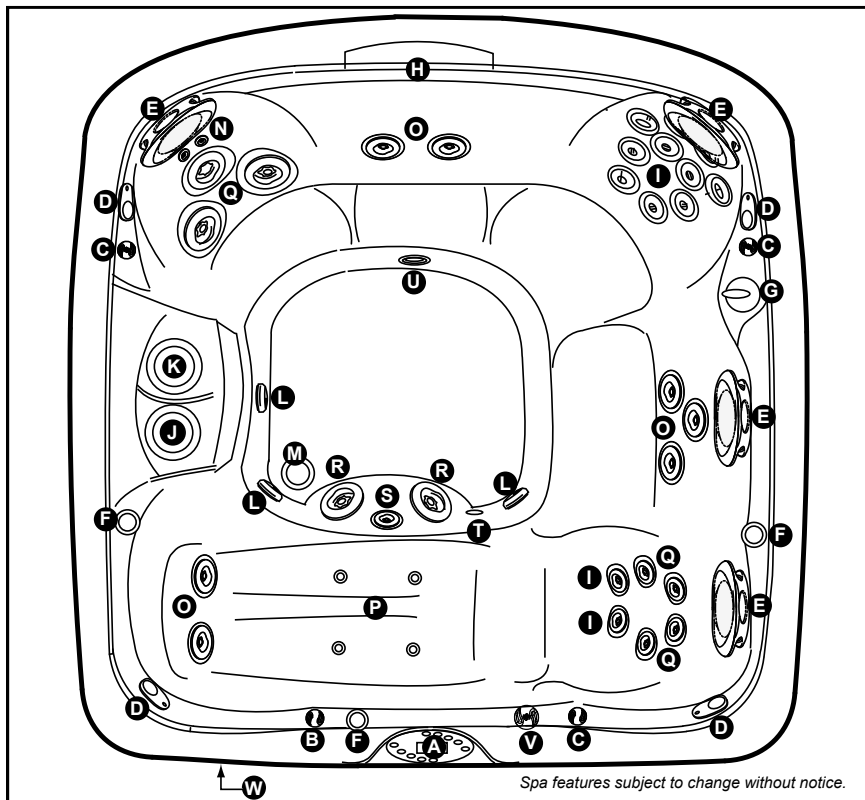

*Spa features subject to change without notice.*

- |  |   |
|--|---|
| A. Control Panel   | L. Footwell Filter Suction Covers (3 ea.)                   |
| B. Waterfall Control Valve   | M. Bottom Filter Suction Cover                              |
| C. Air Control Valves (3 ea.) Introduce Air to Specified Jet Groups (Page 33)          | N. NX Jets (2 ea.)  |
| D. Optional Audio System Speakers (4 ea.)  | O. FX2 Jets (7 ea.)   |
| E. Adjustable Pillows (4 ea.)  | P. BX Jets (4 ea.)  |
| F. Cup Holders (3 ea.)   | Q. RX Jets (4 ea.)  |
| G. Massage Selectors (1 ea.) Controls Specified Jet Groups (Page 32).                  | R. MX Jets (5 ea.)  |
| H. Waterfall   | S. Lighted IX Mass Aspiration Jet                           |
| I. FX Jets (14 ea.)  | T. Gravity Drain/Heater Input/Optional Ozone Return Fitting |
| J. ProClear™ Plus Polishing Filter Bag   | U. Waterfall Filtration Return                              |
| K. ProClear™ Floating Skimmer And Filter Cartridge with Integrated Chemical Dispenser. | V. Lighted Mass Aspiration Jet Flow Control Valve           |
|  | W. Optional Audio System Receiver                           |



## 8.6 J-460 Spa Features

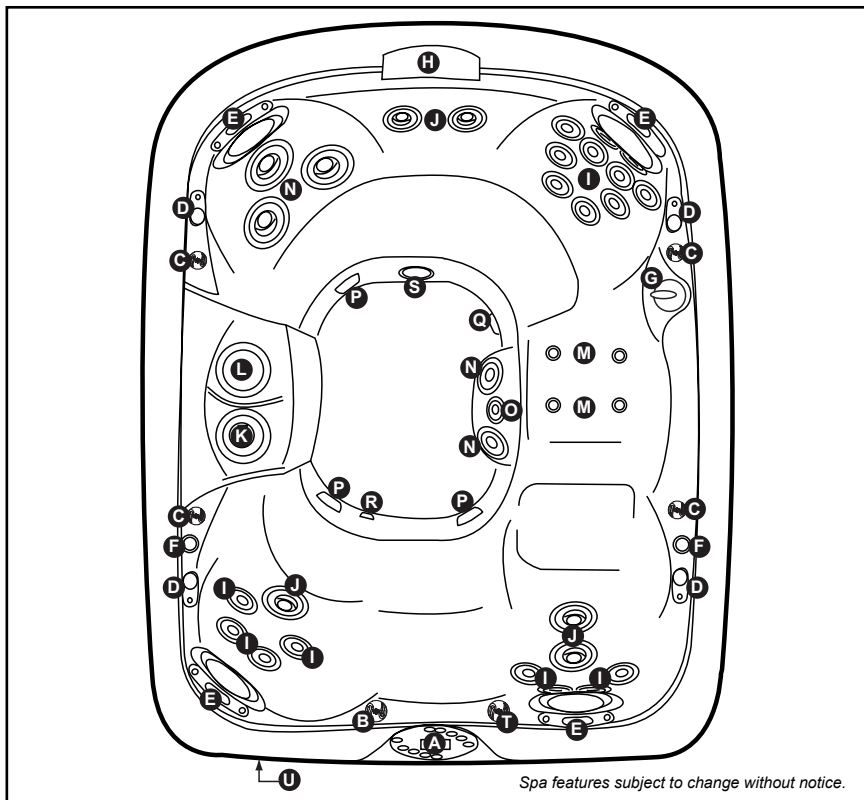

- A. Control Panel
- B. Waterfall Control Valve
- C. Air Control Valves (4 ea.)  
Introduce Air to Specified Jet Groups (Page 35)
- D. Optional Audio System Speakers (4 ea.)
- E. Adjustable Pillows (4 ea.)
- F. Cup Holders (2 ea.)
- G. Massage Selector (1 ea.) Controls Specified Jet Groups (Page 34).
- H. Waterfall
- I. FX Jets (18 ea.)
- J. FX2 Jets (5 ea.)
- K. ProClear™ Plus Polishing Filter Bag
- L. ProClear™ Floating Skimmer And Filter Cartridge with Integrated Chemical Dispenser.
- M. BX Jets (4 ea.)
- N. MX2 Jets (5 ea.)
- O. Lighted IX Mass Aspiration Jet
- P. Footwell Filter Suction Covers (3 ea.)
- Q. Bottom Filter Suction Cover
- R. Gravity Drain/Heater Input/Optional Ozone Return Fitting
- S. Waterfall Filtration Return
- T. Lighted Mass Aspiration Jet Flow Control Valve
- U. Optional Audio System Receiver



## 9.0 Operating Instructions

Your Jacuzzi® spa has a touch-sensitive control panel, massage selectors, and air control knobs located on the top rim of the spa (page 20-23). These controls let you operate many of the special functions of your Jacuzzi spa. By familiarizing yourself with the following information, you will be able to gain the full benefit from using your spa .

### 9.1 View Button

Pressing this button inverts the main four-digit display on the command center's LCD screen to allow easy reading from either inside or outside the spa.



### 9.2 Activate Jets Pump 1

The button labeled JETS 1 controls jets pump #1. Pressing this button cycles jets pump #1 on and off.



### 9.3 Activate Jets Pump 2

The button labeled JETS 2 controls jets pump #2. Pressing this button cycles pump #2 on and off.



**Auto Turn Off** — Anytime a pump has been manually turned on, it will automatically turn off after approximately 20 minutes. If at this time you desire more jet operation you may simply turn the pump(s) back on.

### 9.4 Selecting The Desired Massage Action

Your Jacuzzi spa is equipped to allow you to customize the massage action you desire. Each model incorporates a massage selector that allow you to customize the massage and performance by diverting water between various jet systems. Simply turn massage selector to position A (Combo), B, or C to divert water pressure to various jet groups. *Note: The massage selector valve(s) is designed to operate in positions A (Combo), B, and C for optimum performance. It is considered normal for sound levels within the valve to vary between positions due to the large amounts of water flowing through it! For optimum filtration benefits, leave the valve in position A when spa is covered. Select position B or C for maximum jet performance during spa use.*

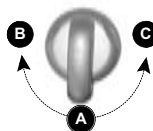



### 9.5 Light On/Off Button

Pressing this button activates the logo, footwell IX Jet light, waterfall lights, and optional exterior lights in sequence as follows: high - medium - low - off. *Note: Interior lights automatically turn off after 1 hour. Exterior lights are photocell activated.*



### 9.6 Light Mode Button

This button offers 5 light modes for your enjoyment. Press this button to select your favorite lighting effect as follows:

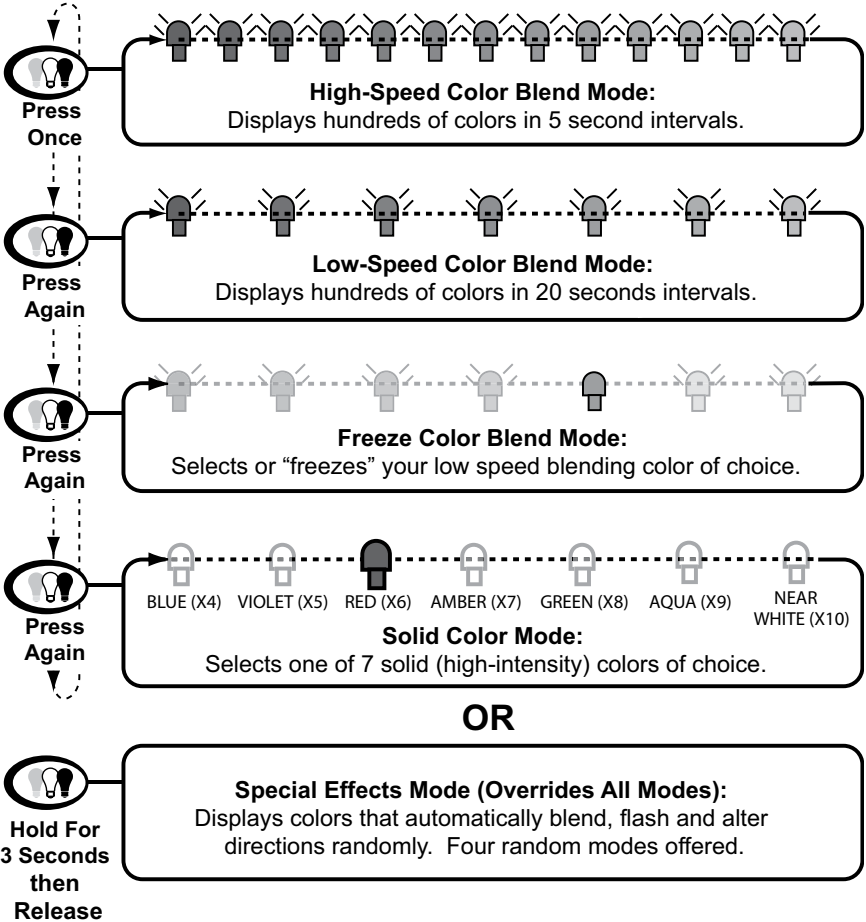

*Note: All modes are automatically recalled when the hot tub lights are turned off and back on within 5 minutes, otherwise they default to the high-speed blending mode. Solid color mode is retained indefinitely unless set otherwise or a power outage occurs.*



## 9.7 Adjusting Individual Jet Flow

The water flow to certain jets in your spa can be increased or decreased by rotating the outside jet face. *Note: Always keep at least 6 adjustable jets open at all times.*



## 9.8 Adjusting PowerPro™ MX2 Jets

Tilt PowerPro MX2 Jet nozzle to angle of choice as desired. Rotate nozzle clockwise to reduce flow volume from jet or rotate counterclockwise to increase flow volume. *Note: Always keep at least 6 adjustable jets open at all times.*



## 9.9 Adjusting RX Jets

Turn center jet adjustment knob clockwise to decrease or shut off water flow. Turn center jet adjustment knob counterclockwise to turn on or increase water flow. *Note: Always keep at least 6 adjustable jets open at all times.*



## 9.10 Waterfall Control

Turn waterfall control valve (page 28-35) counterclockwise to increase waterfall output. Turn control valve clockwise to decrease or turn off waterfalls.



## 9.11 Air Controls

Certain jet systems have their own air control. Each control introduces air into the water lines that supply that specific jet group (page 28-35). Simply rotate any air control clockwise to open or rotate counterclockwise to close. To minimize heat loss, all air controls should be closed when the spa is not in use.



## 9.12 Optional Jacuzzi Audio System

Jacuzzi models equipped with the optional Jacuzzi sound system offer enhanced spa enjoyment.

These models include an integrated AM/FM/CD/MP3 Player receiver with four high-quality marine speakers for unsurpassed sound quality and long-life. The included wireless remote control further enhances spa enjoyment by providing full sound





and jets control at your fingertips. Note: Each speaker has an integrated infrared sensor which responds to commands from the wireless remote control. Refer to section 19.0 (page 57) for complete stereo operation details.



### 9.13 J-480 Massage / Waterfall Selector Diagram

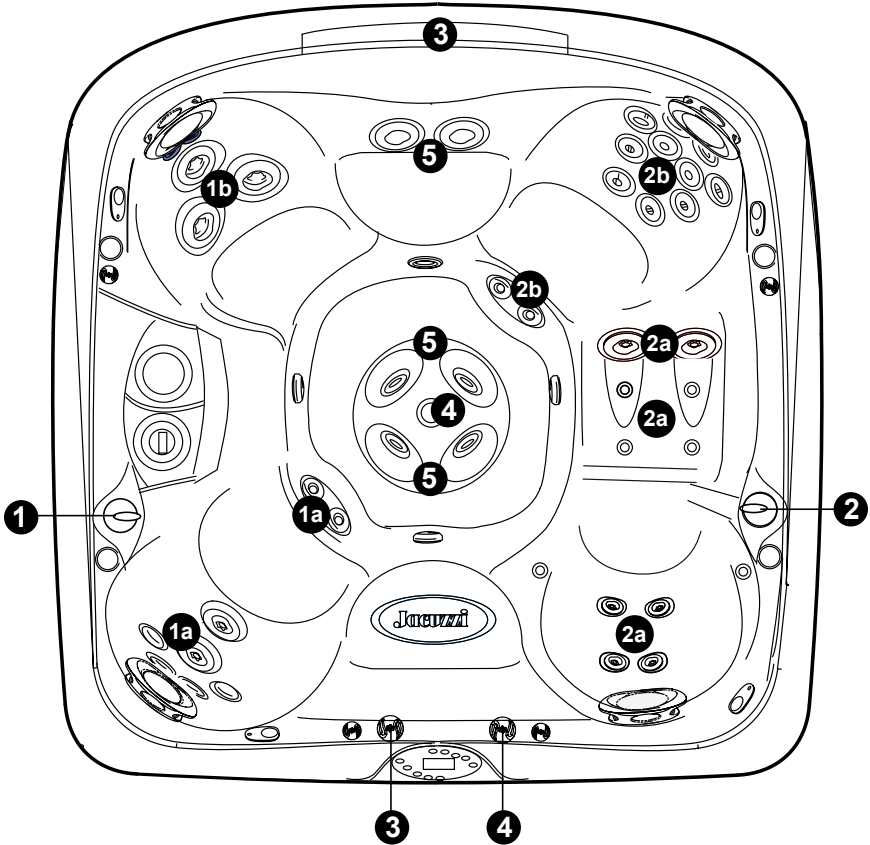

*Spa operation subject to change without notice.*

#### **Massage Selectors (1-2)**

- Massage selector 1 diverts pump 2 output between jets groups 1a-1b.
- Massage selector 2 diverts pump 1 output between jet groups 2a-2b.

#### **Waterfall Selector (3)**

- Waterfall selector 3 controls circulation pump output to waterfalls.

#### **Massage Selector (4)**

- Massage selector 4 controls pump 1 output to footwell IX Jet.

#### **Jets Without Massage Selector Controls (5)**

- Jets 5 are always on when jets pump 2 is running.





## 9.14 J-480 Air Controls Diagram

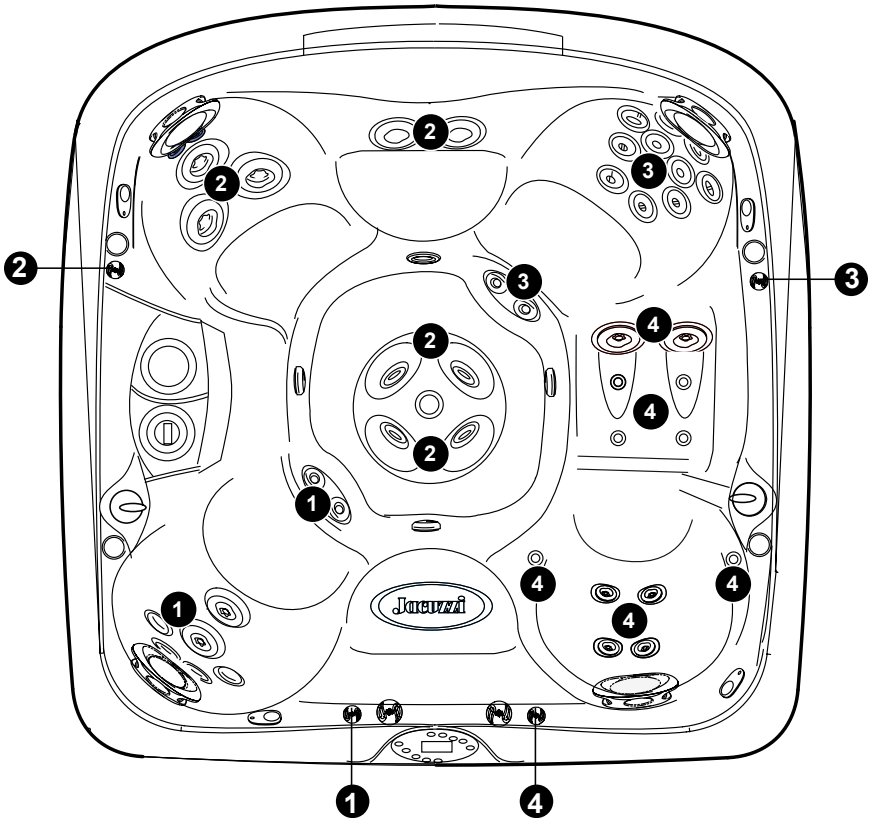

*Spa operation subject to change without notice.*

### **Air Controls Operation**

- Rotate air controls 1-4 to add air to designated jet groups.
- Center footwell IX Jet draws air at all times when jets pump 1 is running. This jet has no air control.

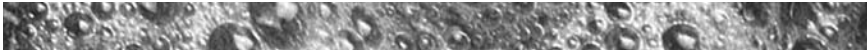

## 9.15 J-470 Massage / Waterfall Selector Diagram

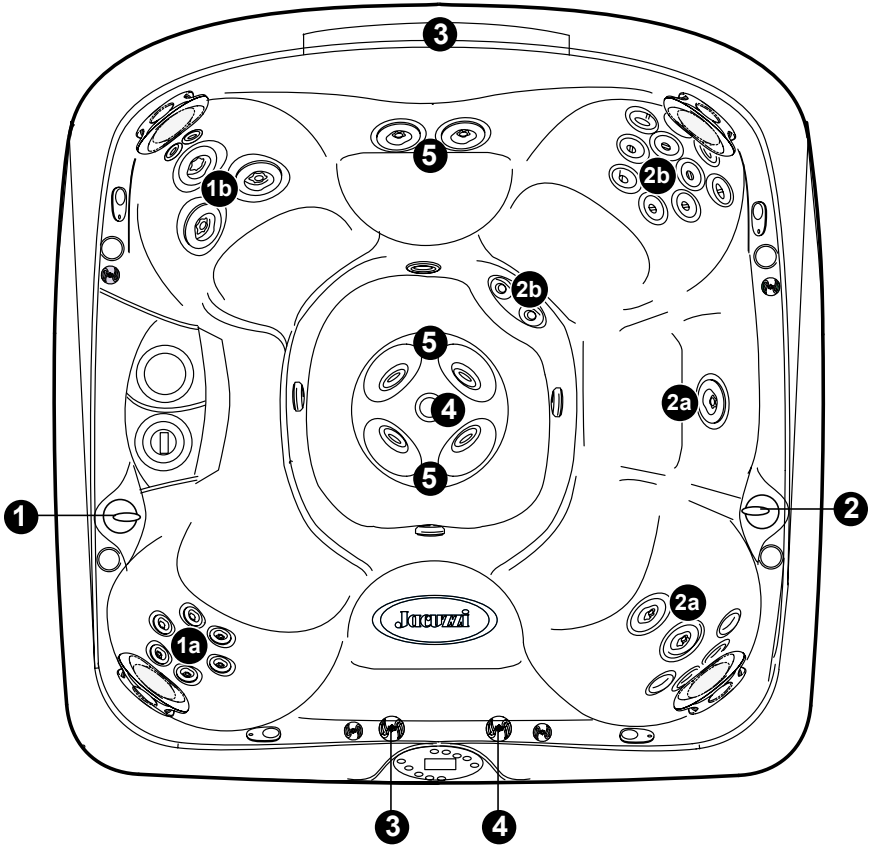

*Spa operation subject to change without notice.*

### **Massage Selectors (1-2)**

- Massage selector 1 diverts pump 2 output between jets groups 1a-1b.
- Massage selector 2 diverts pump 1 output between jet groups 2a-2b.

### **Waterfall Selector (3)**

- Waterfall selector 3 controls circulation pump output to waterfalls.

### **Massage Selector (4)**

- Massage selector 4 controls pump 1 output to footwell IX Jet.

### **Jets Without Massage Selector Controls (5)**

- Jets 5 are always on when jets pump 2 is running.



## 9.16 J-470 Air Controls Diagram

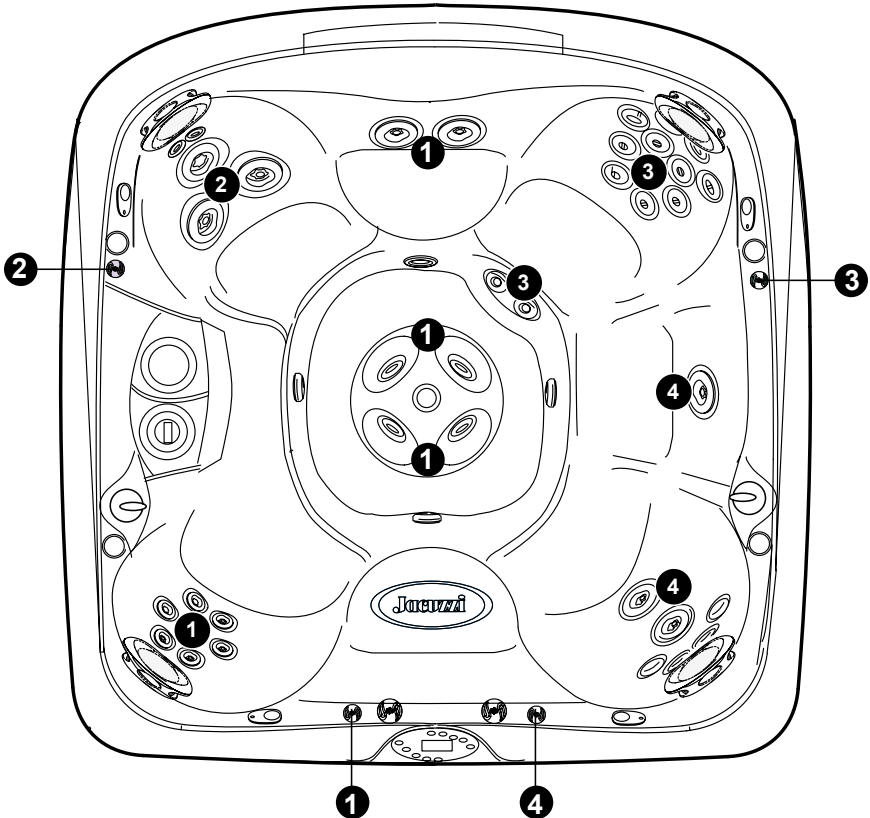

*Spa operation subject to change without notice.*

### **Air Controls Operation**

- Rotate air controls 1-4 to add air to designated jet groups.
- Center footwell IX Jet draws air at all times when jets pump 1 is running. This jet has no air control.



## 9.17 J-465 Massage / Waterfall Selector Diagram

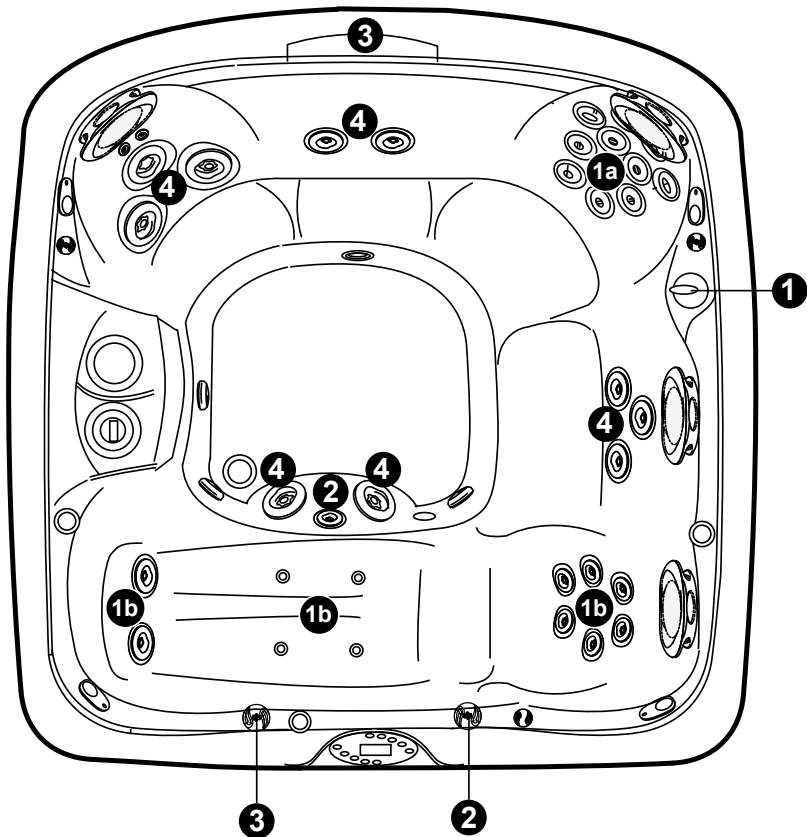

*Spa operation subject to change without notice.*

### **Massage Selectors (1)**

- *Massage selector 1 diverts pump 1 output between jets groups 1a-1b.*

### **Massage Selector (2)**

- *Massage selector 2 controls pump 1 output to footwell IX Jet.*

### **Waterfall Selector (3)**

- *Waterfall selector 3 controls circulation pump output to waterfall.*

### **Jets Without Massage Selector Controls (4)**

- *Jets 4 are always on when jets pump 2 is running.*



## 9.18 J-465 Air Controls Diagram

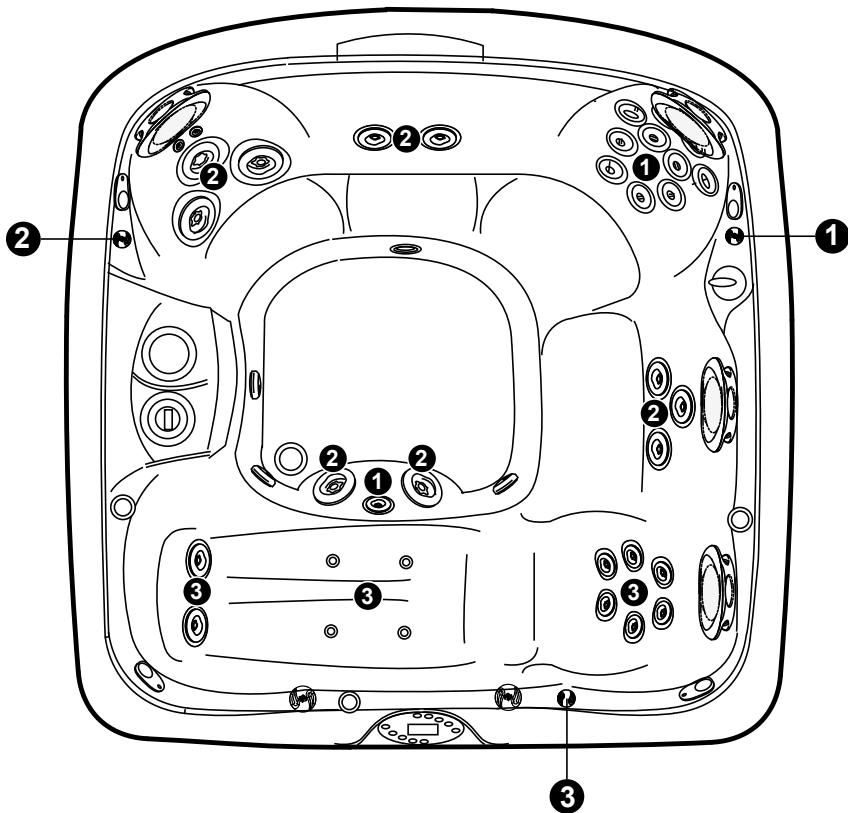

*Spa operation subject to change without notice.*

### **Air Controls Operation**

- Rotate air controls 1-3 to add air to designated jet groups.



## 9.19 J-460 Massage / Waterfall Selector Diagram

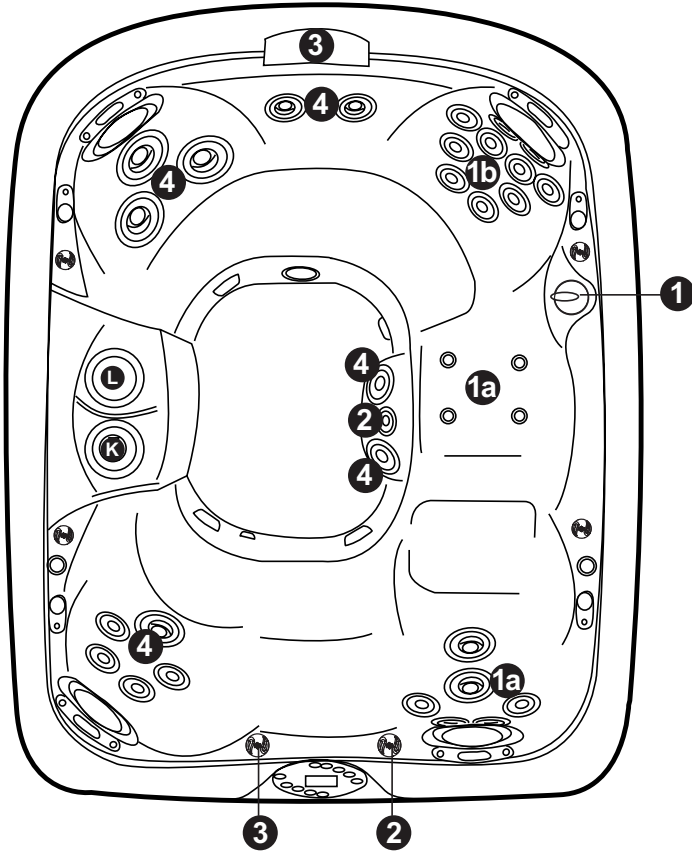

*Spa operation subject to change without notice.*

### **Massage Selector (1)**

- Massage selector 1 diverts pump 1 output between jets groups 1a-1b.

### **Massage Selector (2)**

- Massage selector 2 controls pump 1 output to footwell IX Jet.

### **Waterfall Selector (3)**

- Waterfall selector 3 controls circulation pump output to waterfall.

### **Jets Without Massage Selector Controls (4)**

- Jets 4 are always on when jets pump 2 is running.

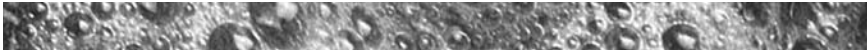

## 9.20 J-460 Air Controls Diagram

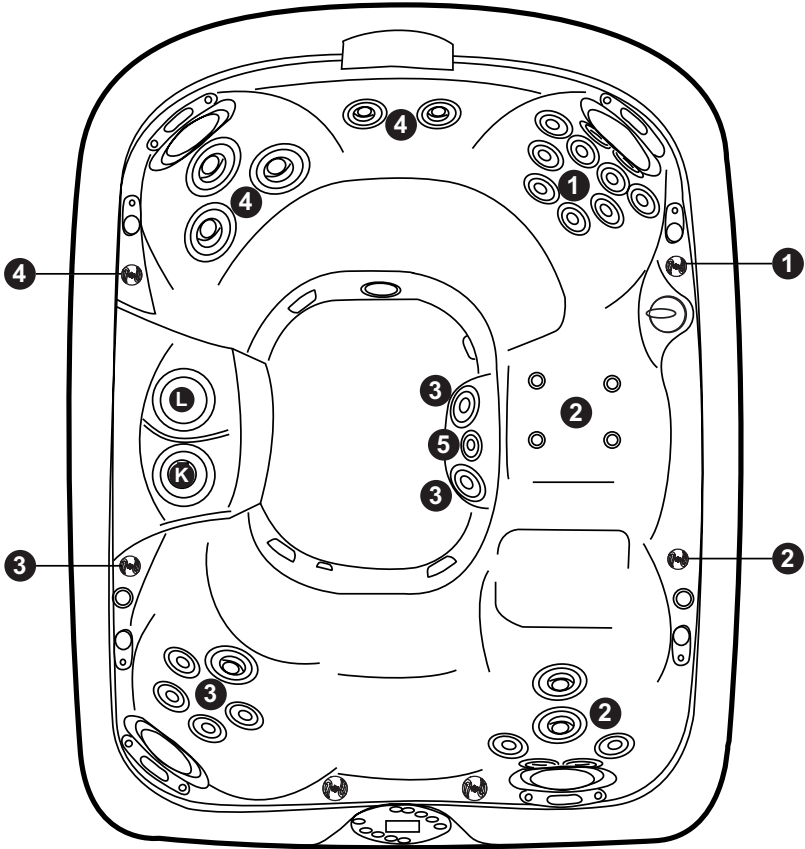

*Spa operation subject to change without notice.*

### **Air Controls Operation**

- Rotate air controls 1-4 to add air to designated jet groups.
- Center footwell IX Jet (5) draws air at all times when jets pump 1 is running. This jet has no air control.



## 10.0 Heating Modes

The control system in your spa activates a programmable “standard” or “economy” mode which effects when the heater operates. *Refer to sections 10.1 and 10.2 below for additional information.*

### 10.1 Standard Mode (Factory Default)

Standard mode is typically selected by customers in cold climates where heat up times are extended due to lower ambient temperatures. In this mode, water temperature is regulated by the set temperature which activates the heater automatically as needed.

### 10.2 Economy Mode

Economy mode is typically selected by customers in warm climates where heat up times are minimized due to higher ambient temperatures. In this mode, the water temperature is regulated by the set temperature only when a programmed filter cycle is running, unless in summer logic (page 38).

### 10.3 Selecting Standard or Economy Mode

Press the **MODE**  button to select either “Standard” or “Economy” mode. The control panel’s indicator on the right side of the LCD changes to indicate which mode is selected.

### 10.4 Clean-Up “Blow-Out” Cycle

The clean-up cycle is once per day in both Standard and Economy modes at 12:00 (noon) for two minutes. This is not user programmable. Jets pump 2 activates for one minute to circulate any water in the plumbing. After 1 minute, jets pump 2 shuts off and jets pump 1 turns on, runs for 1 minute, then shuts off.















## 11.0 Programming Instructions

### 11.1 Programming Filter/Circulation Pump Run Time

The Sentry control system allows you to easily adjust two separate aspects of filter/circulation pump operation:

1. The time of day (start time) the filter/circulation pump turns on.
2. The length of time (duration) the filter/circulation pump operates.

The factory default start time is 12:00AM (Midnight). The default duration is 24-hours. To make adjustments, press the **CYCLE**  button five times to enter the filter/circulation pump programming mode. The LCD screen display “**Circ**”. At this time the system is ready to accept your changes:

- Press the **SELECT**  button once. The previously programmed start time appears on the LCD display.
- Press **WARMER**  or **COOLER**  buttons to adjust the start time in 30-minute increments. 
- Press the **SELECT**  buttons to program duration.
- Press **WARMER**  or **COOLER**  buttons to program the duration time in 1 hour increments. 
- Press **DISPLAY**  button to save changes and recall the main water temperature display. Note: If no button is pressed within 30 seconds, all changes are recorded and the screen automatically returns to the standard water temperature display.

Note: when the standard mode is selected (sec. 10.3, page 36), the filter/circulation pump automatically turns on for a heat call regardless of the pump's programmed start time and duration.

### 11.2 Programming Filter Cycles

Your spa comes with four 30-minute filter cycles which activate the filter/circulation pump. These cycles are factory programmed to start at 6:00 am, 12:00 (noon), 6:00 p.m., and 12:00 (Midnight). The control system allows you to easily adjust two separate aspects of each cycle: 1) the time of day at which it begins; 2) the duration of the cycle.

*Note: When “Standard” mode is selected (sec. 10.3, page 36) and the filter/circulation pump is set to the factory default duration of 24-hours (sec. 11.1), each cycle is displayed on the main control panel, when*



running, but no apparent change of operation will occur. However, when “Economy” mode is selected (sec. 10.3, page 36), the heater activates only during a programmed filter cycle.

When in a Summer Logic condition is active (see note below), the filter/circulation pump will turn on for all programmed filter cycles.









**Summer Logic:** In warm weather, the water temperature in the spa may exceed the set temperature. This condition may occur due to heat transference from the filter/circulation pump and jets pumps. If the water temperature is higher than 95°F (35°C) and rises two degrees above the set temperature, a “Summer Logic” condition occurs that deactivates the filter/circulation pump and optional ozonator (if equipped). This safety feature cannot be altered! The filter/circulation pump and ozonator will remain off until the water temperature cools to the set temperature (except between 12AM-2AM when the filter/circulation pump runs for its mandatory 2-hour cycle). To help prevent a “Summer Logic” condition, it may be necessary to reduce filter/circulation pump cycles run times in warm weather.

To make adjustments, first press the **CYCLE**  button to enter the filter cycle programming mode. The LCD screen will display the following in the upper right corner:



\*Note: Number will vary according to which filter cycle is being programmed.

This means the system is ready to accept your changes to the start time for cycle number one. Simultaneously, the large four-digit display in the center of the screen displays the currently programmed start time for that cycle. At this point, you have four options. You may:

1. Press **WARMER**  or **COOLER**  button to adjust the start time in increments of 30 minutes.
2. Press **CYCLE**  button to display and adjust each subsequent cycles start time. With each press, the currently programmed status will be shown in the large four digit display. To adjust any displayed value, simply press the **WARMER**  or **COOLER**  button.
3. Press **SELECT**  button to move down the menu from Start Time to Duration, with each press, the currently programmed duration will be shown in the large four-digit display. Press **WARMER**  or **COOLER**  button to adjust the duration in increments of 15 minutes.





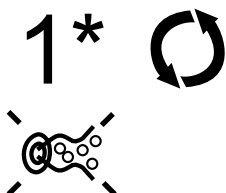

4. Press **DISPLAY**  button to save changes and recall the main water temperature display. Note: If no button is pressed within 30 seconds, all changes are recorded and the screen automatically returns to the standard water temperature display.









When a programmed filter/heating cycle activates, the LCD screen displays the following message:



\*Note: Number will vary according to which filter cycle is being programmed.

At any time, you may check the programming of any aspect of any filter/heating cycle by first pressing **CYCLE**  button then moving through the menu by pressing either **CYCLE**  or **SELECT**  button. The programming is changed only by pressing **WARMER**  or **COOLER**  buttons during this process.



### 11.3 Adjusting Time of Day

The Sentry control system remembers the time of day even in the event of a prolonged power outage. However, it may occasionally be necessary to reset the time of day. For example: if you are not in the Pacific Time Zone you will want to reset the time for your own time zone. (The system will automatically adjust to and from daylight savings time.) To accomplish this, press **DISPLAY** , **MODE**  and **DISPLAY**  buttons within five seconds each. A number representing the hour will be displayed, followed by AM or PM. The hour will advance or decrease each time **WARMER**  or **COOLER**  button is pressed within five seconds. Then, press **DISPLAY**  button again to display the minutes. Adjust the minutes as necessary by pressing **WARMER**  or **COOLER**  button. After 5 seconds, the display will return to normal and save your settings.



### 11.4 Main Control Panel Lock

To help prevent unauthorized use of your spa, the Sentry controls incorporate a unique panel locking system which disables the controls on the panel.



- To Lock The Main Control Panel: Press **DISPLAY** , **MODE** , and **WARMER**  buttons within five seconds each. A padlock symbol will appear on the LCD screen. With the panel locked, none of the components can be turned on and the only settings that can be adjusted are the standard and economy filter/heating mode and time of day. All automatic spa functions will operate normally.







- To Unlock Main Control Panel: Press **DISPLAY** , **MODE** , and **COOLER**  buttons within five seconds. The “lock” symbol will disappear. All buttons are now active.





### 11.5 Locking Filter Cycles

You may keep all filter cycle programs from being inadvertently altered by electronically “locking” them.

- To Lock All Filter Cycles: Press **CYCLE** , then within 30 seconds, press **DISPLAY** , **MODE**  and **WARMER**  buttons within five seconds each. A padlock symbol will appear on the screen. In this state, the status of the cycle program may be checked, but may not be altered.







- To Unlock Filter Cycles: Press **DISPLAY** , **MODE**  and **COOLER**  buttons within five seconds each.







### 11.6 Temperature Setting Lock

The spa's temperature setting can be locked to prevent unauthorized use. When locked, all other spa buttons and functions remain undisturbed.

- To Lock Temperature Setting: Press **WARMER**  or **COOLER**  button to display temperature setting, then immediately press the **DISPLAY** , **MODE** , and **WARMER**  buttons within five seconds each. A padlock symbol will appear on the screen.



- To Unlock Temperature Setting: Press **WARMER**  or **COOLER**  button to display temperature setting, then immediately press the **DISPLAY** , **MODE** , and **COOLER**  buttons within five seconds each.









## 11.7 Programming The Change Filter Reminder

Your new spa is equipped with a programmable “Change Filter” reminder icon that flashes on the control panel display after a specified number of days. It is designed to remind you to clean the skimmer filter cartridge on a regular basis but does not affect spa operation in any way. The “Change Filter” reminder must be reset at each filter cleaning interval. It offers a selectable range from 10-120 days or can be disabled (turned off). We recommend an initial setting of 60 days (2 months) to remind you to check your filters after your first 2 months of operation. At this time, you can easily determine whether you need to change this interval by visually inspecting the filter cartridge and polishing bag. *Note: this reminder must be reset at each filter cleaning interval. Refer to section 12.1 below for filter cleaning instructions.*



### Programming Instructions

1. Press the **CYCLE**  button 6 times. The main display reads “FIL” indicating the “Change Filter” display program has been accessed.
2. Press **SELECT**  button once to display the currently programmed duration or to view days elapsed since last filter cleaning interval.
3. Press **WARMER**  or **COOLER**  button to change duration setting as follows:  
0 - 10 - 20 - 30 - 40 - 50 - 60 - 70 - 80 - 90 - 100 - 110 - 120 - OFF
4. Press **DISPLAY**  button once to save changes and return to the standard water temperature display. *Note: If no button is pressed within 30 seconds, all changes are recorded and the screen automatically returns to the standard water temperature display.*

## 12.0 Spa Maintenance

Proper and regular maintenance of your spa will help it retain its beauty and performance. Your authorized Jacuzzi dealer can supply you with all the information, supplies, and accessory products you will need to accomplish this.

### 12.1 Cleaning The Filter Cartridges

A programmable “Change Filter” reminder icon flashes on the control panel display after a specified number days to remind you to clean the skimmer filter and to check the polishing bag filter. This reminder must be reset at each filter cleaning interval. Refer to section 11.7 (above) for additional information and programming details. Your new spa is equipped with an advanced 2-stage filtration system. Fine debris are filtered by the circulation pump drawing water through the ProClear™ skimmer and pleated filter





cartridge 24-hours (unless programmed otherwise). Large debris are filtered when either jets pump is running when the spa is in use or during a programmed filter cycle. These pumps draw water from footwell suction fitting and through a secondary water polishing bag filter. The exclusive footwell “sweeper” suction fitting enhances filtration in the footwell area by creating a “swirling” water motion to maximize particle agitation and pickup.

To ensure optimum performance, the 24-hour ProClear™ skimming filter cartridge (A) must be cleaned every three months and replaced once a year and the secondary ProClear™ Plus polishing filter bag (B) should be emptied weekly and replaced every 3 months. *To accomplish this, refer to the following filter cleaning procedure. Note: Do not attempt to wash the polishing filter bag (B) or it will come apart!*

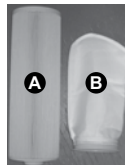

**ALWAYS TURN POWER TO THE SPA OFF BEFORE CLEANING THE FILTER CARTRIDGES! NEVER OPERATE SPA WITHOUT FILTER LID (2) AND SKIMMER ASSEMBLY (4) INSTALLED.**

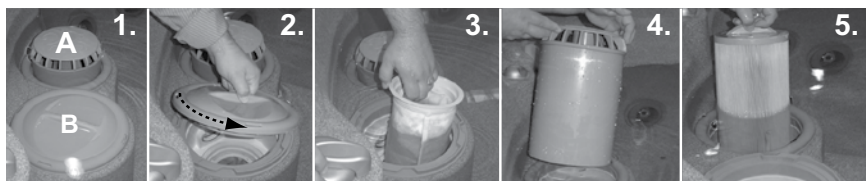

1. Remove power to the hot tub before removing the skimmer (A) or filter bag cover (B).
2. Remove the polishing bag lid (B) by rotating it counterclockwise approximately 5 degrees until you feel it unlatch.
3. Remove the polishing bag by reaching into the filter bucket and gently pulling upward on the blue filter ring (empty filter bag weekly or install a new bag every three months.) Replace bag, then install filter lid by rotating it clockwise until you feel it latch in place. **DO NOT FORCE LID! FINGER TIGHT ONLY!**
4. Remove the ProClear skimmer assembly (A) by gently lifting upward from the filter bucket.
5. Remove the ProClear filter cartridge by rotating it counterclockwise to unthread it, then remove the center cap and chemical dispenser from the filter cartridge as shown (right).
6. Clean the ProClear filter cartridge (A) with a garden hose and high pressure nozzle. Rinse debris from the filter





pleats beginning at the top and working your way downward. Continue, one section at a time until you have cleaned all debris from the filter pleats. When replacing the filter cartridge, make sure you remove the center cap and chemical dispenser for use with the new cartridge. Replacement filter cartridges may be purchased from your authorized Jacuzzi dealer. Request #20086-001 for the main pleated cartridge (A) and #20076-001 for the secondary polishing filter bag (B).

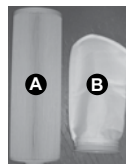

## 12.2 Draining and Refilling

About every 3 to 6 months, you will want to replace the spa's water. The frequency depends on a number of variables including the amount of use, number of users, attention paid to water quality maintenance, etc. You will know it is time for a change when you cannot control sudsing and/or you can no longer get the normal feel or sparkle to the water even though the key water balance measurements are all within the proper parameters.



**CAUTION! READ THIS BEFORE DRAINING:** To prevent damage to the spas components, turn off power to the spa at the circuit breaker before draining it. Do not turn the power back on until your spa has been refilled.



**CAUTION:** There are certain precautions to keep in mind when draining your spa. If it is extremely cold, and the spa is outdoors, freezing could occur in the lines or the equipment (see "WINTERIZING", page 45). On the other hand, if it is hot outdoors, do not leave the spa's surface exposed to direct sunlight.

To drain your spa, perform the following steps:

1. Turn off power to spa at breaker.
2. Locate the drain valve located on the front left corner on the black plastic pan. Hold the larger (rear) drain valve body to prevent it from turning, then loosen and remove the front cap to expose the underlying male hose threads.
3. Attach a garden hose to the exposed threads.

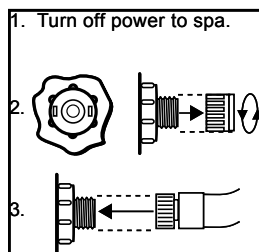



4. Gently rotate the larger (rear) valve body 1/3 turn counterclockwise to unlock the drain valve.
5. Pull the larger (rear) body outward as shown to open drain.
6. After the spa drains, perform steps 2-5 in reverse order to close the drain prior to refilling spa.

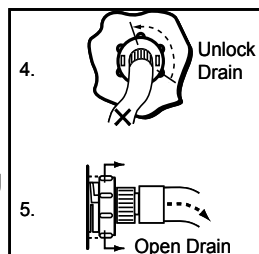

After refilling, turn on power to the spa and follow the steps listed under “Spa Fill Up Procedures.” (page 14). Always fill your spa through both filter buckets.

### 12.3 Cleaning The Spa Interior

To preserve the sheen of your spa’s surface, it is crucial that you avoid using abrasive cleaners or cleaners which have adverse chemical effect on the surface. If you are not certain as to the suitability of a particular cleanser, consult your authorized Jacuzzi dealer. Regardless of the cleanser used, use extreme care to assure that no soap residue is left on the surface. This could cause severe sudsing when the spa is refilled.

### 12.4 Pillow Care

Clean the four headrests in your spa as needed by wiping them with a clean cloth or soft brush saturated with detergent soap. It is not necessary to remove the headrests for cleaning.

To remove headrests for long term storage or replacement, grasp both ends of each headrest and gently pull inward towards the center of the spa. To reinstall, over mounting strip and press down until headrest mounting bracket emits a “click” sound. Then adjust headrest height by simply moving up or down as desired.

### 12.5 Maintaining The Synthetic Cabinet

The synthetic cabinet requires little or no maintenance of any kind. To clean, simply wipe cabinet with a clean towel and mild detergent soap solution.





**CAUTION:** Never spray cabinet with a high pressure garden hose for any reason since this action may induce an electrical short in the spa's electrical equipment.

## 12.6 Maintaining The Cover

Using the Jacuzzi insulating spa cover anytime the spa is not in use will significantly reduce your operating costs, heat-up time, and maintenance requirements. To prolong the life of the cover, handle it with care and clean it regularly using mild soap and water. Periodic treatments with a special conditioner developed for Jacuzzi spa covers will help protect against deterioration caused by U.V. rays from the sun. Never allow anyone to stand or sit on the cover, and avoid dragging it across rough surfaces.

## 12.7 Winterizing

Your Jacuzzi spa is designed to automatically protect itself against freezing when operating properly. During periods of severe freezing temperatures, you should check periodically to be certain that the electrical supply to the spa has not been interrupted. In extreme, bitter cold weather (less than -20°F) verify the filter/circulation pump is set for 24-hour operation (sec. 11.1, page 37) and that standard mode is selected (sec. 10.3 page 36) to protect the spa from freezing.

If you do not intend to use your spa, or if there is a prolonged power outage during periods of severe freezing temperatures, it is important that all water be removed from the spa and equipment to protect against damage from freezing.

For expert winterization of your spa, contact your authorized Jacuzzi dealer. In emergency situations, damage can be minimized by taking the following steps:



**CAUTION:** Turn off power to spa.

1. Follow the directions on page 43-44 for draining the spa.



2. As the water level drops below the seats, use whatever means necessary to get the water out of the recessed seating areas and into the footwell.
3. When the water level ceases to drop, use whatever means available to remove any remaining water from the footwell.
4. Remove the equipment-side cabinet panels and locate the drain plugs in the front of each pump (Figure-A, page 11). Remove these plugs to allow the water to drain out of the pumps and heater. (Note: Approximately one to two gallons will be released during this procedure. Use a wet/dry vacuum or other means to keep this from flooding the equipment compartment. Replace the drain plugs.
5. Loosen hose clamp at bottom of heater (Figure-A, page 11) and pull hose off of heater fitting (twist the hose back and forth while pulling downward). Tip hose down and allow to drain, then reinstall hose and clamp.
6. Re-install cabinet side panels and cover spa so that no casual moisture can enter into it.

Consult your Jacuzzi dealer if you have any questions regarding winter use or winterizing.

## **12.8 Restarting Your Spa in Cold Weather**

If you want to start up your spa after it has sat empty for a time in freezing temperatures, be aware that the water remaining in certain sections of the piping may still be frozen. This situation will block water flow preventing the spa from operating properly and possibly damaging the equipment. We recommend you consult your dealer for guidance before attempting to restart your spa under these conditions.

## **13.0 Water Quality Maintenance**

Maintaining the quality of the water within specified limits will serve to enhance your enjoyment and prolong the life of the spa's equipment. It is a fairly simple task, but it requires regular attention because the water chemistry involved is a balance of several factors. There is no simple formula, and there is no avoiding it. Procrastination in regard to water maintenance will result in poor and potentially unhealthful conditions for soaking and even damage to your spa investment. For specific guidance on maintaining water quality, consult your Authorized Jacuzzi dealer who can recommend appropriate chemical products for sanitizing and maintaining your spa.



**CAUTION:** Never store spa chemicals inside the spa's equipment bay.

### 13.1 pH Control

pH is a measure of relative acidity or alkalinity of water and is measured on a scale of 0 to 14. The midpoint of 7 is said to be neutral, above which is alkaline and below which is acidic. In spa water, IT IS VERY IMPORTANT TO MAINTAIN A SLIGHTLY ALKALINE CONDITION OF 7.4 to 7.6. Problems become proportionately severe the further outside of this range the water gets. A low pH will be corrosive to metals in the spa equipment. A high pH will cause minerals to deposit on the interior surface (scaling). In addition, the ability of the sanitation agents to keep the spa clean is severely affected as the pH moves beyond the ideal range. That is why almost all spa water test kits contain a measure for pH as well as sanitizer.

### 13.2 Sanitizing

To destroy bacteria and organic compounds in the spa water, a sanitizer must be used regularly. Your Jacuzzi spa is equipped with the Brominator™, a special compartment built into the floating skimmer gate to hold Bromine tablets. By regulating the number of Bromine tablets in the Brominator™ you can control the amount of Bromine which is actively working in your spa water. A Bromine residual of 2.0-4.0 ppm is generally considered desirable. A two-part Bromine system or granular Chlorine (Dichlor) are also acceptable sanitizers.



**IMPORTANT:** Do not use Chlorine tablets (Trichlor) in your spa. This chemical can have an extremely corrosive effect on certain materials in the spa. Damage caused by use of this chemical, or improper use of any chemicals, is not covered under the spa's warranty.

### 13.3 Other Additives

Many other additives are available for your spa. Some are necessary to compensate for out-of-balance water, some aid in cosmetic water treatment and others simply alter the feel or smell of the water. Your Authorized Jacuzzi dealer can advise you on the use of these additives.



### 13.4 Optional Ozone Water Maintenance System

If you have elected to have your spa equipped with the optional Jacuzzi CD Ozone water purification system you will find that your water stays fresh and clear with significantly less chemical sanitizer usage. You will also probably be able to go longer between complete spa draining.

## 14.0 Troubleshooting - Display Messages

There are a number of unique functions designed into your Jacuzzi spa to protect it from damage and/or to aid in troubleshooting. Following is a listing of all the possible messages along with their meanings:

#### MESSAGE

**OH**

#### MEANING

Overheat Protection (Heater is deactivated, filter/circulation pump is activated). Water temperature is above acceptable limits. Do not enter the water! Remove spa cover to speed cooling. See "Water Is Too Hot" on page 52. If condition persists, contact your dealer or authorized service center.

**COOL**

If the spa water is more than 20°F cooler than the temperature set point, jets pump #1 and heater will automatically activate to provide freeze protection. The spa will stay in this mode until the water temperature reaches 15 degrees below the set temperature. No corrective action is necessary.

**FLO**

FLOW SWITCH (Heater is deactivated. The filter/circulation may also be deactivated). Proper flow of water is inhibited or a flow switch has malfunctioned. Check for proper water level and for clogged filter (page 41-42). Contact your dealer or service organization.

\*NOTE: THIS MESSAGE CAN ALSO APPEAR IF THE PUMP HAS NOT REGAINED PRIME AFTER THE SPA HAS BEEN DRAINED AND REFILLED. IF YOU SUSPECT THAT THIS IS THE CASE, SEE THE INSTRUCTIONS ON PAGE 51 UNDER "PUMP DOES NOT OPERATE BUT ICON DOES"



**Hold**

Panel buttons have been pressed too many times in a short period of time. Because this could cause excessive wear on equipment components, panel buttons are temporarily deactivated. Panel buttons will automatically re-activate if no button is pressed for 30 seconds.

**HOT**

Circuit board temperature has exceeded acceptable limit. This message will disappear when the circuit board temperature drops below acceptable limit. If condition persists, provide shade for equipment side of spa.

**ICE**

**FREEZE PROTECTION**

A potential freeze condition has been detected. No action is required. Jets pump(s) operate until the spa is out of danger. Note: This error commonly occurs when the spa is first filled because tap water is often very cold.

**PnL**

Communication between the control panel and/or remote control panel and circuit board is faulty. Contact your dealer or service organization.

**----**

“WATCHDOG” (spa is deactivated)

A problem has been detected which could cause damage to the spa or its components. Contact your dealer or service organization.

**Sn1**

OPEN SENSOR (heater disabled) OR SHORTED SENSOR (spa is deactivated) The high-limit temperature sensor is non-functional. This must be repaired only by a dealer or qualified service organization.

**Sn3**

OPEN OR SHORTED SENSOR (heater disabled) The main sensor is non-functional. This must be repaired only by a dealer or qualified service organization.



**FLO2**  
**1CE2**

CLOSED OR SHORTED FLOW SWITCH ON SYSTEM STARTUP (system disabled) Flow switch is non-functional. This must be repaired only by an authorized dealer or qualified service organization.



## 15.0 Troubleshooting - Procedures

In the unlikely event your spa is not working the way you believe it should, please first review all the installation and operating instructions in this manual and check the message on the panel display; second, if you are still not satisfied it is working properly, please follow the appropriate troubleshooting instructions.

| <b>PROBLEM</b>                                   | <b>PROCEDURE</b>   |
|--|--|
| NONE OF THE COMPONENTS OPERATE (i.e. pump light) | Check the control panel lights.<br>1. If there are letters or symbols displayed on the screen, refer to the previous section to determine the meaning and action required.<br>2. If nothing appears on the screen:<br>A. Check the household circuit breaker<br>B. Contact you dealer or authorized service center                                 |
| PUMP DOES NOT OPERATE AND ICON DOES              | Depress "JETS" button.<br>1. If no sound is detected or if a "buzzing" sound AND ICON DOES is detected, turn off power to the spa and contact your dealer or service center.<br>2. If motor operates but no water flows to jets:<br>A. Pump may not be properly primed. See instructions below.<br>B. Contact dealer or authorized service center. |

### Pump Priming Instructions:

1. Turn off power to the spa.
2. Remove the handle from the massage selector supplied by the pump you are priming.
3. Loosen the massage selector's cap slightly (counterclockwise), listening for the air to seep out.
4. Tighten the cap finger-tight, replace the handle and turn the hot tub's power back on.



Note: This method must be used for the jets pumps because these pumps are not connected to the main filter system in any way.

**IMPORTANT:** If freezing conditions exist and pump is not operational, take measures to protect the system from freeze damage. See section titled “Winterizing” (page 45).

POOR JET ACTION  
(see page 28-35)

1. Make certain the jets pump is turned on.
2. Check position of massage selectors.
3. Open air control for selected jet system.
4. Check for adequate water level.
5. Check for dirty filter (page 41-43).

WATER IS TOO HOT

1. Reduce thermostat setting (page 15).
2. Switch hot tub to “Economy” mode to turn heater on only during programmed filter cycles (page 36).

NO HEAT

1. Check thermostat setting.
2. Keep the cover in place while heating.
3. If “heater on” indicator is lit (page 19), but no temperature rise is experienced after a reasonable period of time, contact your dealer or authorized service center.

FILTER/CIRCULATION  
PUMP OFF

1. Verify filter/circulation pump is programmed to run 24-hours a day (page 37).
2. Filter/circulation pump cycle canceled by power interruption. Wait 24-hours for hot tub to reset.
3. Hot tub water is warmer than 95°F (35°C) and two degrees warmer than the set temperature. The “Summer Logic” safety feature has activated. See note on page 38 for details.





# 16.0 US/Canada 60Hz J-460/J-465/J-470/J-480 Wiring Diagram

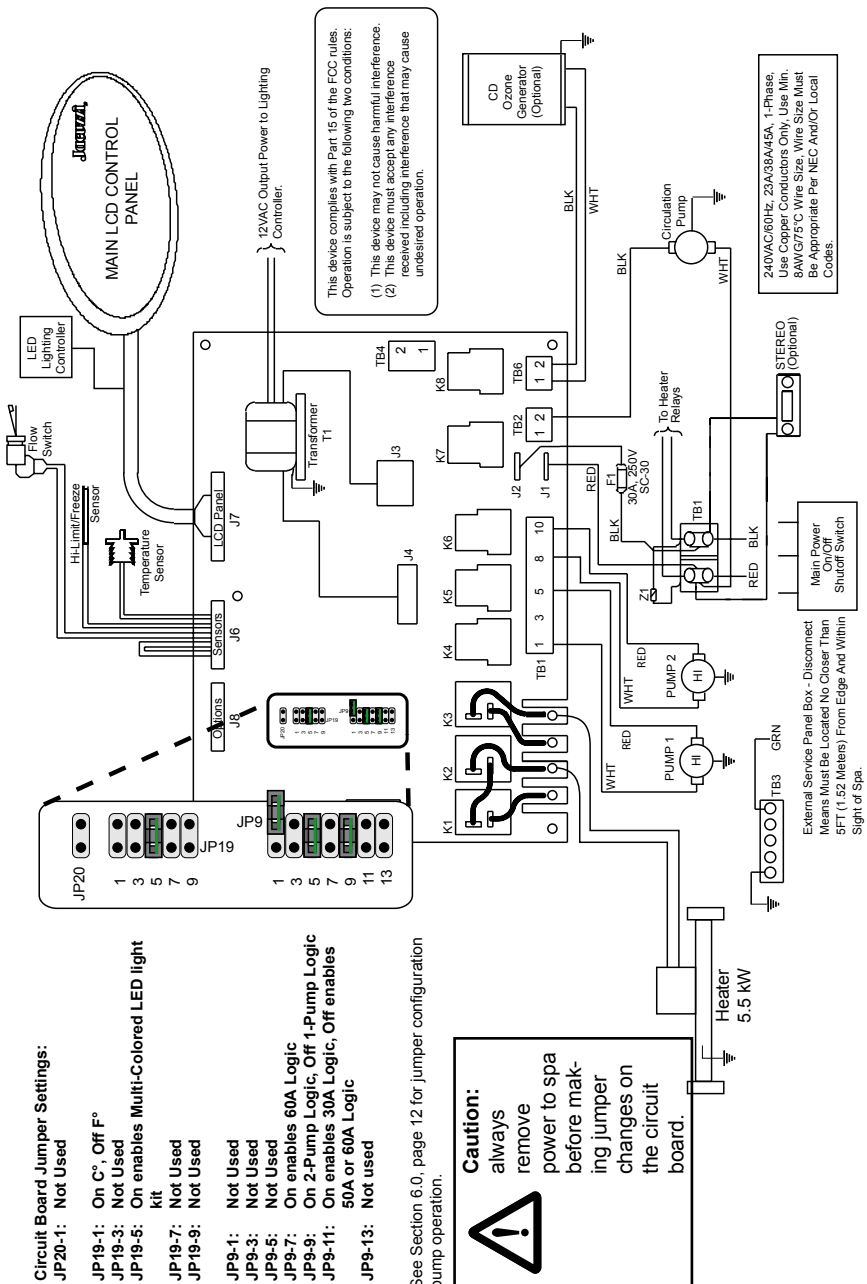

# 17.0 Export 50Hz J-460/J-465/J-470/J-480 Wiring Diagram

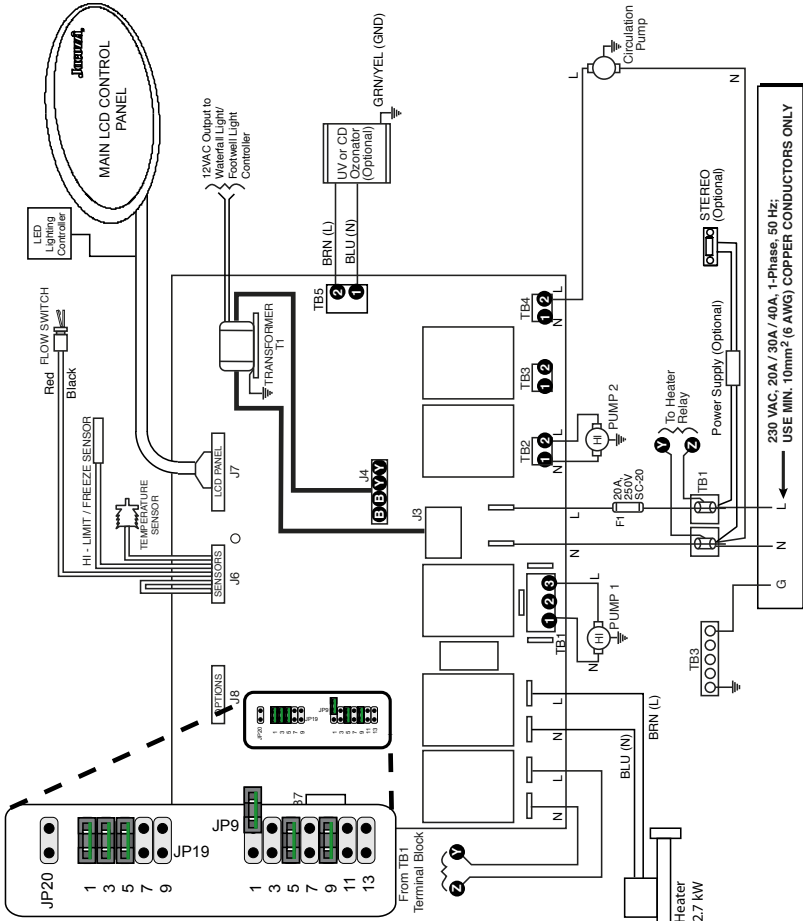

**Circuit Board Jumper Settings:**

|         |  |
|---------|--|
| JP20-1: | Not Used   |
| JP19-1: | On C', Off F <sup>s</sup>                          |
| JP19-3: | On 50Hz, Off 60Hz                                  |
| JP19-5: | On enables Multi-Colored LED light kit             |
| JP19-7: | Not Used   |
| JP19-9: | Not Used   |
| JP9-1:  | Not Used   |
| JP9-3:  | Not Used   |
| JP9-5:  | Not Used   |
| JP9-7:  | On enables 40A Logic                               |
| JP9-9:  | On 2-Pump Logic, Off 1-Pump Logic                  |
| JP9-11: | On enables 20A Logic, Off enables 30A or 40A Logic |
| JP9-13: | Not Used   |

See Section 6.0, page 12 for jumper configuration pump operation.

**Caution:**

always remove power to spa before making jumper changes on the circuit board.

## 18.0 Typical Spa Wiring Diagrams A-B (US/Canada 60Hz Models Only)

### A 2-Pole Circuit Breaker with 2-Wire Grounded Load Connection (3 Wires to Hot Tub, 2-Hot (L1-L2), 1-Ground)

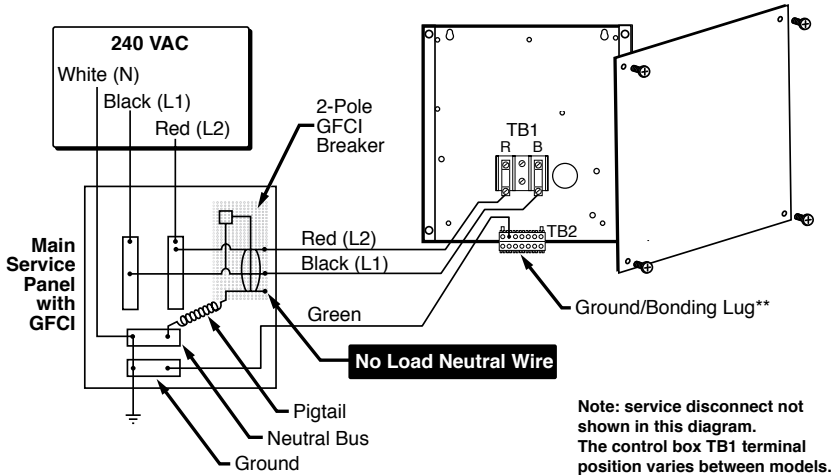

### B Main Panel with Secondary GFCI Shut-Off Box Using a 2-Pole GFCI Breaker with 2-Wire Grounded Connection (3 Wires to Hot Tub, 2-Hot (L1-L2), 1-Ground)

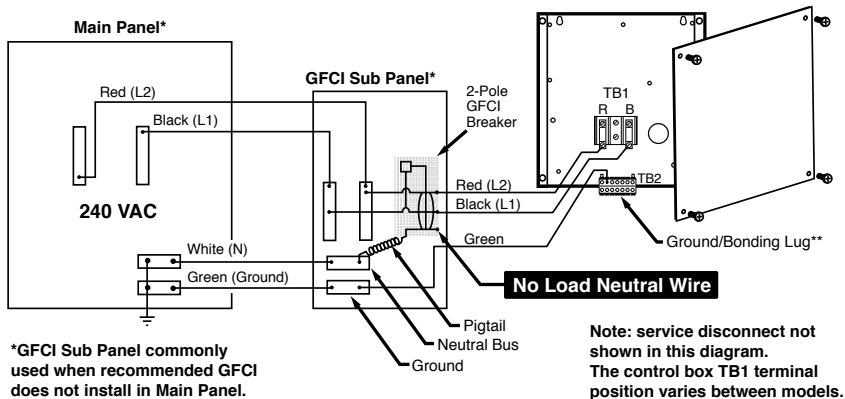



Jacuzzi builds the best spas in the industry. Nonetheless, we are always striving to improve the quality and features of our products. Your input as a Jacuzzi spa owner is a cherished part of this process. If you have any comments or suggestions, or if you wish to be informed on any new products for your spa, please write to us.

**CONGRATULATIONS** on your good taste and welcome to the happiest and most relaxed family in the world!



## 19.0 Optional Jacuzzi Stereo Receiver Features

### 19.1 General Controls

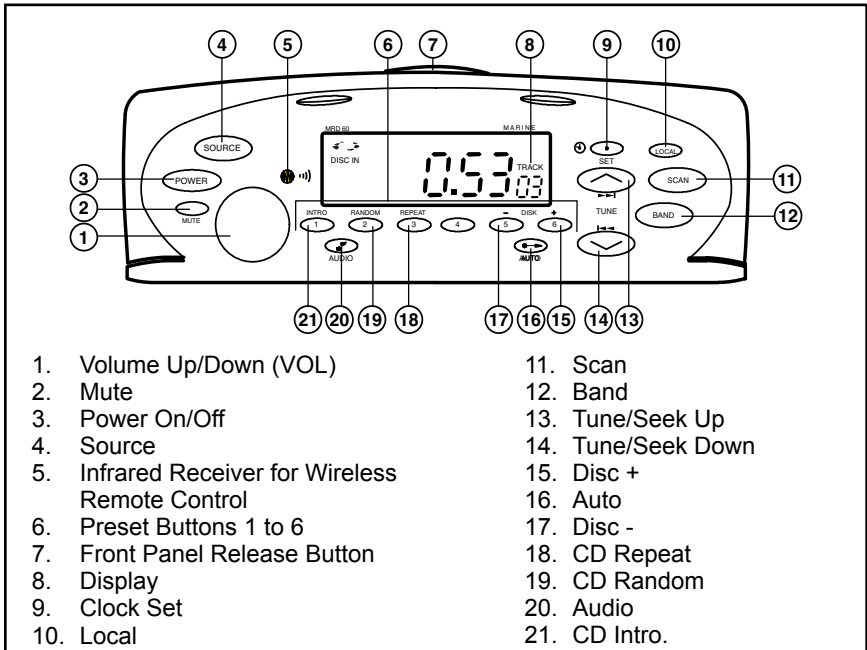

#### A. Power On and Off

Make sure spa power is turned on, then press power button (3) once to turn on. Press a second time to turn off.

#### B. Adjusting Volume

Rotate volume knob (1) to increase or decrease volume. Current volume setting is briefly indicated on the display (0 to 31).

#### C. Mute

Press mute button (2) once to mute audio output ("Mute" flashes on display). To restore audio output, press mute button a second time, or rotate volume knob.

#### D. Program Selection

Press source button (4) to cycle through available program sources as follows: Tuner - CD - AU- Tuner. If a source is unavailable (e.g. no CD or MP3 Player inserted), that source will not appear on the display.



### **E. Adjusting Bass Level**

Press audio button (20) until display reads “BAS.” Rotate volume knob to desired setting. A display of “C O” indicates center, -2 to -12 indicates bass cut, and +2 to +12 indicates bass boost. Note: unit returns to volume mode if volume control is not rotated for 3 seconds.

### **F. Adjusting Treble Level**

Press audio button (20) until display reads “TRE.” Rotate volume knob to desired setting. A display of “C O” indicates center, -2 to -12 indicates treble cut, +2 to +12 indicates treble boost. Note: unit returns to volume mode if volume control is not rotated for 3 seconds.

### **G. Adjusting Balance**

Press the audio button (20) until display indicates “BAL.” Rotate volume knob to desired setting. A display of “C O” indicates center, L1 to 15 indicates left balance, R1 to 15 indicates right balance. Note: unit returns to volume mode if volume control is not rotated for 3 seconds.

## **19.2 Radio Operation**

### **A. Adjust Fader**

Press audio button (20) until display reads “FAD.” Rotate volume knob to desired setting. A display of “C O” indicates center, “R” 1 to 15 indicates rear fade, “F” 1 to 15 indicates front fade. Note: unit returns to volume mode if volume control is not rotated for 3 seconds.

### **B. Display Clock**

Press set button (9) to toggle display between clock and radio modes. When clock mode is selected, the current time displays whenever the unit is left undisturbed.

### **C. Set Clock**

Press and hold set button (9) for 2 seconds until first time digit flashes on display. Use tune/seek-up button (13) or tune/seek-down button (14) to set hour, noting AM/PM indicator at left. Briefly press set button a second time to select minutes display. Press set button a third time to complete procedure. Unit remains in clock mode and displays time after 3 seconds. Note: When power to spa is shut off for any reason, the clock will be reset to 12:00 AM.



#### **D. Open/Close Front Panel**

Place thumb on front panel release button (7) with forefinger below front overhang. Press firmly on release button, then flip panel open by pulling outward at top edge. To close panel, flip panel up and press firmly until you hear an audible click. Keep the front panel closed at all times to prevent water intrusion, except when changing discs. CAUTION: never insert wet discs into unit or CD player will be damaged!

#### **E. Radio Operation**

Press source button (4) to select radio mode. Station frequency is indicated on display.

- To Select Band: press band button (12) to toggle through radio modes as follows: FM1 - FM2 - FM3 - AM1 - AM2 - FM1. Each radio band stores up to 6 independent presets, for a total of 18 FM and 12 AM presets.
- To Program Presets: tune in desired radio station, then press and hold desired preset button for at least 2 seconds. "PX", where X=preset number, appears at bottom right of the display. Note: When power to spa is shut off for any reason, all station presets are reset.

#### **F. Automatically Setting Station Presets**

To automatically set station presets to their next higher stations, press the preset button (1 to 6) from which to start programming, then press and hold the auto button (16) for 3 seconds. The current station preset and additional preset memories up to P6 will be reprogrammed with their next higher tunable stations. When the auto preset cycle is complete, the unit will remain in preset scan mode and continue scanning for presets until the auto button (16) is pressed. To select only the strongest stations, press the local button (10). All 18 FM and 12 AM presets can be set sequentially by selecting the next band and continuing the operation during auto programming.

#### **G. Seek / Manual Tune**

Press tune/seek-up button (13) once to automatically tune the next higher station. Press tune/seek-down button (14) once to automatically tune the next lower station. To manually tune to a specific station frequency, press and hold either tune/seek button for at least 2 seconds. Holding either button down will increase or decrease the displayed frequency manually. When the desired frequency is reached, release the button. The unit remains in manual tune mode for 3 seconds after



either button is released so you can fine tune the station frequency with additional button presses. Note: After 3 seconds, seek mode is re-enabled.

## H. Scan Functions

Select any AM or FM band and press scan button (11) to listen to a few seconds of each radio station. The display will flash and the radio will automatically scan to the next higher station, play that station for a few seconds, then scan to the next higher station. To stop scanning and continue listening to the current station, press scan button a second time. Note: the radio remains in scan mode until the scan button is pressed a second time or one of the tune buttons is pressed.

## I. Preset Scan Function

Press the auto button (16) once to enter scan mode. The next higher preset station will be selected and be played for 3 seconds while the preset number on the display flashes. If you wish to remain on this station, press the auto button (16) a second time. Note: preset scanning continues unless you press the auto button (16) or either preset button (P1-P6) to cancel.

## J. Local/Distance Function

Press the local button (10) to toggle between local and distant station mode. When "LOCAL" is displayed, only the strongest stations will be selected during seek or scan. Note: in the default mode (no LOCAL display), all usable stations will be selected during seek or scan.

## K. Changing Tuner Frequency from US to Europe

Your unit is factory set to US tuning frequency steps. To switch to Europe tuning steps, use the switch on the bottom of the unit. With the unit disconnected from the power source, use a screwdriver to slide the switch to the desired position. **Note: power must be removed from the radio, or the reset switch must be pressed before the new frequency mode is activated.**

## 19.3 CD Player Operation

### A. Insert, Play, and Eject a CD

Open the front panel and insert a CD into the slot with the CD label facing up. The CD will be drawn inside by the motorized mechanism. Close the front panel. The "DISC IN" symbol on the display indicates that a CD is in the drive.





- To play CD: press the source button (4) to change to CD mode. The CD will play. The display shows the current track and play time, and will animate a 3-D rotating disc while the CD is playing. Note: if CD play time is not shown, press clock set button (9) once.
- To remove CD: open the front panel and press the CD eject button located under the front panel. Remove CD from drive and close front panel. **CAUTION: listen for an audible click to ensure the front panel is closed to prevent water intrusion that could damage your unit.**

### **B. Changing CD Tracks and Music Seek**

To advance to the next track, press the tune/seek-up button (13) once and the track counter will increase one track. When the final track is reached on the CD, play will resume on track #1.

- To fast forward through tracks: press and hold the tune/seek-up button (13) until the track counter displays the desired track, then release the button.
- To return to the beginning of the current track: press the tune/seek-down button (14). Pressing it a second time within 1 second will skip back to the previous track.
- To rewind the current track: press and hold the tune/seek-down button (14). The track will quickly rewind until you release the button.

### **C. Intro Scan, Random, Repeat**

Intro Scan Mode: press intro button (21) to enter intro scan mode. The left side of the display reads “SCN” and the first 10 seconds of each CD track will play continuously until you press the intro button a second time, or press either tune/seek-up button (13) or tune/seek-down button (14).

- Random Mode: press the random button (19) to play the CD tracks in random order. The left side of the display reads “RDM” when random mode is enabled.
- Repeat Mode: press the repeat button (18) to repeat the current CD track continuously. The left side of the display reads “RPT” when repeat mode is enabled.



## 19.4 Specifications

### Tuner

|  |        |
|--|--------|
| FM usable sensitivity 10 dBf           |        |
| FM 50 dB quieting sensitivity .....    | 15 dBF |
| FM alternate channel selectivity ..... | 90 dB  |
| FM stereo separation @ 1kHz.....       | 60 dBf |
| AM usable sensitivity.....             | 30 UV  |

### CD Player

|   |           |
|---|-----------|
| Sampling frequency (8X oversampling)..... | 44.1 kHz  |
| Channel separation @ 1 kHz .....          | 80 db     |
| Signal-to-noise ratio.....                | 90 dBA    |
| Frequency-to-noise response @ ±1 dB.....  | 20-20 kHz |

### Audio

|   |                |
|---|----------------|
| Maximum power output (45 watts x 4 channel).....  | 180 W          |
| Continuous power, 20-20 kHz, 4 ohms, 1% THD ..... | 18 x 4         |
| Bass boost/cut.....                               | 10/100±dB/Hz   |
| Treble boost/cut.....                             | 10/10+/-dB/kHz |

### General

|                              |               |
|------------------------------|---------------|
| Nominal power supply .....   | 14.4 VDC      |
| Allowable power supply ..... | 10.8-15.6 VDC |
| Current consumption .....    | <10 Amp       |
| Speaker impedance.....       | 4-8 Ohms      |



**The following UL requirements must be observed for all spas with optional stereo components installed.**

- A. "Caution - Risk of Electric Shock. Do not leave compartment door open";
- B. "Caution - Risk of Electric Shock. Replace component only with identical components"; and
- C. Do not operate the audio/video controls while inside the spa."
- D. "Warning - Prevent Electrocutation. Do not connect any auxiliary components (for example: cable, additional speakers, headphones, additional audio/video components etc.) to the system."
- E. These units are not provided with an outdoor antennae; when provided, it should be installed in accordance with Article 810 of the National Electric Code, ANSI/NFPA 70.
- F. Do not service this product yourself as opening or removing covers may expose you to dangerous voltage or other risk of injury. Refer all servicing to qualified service personnel.
- G. When the power supply connections or power supply cord(s) are damage; if water is entering the audio/video compartment or any electrical equipment compartment area; if the protective shields or barriers are showing signs of deterioration; or if there are signs of other potential damage to the unit, turn off the unit and refer to a qualified service personnel.
- H. This unit should be subject to periodic routing maintenance (for example, once every 3 months) to make sure that the unit is operating properly.

P/N: 6530-509, Rev. A



## 19.5 iPod Docking Station

### A. Docking Your iPod

The Docking Station for iPod is compatible with all dockable Apple iPod models.

To install Apple iPod:

1. Locate and open Docking Station door by gently pulling outward on handle as shown (A).
2. Center the iPod over Docking Station Interface Port, then gently press downward as shown (B). DO NOT FORCE!
3. Close Docking Station door as shown (C), then refer to section below for stereo system iPod selection and operation details.

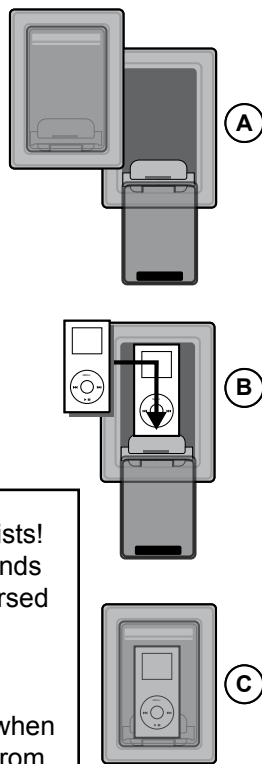

**WARNING:** Electrical Shock Hazard Exists!

- Never install or remove iPod while hands are wet or while sitting partially immersed or fully immersed in spa!



**CAUTIONS:**

- Never leave iPod in Docking Station when spa is not in use to prevent damage from outdoor elements!
- Never spray Docking Station with pressurized water hose for any reason! Damage to iPod or spa stereo system caused by water intrusion is not covered under the manufacturer warranty!
- Damage to Docking Station port or iPod due to excessive force or improper alignment during installation or removal from Docking Station is not covered under warranty.

### B. Setting Up The iPod for Use

1. Select and play preferred song/album/playlist prior to docking iPod.
2. Press "Source Button"  on stereo receiver or remote until the display reads "CD-1". SOURCE



### C. Use Wireless Remote or Stereo to Operate iPod

| Button          | Operation                            |
|-----------------|--------------------------------------|
| Press ►►        | Next Track                           |
| Press ►► & Hold | Fast Forward                         |
| Press ◀◀ x 2    | Return to Beginning of Current Track |
| Press ◀◀ x 3    | Recall Previous Tracks               |
| Press 4         | Pause (Press Again to resume Play)   |

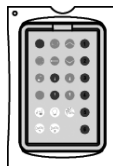

### 19.6 Generic MP3 Player Operation

#### A. Connecting Your MP3 Player

1. Plug in any MP3 Player's headphone output jack with supplied cable into the auxiliary port as shown using the supplied audio RCA cable (iPod shown for demonstration purposes only).



#### B. Setting Up The MP3 Player for Use

1. Select preferred song/album/playlist prior plugging in MP3 Player and start playback.
2. Press "Source Button"  on stereo receiver or remote until the display reads "AU-1".

*Important Note: All external MP3 Playback operations are performed solely by the MP3 Player with the exception of volume control and "Source Button" selector, which can be controlled via wireless remote or on the stereo receiver.*



#### **WARNING: Electrical Shock Hazard Exists!**

Never install, handle or remove MP3 Player while hands are wet or while sitting partially or fully immersed.



## 19.7 Troubleshooting

### A. Unit will not turn-on

Make sure spa power is turned on, then check both harness fuses on back of unit making sure they are the proper ratings:

- Yellow memory B+ line (1A fuse); Red ACC line (10A fuse).
- With spa power off, use a thin rod to press the reset button located under the front panel.

### B. Fogged CDs and Lens





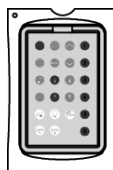

This condition may occur when it's cold. Wipe fogged CDs with a soft cloth. Fogged optical components inside the unit will return to normal operation after an hour in a heated environment.

## 19.8 Standard Wireless Remote Control













(Included With Optional Jacuzzi Sound System)

- Usable range 15' (5m)
- Never leave the remote under the spa cover for any reason.
- Battery Replacement: Use Coin Type, CR2025 or equivalent.



| Wireless Remote Control Command Summary   |   |   |  |
|---|---|---|--|
| Button  | Operation   | Button  | Operation  |
| <br>POWER  | Power Button: On/Off.   | <br>INTRO  | Intro/Station 1 Preset Button: <ul style="list-style-type: none"> <li>• In CD mode: provides a 5 second preview of each track.</li> <li>• In radio mode: plays preset station 1 or press and hold for 3 seconds to set station 1.</li> </ul> |
| <br>MUTE   | Mute Button: On/Off.  | <br>RANDOM | Random/Station 2 Preset Button: <ul style="list-style-type: none"> <li>• In CD mode: plays CD tracks in a random mode.</li> <li>• In radio mode: plays preset station 2 or press and hold to set station 2.</li> </ul>                       |
| <br>SOURCE | Source Button: Selects Radio, CD or iPod/MP3 Player function. | <br>REPEAT | Repeat/Station 3 Preset Button: <ul style="list-style-type: none"> <li>• In CD mode: repeats same CD track until the feature is deactivated.</li> <li>• In radio mode: plays preset station 3 or press and hold to set station 3.</li> </ul> |



| Button  | Operation   | Button  | Operation  |
|---|---|---|--|
|  | Auto Button: Scans through preset radio stations.   |  | Station 4 Preset Button: has no CD/Radio function. Press and hold to set station 4 or pause iPod when docked in Docking Station.                     |
|  | Audio Button: Selects treble, bass, fader or balance, audio settings.                     |  | Station 5 Preset Button: has no CD/Radio function. Press and hold to set station 5.  |
|  | Band Button: Selects AM or FM band.   |  | Station 6 Preset Button: has no CD/Radio function. Press and hold to set station 6.  |
|  | Volume Buttons: Zone 1 buttons are used to adjust volume levels. Zone 2 buttons not used. |  | Tune Buttons: <ul style="list-style-type: none"> <li>In CD mode: Advances/Rewinds tracks.</li> <li>In radio mode: Selects radio stations.</li> </ul> |
|  | Light Button: Turns spa light on/off (See Sec 9.5, page 25)                               |  | Jets 1 Button: Turns Jets pump 1 On and Off*   |
|  | Mode Button: Selects one of five light modes (See Sec. 9.6 page 25) for details.          |  | Jets 2 & 3 Button: Turns Jets pump 2 On and Off*   |

Note: Remote Control has no effect on MP3 Player playback if/when the generic MP3 cable output is used. (Sec 19.5 page 64)



## Wireless Remote Battery Replacement Procedure

1. Start by removing the rubber cover to the remote. (Figure A)

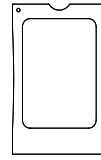
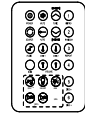

Fig. A



2. Turn the remote unit over and locate the battery door. (Figure B)

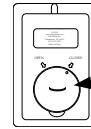

Fig. B

Battery Door

3. Rotate the battery door, with a coin, counterclockwise until the dot aligns with the Open arrow (Figure C).



Fig. C

4. Remove battery door using coin to pry the door upward (Figure D).

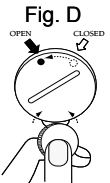

Fig. D

5. Replace battery using CR2025 or equivalent (Figure E).

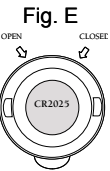

Fig. E

6. Reinstall the battery cover, using the coin to close (Figure F).

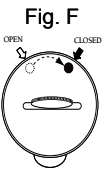

Fig. F

7. Reinstall rubber housing onto remote (Figure G).

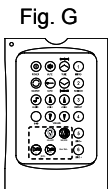

Fig. G

Note: Remote unit is water **resistant**, therefore the unit should never be left in the spa while the cover is on and spa is not in use.





NOTES:



NOTES:





Hot Tubs

**Jacuzzi® Hot Tubs**  
14525 Monte Vista Ave.  
Chino, CA 91710  
United States  
[www.jacuzzi.com](http://www.jacuzzi.com)

2530-442S, Rev. C

Printed In The USA