



POLYTEAK®

OWNER'S MANUAL

ITEM NAME : King Adirondack Chair

MODEL : KING-ADI

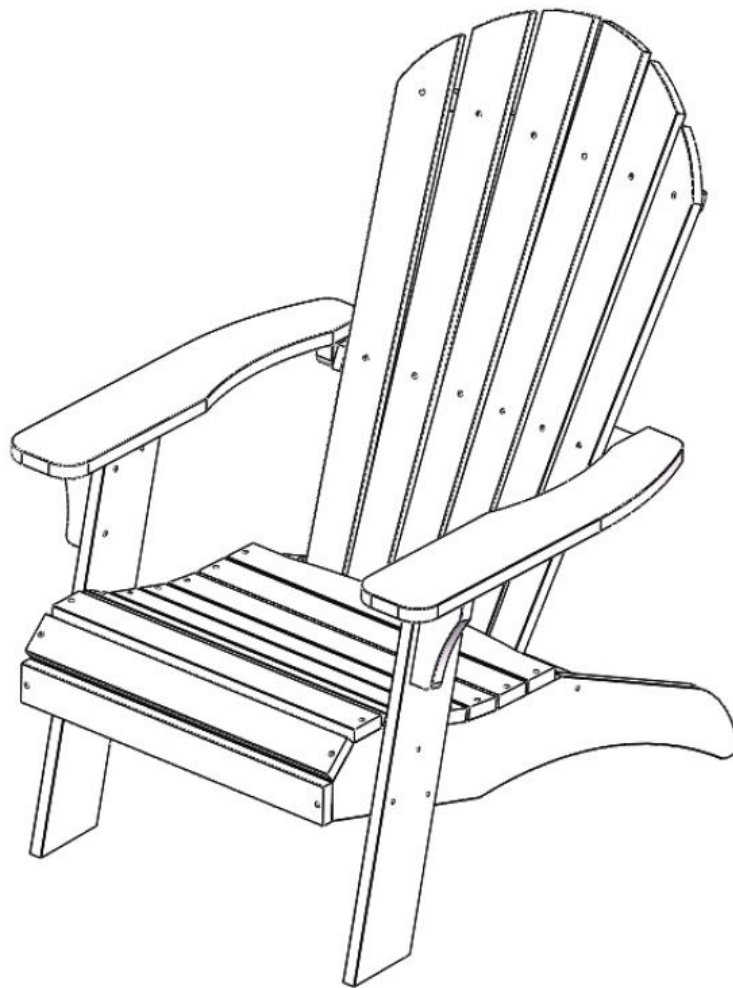

**For assistance with assembly, please contact customer service
1-949-316-0010 or Email: Support@polyteakoutdoor.com**

PRE-ASSEMBLY PREPARATION:



THIS PACKAGE MAY CONTAIN SMALL ITEMS WHICH SHOULD BE KEPT AWAY FROM CHILDREN

- Please check that all parts and hardware are included before beginning assembly.
- Save all packing materials until assembly is completed to avoid accidentally discarding small parts
- Read through the preparation and assembly instructions in full before beginning assembly.
- Please use CAUTION AND CARE WHEN LIFTING the product to avoid personal injury and (or) damage to the product.
- For ease of assembly, two adults are recommended; Assembly time: Approximately 30 minutes.

PANEL AND FITTINGS IDENTIFICATION:

A. Right Arm 1Pc

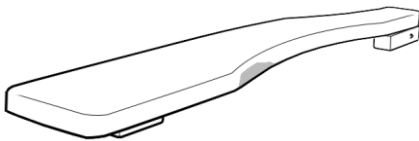

B. Left Arm 1Pc

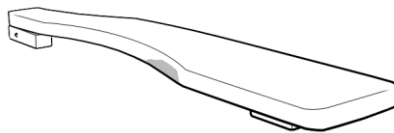

C. Pack Panel 1Pc

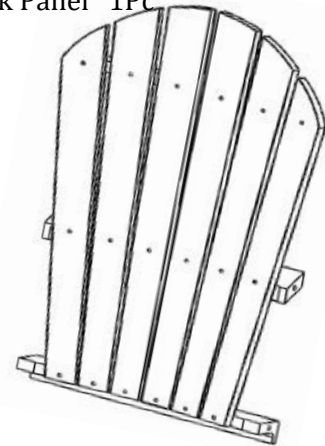

D. Seats 1Pc

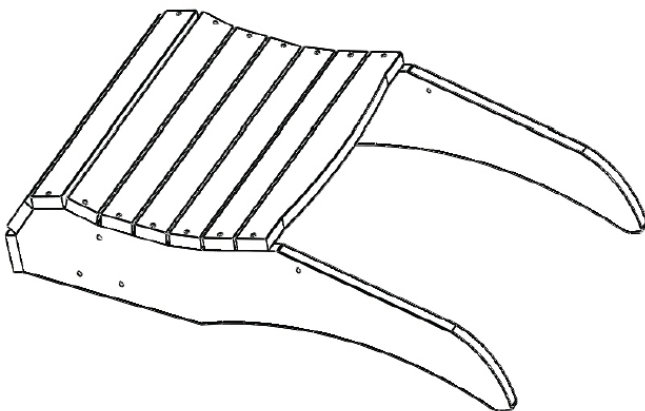

E/F. Legs 2Pcs

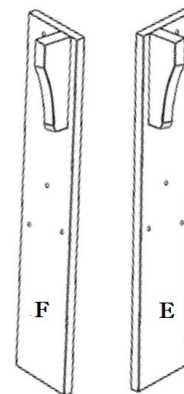

HARDWARE LIST:

G: Longer Bolt. 2-1/4"
2Pcs

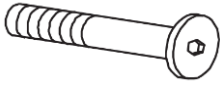

H: Short Bolt. 1-3/4" 10Pcs

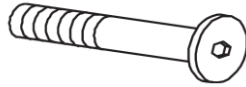

I. Allen wrench



J. Clean sponge



Missing Parts? Lost Hardware? Need Assistance?



WE CAN HELP!

For fastest service, contact us directly!

Phone:
(949) 316-0010

Email:
support@polyteakoutdoor.com



STRUCTURE DIAGRAM :

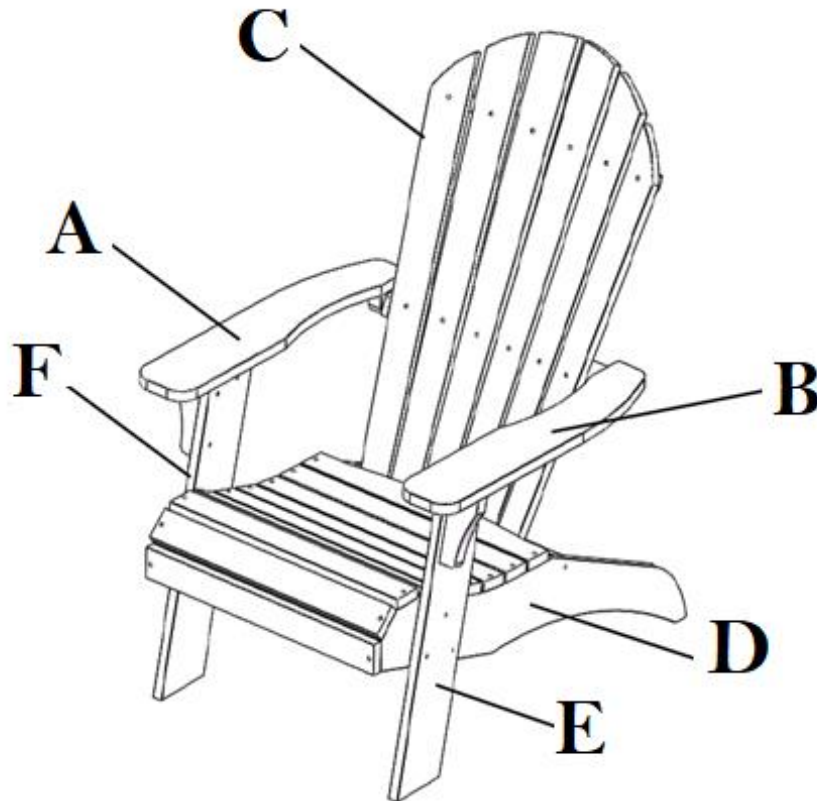

STEP-BY-STEP ASSEMBLY:

STEP 1: Attached the Leg (F and E) to the Seat Using 3 x Longer bolts (H) as per diagram.

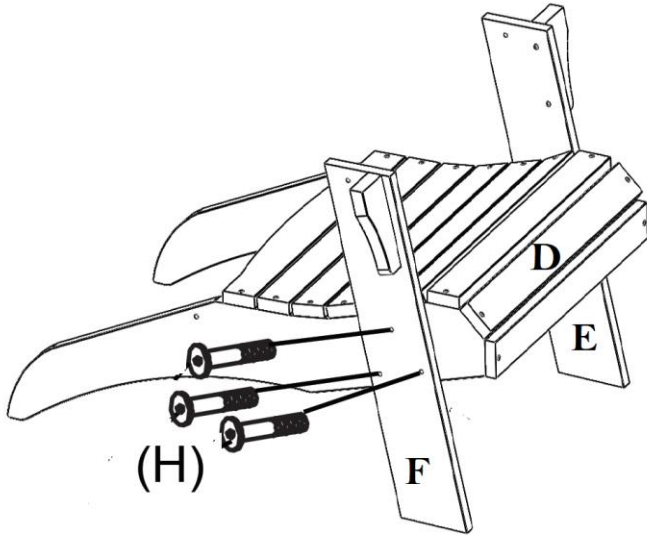

STEP 2: Attach Arms (A and B) to the Legs using 1 x Longer bolts (H) as per diagram.

Important note: Do Not Over Tighten Bolts

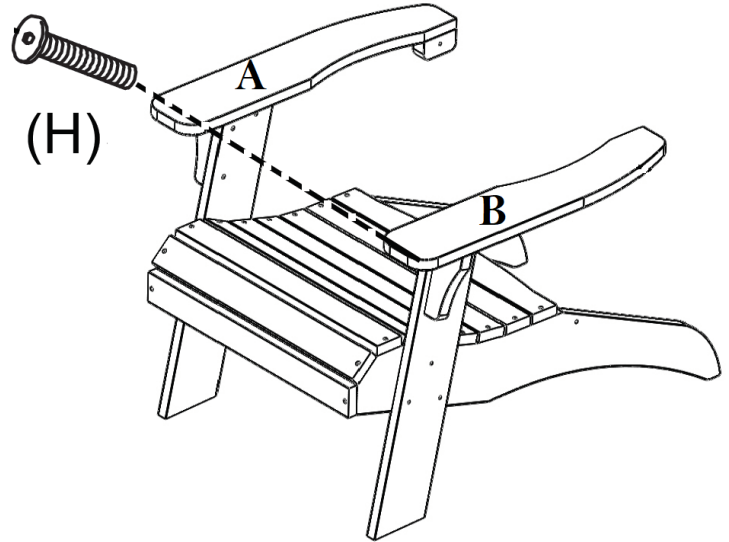

STEP 3: Attached Back panel (C) to the Seat and Arm using 1x Longer bolts (H) and 1x Shorter bolts(G) as per diagram.

Important note: Do Not Over Tighten Bolts

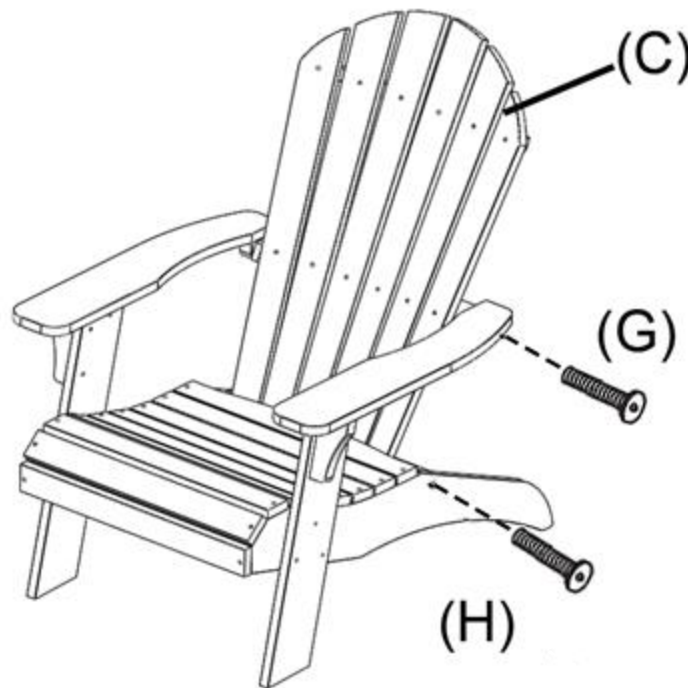



www.polyteakoutdoor.com
info@polyteakoutdoor.com
(949) 316-0010

CARE & MAINTENANCE

This furniture product is made of 100% PolyTEAK® lumber, an all-weather material that is naturally resistant to water. With the combination of marine-grade hardware and all-weather design, you can have complete confidence in leaving your newly acquired PolyTEAK furniture outside season after season.

Routine cleaning of the furniture can be completed with only warm water and soap, while bleach may be mixed with the water (25% Bleach, 75% Water) for extra cleaning power. A stiff bristle brush can help to remove any particles from between the simulated wood grain.

Comments or Questions?

Email: info@polyteakoutdoor.com

Phone: (949) 316-0010

Monday - Friday, 10AM - 5PM PST

WARRANTY REGISTRATION

Registering your product with PolyTEAK ensures that it will be covered by our manufacturer warranty.

To register your product, please visit:
www.polyteakoutdoor.com/pages/product-registration

**Think Green.
Think PolyTEAK®.**



Our PolyTEAK® products are all built tree-free and are 100% recyclable.







www.polyteakoutdoor.com
info@polyteakoutdoor.com
(949) 316-0010

TEA TIME

Dear friends,

Now, the setup is done, PolyTEAK hassle-free outdoor furniture has come! Sit back, enjoy our special recipe of ice-tea. Don't worry and have fun!

Refreshing your outdoor time	
Cold brew iced tea with Fresh Fruit recipe	
	4 bags of black tea
	6-8 sliced strawberries
	1/2 thinly sliced lemon
	Small handful basil leaves
	Put all in a pitcher then in refrigerate for 8 + hours.

Share your outdoor good time pictures with us on social media using #polyteak
You can find more refresh Outdoor Recipe from this link: www.FreePolyTeak.com/Recipes

Sincerely,
Tea Specialist from PolyTEAK Outdoor.