



Your Partner in Dentistry



# DENTAL INSTRUMENTS CATALOG

[www.hiteckmedical.com](http://www.hiteckmedical.com)

## SURGICAL

APICAL FORCEPS .....	4
ATRAUMAIR FORCEPS .....	4
SIYAH DEEP GRIP FORCEPS .....	5
GENERAL EXTRACTION FORCEPS .....	5
PEDIATRIC FORCEPS .....	7
ROOT FORCEPS .....	8
SURGICAL ELEVATORS .....	8
GENERAL ELEVATORS .....	10
SURGICAL ELEVATORS .....	11
LUXATING ELEVATORS .....	11
SIYAH LUXATING ELEVATORS .....	12
LUXATING HYBRID ELEVATORS .....	12
SCISSORS .....	13
NEEDLE HOLDERS .....	15
ASPIRATORS .....	17
BONE RONGEURS .....	17
CALIPERS .....	18
HEMOSTATS & CLAMPS .....	18
MALLET .....	19
DRESSING & TISSUE PLIERS .....	19
OSTEOTOMES .....	21
DRESSING & TISSUE PLIERS .....	21
PERIOSTEALS .....	22
RETRACTORS .....	24
ROOT TIP PICKS .....	25
SCALPEL HANDLES .....	26
BONE FILES .....	26
SURGICAL CURETTES .....	27
PERIODONTAL CHISELS .....	28
PERIODONTAL BONE CHISELS .....	28
PERIODONTAL KNIVES .....	29

BONE CHISELS .....	30
SYRINGES .....	30
SINUS LIFT .....	30

## DIAGNOSTIC

DRESSING TWEEZERS .....	31
MIRROR HANDLES .....	31
MIRRORS .....	31
SIYAH EXPLORERS .....	32
EXPLORERS .....	32
EXPROS .....	33
PROBES .....	34

## PERIODONTAL

SICKLE SCALERS .....	36
JACQUETTE SCALERS .....	36
MCCALL SCALER/CURRETTE SET .....	37
GOLDMAN FOX SCALER/CURRETTES .....	37
UNIVERSAL CURETTES .....	38
BARNHART UNIVERSAL CURETTES .....	39
TAHA SCALERS .....	39
GRACEY CURETTES .....	40
MINI GRACEY CURETTES .....	41
GRACEY CURETTES .....	42

## ENDODONTIC

ANTERIOR PLUGGERS .....	43
ENDO EXCAVATORS .....	43
ENDO EXPLORERS .....	43
ENDO ACCESSORIES .....	43
POSTERIOR PLUGGERS .....	44
ROOT FRAGMENT FORCEPS .....	44
ISO SIZED PLUGGERS .....	45
RUBBER DAM FORCEPS .....	46
RUBBER DAM PUNCH .....	46
RUBBER DAM FRAMES .....	46
RUBBER DAM CLAMPS .....	47

## RESTORATIVE

SIYAH COMPOSITE INSTRUMENTS .....	49
STANDARD COMPOSITE INSTRUMENTS .....	53
HATCHETS .....	54
MARGIN TRIMMERS .....	54
CHISELS .....	54
PLACEMENT INSTRUMENT .....	54
EXCAVATORS .....	55
AMALGAM .....	57
PLUGGERS/CONDENSERS .....	57
CARVERS .....	59
BURNISHERS .....	60
GOLDSTEIN CROWN REMOVERS .....	60
CHRISTENSEN CROWN REMOVERS .....	61
TEMPORARY CROWN REMOVERS .....	61
SPATULAS & KNIVES .....	61

MEASURING DEVICES & WAX CARVERS .....	62
P.K THOMAS INSTRUMENTS .....	62

## ORTHODONTIC

CLEAR ALIGNER INSTRUMENTS .....	63
CUTTERS .....	64
UTILITY PLIERS .....	65
WIRE FORMING PLIERS .....	67
STEEL PHOTOGRAPHY MIRRORS .....	69
HAND INSTRUMENTS .....	70

## INSTRUMENT MANAGEMENT

PREMIUM SERIES CASSETTES .....	72
DAILY LINE CASSETTES .....	77
ACCESSORY CASSETTES .....	78

APICAL FORCEPS



**AF1 Standard Apical**  
Upper Anteriors  
**2524 | \$139.99**



**AF150 Apical**  
Upper Universal  
**2525 | \$139.99**



**AF151 Apical**  
Lower universal  
**2526 | \$139.99**



**AF222 Apical**  
Lower Molars  
**2527 | \$139.99**



**AF67A Apical**  
Upper Molars  
**2528 | \$139.99**



**AF74N Apical**  
Lower Anteriors  
**2529 | \$139.99**



**21 Atraumair**  
1st & 2nd Upper Molars  
**F21XS \$159.99**  
**F21XSD \$249.99**  
Diamond Coated



**44 Atraumair**  
Upper Roots  
**FX44XS \$159.99**  
**FX44XSD \$249.99**  
Diamond Coated



**67 Atraumair**  
Upper Molars  
**F67XS \$159.99**  
**F67XSD \$249.99**  
Diamond Coated



**1 Atraumair**  
Upper Incisors  
**F1XS \$159.99**  
**F1XSD \$249.99**  
Diamond Coated



**1 Apical Atraumair**  
Upper Incisors  
**FAF1XS \$159.99**  
**FAF1XSD \$249.99**  
Diamond Coated



**35 Atraumair**  
Upper Canines & Premolars  
**F35XS \$159.99**  
**F35XSD \$249.99**  
Diamond Coated



**36 Atraumair**  
Lower Incisors  
**F36XS \$159.99**  
**F36XSD \$249.99**  
Diamond Coated



**36 Apical Atraumair**  
Lower Premolars & Incisors  
**FAF36XS \$159.99**  
**FAF36XSD \$249.99**  
Diamond Coated



**13 Atraumair**  
Lower Premolars  
**F13XS \$159.99**  
**F13XSD \$249.99**  
Diamond Coated



**51 Atraumair**  
Upper roots, serrated  
**FX51XS \$159.99**  
**FX51XSD \$249.99**  
Diamond Coated



**79 Atraumair**  
Lower Molars  
**FX79XS \$159.99**  
**FX79XSD \$249.99**  
Diamond Coated



**73 Atraumair**  
Lower Molars  
**FX73XS \$159.99**  
**FX73XSD \$249.99**  
Diamond Coated



**23 Cowhorn Atraumair**  
Lower Molars  
**F23XS | \$159.99**



**45 Atraumair**  
Lower Roots, Serrated  
**F45XS \$159.99**  
**F45XSD \$249.99**  
Diamond Coated



**35 Apical Atraumair**  
Upper Canines, Premolars & Molars  
**FAF35XS \$159.99**  
**FAF35XSD \$249.99**  
Diamond Coated

The Siyah Deep Grip Forceps are coated with Aluminium Titanium Nitride that is significantly harder, scratch-resistant and non-reflective for long lasting performance.

Increased hardness ensures long-term integrity of both the beak serrations and forceps overall.

- Extremely smooth surface seals the pores of the stainless steel, minimizing protein adhesion and reducing time to clean.
- Matte finish that reduces distracting glare and reflections mid-procedure.
- Machined beaks give you precision and control over your extractions.

ATRAUMAIR FORCEPS



**Upper Anterior**  
SEF902 | \$279.99



**Upper Universal**  
SEF903 | \$279.99



**Lower Universal**  
SEF904 | \$279.99



**Universal Upper Molars**  
SEF905 | \$279.99



**Lower Anteriors**  
Lower anteriors  
SEF906 | \$279.99



**Lower Molars**  
Lower molars  
SEF907 | \$279.99



**13 Serrated**  
Lower Premolars  
1423 | \$124.99



**151 Cryer Universal**  
Lower Incisors, canines  
& premolars & roots  
1498 | \$124.99



**Lower Roots**  
Serrated spade tip  
SEF908 | \$279.99



**Upper Roots**  
Serrated spade tip  
SEF909 | \$279.99



**62**  
Upper & Lower Incisors,  
Canines & Premolars  
1480 | \$124.99



**101 Hull**  
Upper & Lower  
Premolars  
EF03 | \$124.99

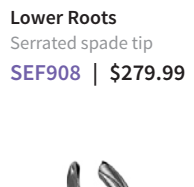

**151A Cryer Universal**  
Lower Incisors, canines  
& premolars & roots  
1499 | \$124.99

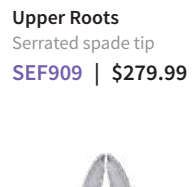

**151AS Split Beak**  
Lower Incisors, canines  
& premolars & roots  
1501 | \$124.99



**MD3 Mead Serrated**  
Lower incisors & roots  
EF06 | \$124.99



**1 Serrated**  
Upper Anteriors  
1401 | \$124.99



**2**  
Upper & Side Incisors  
1402 | \$124.99

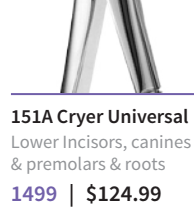

**7 Serrated**  
Upper premolars  
1403 | \$124.99

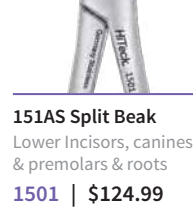

**4**  
Lower Incisors & Canines  
1422 | \$124.99



**1 Standard**  
Upper Incisors & Canines  
1473 | \$124.99



**203**  
Lower Incisors, Canines  
& Premolars  
EF13 | \$124.99



**32 Parnly**  
Upper Incisors & Canines  
1478 | \$124.99



**32A Parnly**  
Upper Incisors & Canines  
1479 | \$124.99



**150 Cryer Universal**  
Upper Incisors & Canines  
1487 | \$124.99



**150A Cryer Parallel  
Beaks**  
Upper Incisors & Canines  
1488 | \$124.99



**150AS Split Beaks  
Serrated**  
Upper Incisors & Canines  
1490 | \$124.99



**1A Henahan**  
Upper Incisors & Canines  
1474 | \$124.99



**22 Serrated**  
Lower molars

**1424** | \$124.99



**22 Serrated**  
Lower molars

**1435** | \$124.99



**73 Serrated**  
Lower Molars

**1440** | \$124.99



**79 Serrated**  
Lower Molars

**1494** | \$124.99



**17**  
Lower Molars

**1496** | \$124.99



**23 Cowhorn**  
Lower Molars

**1497** | \$124.99



**222**  
Lower molars

**1503** | \$124.99



**3FS Woodward**  
Lower Molars

**EF14** | \$124.99



**217**  
Lower Molars

**EF15** | \$124.99



**MD4 Mead**  
Lower Molars

**EF16** | \$124.99



**36 Serrated**  
Lower Premolars

**FX36E** | \$124.99



**17 Serrated**  
Upper Molars

**1404** | \$124.99



**18 Serrated**  
Upper Molars

**1405** | \$124.99



**67A Serrated**  
Upper Molars

**1415** | \$124.99



**10S**  
Upper Molars

**1475** | \$124.99



**18L Harris**  
Upper Molars

**1476** | \$124.99



**18R Harris**  
Upper Molars

**1477** | \$124.99



**53L**  
Upper Molars

**1481** | \$124.99



**53R**  
Upper Molars

**1482** | \$124.99



**88L Nevius**  
Upper Molars

**1485** | \$124.99



**88R Nevius**  
Upper Molars

**1486** | \$124.99



**89 Cook**  
Upper Molars

**EF07** | \$124.99



**90 Cook**  
Upper Molars

**EF09** | \$124.99



**210H**  
Upper Molars

**EF10** | \$124.99



**210S**  
Upper Molars

**EF11** | \$124.99



**MD2 Mead Serrated**  
Upper Molars

**EF12** | \$124.99



**30**  
Upper Molars

**FX30E** | \$124.99



**34 Special**  
Upper Incisors & Canines

**FX34E** | \$124.99



**1S Standard**  
Upper Incisors & Canines  
**F1S | \$124.99**



**16S**  
Lower Molars  
**F16S | \$124.99**



**23S**  
1st & 2nd Lower Molars  
**F23S | \$124.99**



**39**  
1st & 2nd Lower Molars  
**F39 | \$124.99**



**40**  
Lower Primary Molars  
**F40 | \$124.99**



**150XAS Split Beak**  
Upper Primary Universal  
**F150XAS | \$124.99**



**151XAS Split Beak**  
Lower Primary Molars  
**F151XAS | \$124.99**



**150SR Rainbow**  
Upper Primary Teeth & Roots  
**F150SR | \$124.99**



**151SR Rainbow**  
Lower Primary Teeth & Roots  
**F151SR | \$124.99**



**150S Universal**  
Upper Primary Teeth & Roots  
**F150S | \$124.99**



**151S Universal**  
Lower Primary Teeth & Roots  
**F151S | \$124.99**



**1C**  
Lower incisors  
**FX1CE | \$124.99**



**2C**  
Lower Incisors  
**FX2CE | \$124.99**



**3C**  
Lower roots  
**FX3CE | \$124.99**



**4C**  
Upper premolars  
**FX4CE | \$124.99**



**5CE**  
Upper incisors & canines  
**FX5CE | \$124.99**



**6C**  
Upper molars  
**FX6CE | \$124.99**



**7C**  
Upper Roots  
**FX7CE | \$124.99**



**23K Cowhorn**  
Lower Primary Molars  
**F23K | \$124.99**



**150K**  
Upper Primary Incisors & Roots  
**F150K | \$124.99**



**151K**  
Lower Primary Incisors & Roots  
**F151K | \$124.99**



**49 Serrated**  
Upper roots  
**1410 | \$124.99**



**51 Serrated**  
Upper roots  
**1411 | \$124.99**



**97 Serrated**  
Upper Roots  
**1419 | \$124.99**



**33 Serrated**  
Lower Roots  
**1427 | \$124.99**



**46L Serrated**  
Lower roots  
**1433 | \$124.99**



**74 Serrated**  
Lower roots  
**1436 | \$124.99**



**74N Serrated**  
Lower Roots, Narrow Beaks  
**1437 | \$124.99**



**86A**  
Lower Molars  
**1443 | \$124.99**



**233 Serrated**  
Lower Roots  
**1448 | \$124.99**



**65**  
Upper Roots, Fragments & Overlapping Incisors  
**1483 | \$124.99**



**69**  
Upper & Lower Fragments & Roots  
**1484 | \$124.99**



**300 Serrated**  
Upper roots  
**2530 | \$124.99**



**301 Serrated**  
Lower roots  
**2531 | \$124.99**



**76S Serrated**  
Upper roots  
**2532 | \$124.99**



**87**  
Lower Molars  
**FX87E | \$124.99**



**34S Seldin**  
**E1 | \$89.99**



**77R Serrated**  
Serrated  
**E2 | \$89.99**



**301 Apexo**  
**E3 | \$89.99**



**B Cogswell**  
**E4 | \$89.99**



**21 Cryer**  
Mini  
**E5 | \$89.99**



**22 Cryer**  
Mini  
**E6 | \$89.99**



**44 Cryer**  
Small  
**E7 | \$89.99**



**45 Cryer**  
Small  
**E8 | \$89.99**



**25 Cryer**  
Medium  
**E9 | \$89.99**



**26 Cryer**  
Medium  
**E10 | \$89.99**



**31 Cryer**  
Large  
**E11 | \$89.99**



**32 Cryer**  
Large  
**E12 | \$89.99**





A30 Cryer  
E13 | \$89.99



A31 Cryer  
E14 | \$89.99



1 Heidbrink  
E15 | \$89.99



2 Heidbrink  
E16 | \$89.99



40 Heidbrink  
E17 | \$89.99



41 Heidbrink  
E18 | \$89.99



1L Seldin  
Upper & Lower Molar  
Roots, Left  
E19 | \$89.99



1R Seldin  
Upper & Lower Molar  
Roots, Right  
E20 | \$89.99



2S Seldin  
Lower 3rd Molars  
E21 | \$89.99



3S Seldin  
Upper & Lower Anterior  
Roots  
E22 | \$89.99



34 Seldin  
Upper & Lower Anterior  
Roots  
E23 | \$89.99



4L Seldin  
E24 | \$89.99



4R Seldin  
E25 | \$89.99



301W Seldin  
E26 | \$89.99



304W Seldin  
E27 | \$89.99



4 Schmeckebier  
E28 | \$89.99



5 Schmeckebier  
E29 | \$89.99



71 Miller Apexo  
E30 | \$89.99



72 Miller Apexo  
E31 | \$89.99



73 Miller Apexo  
E32 | \$89.99



74 Miller Apexo  
E33 | \$89.99



302 Apexo  
E34 | \$89.99



303 Apexo  
E35 | \$89.99



1C Coupland Gouge  
E36 | \$89.99



2C Coupland Gouge  
E37 | \$89.99



3C Coupland Gouge  
E38 | \$89.99



A1C Coupland Gouge  
E39 | \$89.99



A2C Coupland Gouge  
E40 | \$89.99



A3C Coupland Gouge  
E41 | \$89.99



6 Potts  
E42 | \$89.99  
E79 | T Bar | \$89.99



7 Potts  
E43 | \$89.99  
E80 | T Bar | \$89.99



Lindo Levian  
1527 | \$89.99



1 Bein, Large  
E124 | \$89.99



2 Bein, Medium  
E125 | \$89.99



3 Bein, Small  
E126 | \$89.99



8 Crane Pick  
E44 | \$89.99



11 Stout  
3rd Molars  
E45 | \$89.99



11A Stout  
3rd Molars  
E46 | \$89.99



11M MacMillan Gouge  
E47 | \$89.99



12M MacMillan Gouge  
E48 | \$89.99



13M MacMillan Gouge  
E49 | \$89.99



15 Woodward  
Lower Molar Roots  
E50 | \$89.99



16 Woodward  
Lower Molar Roots  
E51 | \$89.99



19  
E52 | \$89.99



20  
E53 | \$89.99



23  
E54 | \$89.99



31F Friedman Gouge  
E55 | \$89.99



32F Fridman Gouge  
E56 | \$89.99



38, Serrated  
E57 | \$89.99



39, Serrated  
E58 | \$89.99



44C Bradley  
E59 | \$89.99



46  
E60 | \$89.99



46R  
E61 | \$89.99



51 Curtis  
E62 | \$89.99



52 Curtis  
E63 | \$89.99



63 Elevator  
E64 | \$89.99



69W Woodward  
E65 | \$89.99



77, Serrated  
E66 | \$89.99



80  
E67 | \$89.99



81  
E68 | \$89.99



81A  
E69 | \$89.99



81E  
E70 | \$89.99



92, Serrated  
E71 | \$89.99



93, Serrted  
E72 | \$89.99



98  
E73 | \$89.99



190  
E74 | \$89.99



191  
E75 | \$89.99



A Cogswell  
E76 | \$89.99



H5 Hourigan  
Serrated  
E77 | \$89.99



H6 Hourigan  
Serrated  
E78 | \$89.99



Warwick-James Straight  
E81 | \$89.99



Warwick-James Left  
E82 | \$89.99



Warwick-James Right  
E83 | \$89.99



11LX, Cross-Bar Handle  
E84 | \$89.99



1RX, Cross-Bar Handle  
E85 | \$89.99



11LX, Cross-Bar Handle  
E86 | \$89.99



11RX, Cross-Bar Handle  
E87 | \$89.99



12LX, Cross-Bar Handle  
E88 | \$89.99



12RX, Cross-Bar Handle  
E89 | \$89.99



14LX, Cross-Bar Handle  
E90 | \$89.99



14RX, Cross-Bar Handle  
E91 | \$89.99



Bernard  
E114 | Regular | \$89.99  
E115 | Right | \$89.99  
E116 | Left | \$89.99



Curved, 3 mm  
E94 | Regular | \$89.99  
E94S | Serrated | \$89.99



Straight, 3 mm  
E95 | Regular | \$89.99  
E95S | Serrated | \$89.99



Curved, 2 mm  
E92 | Regular | \$89.99  
E92S | Serrated | \$89.99



Straight, 2 mm  
E93 | Regular | \$89.99  
E93S | Serrated | \$89.99



Curved, 4 mm  
E96 | Regular | \$89.99  
E96S | Serrated | \$89.99



Straight, 4 mm  
E97 | Regular | \$89.99  
E97S | Serrated | \$89.99



Curved, 5 mm  
E98 | Regular | \$89.99  
E98S | Serrated | \$89.99



Straight, 5 mm  
E99 | Regular | \$89.99  
E99S | Serrated | \$89.99



Curved, 2 mm

- EL2CX | Regular | \$109.99
- EL2CXS | Serrated | \$109.99
- SEL2CX | Slim Long | \$109.99
- SSEL2CX | Slim Short | \$109.99



Straight, 2 mm

- EL2SX | Regular | \$109.99
- EL2SXS | Serrated | \$109.99
- SEL2SX | Slim Long | \$109.99
- SSEL2SX | Slim Short | \$109.99



Curved, 3 mm

- EL3CX | Regular | \$109.99
- EL3CXS | Serrated | \$109.99
- SEL3CX | Slim Long | \$109.99
- SSEL3CX | Slim Short | \$109.99



Straight, 3 mm

- EL3SX | Regular | \$109.99
- EL3SXS | Serrated | \$109.99
- SEL3SX | Slim Long | \$109.99
- SSEL3SX | Slim Short | \$109.99



Curved, 4 mm

- EL4CX | Regular | \$109.99
- EL4CXS | Serrated | \$109.99
- SEL4CX | Slim Long | \$109.99
- SSEL4CX | Slim Short | \$109.99



Straight, 4 mm

- EL4SX | Regular | \$109.99
- EL4SXS | Serrated | \$109.99
- SEL4SX | Slim Long | \$109.99
- SSEL4SX | Slim Short | \$109.99



Curved, 5 mm

- EL5CX | Regular | \$109.99
- EL5CXS | Serrated | \$109.99
- SEL5CX | Slim Long | \$109.99
- SSEL5CX | Slim Short | \$109.99



Straight, 5 mm

- EL5SX | Regular | \$109.99
- EL5SXS | Serrated | \$109.99
- SEL5SX | Slim Long | \$109.99
- SSEL5SX | Slim Short | \$109.99



Large, Distal  
E100 | \$149.99



Small, Curved  
E101 | \$149.99



Small, Straight  
E102 | \$149.99



Small, Distal  
E103 | \$149.99



Small, Mesial  
E104 | \$149.99



Large, Mesial  
E105 | \$149.99



Straight Spade  
E117 | \$149.99



Distal Spade  
E118 | \$149.99



Mesial Spade  
E119 | \$149.99



Angled Right Spade  
E120 | \$149.99



Angled Left Spade  
E121 | \$149.99



Straight, Large  
4.5mm  
E122 | \$149.99



Curved, Large  
4.5mm  
E123 | \$149.99



**Iris, Tungsten Carbide**  
 05-1842-11 | 11.5 CM Straight | \$99.99  
 05-1843-11 | 11.5 CM Curved | \$99.99



**Iris**  
 05-1484-11 | 11.5 CM Straight | \$39.99  
 04-1485-11 | 11.5 CM Curved | \$39.99



**Siyah Iris, Serrated**  
 05-1842-11C | 11.5 CM Curved | \$129.99  
 05-1843-11C | 11.5 CM Straight | \$129.99

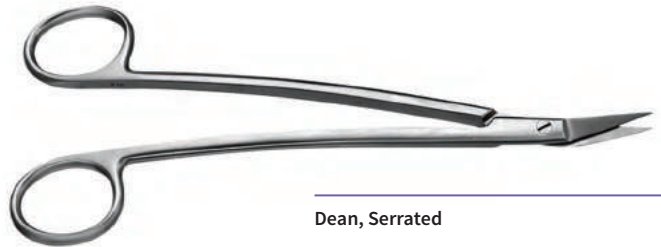

**Dean, Serrated**  
 05-1652-17 | 17 CM | \$59.99

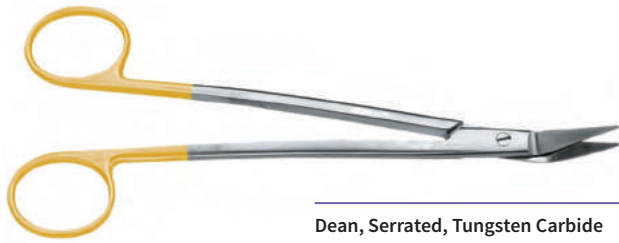

**Dean, Serrated, Tungsten Carbide**  
 200-133 | 16.5 CM | \$109.99



**Kelly, Serrated**  
 05-1454-16 | 16 CM Straight | \$59.99  
 05-1454-18 | 18 CM Curved | \$64.99  
 05-1455-16 | 16 CM Straight | \$59.99  
 05-1455-18 | 18 CM Curved | \$64.99



**Kelly, Serrated, Tungsten Carbide**  
 200-131 | 16 CM Curved | \$114.99  
 200-132 | 16 CM Straight | \$114.99



**Goldman Fox, Serrated**  
 05-1645-13 | 16 CM Curved | \$49.99  
 05-1646-13 | 16 CM Straight | \$49.99



**Goldman Fox Tungsten, Serrated**  
 05-1840-13 | 13CM Straight | \$114.99  
 05-1841-13 | 13CM Curved | \$114.99



**Siyah Goldman Fox, Serrated**  
 05-1840-13C | 13CM Straight | \$164.99  
 05-1841-13C | 13CM Curved | \$164.99



**LaGrange, S Shape**  
 05-1659-11 | 13CM Straight | \$44.99  
 05-1659-15 | 13CM Curved | \$44.99



**Siyah LaGrange, S Shape, Serrated**  
 05-1659-11C | 13CM Straight | \$129.99  
 05-1659-15C | 13CM Curved | \$149.99



**Spencer Stitch**

- 05-1601-11 | 11.5 CM Angled | \$39.99
- 05-1598-11 | 11.5 CM Straight | \$39.99
- 05-1598-16 | 16 CM Straight | \$39.99
- 05-1598-09 | 9 CM Straight | \$37.99



**Locklin**

- 05-1654-16 | 16.5 CM Angled Shanks | \$43.99
- 05-1655-16 | 16.5 CM Straight Shanks | \$43.99

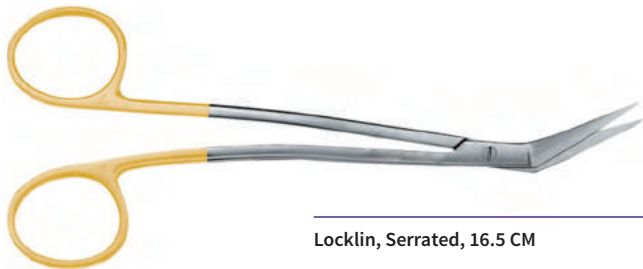

**Locklin, Serrated, 16.5 CM**

- 200-134 | Curved Shanks | \$109.99
- 200-135 | Straight Shanks | \$114.99



**Metzenbaum, Blunt Tips**

- 05-1819-14 | 14.5 CM Straight | \$109.99
- 05-1825-18 | 18 CM Straight | \$114.99
- 05-1822-14 | 14.5 CM Curved | \$109.99
- 05-1828-18 | 18 CM Straight | \$114.99



**Mayo**

- 05-1813-14 | 14.5 CM Straight | \$104.99
- 05-1814-14 | 14.5 CM Curved | \$104.99



**Universal Wire Cutting, Serrated**

- 05-1839-12 | 12 CM Angled | \$94.99



**Metzenbaum, Pointed**

- 200-136 | 15 CM Straight | \$109.99
- 200-137 | 15 CM Curved | \$109.99



**Siyah Metzenbaum, Serrated**

- 05-1773-14C | 14 CM Curved | \$164.99
- 05-1772-14C | 14 CM Straight | \$164.99
- 05-1848-18 | 18 CM CVD | \$184.99
- 05-1868-18 | 18 CM STR | \$184.99



**Micro Castroviejo Curved**

- S31 | 10cm | \$249.99



**Castroviejo Scissor**

- 2517 | 18 CM Straight | \$189.99



**Barraquer Needle Holder**

- 2512 | 16 CM, Straight | \$249.99
- 2513 | 18 CM, Straight | \$279.99
- 2514 | 16 CM, Curved | \$249.99
- 2515 | 18 CM, Curved | \$279.99



**Mathieu**

- 1753 | 14 CM | \$64.99
- 1753-17 | 17 CM | \$73.99
- 1753-20 | 20 CM | \$79.99



**Crile Wood**

- 09-2515-15 | 15 CM with Groove | \$64.99



**Mayo Hegar**

- 09-2511-16 | 16 CM | \$64.99
- 09-2512-14 | 14 CM | \$64.99

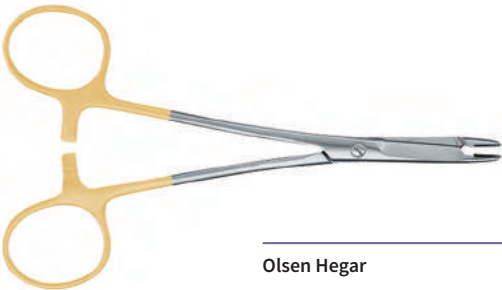

**Olsen Hegar**

- 09-2693-14 | 14 CM | \$129.99
- 09-2692-11 | 11 CM | \$129.99
- 09-2694-17 | 17 CM | \$139.99



**Crile Wood**

- 09-2661-15 | 15 CM | \$99.99
- 09-2661-18 | 18 CM | \$127.99
- 09-2661-15L | 15 CM, Left Handed | \$124.99

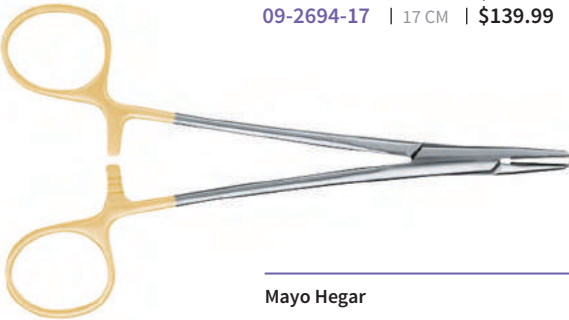

**Mayo Hegar**

- 09-2652-16 | 16 CM | \$139.99
- 09-2652-13 | 13 CM | \$99.99
- 09-2511-18 | 18 CM | \$127.99
- 09-2653-14 | 14 CM Curved | \$99.99



**Mini Ryder**

- 200-124 | 15 CM | \$149.99
- 200-125 | 18 CM | \$149.99



**Micro Vascular**

- 200-123 | 18 CM | \$149.99



**Title**

- 09-2648-13 | 15 CM | \$149.99



**Hegar Baumgartner**  
09-2654-14 | 14 CM | \$99.99

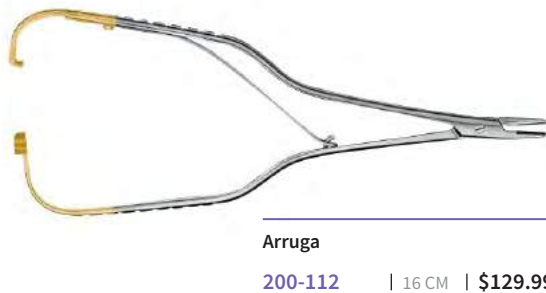

**Arruga**  
200-112 | 16 CM | \$129.99

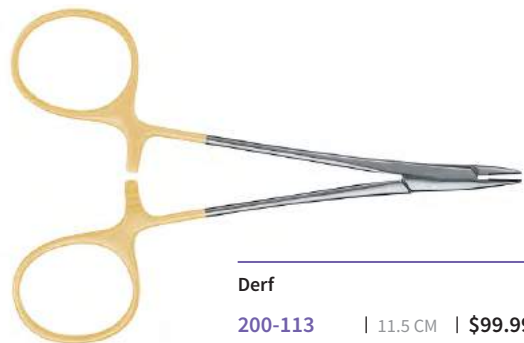

**Derf**  
200-113 | 11.5 CM | \$99.99



**Halsey**  
200-114 | 13 CM | \$99.99  
200-116 | 13 CM Smooth | \$99.99



**Lichtenberg**  
200-115 | 20 CM | \$149.99  
200-126 | 17 CM | \$149.99



**DeBakey, Delicate**  
200-117 | 18 CM | \$134.99

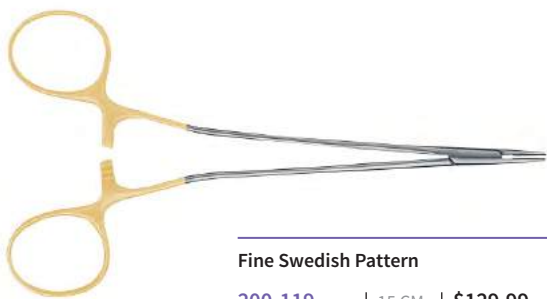

**Fine Swedish Pattern**  
200-119 | 15 CM | \$129.99



**Mathiu Kocher**  
200-120 | 14 CM | \$109.99



**HMT Thin Jaw**  
200-118 | 15 CM | \$129.99



**Mathiu**  
200-121 | 14 CM | \$109.99





**Yankauer**

- 1359** | 20 CM | **\$74.99**
- 1360** | 27 CM | **\$88.99**

**Frazier Suction Tube**

- 1362** | 1.5 mm  $\circ$  | **\$94.99**
- 1363** | 2.0 mm  $\circ$  | **\$94.99**
- 1364** | 2.5 mm  $\circ$  | **\$94.99**
- 1365** | 3.0 mm  $\circ$  | **\$94.99**



**15CM Mini Friedman Bone Rongeur**

- 1599** | Straight | **\$154.99**
- 1600** | 30° | **\$154.99**
- 1601** | 45° | **\$154.99**
- 1602** | 90° | **\$154.99**



**Friedman Bone Rongeur**

- 1603** | 30° | **\$154.99**
- 1604** | 45° | **\$154.99**



**30° Cleaveland Side Cutting**

- 1614** | 14CM | **\$154.99**
- 1615** | 17CM | **\$154.99**



**15CM Blumenthal**

- 1621** | 30° | **\$154.99**
- 1622** | 45° | **\$154.99**
- 1623** | 90° | **\$154.99**



**30° Cleaveland Bone Rongeur**

- 1612** | 14CM | **\$154.99**
- 1613** | 17CM | **\$154.99**



**90MM Shaft Kerrison Shortnose**

- 1618** | 2MM Tip | **\$289.99**
- 1619** | 3 MM Tip | **\$289.99**
- 1620** | 5 MM Tip | **\$289.99**



**15CM Bohler Bone Rongeur**

- 1609** | Straight | **\$154.99**



**12CM Mini Friedman Bone Rongeur**

- 1605** | 30° | **\$154.99**



**18 CM Weiss Modified**  
**CAL1** | Straight | **\$164.99**  
**CAL2** | Curved | **\$164.99**



**18 CM Standard**  
**CAL3** | Straight | **\$164.99**  
**CAL4** | Curved | **\$164.99**



**11 CM Rounded Castroviejo**  
**CAL5** | Straight | **\$114.99**  
**CAL6** | Curved | **\$114.99**



**18 CM Rounded Castroviejo**  
**CAL7** | Straight | **\$164.99**  
**CAL8** | Curved | **\$164.99**



**16 CM Kelly Rankin Artery Forcep**  
**07-2130-16** | Straight | **\$33.99**  
**07-2131-16** | Curved | **\$33.99**



**12 CM Halstead Mosquito Forcep**  
**07-2113-12** | Straight | **\$31.99**  
**07-2114-12** | Curved | **\$31.99**



**12 CM Halstead Mosquito Forcep**  
**07-2115-12** | Straight | **\$31.99**  
**07-2116-12** | Curved | **\$31.99**



**14 CM Ochsner Kocher Artery Forcep**  
**07-2156-14** | Straight | **\$33.99**  
**07-2157-14** | Curved | **\$33.99**



**16 CM Rochester Pean Fine Artery Forcep**  
**07-2154-16** | Straight | **\$33.99**  
**07-2155-16** | Curved | **\$33.99**



**18 CM Adson Artery Forcep**  
**07-2177-18** | Straight | **\$39.99**  
**07-2178-18** | Curved | **\$39.99**



**Kelly Artery Forcep, Half Serrated**  
**07-2128-14** | 14 CM Straight | **\$33.99**  
**07-2129-14** | 14 CM Curved | **\$33.99**



#1 Mead Mallet

MAL1 | \$99.99



Allis Tissue

26-13502-15 | 5x6 Teeth | \$44.99



12 CM Adson Forcep

06-1919-12 | Dressing, Serrated | \$42.99

06-1981-12 | Tissue 1x2 Teeth | \$42.99



12 CM Adson Brown

06-1984-12-6 | 5x6 Teeth | \$42.99

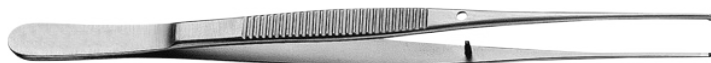

Semken, 12.5 CM

06-1964-12 | 1x2 Teeth, Straight | \$42.99

06-1965-12 | 1x2 Teeth Curved | \$42.99

06-1921-12 | Serrated, Straight | \$42.99

06-1922-12 | Serrated, Curved | \$42.99



18 CM Gerald Tissue

06-1970-18 | 1x2 Teeth, Straight | \$44.99

06-2047-18 | 1x2 Teeth, Curved | \$44.99

06-1923-18 | Serrated, Straight | \$44.99

06-1924-18 | Serrated, Curved | \$44.99



20 Corn Suture Plier

200-110 | 15 CM | \$44.99

200-111 | Micro | \$109.99



**Russian Tissue Forcep**

**200-108** | 15 CM | **\$49.99**  
**200-109** | 20 CM | **\$54.99**



**Fox Tissue, 3x3 Teeth**

**TP-50** | 15 CM | **\$42.99**  
**TP-50L** | 15 CM, Locking | **\$49.99**



**Adson Forcep, Tungsten Carbide, 12 CM**

**06-2033-12** | Serrated | **\$99.99**  
**06-2044-12** | 1x2 Teeth | **\$99.99**



**Adson Brown, 3x4 Teeth**

**06-2045-12** | 15 CM | **\$99.99**



**Debaquey Atraumatic, 2.0 MM**

**14-4109-16** | 15 CM | **\$109.99**  
**14-4109-20** | 20 CM | **\$119.99**



**Potts Smith, Serrated**

**06-2041-18** | 18 CM | **\$109.99**  
**06-2041-20** | 20 CM | **\$114.99**



**Cushing Dressing, Tungsten Carbide, Serrated 18 CM**

**06-2038-18** | 18 CM, Angled | **\$109.99**  
**06-2037-18** | 18 CM, Straight | **\$109.99**  
**200-107** | 16.5 CM, Bayonet | **\$109.99**



**18 CM Gerald Tissue, Tungsten Carbide**

**200-105** | Serrated | **\$109.99**  
**200-106** | 1x2 Teeth | **\$109.99**



**Flat Osteotome, 7-10-13-15-18 MM Markings**

<b>2303</b>	4 MM, Straight	\$89.99
<b>2304</b>	4 MM, Curved	\$89.99
<b>2305</b>	7.5 MM, Straight	\$89.99
<b>2306</b>	7.5 MM, Curved	\$89.99



**Round Osteotome, 7-8-13-15-18 MM Markings**

<b>2308</b>	#1, 2.7 MM	\$99.99
<b>2309</b>	#2, 3.2 MM	\$99.99
<b>2310</b>	#3, 3.7 MM	\$99.99
<b>2311</b>	#4, 4.2 MM	\$99.99



**P9/PA6 2258 \$74.99**



**8D 2259 \$74.99**



**9H Howard 2260 \$74.99**



**15 Freer 2262 \$74.99**  
Curved



**20 Hirschfield 2263 \$74.99**



**#149 2265 \$74.99**



**Benque 2266 \$74.99**

**1 Woodson**      **2268**      **\$74.99**



**#1 Kramer Nevins**      **2271**      **\$74.99**



**#152 Kramer Nevins**      **2272**      **\$74.99**



**Buser**      **2275**      **\$74.99**



**Allen Anterior**      **2276**      **\$74.99**



**Allen**      **2277**      **\$74.99**



**9 Molt Title**      **1633**      **\$74.99**  
**1634**      **\$74.99**

This product is 4.3 mm on one side & 8.4 mm on other



**16 Freer Strongly Curved**      **2348**      **\$74.99**



**1 Hopkins**      **1635**      **\$74.99**



**2 Hopkins**      **1636**      **\$74.99**



**3 Mead**      **1637**      **\$74.99**



**5 Molt**      **1638**      **\$74.99**



**12S Bennett**      **1639**      **\$74.99**



**14 Goldman Fox**      **1640**      **\$74.99**



**23 Seldin**      **1641**      **\$74.99**





**24G**      **1642**      **\$74.99**

Periosteal with one round blade & other flat angled sharp blade. This product is 4.0mm on one side



**3 Prichard**      **1643**      **\$74.99**

Featuring two blades, one large flat blade & one narrow sharp blade on round tip. This product is 4.7mm wide on one side & 11mm on other side



**3/9A**      **1644**      **\$74.99**

Featuring two blades, one large flat blade & one narrow sharp blade on round tip. This product is 4.7mm wide on one side & 11mm on other side



**9A Allen**      **2349**      **\$74.99**

Featuring two blades, one large flat blade & one narrow sharp blade on round tip. This product is 4.7mm wide on one side & 11mm on other side

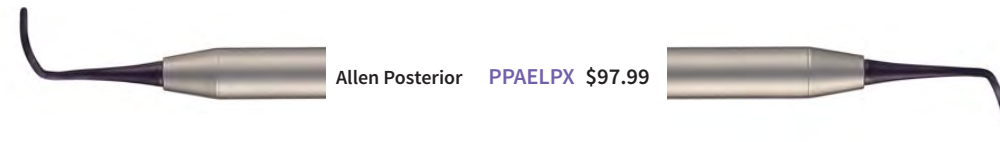

**Allen Posterior**      **PPAELPX**      **\$97.99**

**Allen Posterior**      **PPAELP**      **\$74.99**

Featuring two blades, one large flat blade & one narrow sharp blade on round tip. This product is 4.7mm wide on one side & 11mm on other side



**9 Molt**      **1633S**      **\$97.99**



**3 Prichard**      **1643S**      **\$97.99**



**Allen**      **2277S**      **\$97.99**



**Buser**      **2275S**      **\$97.99**



**Title**      **2272S**      **\$97.99**



**24G**      **1642S**      **\$97.99**

**14 Goldman Fox**      **1640S**      **\$97.99**

**1 Woodson**      **2268S**      **\$97.99**

**1 Posterior**

<b>2337</b>	Regular	\$74.99
<b>PT1S</b>	Siyah	\$97.99
<b>PT1SS</b>	Serrated	\$109.99



**2 Anterior**

<b>2338</b>	Regular	\$74.99
<b>PT2S</b>	Siyah	\$97.99
<b>PT2SS</b>	Serrated	\$109.99



**3 Posterior Right**

<b>2339</b>	Regular	\$74.99
<b>PT3S</b>	Siyah	\$97.99
<b>PT3SS</b>	Serrated	\$109.99



**4 Posterior Left**

<b>2340</b>	Regular	\$74.99
<b>PT4S</b>	Siyah	\$97.99
<b>PT4SS</b>	Serrated	\$109.99



**5 Anterior Angled**

<b>2341</b>	Regular	\$74.99
<b>PT5S</b>	Siyah	\$97.99
<b>PT5SS</b>	Serrated	\$109.99



**6 Anterior Straight**

<b>2342</b>	Regular	\$74.99
<b>PT6S</b>	Siyah	\$97.99
<b>PT6SS</b>	Serrated	\$109.99



**1 Austin Retractor**

<b>200-103 left</b>	\$88.99
<b>200-104 right</b>	\$88.99



**Bishop Cheek Retractor**

**1366** | 13 CM | \$38.99



**University of Minnesota Cheek Retractor**

**1367** | 14 CM | \$38.99



**Cawood Minnesota**

**1368** | 14 CM | \$38.99



**Columbia Cheek Retractor**

**1369** | 14 CM | \$38.99



**Weider Tongue Retractor**

<b>1374</b>   Small	\$86.99
<b>1375</b>   Large	\$86.99



**Farabeuf, Set of 2**

**200-101** | \$73.99



**Orringer, Hands Free**

<b>CROS small</b>	\$49.99
<b>CROM medium</b>	\$49.99
<b>CROL large</b>	\$49.99





**Langenbeck, 23 CM**  
 11-3136-03 | 30x16MM | \$109.99

**Implant Retractor**  
 IMPLR | 23 CM | \$154.99

**Middeldorpf Retractor**  
 MIDLS | 17 x 14 mm | \$109.99  
 MIDLM | 22 x 20 mm | \$109.99

**Surgical Retractor, Curved Down**  
 SR1 | 7x25 MM | \$109.99  
 SR2 | 10x42 MM | \$109.99  
 SR3 | 12x55 MM | \$109.99  
 SR8 | 80x16 MM curved up | \$109.99



**Ramus Retractor, V Notch, Curved Down**  
 SR9 | 70 x 11 mm | \$109.99

**Henahan**  
 1370 | 10 MM | \$79.99  
 1371 | 12 MM | \$79.99  
 1372 | 15 MM | \$79.99

**Molt Mouth Gag**  
 1381 | Large | \$124.99  
 1382 | Medium | \$124.99  
 1383 | Small | \$124.99

**Desmarres Chalazion**  
 17-7838-01 | small | \$64.99  
 17-7838-02 | medium | \$64.99

**Channel Retractor**  
 21-11194-08 | 16cm | \$79.99

- 1 Heidbrink  
1587 | \$74.99

---

- 2 Heidbrink  
1588 | \$74.99

---

- 3 Heidbrink  
1589 | \$74.99

---

- 4 Heidbrink  
2239 | \$74.99

---

- 5 Heidbrink  
2240 | \$74.99



13/14 Heidbrink

2241 | \$74.99

1 Howard

2245 | \$74.99

2 Howard

2246 | \$74.99

4 Howard

2248 | \$74.99

5 Howard

2249 | \$74.99

2/3 Howard

2250 | \$74.99

#3 Scalpel Handle

1385 | \$23.99

1384 | \$21.99

PUSH Scalpel Handle

AS9217 | \$129.99

#5 Round Scalpel Handles

1389 | Straight | \$39.99

1390 | Curved | \$44.99

1391 | Double Blade | \$69.99

1X Miller Colburn 2282 \$94.99

The 1X Miller-Colburn cross-cut bone file is used for final smoothing & shaping of bone with 8.1 mm & 4.8 mm wide working ends

2X Miller Colburn 2283 \$94.99

The 2X Miller-Colburn cross-cut bone file is used for final smoothing & shaping of bone with 6.2 mm wide working ends

3X Miller Colburn 2284 \$94.99

The 3X Miller-Colburn cross-cut bone file is used for final smoothing & shaping of bone with 6.2 mm & 4.8 mm working ends

12A Miller 1653 \$94.99

The 3X Miller-Colburn cross-cut bone file is used for final smoothing & shaping of bone with 6.2 mm & 4.8 mm working ends





**21 Miller**      **2280**    **\$94.99**

8.1 mm & 4.8 mm working ends



**67 Howard**      **1649**    **\$94.99**

with 4.8mm wide, angled working ends



**45 Miller**      **1650**    **\$94.99**

The 45 Miller straight-cut bone file used for final smoothing & shaping of bone with 6.2mm wide working ends



**52 Miller**      **1651**    **\$94.99**

The 67 Miller straight-cut bone file used for final smoothing & shaping of bone with 4.8mm wide, angled working ends



**12 Howard**      **1652**    **\$94.99**

The 12 Howard straight-cut bone file is used for final smoothing & shaping of bone with 8.1mm wide working ends



**64 Miller**      **1654**    **\$94.99**

The 64 Miller straight-cut bone file used for final smoothing & shaping of bone with 6.2 mm & 4.8mm wide working ends



**1 Wahl**      **1655**    **\$94.99**

The 1W Wahl straight-cut bone file is used for final smoothing & shaping of bone with 8.1mm wide working ends



**2 Wahl**      **1656**    **\$94.99**

The 64 Miller straight-cut bone file used for final smoothing & shaping of bone with 6.2 mm & 4.8mm wide working ends



**84 Lucas, 2MM**

- 1624** | Regular | **\$74.99**
- 1624S** | Siyah | **\$97.99**
- 1624SS** | Serrated | **\$99.99**



**85 Lucas, 2.5MM**

- 1625** | Regular | **\$74.99**
- 1625S** | Siyah | **\$97.99**
- 1625SS** | Serrated | **\$99.99**



**86 Lucas, 2.8MM**

- 1626** | Regular | **\$74.99**
- 1626S** | Siyah | **\$97.99**
- 1626SS** | Serrated | **\$99.99**



**87 Lucas, 3.5 MM**

- 1627** | Regular | **\$74.99**
- 1627S** | Siyah | **\$97.99**
- 1627SS** | Serrated | **\$99.99**

88 Lucas, 4.7MM  
 1628 | Regular | \$74.99  
 1628S | Siyah | \$97.99  
 1628SS | Serrated | \$99.99

2/4 Molt, 3.5/7 MM  
 2251 | Regular | \$74.99  
 2251S | Siyah | \$97.99

1 Ochsenbein  
 1253 | \$84.99

2 Ochsenbein  
 1254 | \$84.99

3 Ochsenbein  
 1255 | \$74.99

4 Ochsenbein  
 1256 | \$74.99

1 Fedi  
 1259 | \$74.99

2 Fedi  
 1260 | \$74.99

3 Fedi  
 1261 | \$74.99

4 Fedi  
 2172 | \$149.99

36/37 Rhodes  
 1258 | \$74.99

1/2 Siyah Buser Modified 2173S \$97.99  
 4 mm/5 mm

2/3 Siyah Buser Modified 2174S \$97.99  
 5 mm/6 mm

1/3 Siyah Buser Modified 2175S \$97.99  
 4 mm/6 mm



	#1 Siyah Tunneling	TKN1	\$97.99
	#2 Siyah Tunneling	TKN2	\$97.99
	1/2 Siyah Orban	2168S	\$97.99
	15/16 Siyah Kirkland	1241S	\$97.99
	11 Siyah Goldman Fox	1246S	\$97.99
	1/2 Siyah Allen Modified Orban Knife	AMOK1/2	\$97.99
	Allen End Cutting Siyah Intrасucular Knife	SPKA	\$97.99
	Siyah Allen Arrow-head Knife	AAHK	\$97.99
	3/4 Buck	1247	\$58.99
	5/6 Buck	1248	\$58.99
	7 Goldman Fox	1242	\$58.99
	8 Goldman Fox	1243	\$58.99

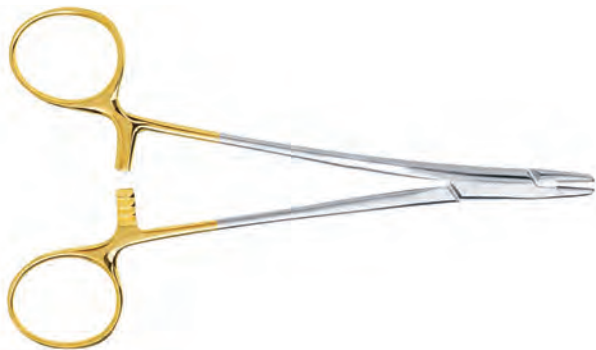

Wire Twister, TC Tips	13-3892-18	\$149.99
18 CM		
Wire Twister, TC Tips	13-3892-16	\$149.99
16 CM		

BONE CHISELS

1 Gardner Single Bevel	2285	\$94.99
3mm		
2 Gardner Single Bevel	2286	\$94.99
4mm		
1 Chandler	2290	\$94.99
5 MM, Single Bevel		
2 Chandler	2291	\$94.99
5 MM, Single Bevel		
1W Wakefield	2299	\$94.99
Bi-Bevel		
2W Wakefield	2300	\$94.99
Bi-Bevel		
4 Buser, 4MM	1647	\$74.99
6 Buser, 6MM	1648	\$74.99



SYRINGES

Type A Aspirating Anesthetic Syringe	1399	\$64.99
Self Aspirating Syringe	1399SA	\$64.99
Type CW Aspirating Anesthetic Syringe	1400	\$64.99





College **1157** \$19.99



Meriam **1158** \$19.99



College, Locking **1160** \$24.99



Perry **1162** \$19.99  
4mm



#17 College, Heavy Duty **DP17** \$34.99



#18 Meriam, Heavy Duty **DP18** \$34.99



Signature Mirror Handle **1168** \$21.99



Signature Mirror Handle, Siyah **1168S** \$29.99



#4 Mirrors, Cone  
22MM, Pack of 12  
**1169** | \$47.99



#5 Mirrors, Cone  
24MM, Pack of 12  
**1170** | \$47.99



#4 Double Sided Mirrors, Cone  
22MM  
**1171** | \$47.99



#5 Double Sided Mirrors, Cone  
24MM  
**1172** | \$47.99



#5 Mirror, Cone, Siyah  
22MM  
**SMC5** | \$14.99



#5 Double Mirror, Cone, Siyah  
24MM  
**SMDC5** | \$14.99

2 Siyah Explorer **1112s** \$39.99



3CH Siyah Cow-horn Explorer **1114s** \$39.99



5 Siyah Explorer **1115s** \$39.99



TU17/23 Siyah Explorer **1116s** \$39.99



23/CP 12 Siyah Expro **1150s** \$39.99



ODU 11/12 Siyah Explorer **1122s** \$39.99

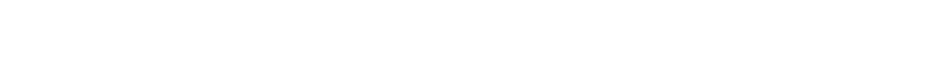

1 Explorer **1111** \$29.99



2 Explorer **1112** \$29.99



2A Pigtail Explorer **2210** \$29.99



2H Explorer **2211** \$29.99



2R/2L Explorer **2212** \$29.99



3ES Explorer **2213** \$29.99



3A/TU17 Explorer **2214** \$29.99



3 Explorer **1113** \$29.99



3CH Explorer **1114** \$29.99



5 (17/23) Explorer **1115** \$29.99





**TU17/23 Explorer 1116 \$29.99**

Combination of #TU17 end for subgingival calculus detection and #23 end for caries detection; the #TU17 end features a balanced tip design for ease and comfort

**6/3 Explorer 1117 \$29.99**

Combination of #TU17 end for subgingival calculus detection and #23 end for caries detection; the #TU17 end features a balanced tip design for ease and comfort

**23/6 Explorer 1118 \$29.99**

Ideal for posterior calculus detection in deep pockets, especially on proximal surfaces. Designed to explore an entire dentition with a single instrument

**2 Explorer 1122 \$29.99**

Ideal for posterior calculus detection in deep pockets, especially on proximal surfaces. Designed to explore an entire dentition with a single instrument

**ODU 11/12 Elongated Explorer 1122AF \$29.99**

Ideal for posterior calculus detection in deep pockets, especially on proximal surfaces. Designed to explore an entire dentition with a single instrument

**EN1 Explorer EN1 \$29.99**

Ideal for posterior calculus detection in deep pockets, especially on proximal surfaces. Designed to explore an entire dentition with a single instrument

**23/QW Williams 1146 \$29.99**

[1-2-3-5-7-8-9-10]

**23/CP8 Expro 1147 \$29.99**

[3-6-8-11]

**23/CP11 Expro 1148 \$29.99**

[3-6-8-11]

**23/CP11.5Ball Expro 1149 \$29.99**

[3.5-5.5-8.5-11 Ball]

**23/CP12 Expro 1150 \$29.99**

[3-6-9-12]

**23/UNC15 Expro 1151 \$29.99**

[1-2-3-4-5-6-7-8-9- 10-11-12-13-14-15]

**23/UNC12 Expro 2223 \$29.99**

[1-2-3-4-5-6-7-8-9- 10-11-12]

**CPNT3/CP12 Expro 2224 \$29.99**

[1-2-3-5-7-8-9-10]

**TU17/UNC15 Expro 1152 \$29.99**

[1-2-3-4-5-6-7-8-9- 10-11-12-13-14-15]

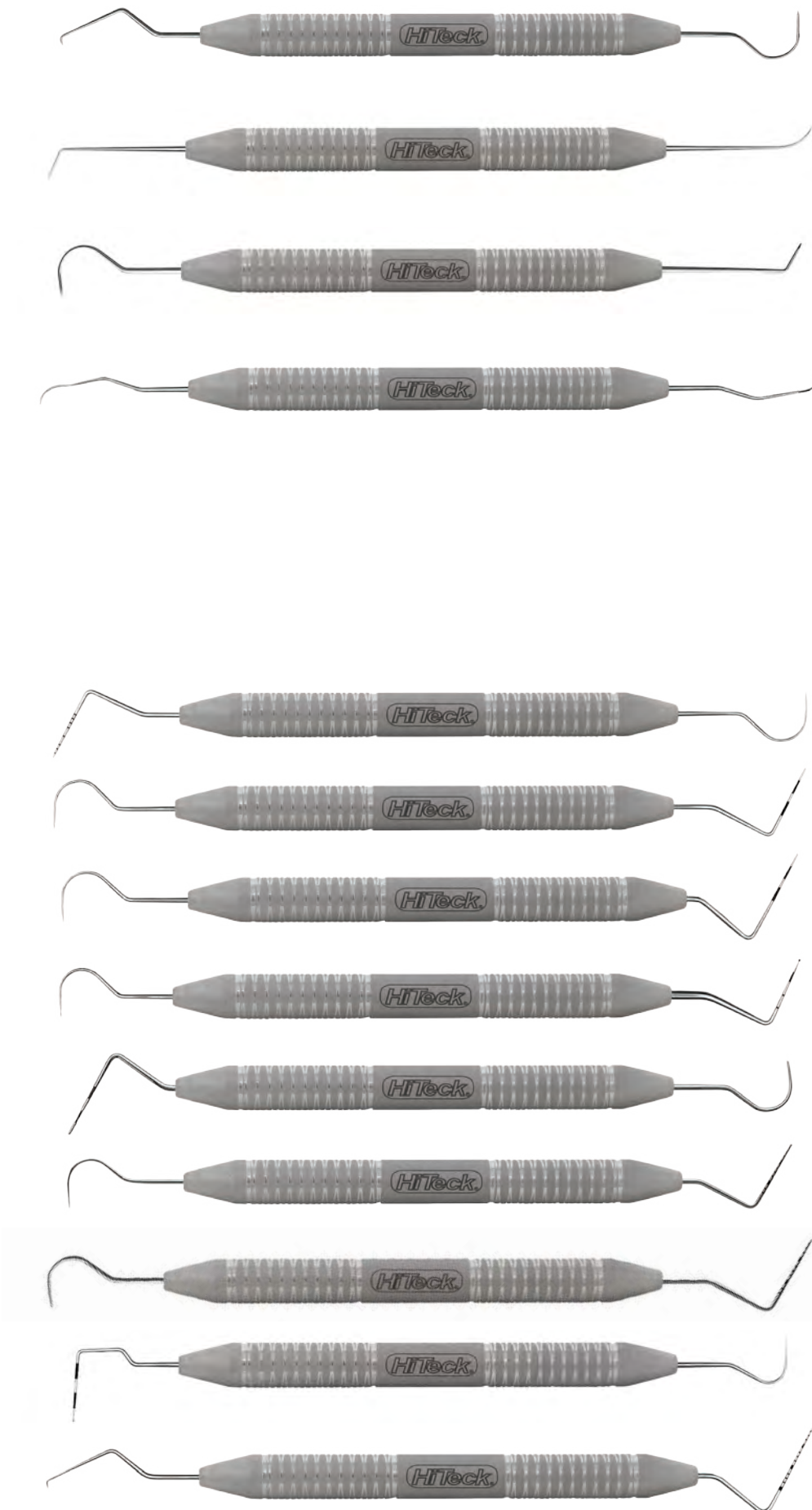



[1-2-3-5-7-8-9-10]



**Meritt B Probe** **2216** \$29.99

[1-2-3-5-7-8-9-10]



**Williams CPN Probe** **2217** \$29.99

[3-6-8-11]



**CP 11 CPN Probe** **2218** \$29.99

[3-6-9-12]



**CP 12 CPN Probe** **2219** \$29.99

[1-2-3-4-5-6-7-8-9-10-11-12]



**CP 12 UNC Probe** **2220** \$29.99

[1-2-3-4-5-6-7-8-9-10-11-12-13-14-15]



**UNC 15 CPN Probe** **2221** \$29.99

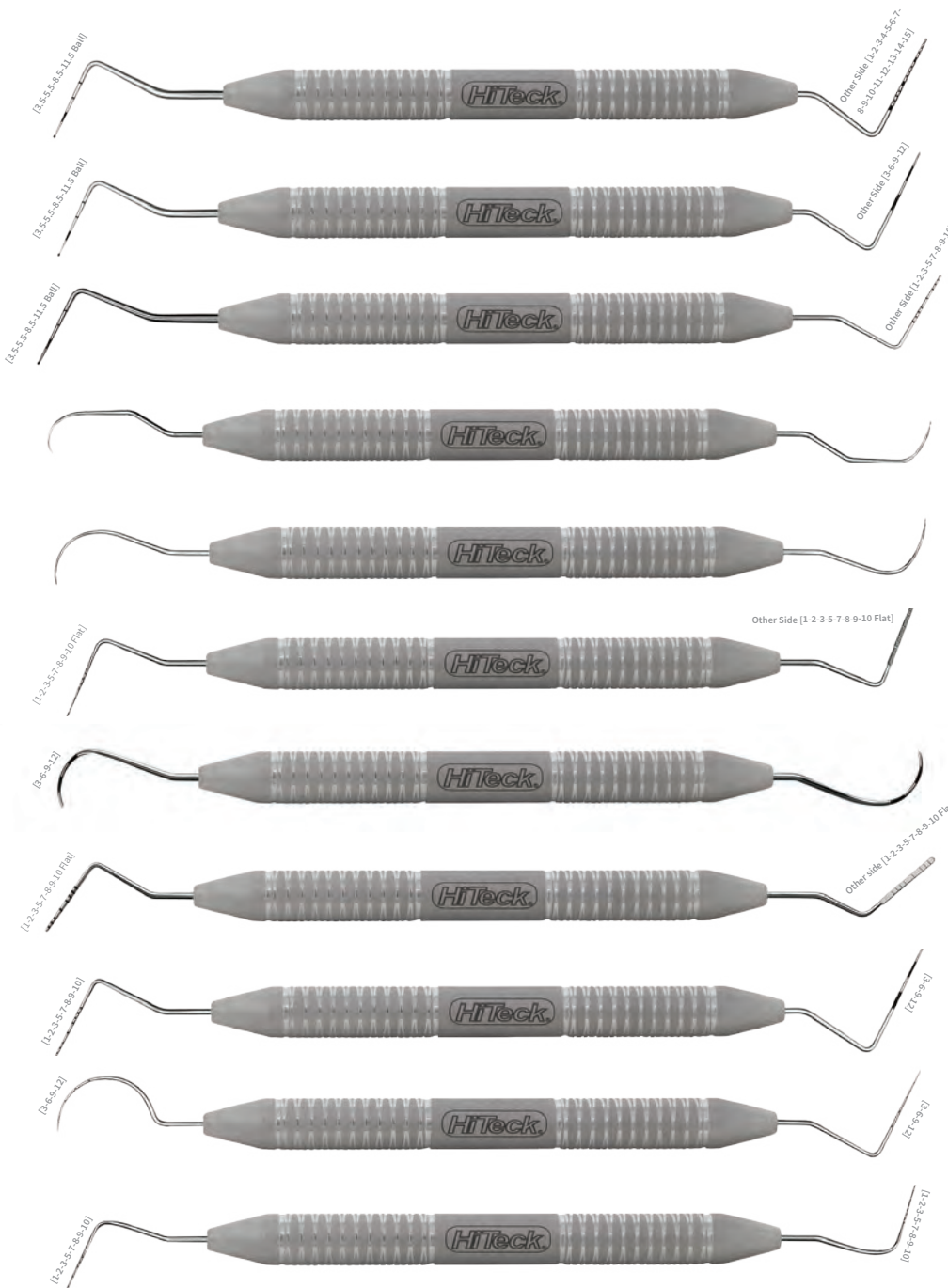

**UNC15/11.5B Probe** **1137** \$29.99

**CP12/11.5B Probe** **1138** \$29.99

**PQW/11.5B Probe** **1139** \$29.99

**1N Nabers Probe** **1140** \$29.99

**2N Nabers Probe** **1141** \$29.99

**3N Nabers Probe** **2222** \$29.99

**Q2N Nabers Probe** **1142** \$29.99

**GF/Williams Probe** **1143** \$29.99

**CP12/Williams Probe** **1144** \$29.99

**UT3/4 Cattoni Probe** **1145** \$29.99

**Williams Williams Offset Probe** **2410** \$29.99

H6/H7 Hygienist **1175** \$34.99



H5/J33 Jacquette **1176** \$34.99



H5/U15 Hygienist **2101** \$34.99



6/7 Goldman **2102** \$34.99

Shortened version of the H6/H7 Scaler.



U15/J30 Towner Jacquette **1177** \$34.99



U15/J33 Towner Jacquette **1178** \$34.99



204 Sickle **1183** \$34.99



204 IUFW **2105** \$34.99



204S Scaler **1184** \$34.99



204SD Scaler **1185** \$34.99

Posterior



3/4 Remington **2109** \$34.99

Distal



137 Anterior Sickle **2111** \$34.99

Anterior Sickle/Anterior Universal Curette Combo.



135 Sickle **1187** \$34.99



30/33 Jacquette **1180** \$29.99

Standard/Miniature Anterior Jacquette.



31/32 Jacquette **1181** \$29.99

Posterior standard jacquette



34/35 Jacquette Scaler **1182** \$29.99

Posterior miniature Jacquette



# PERIODONTAL



H3/H4 Jacquette	2103	\$34.99
14/15 Posterior Jacquette	2104	\$34.99
14/15 Posterior	1191	\$34.99
11A/12A McCall	2126	\$34.99
11/12S McCall	2127	\$34.99
13S/14S McCall	1192	\$34.99
17S/18S McCall	1195	\$34.99
19/20 McCall	1196	\$34.99
GF1 Goldman Fox	1197	\$34.99
GF2 Goldman Fox	1198	\$34.99
GF3 Goldman Fox	1199	\$34.99
GF4 Goldman Fox	1200	\$34.99
GF5 Goldman Fox	1201	\$34.99
GF6 Goldman Fox	1202	\$34.99
For mesial/distal surfaces of the posterior teeth		
GF21 Goldman Fox	1203	\$34.99
GF21S/33 Goldman Fox	2128	\$34.99

**1/2 Langer**      **1204**    \$34.99

For mandibular posterior



**3/4 Langer**      **1205**    \$34.99



**5/6 Langer**      **1206**    \$34.99



**17/18 Langer**    **1207**    \$34.99



**13/14 Indiana**    **1208**    \$34.99

Anterior



**17/18 Indiana**    **1209**    \$34.99

Posterior



**1/2 Bunting**      **1210**    \$34.99

Curette Chisel Combination



**5/6 Bunting**      **1211**    \$34.99



**7/8 Younger Good** **1212**    \$34.99



**1/2 Barnhart**     **1213**    \$34.99



**5/6 Barnhart**     **1214**    \$34.99



**2R/2L Columbia** **1215**    \$34.99



**4R/4L Columbia** **1216**    \$34.99

Posterior application



**13/14 Columbia** **1217**    \$34.99

Universal application



**3/4 Rule**          **1218**    \$34.99



# PERIODONTAL

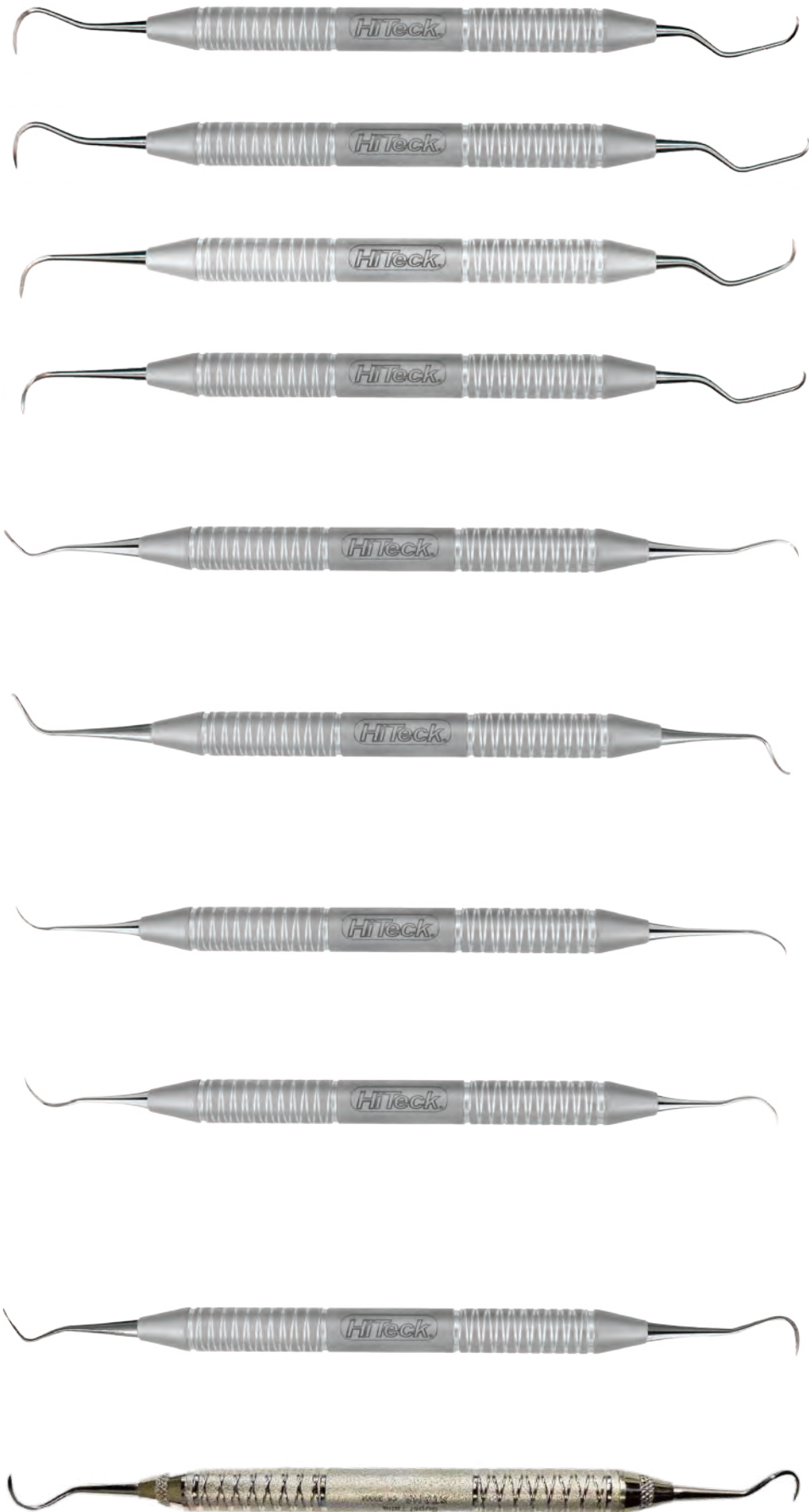

**H5 Langer 5**     **H5L5**     **\$34.99**

2-in-1 anterior instrument with an H5 straight sickle scaler on one end for deposit removal and interproximal access

**H5 Langer 5 Mini**     **H5L5M**     **\$29.99**

Features a mini Langer version of the H5-L5

**Nebraska 128/ Langer 5**     **N128L5**     **\$34.99**

2 in 1 anterior instrument with a Nebraska 128 on one end for narrow, interproximal access

**Nebraska 128 Langer 5 Mini**     **N128L5M**     **\$34.99**

**TAHA 1 Anterior**     **TAHA1**     **\$34.99**

An elongated disc end for anterior lingual stain and calculus removal. Paired with a super thin, anterior curved sickle.

**TAHA 2 Posterior**     **TAHA2**     **\$34.99**

A super thin posterior curved sickle scaler with a contra-angle design for better interproximal reach and ergonomic hand positioning. Ideal for light to moderate interproximal calculus removal.

**TAHA 3 Posterior**     **TAHA3**     **\$34.99**

This ultra thin, dual cutting blade proves effective for reaching tight, narrow contacts and inter-proximal areas. Ideal for effective removal of light to moderate calculus in tight, narrow posterior inter-proximal.

**TAHA 4 Posterior**     **TAHA4**     **\$34.99**  
**TAHA4S**     **\$34.99**

Tapered dual cutting blades provide precise access for effective deposit removal and increased shank rigidity provides for effective removal of burnished heavy and tenacious deposits. Ideal for scaling heavy posterior inter-proximal deposits. Largest blade in the TAHA collection.

**Taha 1/H5 Anterior**     **TAHA1H5**     **\$34.99**

An elongated disc end for anterior lingual stain and calculus removal paired with a larger H5 sickle - a thin curved blade for interproximal and cervical anterior areas.

**Super Taha (Montana Jack)**     **STAHA**     **\$34.99**

Equivalent to R138 (Montana Jack) scaler.

# PERIODONTAL

**1/2 Gracey**      **1229** \$34.99  
**1/2 Rigid Gracey**      **G12R** \$34.99

Slight contra-angle for anterior incisors and canines



**3/4 Gracey**      **1230** \$34.99  
**3/4 Rigid Gracey**      **G34R** \$34.99

Short contra-angle for anterior incisors and canines



**5/6 Gracey**      **1231** \$34.99  
**5/6 Rigid Gracey**      **G56R** \$34.99

Medium contra-angle for anteriors and premolars



**7/8 Gracey**      **1232** \$34.99  
**7/8 Rigid Gracey**      **G78R** \$34.99

Medium contra-angle for premolars and molar facial and lingual surfaces



**9/10 Gracey**      **1233** \$34.99  
**9/10 Rigid Gracey**      **G910R** \$34.99

Long contra-angle for molar buccal and lingual surfaces and a more pronounced angle than 7/8 for less accessible root surfaces



**11/12 Gracey**      **1234** \$34.99  
**11/12 Rigid Gracey**      **G1112R** \$34.99

Angulated to reach mesial surfaces of posterior teeth



**13/14 Gracey**      **1235** \$34.99  
**13/14 Rigid Gracey**      **G1314R** \$34.99

Angulated to reach distal surfaces of posterior teeth



**15/16 Gracey**      **1236** \$34.99  
**15/16 Rigid Gracey**      **G1516R** \$34.99

Same shank bends as 13/14, but blade positioned to reach mesial posterior surfaces



**17/18 Gracey**      **1237** \$34.99  
**17/18 Rigid Gracey**      **G1718R** \$34.99

Accentuated angles improve access to distal posterior surfaces. The 17/18 also has smaller blade and slightly longer terminal shank



**11/14 Gracey**      **2143** \$34.99  
**11/14 Rigid Gracey**      **G1114R** \$34.99



**12/13 Gracey**      **2144** \$34.99  
**12/13 Rigid Gracey**      **G1213R** \$34.99







1/2 Mini Gracey 1220 \$34.99  
 1/2 Mini Rigid Gracey G12MR \$34.99  
 1/2 Micro Mini Gracey 1/2MMG \$34.99

Mini version of 1/2 Gracey



3/4 Mini Gracey 1221 \$34.99  
 3/4 Mini Rigid Gracey G34MR \$34.99

Mini Version of 3/4 Gracey



5/6 Mini Gracey 1222 \$34.99  
 5/6 Mini Rigid Gracey G56MR \$34.99

Mini Version of 5/6 Gracey



7/8 Mini Gracey 1223 \$34.99  
 7/8 Micro Mini Gracey 7/8MMG \$34.99  
 7/8 Mini Rigid Gracey G78MR \$34.99

Mini Version of 7/8 Gracey



9/10 Mini Gracey 1224 \$34.99  
 9/10 Mini Rigid Gracey G910MR \$34.99

Mini Version of 9/10 Gracey



11/12 Mini Gracey 1225 \$34.99  
 11/12 Micro Mini Gracey 1112MMG \$34.99  
 11/12 Mini Rigid Gracey G1112R \$34.99

Mini Version of 11/12 Gracey



13/14 Mini Gracey 1226 \$34.99  
 13/14 Micro Mini Gracey 1314MMG \$34.99  
 13/14 Mini Rigid Gracey G1314MR \$34.99

Mini version of 13/14 Gracey



15/16 Mini Gracey 1227 \$34.99  
 15/16 Mini Rigid Gracey G1516MR \$34.99

Mini version of 15/16 Gracey



17/18 Mini Gracey 1228 \$34.99  
 17/18 Mini Rigid Gracey G1718MR \$34.99

Mini Version of 17/18 Gracey



11/14 Mini Gracey G114M \$34.99  
 11/14 Mini Rigid Gracey G114MR \$34.99



12/13 Mini Gracey G1213M \$34.99  
 12/13 Mini Rigid Gracey G1213MR \$34.99

# PERIODONTAL

1/2 Arhum Gracey **AG12** \$34.99  
 1/2 Arhum Rigid **AG12R** \$34.99  
 Gracey

Slight contra-angle for anterior incisors and canines



3/4 Arhum Gracey **AG34** \$34.99  
 1/2 Arhum Rigid **AG34R** \$34.99  
 Gracey

Short contra-angle for anterior incisors and canines



5/6 Arhum Gracey **AG56** \$34.99  
 5/6 Arhum Rigid **AG56R** \$34.99  
 Gracey

Medium contra-angle for anteriors and premolars



7/8 Arhum Gracey **AG78** \$34.99  
 7/8 Arhum Rigid **AG78R** \$34.99  
 Gracey

Medium contra-angle for premolars and molar facial and lingual surfaces



11/12 Arhum **AG1112** \$34.99  
 Gracey

11/12 Arhum Rigid **AG1112R** \$34.99  
 Gracey

Medium contra-angle for premolars and molar facial and lingual surfaces



13/14 Arhum **AG1314** \$34.99  
 Gracey

13/14 Arhum Rigid **AG1314R** \$34.99  
 Gracey

Angulated to reach mesial surfaces of posterior teeth



15/16 Arhum **AG1516** \$34.99  
 Gracey

15/16 Arhum Rigid **AG1516R** \$34.99  
 Gracey

Angulated to reach distal surfaces of posterior teeth



17/18 Arhum **AG1718** \$34.99  
 Gracey

17/18 Arhum Rigid **AG1718R** \$34.99  
 Gracey

Angulated to reach distal surfaces of posterior teeth



11/14 Arhum **AG1114** \$34.99  
 Gracey

11/14 Arhum Rigid **AG1114R** \$34.99  
 Gracey

Accentuated angles improve access to distal posterior surfaces. The 17/18 also has smaller blade and slightly longer terminal shank



12/13 Arhum **AG1213** \$34.99  
 Gracey

12/13 Arhum Rigid **AG1213R** \$34.99  
 Gracey



# ENDODONTIC

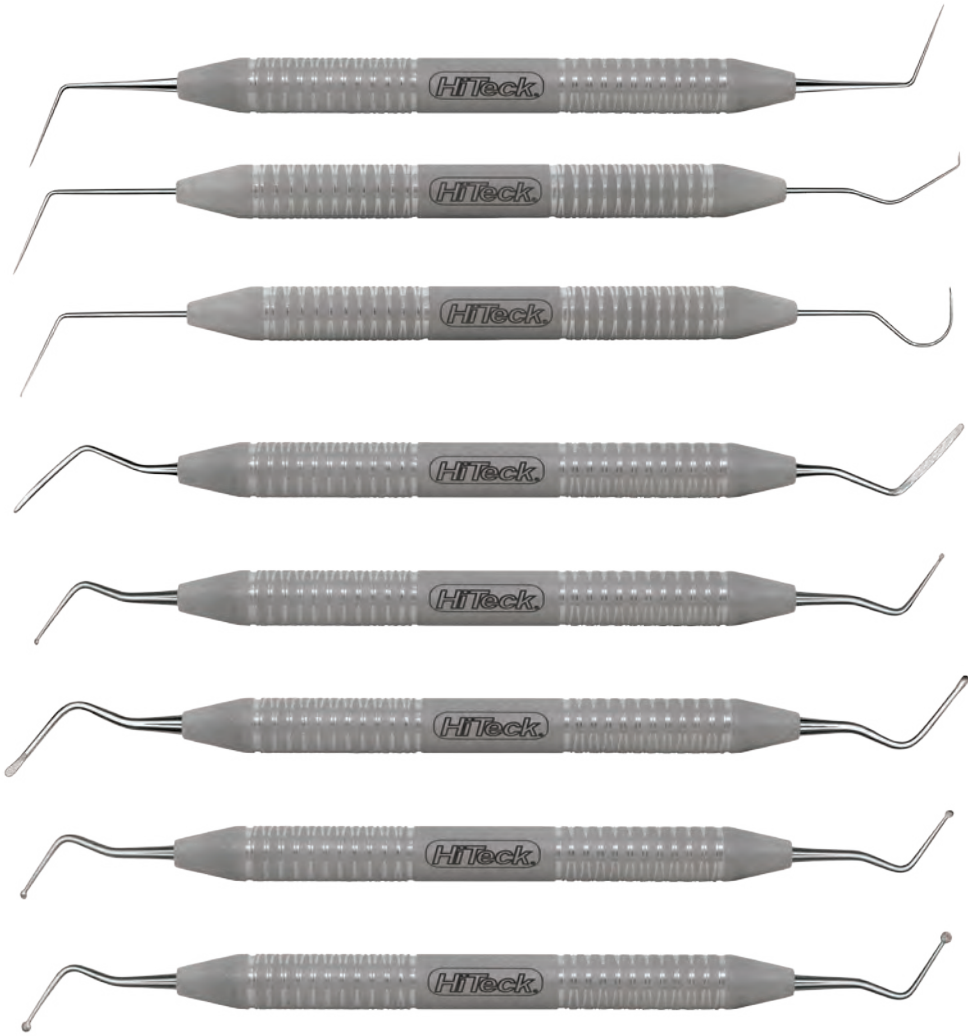

DG 16 Explorer **1119** \$29.99

DG 16/17 Explorer **1120** \$29.99

DG 16/23 Explorer **1121** \$29.99

2 Glick **2405** \$34.99

31L Spoon **2406** \$34.99

31W Oval Spoon **2407** \$34.99

32L Spoon **2408** \$34.99

33L Spoon **2409** \$34.99

8A 29mm • 0.40mm **1270** \$32.99

9A 29mm • 0.55mm **1271** \$32.99

10A 29mm • 0.75mm **1272** \$32.99

11A 29mm • 1.05mm **1273** \$32.99

8.5A 29mm • 0.45mm **1274** \$32.99

9.5A 29mm • 0.65mm **1275** \$32.99

10.5A 29mm • 0.90mm **1276** \$32.99

11.5A 29mm • 1.15mm **1277** \$32.99

12A 29mm • 1.30mm **1278** \$32.99



Stainless Steel **ERULE6** \$28.99  
Ruler

6 Inches

Rubber Dam **RDCOB8** \$59.99  
Clamp  
Organizing  
Board

Store, sterilize and organize with eight  
pegs that securely hold your clamps.  
Dimensions: 4.62" x 2.4" x .375"  
(117 mm x 61 mm x 10 mm). 8 Pieces.



8 22mm	• 0.40mm	1279	\$32.99
9 22mm	• 0.55mm	1280	\$32.99
10 22mm	• 0.75mm	1281	\$32.99
11 22mm	• 1.05mm	1282	\$32.99
8.5 22mm	• 0.45mm	1283	\$32.99
9.5 22mm	• 0.65mm	1284	\$32.99
10.5 22mm	• 0.90mm	1285	\$32.99
11.5 22mm	• 1.15mm	1286	\$32.99
12 22mm	• 1.30mm	1287	\$32.99



Stieglitz 1295 \$57.99



Stieglitz Curved 1296 \$59.99











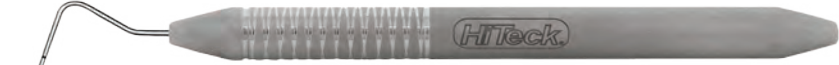

Stieglitz Angled 1297 \$59.99



Peet Curved 1298 \$49.99

# ENDODONTIC

	ISO Size 30 (24MM/0.3MM)	1262	\$32.99
	ISO Size 40 (24MM/0.4MM)	1263	\$32.99
	ISO Size 50 (24MM/0.5MM)	1264	\$32.99
	ISO Size 60 (24mm)	1265	\$32.99
	1/3 Root Canal Plugger (21mm) 0.4MM/0.45MM	2257	\$32.99
	5/7 Root Canal Plugger (21mm) 0.5MM/0.75MM	2351	\$32.99
	9/11 Root Canal Plugger (21mm) 1.0MM/1.15MM	2352	\$32.99
	L1 18mm (0.45 MM)	1266	\$32.99
	L2 18mm (0.5 MM)	1267	\$32.99
	L3 18mm (0.75 MM)	1268	\$32.99
	L4 18mm (1.00 MM)	1269	\$32.99

RUBBER DAM FORCEPS



Ivory Lightweight  
17cm  
1299 | \$78.99



Brewer  
17cm  
1300 | \$87.99



U of Washington  
17cm  
1301 | \$87.99



Title  
17cm  
CS11 | \$109.99

RUBBER DAM PUNCH

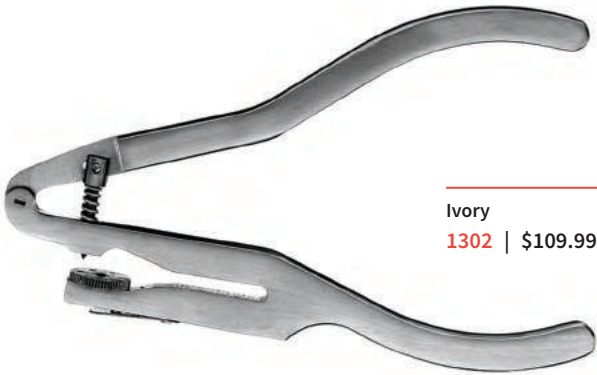

Ivory  
1302 | \$109.99



Ainsworth  
1303 | \$109.99

RUBBER DAM FRAMES



Small Child  
3.5 inch/9cm  
1304 | \$29.99

Child  
5 inch/13cm  
1305 | \$29.99

Adult  
6 inch/15cm  
1306 | \$29.99



**0**  
Flat jaws and high bow for small lower canines and first premolars  
**1307 | \$13.75**



**6**  
Slightly offset jaws for labial caries on anterior teeth  
**1317 | \$13.75**



**9**  
Offset flat jaws and stiff bow for anterior teeth  
**1322 | \$13.75**



**9S**  
Offset flat serrated jaws for anterior teeth  
**1323 | \$13.75**



**212**  
Flat jaws for labial caries on anterior teeth  
**1345 | \$13.75**



**212SA**  
Slightly offset staggered jaws for odd shaped anteriors  
**1346 | \$13.75**



**3**  
Flat narrow jaws for small lower molars  
**1314 | \$13.75**



**7**  
Flat jaws for lower molars  
**1318 | \$13.75**



**7A**  
Slightly reversed festooned jaws for large lower molars  
**1319 | \$13.75**



**12A**  
Serrated offset jaws for lower right molars; paired with RDCM13A  
**1326 | \$13.75**



**13A**  
Serrated offset jaws for lower left molars; paired with RCM12A  
**1327 | \$13.75**



**26**  
Slightly reversed festooned jaws for small lower molars  
**1333 | \$13.75**



**28**  
Flat jaws for lower molars  
**1337 | \$13.75**



**W3**  
Flat narrow jaws for small lower molars  
**1348 | \$13.75**



**W7**  
Flat jaws for lower molars  
**1350 | \$13.75**



**8A**  
Deeply festooned four-point jaws for molars  
**1321 | \$13.75**



**10**  
Flat jaws designed for small upper left and lower right molars; paired with RDCM11  
**1324 | \$13.75**



**11**  
Flat jaws designed for small upper right and lower left molars; paired with RDCM10  
**1325 | \$13.75**



**14**  
Deeply festooned jaws for partially erupted or irregularly shaped molars  
**1328 | \$13.75**



**14A**  
Deeply festooned jaws for partially erupted or irregularly shaped molars; larger than RDCM14  
**1329 | \$13.75**



**18**  
Flat jaws for upper right and lower left molars; paired with RDCM25  
**1330 | \$13.75**



**24**  
Flat jaws for upper left and lower right molars; paired RDCM24  
**1331 | \$13.75**



**25**  
Flat jaws for large molars  
**1332 | \$13.75**



**27**  
Slightly festooned jaws for large molars  
**1335 | \$13.75**



**56**  
Slightly festooned serrated jaws for large partially erupted or irregularly shaped molars  
**1341** | \$13.75



**56S**  
Slightly festooned jaws for molars  
**1342** | \$13.75



**W8A**  
Deeply festooned jaws for partially erupted or irregularly shaped molars  
**1351** | \$13.75



**W14A**  
Deeply festooned jaws and extended bow for distal access to molars  
**2231** | \$13.75



**8AD**  
Deeply festooned jaws and extended bow for distal access to molars  
**2232** | \$13.75



**0**  
Flat jaws and high bow for longer premolars  
**1308** | \$13.75



**1**  
Slightly festooned jaws for upper premolars  
**1309** | \$13.75



**1A**  
Deeply festooned jaws for canines and premolars  
**1310** | \$13.75



**2**  
Flat jaws for premolars  
**1311** | \$13.75



**2A**  
Flat jaws for larger premolars  
**1312** | \$13.75



**2AS**  
Flat serrated jaws for larger premolars  
**1313** | \$13.75



**27N**  
Slightly festooned jaws for premolars  
**1336** | \$13.75



**29**  
Flat jaws for lower premolars  
**1338** | \$13.75



**W2**  
Flat jaws for premolars  
**1347** | \$13.75



**209**  
Small, flat jaws with stiff bow for lower premolars  
**2233** | \$13.75



**4**  
Flat narrow jaws for small upper molars  
**1315** | \$13.75



**5**  
Slightly festooned jaws for large upper molars  
**1316** | \$13.75



**8**  
Deeply festooned jaws for upper molars  
**1320** | \$13.75



**26N**  
Flat jaws for upper molars  
**1334** | \$13.75



**30**  
Offset jaws for upper right molars; paired with RDCM31  
**1339** | \$13.75



**31**  
Offset jaws for upper left molars; paired with RDCM30  
**1340** | \$13.75



**201**  
Slightly festooned jaws for upper molars  
**1343** | \$13.75



**205**  
Slightly festooned jaws for large upper molars  
**1344** | \$13.75



**W4**  
Flat narrow jaws for small upper molars  
**1349** | \$13.75





**1 Goldstein** 2467 \$42.99

Small universal style with rounded plunger tip and a narrow paddle for initial placement and contouring of Class I, II, and III restorations

**2 Goldstein** 2468 \$42.99

Larger universal style for final placement and contouring of Class I, II, and III restorations.

**3 Goldstein Extra Flex** 2469 \$42.99

Flexible, reversed, flared paddle design for shaping and placement of Class III and IV restorations

**4 Goldstein Extra Flex** 2470 \$42.99

Flexible, paired, offset, paddle-shaped blades for placing and shaping material on posterior, mesial and distal surfaces. Reverse angle is also useful for placing and shaping anterior bonded restorations

**5 Goldstein Flexi Thin** 300-101 \$42.99

Small reverse angle tips make it easy to place fissures, grooves and pits creating the ideal occlusal anatomy in hard to reach posterior areas.

**6 Goldstein Flexi Thin** 300-102 \$42.99

Large reverse angle tips make it easy to place fissures, grooves and pits creating the ideal occlusal anatomy in hard to reach posterior areas

**1 Mini Goldstein** 2473 \$42.99

Mini version of 1 Goldstein for small pits and fissures, tunnel preparations or minor tooth defects on lower anteriors.

**TITLE** 2474 \$42.99

Mini version of 2 Goldstein. Can also be used for packing gingival retraction cord

**3 Mini Goldstein Extra Flex** 2475 \$42.99

Mini version of 2 Goldstein. Can also be used for packing gingival retraction cord

**4 Mini Goldstein Extra Flex** 2476 \$42.99

Mini version of 4 Goldstein for placing and shaping material in difficult to access mesial and distal posterior restorations

**AB1 Bhogosian** 2363 \$42.99

Unique combination of thin, knife-shaped blade with standard angled blade. Knife blade allows controlled, efficient manipulation of composite even in gingival areas. Application: Class III, IV, V

**AB2 Bhogosian** 2364 \$42.99

Used for measuring composite layers and shaping occlusal anatomy

**W3** 2365 \$42.99

Combination of medium-sized blade with small condenser tip for universal adaptability. Ideal for placement, layering and general contouring. Application: Class I, II, III, IV, V

**8A**                    **2366**    **\$42.99**

Use for packing gingival retraction cord, as well as to place and contour facial aspects



**4/5 Gregg**            **2367**    **\$42.99**

Off-angled blades allow easy adaptability to mesial and distal surfaces of posterior teeth, providing increased interproximal access and better visibility of the working area  
Application: Class II, V



**Interproximal Carver**            **2368**    **\$42.99**

Extremely thin flexible blades are opposed for easy handling of composite materials and interproximal contouring.  
Application: Class III, IV, V



**Interproximal Carver, Long**            **2369**    **\$42.99**

Used for placement of the composite increments against the cavity wall or adjacent tooth surface



**A6**                    **2370**    **\$42.99**

Large, thin blades are opposed for adaptability to any situation, including veneers, where broad contouring or carving strokes are needed. Application: Class II, III, IV and V Mini version of 4 Goldstein for placing and shaping material in difficult to access mesial and distal posterior restorations



**Contouring Instrument**            **2371**    **\$42.99**

Used for shaping of inclines, planes or developmental lobes for anterior and posterior restorations. The instrument has different angles of curvature on each end that provides a buccal and lingual orientation for posterior shaping or a facial and lingual orientation for anterior shaping



**1 Loesche**            **1936**    **\$44.99**



**2 Loesche**            **1937**    **\$44.99**



**11 Anterior**            **1938**    **\$42.99**



**179 Anterior**            **1939**    **\$42.99**



**1 Woodson**            **1940**    **\$42.99**



**21B Acorn**            **300-103**    **\$42.99**



**27/29**                    **300-104**    **\$42.99**



# RESTORATIVE



**2 Ladmore**    **300-105**    **\$42.99**

Medium to large rounded tips for condensing composite materials

**3 Ladmore**    **300-106**    **\$42.99**

Small to medium slightly rounded tips for condensing composite materials

**Ball 18**    **300-107**    **\$42.99**

Used to smooth and shape composite

**Freedman Duckhead**    **300-108**    **\$44.99**

Used to contour the convexity of the cusp ridge, developing the anatomy in a single motion

**Freedman Small Contact Forming**    **300-109**    **\$44.99**

Acorn-shaped instrument for forming occlusal anatomy in posterior restorations

**Freedman Large Contact Forming**    **300-110**    **\$44.99**

Oval-shaped paired instrument designed to provide improved contact forming for large Class II Restorations as well as to place and contour facial aspects

**Small/Medium Ball**    **300-132**    **\$44.99**

Used to direct and form the composite increments against the cavity wall. The shape conforms to the rounded cavity surfaces and allows ease of access into the rounded corners or junctions of the cavity surfaces to condense and shape the composite against the cavity wall.

**Small/Medium Contact Forming**    **300-133**    **\$44.99**

Rounded cone-shaped paired instrument designed to provide improved contact forming for small/medium Class II restorations instrument designed to provide improved contact forming for small/medium Class II restorations as well as to place and contour facial aspects

**Medium Large Contact Forming**    **300-134**    **\$44.99**

Rounded cone-shaped instrument to provide improved contact forming for medium/ large Class II restorations

**A Cosmetic Contouring**    **300-111**    **\$44.99**

Identical, opposing, large, flexible, oval shaped blades, straight and angled, for contouring composite material on larger facial surfaces of central incisors.

**B Cosmetic Contouring**    **300-112**    **\$44.99**

Identical, opposing, spear-shaped blades, straight and angled, used for contouring composite material on smaller facial surfaces of central incisors.

**C Cosmetic Contouring**    **300-113**    **\$44.99**

Flexible, oval-shaped blades – one slightly larger – for interproximal contouring on central incisors.

**D Cosmetic Contouring**    300-114    \$44.99

Used when working near or at interproximal areas. Straight end compacts composite material, while sharp knife edge cuts composite to avoid bonding to adjacent tooth.



**E Cosmetic Contouring**    300-115    \$44.99

Small and medium curved blades for thinning and shaping composite material at the gingival areas.



**F Cosmetic Contouring**    300-116    \$44.99

Uniquely-shaped blades with curved and rounded tips for adding and shaping composite material on desired areas of facial incisors.



**G Marginal Ridge & Embrasure Shaping Instrument**    300-117    \$44.99

Allows formation of marginal ridges along with buccal and lingual embrasures while composite is uncured.



**H Occlusal Anatomy Instrument**    300-118    \$44.99

Designed to help attain proper occlusal form, function and improve marginal seal.



**I Composite Packing Instrument**    300-119    \$44.99

Aids in forming a properly filled axial box and occlusal portion.



**14L Composite Carver**    CS10G    \$42.99

Aids in forming a properly filled axial box and occlusal portion.

**89/92 Discoïd Cleoid**    1912S    \$42.99

Aids in forming a properly filled axial box and occlusal portion.

**4/5 Discoïd Cleoid**    1909AS    \$42.99

Aids in forming a properly filled axial box and occlusal portion.

**1/2 Hollenback**    1904S    \$42.99

Aids in forming a properly filled axial box and occlusal portion.

**CR21 Aesthetic Knife**    2454S    \$42.99

Aids in forming a properly filled axial box and occlusal portion.

**T-Flex Composite**    TFLEX    \$98.99

Aids in forming a properly filled axial box and occlusal portion.

**1 Goldstein**      **1834**      **\$32.99**

Small universal style with rounded plugger tip and a narrow paddle for initial placement and contouring of Class I, II, and III restorations.

**2 Goldstein**      **1835**      **\$32.99**

Larger universal style for final placement and contouring of Class I, II, and III restorations

**3 Goldstein Extra Flex**      **1836**      **\$32.99**

Flexible, reversed, flared paddle design for shaping and placement of Class III and IV restorations. placement and contouring of Class I, II, and III restorations

**4 Goldstein Extra Flex**      **1837**      **\$32.99**

Flexible, paired, offset, paddle-shaped blades for placing and shaping material on posterior, mesial and distal surfaces.

**1 Mini Goldstein**      **1838**      **\$32.99**

Mini version of 1 Goldstein for small pits and fissures, tunnel preparations or minor tooth defects on lower anteriors.

**2 Mini Goldstein**      **1839**      **\$32.99**

**3 Mini Goldstein Extra Flex**      **1840**      **\$32.99**

Mini version of 2 Goldstein. Can also be used for packing gingival retraction cord.

**4 Mini Goldstein Extra Flex**      **1841**      **\$32.99**

Mini version of 4 Goldstein for placing and shaping material in difficult to access mesial and distal posterior restorations.

**2 Woodson**      **1934**      **\$32.99**

**3 Woodson**      **1935**      **\$32.99**

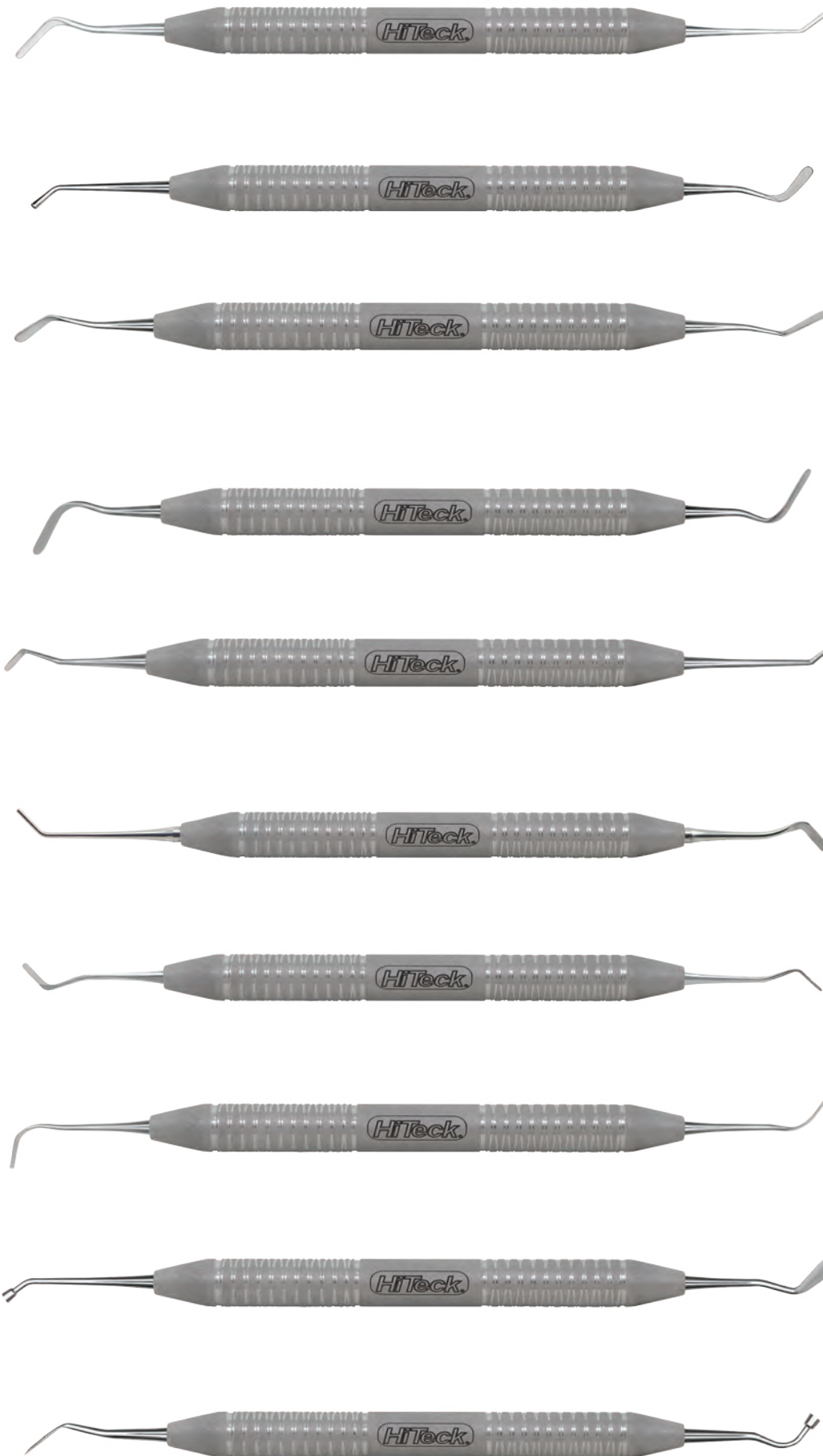

HATCHETS

13/14 1855 \$34.99

[20-9-14]



15/16 1856 \$34.99

[15-8-14]



17/18 1857 \$34.99

[10-6-14]



14/14 Off Angle 1860 \$34.99

[15-8-14]



15/15 Off Angle 1861 \$34.99

[15-8-14]



MARGIN TRIMMERS

26 Distal 1788 \$34.99

[13-95-8-14]



27 Mesial 1789 \$34.99

[13-80-8-14]



28 Distal 1790 \$34.99

[10-95-7-14]



29 Mesial 1791 \$34.99

[10-80-7-14]



CHISELS

3/4 Wedelstaedt 1794 \$34.99

[11.5-15-3]



5/6 Wedelstaedt 1795 \$34.99

[15-15-3]



1/2 Wedelstaedt 1796 \$34.99

[20-15-3]





PLACEMENT INSTRUMENT

Calcium Hydroxide Placer 2492 \$32.99

Calcium hydroxide or glass ionomer base/liner placement instrument. Also useful as a small burnisher.



# RESTORATIVE

	36/37 [15-8-14]	1819	\$32.99
	40/41 [11-7-14]	1820	\$32.99
	44/45 [20-9-14]	1821	\$32.99
	61/62 [2.0 mm]	1822	\$32.99
	63/64 [1.5 mm]	1823	\$32.99
	65/66 [10-6-12]	1824	\$32.99
	125/126 [2.5mm]	1825	\$32.99
	127/128 [2.0mm]	1826	\$32.99
	129/130 [1.7mm]	1827	\$32.99
	131/132 [1.4mm]	1828	\$32.99
	153/154 [1.0mm]	1829	\$32.99
	243 [1.0mm]	1830	\$32.99
	244 [1.4mm]	1831	\$32.99
	245 [2.0mm]	1832	\$32.99

#246	1833	\$32.99
17W	1816	\$32.99
18W	1817	\$32.99
19W	1818	\$32.99
Title	2361	\$32.99
E1	1807	\$32.99
E2	1808	\$32.99
E3	1809	\$32.99
6	1810	\$32.99
14	1811	\$32.99
17	1812	\$32.99
18	1813	\$32.99
19	1814	\$32.99
38/39	1815	\$32.99

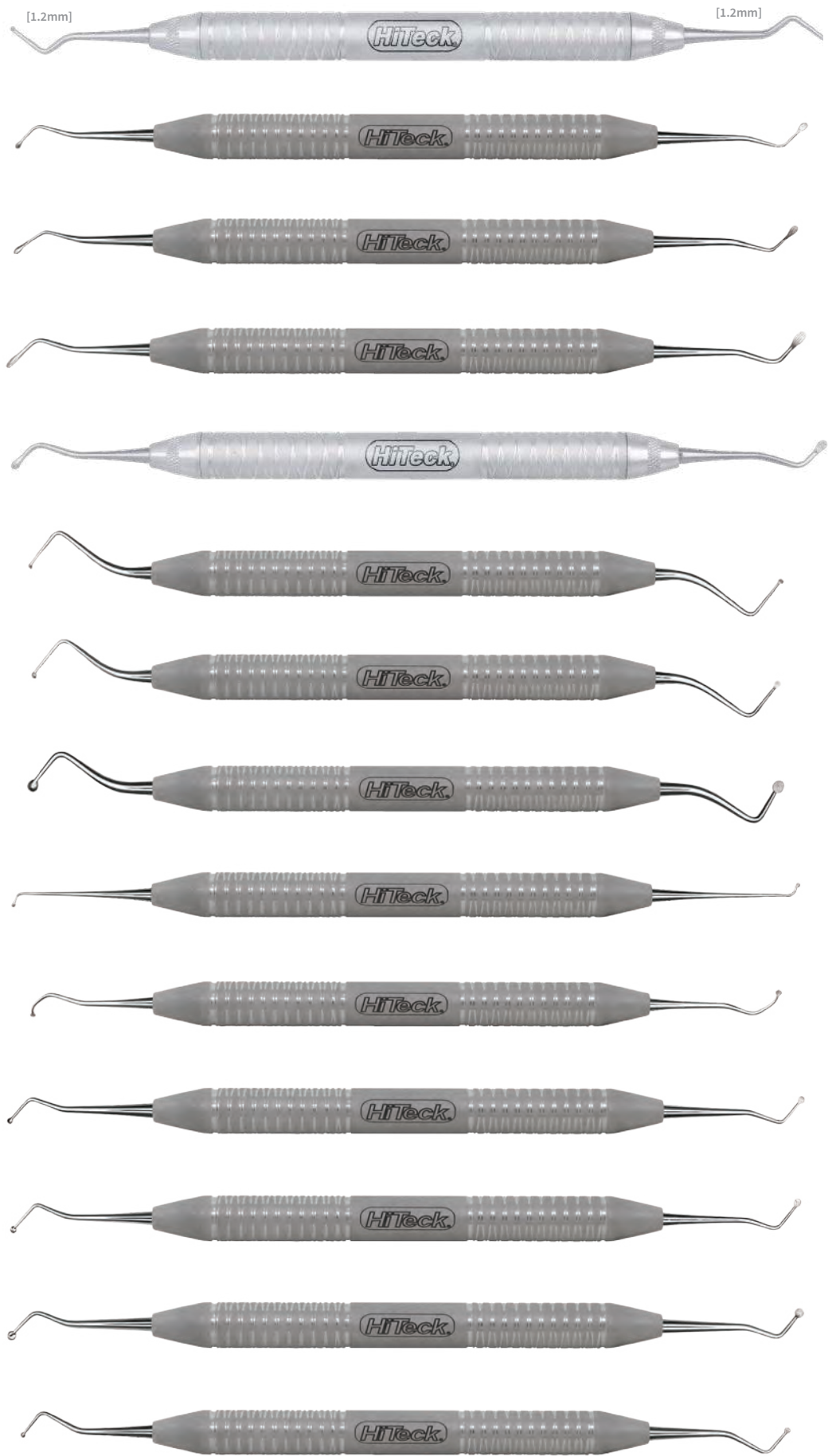



Miller  
Articulating  
Paper Forcep

1786

\$29.99



Non Slip

1871

\$32.99



1/2 Andrews

1874

\$32.99

[1.4mm], [2.0mm]



H1  
Hollenback

1875

\$32.99

[1.0mm], [1.65mm]



H2  
Hollenback

1876

\$32.99

[2.0mm], [2.7mm]



H3  
Hollenback

1877

\$32.99

[2.5mm], [2.5mm]



H4  
Hollenback

1878

\$32.99

[1.8mm], [2.4mm]



0/1 Marquette

1879

\$32.99

[1.0mm], [1.4mm]



2 Mortonson

1880

\$32.99

[0.6mm], [1.2mm]



1 Oregon

1887

\$32.99

[1.9mm], [1.2mm]



2 Oregon

1888

\$32.99

[1.0mm], [1.6mm]



3 Oregon

1889

\$32.99

[1.3mm], [2.2mm]



4 Oregon

1890

\$32.99

[2.0mm], [3.0mm]



1 Ward

1891

\$32.99

[1.2mm], [2.5mm]

<b>2 Ward</b>	<b>1892</b>	<b>\$32.99</b>
[2.2mm], [3.0mm]		
<b>3 Ward</b>	<b>1893</b>	<b>\$32.99</b>
[1.5mm], [1.9mm]		
<b>1T Tanner</b>	<b>1896</b>	<b>\$32.99</b>
[0.6mm], [0.76mm]		
<b>2T Tanner</b>	<b>1897</b>	<b>\$32.99</b>
<b>3T Tanner</b>	<b>1898</b>	<b>\$32.99</b>
<b>9/10 Back Action</b>	<b>1899</b>	<b>\$32.99</b>
[1.2mm], [1.6mm]		
<b>11/12 Back Action</b>	<b>1900</b>	<b>\$32.99</b>
[1.5mm], [2.0mm]		
<b>153 Serrated</b>	<b>1901</b>	<b>\$32.99</b>
[1.5mm], [2.5mm]		
<b>154 Serrated</b>	<b>1902</b>	<b>\$32.99</b>
[1.4mm], [2.4mm]		
<b>1/2 Black</b>	<b>2373</b>	<b>\$32.99</b>
[1.5mm], [2.5mm]		
<b>1/2 Serrated</b>	<b>2374</b>	<b>\$32.99</b>
[1.5mm], [2.5mm]		
<b>0/1 Marquette Serrated</b>	<b>2375</b>	<b>\$32.99</b>
[1.0mm], [1.4mm]		
<b>2 Serrated Smith</b>	<b>2376</b>	<b>\$32.99</b>
[1.5mm], [1.5mm]		
<b>SPO Serrated 76MM</b>	<b>2377</b>	<b>\$32.99</b>
[1.4mm], [2.0mm]		

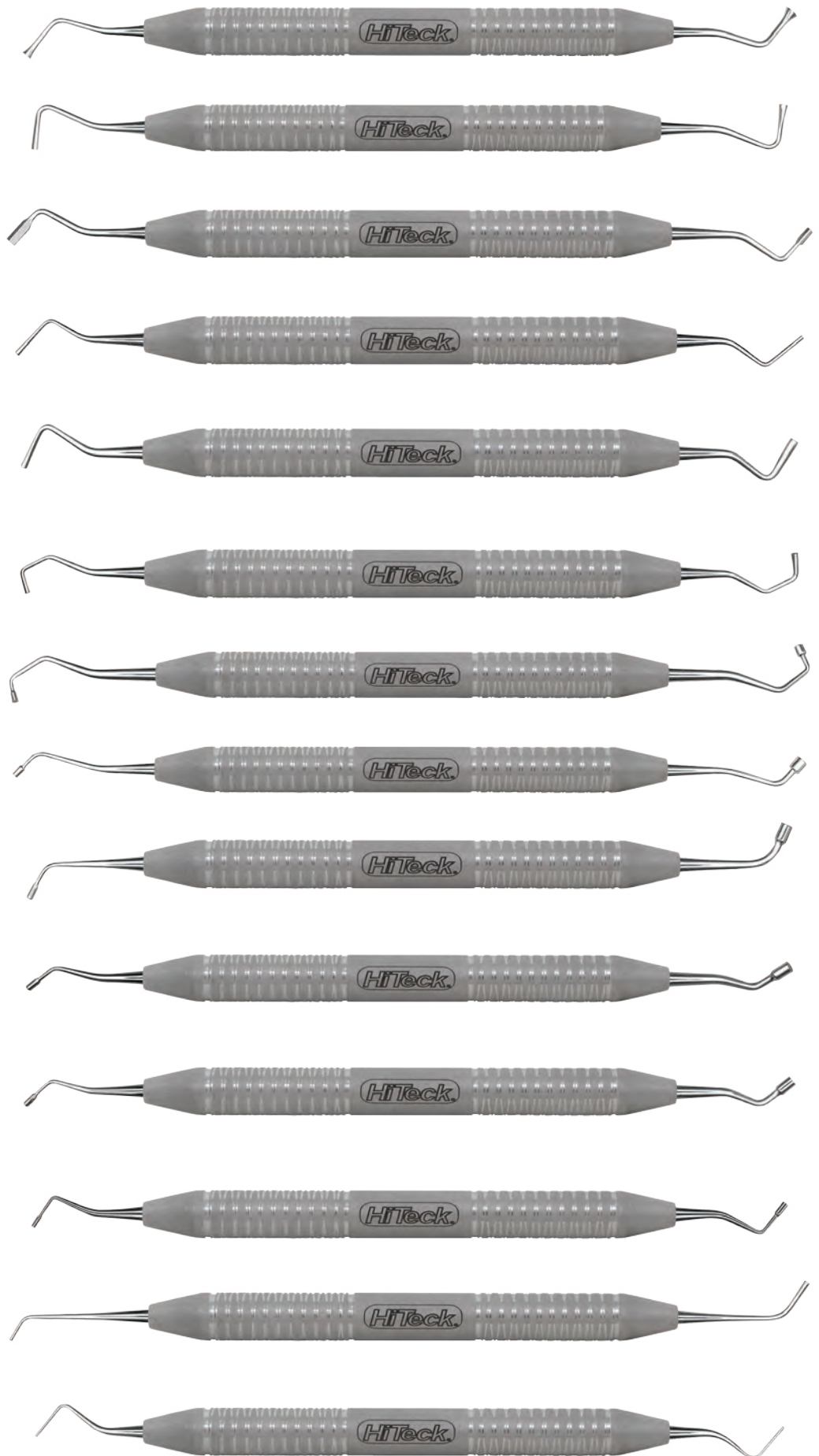

# RESTORATIVE



**Interproximal**      **1903**      **\$32.99**

Extremely thin, flexible blade; ideal for interproximal contouring.



**1/2 Hollenback**      **1904**      **\$32.99**

Universal adaptability. Ideal for placing, carving and contouring amalgam.



**3S Hollenback Carver**      **1905**      **\$32.99**

Design characteristics similar to 1/2 Hollenback but with slightly larger blades.



**3 Hollenback Carver**      **1906**      **\$32.99**

Design characteristics similar to 1/2 Hollenback but with significantly larger blades.



**8 Wiland**      **1907**      **\$32.99**

Extremely thin curved blade; ideal for adapting to interproximal surfaces.



**1/2 Discoid Cleoid**      **1908**      **\$32.99**



**4/5 Discoid Cleoid**      **1909**      **\$32.99**



**3/6 Discoid Cleoid**      **1910**      **\$32.99**



**89/92 Discoid Cleoid**      **1912**      **\$32.99**



**Interproximal Off Angle**      **2378**      **\$32.99**

Extremely thin, flexible blade. Off-angle provides better access to posterior areas.



**6 Tanner**      **2382**      **\$32.99**



**1 Hollenback**      **2395**      **\$32.99**



**2 Hollenback**      **2396**      **\$32.99**



**L7 Levy Carver**      **2397**      **\$32.99**



**21 Aesthetic Carving Knife**      **2454**      **\$34.99**

**21 Acorn**      **1917**    **\$32.99**

Extremely thin, flexible blade; ideal for interproximal contouring.



**21B Acorn**      **2314**    **\$32.99**

Extremely thin, flexible blade; ideal for interproximal contouring.



**18**                      **1918**    **\$32.99**

Extremely thin, flexible blade; ideal for interproximal contouring.



**26/27S**              **1919**    **\$32.99**

Extremely thin, flexible blade; ideal for interproximal contouring.



**27/29**                      **1920**    **\$32.99**

Extremely thin, flexible blade; ideal for interproximal contouring.



**28/29**                      **1921**    **\$32.99**

Extremely thin, flexible blade; ideal for interproximal contouring.



**2 Beavertail**        **1914**    **\$32.99**

Extremely thin, flexible blade; ideal for interproximal contouring.



**2 Double Ended Beavertail**      **1915**    **\$32.99**

Extremely thin, flexible blade; ideal for interproximal contouring.



**2/29 Beavertail**      **1916**    **\$32.99**

Extremely thin, flexible blade; ideal for interproximal contouring.



**2 Ladmore**              **1922**    **\$32.99**

Extremely thin, flexible blade; ideal for interproximal contouring.



**3 Ladmore**              **1923**    **\$32.99**

Extremely thin, flexible blade; ideal for interproximal contouring.



**Straight Interproximal**      **300-123**    **\$89.99**

For anterior crown removal.



**45° Angle**                      **300-124**    **\$89.99**

For cuspids, bicuspids and even first molars.



**Occlusal**                      **300-125**    **\$89.99**

For occlusal separation especially in hard to remove crowns that have been bonded to the tooth.



**Right Angle**                      **300-126**    **\$89.99**

For molars.

# RESTORATIVE



Christensen Crown Remover 2603 \$89.99

Straight



Christensen Crown Remover 2604 \$89.99

Right Angled



Temporary Crown Remover 1805 \$149.99



Crown Removing Pliers, 14cm 1806 \$89.99



Trial Lower Crown Remover 2605 \$129.99



Trial Upper Crown Remover 2606 \$129.99



24 Flexible (44mm) 1924 \$32.99

Flexible blade for mixing medium body cements.



324 Rigid (51mm) 1925 \$32.99

Rigid blade for mixing heavier or medium body cements.



A6 Rigid (25mm) 1926 \$32.99



7 Tapered 1927 \$32.99



8R Rigid 300-130 \$32.99



5A Knife 300-131 \$32.99



**1 Iwanson Spring Caliper**

For metal and porcelain

**1783** | \$29.99



**Boley Gauge**

**1785** | \$44.99



**2 Iwanson Spring Caliper**

For wax

**1784** | \$29.99

**LeCron Wax Carver**

For metal and porcelain

**300-127** | \$29.99



**Roach Wax Carver**

**300-128** | \$44.99



**Vehe Wax Carver**

For wax

**300-129** | \$29.99



**PKT 1**      **1928**    **\$32.99**

Curved tapered tips used to flow on molten wax.



**PKT 2**      **1929**    **\$32.99**

Curved tapered tips used to flow on molten wax.



**PKT 3**      **1930**    **\$32.99**

Pointed burnisher used to perfect and enhance the supplemental and developmental grooves.



**PKT 3R**      **1931**    **\$32.99**

Similar to PKT 3, but with a rounded tip vs. a pointed one.



**PKT 4**      **1932**    **\$32.99**

Modified carver used to perfect the external contours and remove excess wax at the cavosurface margins.



**PKT 5**      **1933**    **\$32.99**

Special carver used to remove excess wax as cusp ridges are developed; its contour maintains desired convexity at these ridges.





**The Tear Drop**  
400-101 | \$149.99

An instrument created to add a notch at the gingival margin of clear aligners anywhere elastic hooks are required within the arch. The Tear Drop provides a reservoir to hold the elastics in place as the aligner is seated. This permits easier manipulation of elastics by the patient.



**The Horizontal**  
400-103 | \$149.99

The Horizontal instrument produces an indentation to accent individual root torque. It also serves a second purpose by enhancing retention of either clear aligners or retainers by placing an indent into a tooth's undercut or below a bonded attachment to enhance the contact of the aligner to that attachment.



**The Hole Punch**  
400-104 | \$149.99

The Hole Punch is used to create 6mm half-moon cutouts for relief of clear aligners around bonded buttons used for elastics. No need to attempt to attach buttons to plastic trays. In addition, the Hole Punch can nip away plastic to provide soft tissue clearance to prevent aligner impingement of tissue.



**The Spot**  
678-804 | \$149.99

The Spot creates a tiny, rounded dimple for spot contacts to accent small individual tooth movements or added aligner retention. It is typically used to accent movements on any tooth that just needs a slight "nudge". The Spot's small depression placed adjacent to the gingival embrasures can also enhance the retentiveness of an aligner or retainer.



**The Vertical**  
400-102 | \$149.99

Correcting rotations is often a challenge with aligners. The Vertical emphasizes over-correction of rotations by producing an indentation at the mesial or distal line angles on the facial and/or lingual of a specific tooth. As an option, a rotational couple can also be created using vertical indents on facial and lingual surfaces on opposing sides of a tooth. The Vertical can also be used to produce an indent to produce a mild "nudge" to enhance resolution of in-and-out discrepancies. It can also be used to apply an indent immediately next to an attachment to enhance the adaptation of the aligner to angle between that attachment and the aligner.



**The Counter Clockwise Wedge**  
678-807 | \$149.99

The Counter Clockwise Wedge is used to produce a wedge-shaped indent in an aligner at the facial and at the opposite line angle lingual for a specific tooth to create a rotational couple. Used to create a counter clockwise rotation.



**The Eraser**  
678-811 | \$149.99

The Eraser is designed to reverse or remove unwanted indents placed by other instruments in the Clear Aligner Series. The Eraser is designed to flatten the plastic where a depression was inadvertently positioned, or the accent is no longer required.

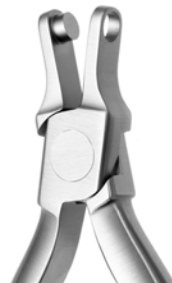

**The Petite Punch**  
678-805 | \$149.99

The Petite Punch cuts a 4.5mm half-moon cutout in an aligner for relief of the plastic around bonded buttons used for elastics. When only a small cut-out is required to provide clearance for buttons or hooks on the buccal but also on the lingual of any tooth in the aligner, especially for smaller teeth. The Petite Punch can also nip away plastic to provide soft tissue clearance to prevent aligner impingement of tissue.



**The Clockwise Wedge**  
678-808 | \$149.99

The Clockwise Wedge is used to produce a wedge-shaped indent in an aligner at the facial and at the opposite line angle lingual for a specific tooth to create a rotational couple. Used to create a clockwise rotation.



Universal Cut & Hold Distal End Cutter

400-105 | \$149.99  
400-105L | \$149.99



Hard Wire Cutter, 15°  
400-108 | \$149.99



Micro-Mini Pin & Ligature Cutter  
400-111 | \$149.99  
400-111L | \$149.99



Flush Cut Distal End Cutter, No Hold  
400-106 | \$149.99



Multi Use Pin & Ligature Cutter  
400-107 | \$149.99



Mini Pin & Ligature Cutter  
400-109 | \$149.99



Hard Wire Cutter  
400-110 | \$149.99



Micro-Mini Pin & Ligature Cutter, 15°  
400-113 | \$149.99



Slim Micro Cutter  
400-114 | \$149.99



Micro Cutter  
400-115 | \$149.99



Lingual Distal End Cutter  
400-116 | \$149.99



Lingual Pin & Lig Cutter  
400-118 | \$149.99



Flush Cut & Hold Distal End Cutter  
678-111 | \$149.99



3 Silicone Replacement Rings for  
678-113  
678-113 | \$149.99





Weingart Pliers  
400-119 | \$139.99



Adhesive Removing Pliers  
400-124 | \$139.99



Posterior Band Removing Pliers,  
Long  
400-125 | \$139.99



Bracket Removing Pliers  
400-130 | \$139.99



Slim Weingart Pliers  
400-120 | \$139.99



Weingart Pliers, Long Handle  
400-119L | \$139.99



How Pliers  
400-121 | \$139.99



How Pliers, Offset  
400-122 | \$139.99



Band Seating Pliers  
400-123 | \$139.99



Posterior Band Removing Pliers,  
Short  
400-126 | \$139.99



Tip Back Pliers  
400-129 | \$139.99



Angulated Bracket  
Removing Pliers  
400-131L | \$139.99



Crown & Band  
Contouring Pliers  
400-132 | \$139.99



Slim Crown & Band  
Contouring Pliers  
400-132M | \$139.99



Slim Crown & Band Contouring  
Pliers, Modified  
400-132 MC | \$139.99



Band Crimping Pliers  
400-134 | \$139.99

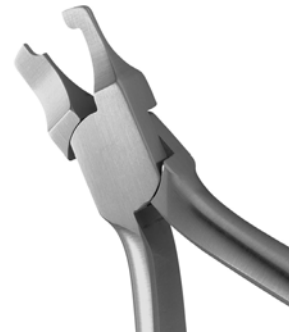

Band Crimping Pliers with Spring  
400-134M | \$139.99



Ultra Slim Weingart Pliers  
400-135 | \$139.99



Slim Band Removing Pliers  
400-136 | \$139.99



Lingual Weingart Pliers  
400-137 | \$139.99  
90 Degree Bend



Lingual Weingart Pliers  
400-138 | \$139.99  
90 Degree Bend



Lingual Bracket  
Removing Pliers  
400-139 | \$139.99



Force Module  
Separating Pliers  
678-210 | \$139.99



Coon Style Ligature Tying Pliers  
678-211 | \$139.99

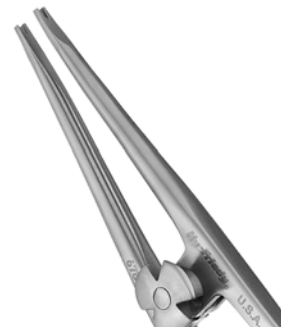

Steiner Tying Pliers  
678-222 | \$139.99



Lingual Debonding Pliers  
678-709 | \$139.99



**Bird Beak Pliers**  
400-142 | \$139.99



**V-Stop Pliers**  
400-157 | \$139.99



**Three Jaw Pliers**  
400-140 | \$139.99



**Omega Loop Forming Pliers**  
400-141 | \$139.99



**Light Wire Bird Beak Pliers with Groove**  
400-143 | \$139.99



**Tweed Loop Forming Pliers**  
400-144 | \$139.99



**Arch Bending Pliers**  
400-145 | \$139.99



**Tweed Pliers, Slim**  
400-145S | \$139.99



**Rectangular Arch Bending Pliers**  
400-146 | \$139.99



**Lingual Arch Forming Pliers**  
400-147 | \$139.99



**Hollow Chop Contouring Pliers**  
400-148 | \$139.99



**O'Brien Pliers**  
400-149 | \$139.99



**Mini Three Jaw Pliers**  
400-150 | \$139.99



**General Contouring Pliers**  
400-151 | \$139.99



**Marcotte Looping Pliers**  
400-152 | \$139.99



**Hollow Chop Pliers**  
400-153 | \$139.99



**Light Wire Bird Beak Pliers**  
400-154 | \$139.99



**Nance Loop Forming Pliers**  
400-155 | \$139.99



**Adams Pliers**  
400-156 | \$139.99



**NiTi Three Jaw Pliers**  
400-158 | \$139.99



**Optical Pliers**  
400-159 | \$139.99



**Old Style Loop Pliers**  
400-160 | \$139.99



**Bird Beak Pliers with Cutter**  
400-161 | \$139.99



**Long Tapered Bird Beak Pliers**  
400-162 | \$139.99



**Hammerhead NiTi Tie-Back Pliers**  
400-163 | \$139.99



**Torquing Pliers**  
400-164 | \$139.99  
.016"/.018" Key  
400-165 | \$139.99  
.018"/.022" Key



**Step Pliers**  
400-166 | \$139.99  
1/2 MM  
400-167 | \$139.99  
1 MM  
400-168 | \$139.99  
3/4 MM



**Slim Hammerhead NiTi Pliers**  
400-169 | \$139.99



**Lingual Hammerhead NiTi Pliers**  
400-170 | \$139.99  
400-170SER | \$139.99



**Lingual Hammerhead NiTi Pliers**  
400-173 | \$139.99



**Occlusal-Small with Handle,**  
60x90x100MM  
HMSM-304 | \$99.99

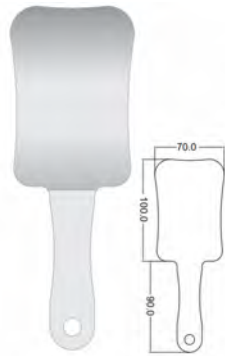

**Occlusal-Medium with Handle,**  
70x90x100MM  
HMSM-204 | \$99.99

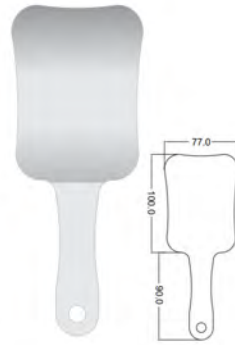

**Occlusal-Large with Handle,**  
77x90x100MM  
HMSM-104 | \$99.99

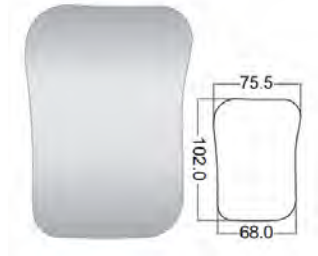

**C-Occlusal Adult 75.5x68x102MM**  
HMSM-305 | \$99.99



**A-Lingual**  
42.5x61x160MM  
HMSM-105 | \$99.99

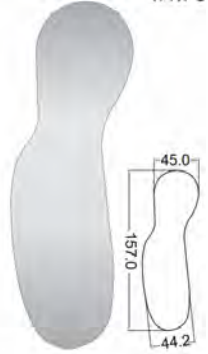

**B-Buccal 45x44.2x157MM**  
HMSM-205 | \$99.99



**Adult/Child Squared Occlusal, 150° angle**  
HMSM-307 | \$99.99



**Child Occlusal/Buccal 150° angle**  
HMSM-707 | \$99.99



**D-Occlusal XL Adult 77.5x71x-129.5MM**  
HMSM-405 | \$99.99



**E-Occlusal Medium**  
69x60.5x129.5MM  
HMSM-505 | \$99.99

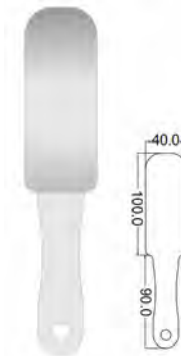

**Lateral Photography**  
40x90x100MM  
HMSM-404 | \$99.99



**Adult/Child Rounded Occlusal, 150° angle**  
HMSM-107 | \$99.99



**Adult/Child Buccal 150° angle**  
HMSM-607 | \$99.99



**Adult Occlusal/Buccal 150° angle**  
HMSM-407 | \$99.99



**Lingual Upper/Lower 150° angle**  
HMSM-507 | \$99.99



**Buccal 150° angle**  
HMSM-207 | \$99.99



Crown & Gold Scissor, 12CM

SCGC | Curved | \$59.99  
 SCGS | Straight | \$59.99

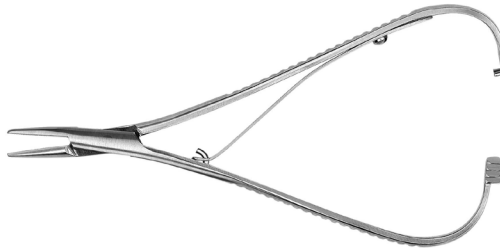

Ortho Mathieu, Narrow Tip Pliers

400-174 | Narrow Tip | \$84.99  
 400-175 | Wide Tip | \$84.99  
 400-176 | Tungsten Carbide | \$124.99



Lingual Mathieu Pliers  
 400-177 | \$89.99



Crown & Gold Scissors, Pedro  
 400-178 | \$69.99



Wire-Cutting Scissors  
 400-179 | \$69.99



Direct Bond Bracket Holder  
 400-180 | \$54.99



Slim Direct Bond Bracket Holder  
 400-181 | \$54.99



Slim Buccal Tube Bonder Tweezers  
 400-183 | \$54.99

Slim Direct Bond Bracket Tweezers  
 400-182 | \$54.99



Band Pusher  
 400-197 | \$74.99

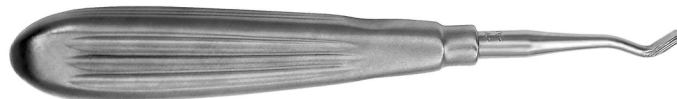

Band Pusher with Short tip  
 400-198 | \$74.99



Distal Clinch Back Hand Instrument  
 400-184 | \$34.99





































Lingual Ligature Director  
 400-185 | \$34.99



Lingual Ligature Director, U Shape  
 400-186 | \$34.99



	Scaler/Band Pusher 400-187   \$34.99	
	Ligature Director Scaler 400-188   \$34.99	
	Dull Scaler/Band Pusher 400-189   \$34.99	
	Ligature Director/Band Pusher 400-191   \$34.99	
	Large Plugger/Picker 400-192   \$34.99	
	Dull Scaler 400-193   \$34.99	
	Dull Scaler (H6/7) 400-194   \$34.99	
	Ligature Director/ Band Pusher 400-195   \$34.99	
	Picker/Ligature Director 400-196   \$34.99	
	Tucker/Ligature Director 400-201   \$34.99	
	Band Pusher Short Tip/Scaler 400-200   \$34.99	
	Gingrass Ligature Director 400-202   \$34.99	
	Lingual Torquing Key, .018" 400-203   \$34.99	
	Straight .020" Wire Applicator 400-204   \$34.99	
	Lingual Torquing Key/Picker 678-708   \$34.99	
	Ligature Director/Plugger LDP   \$34.99	
	Standard Ligature Director PLPK   \$34.99	

### Exam Cassette for 5 Instruments

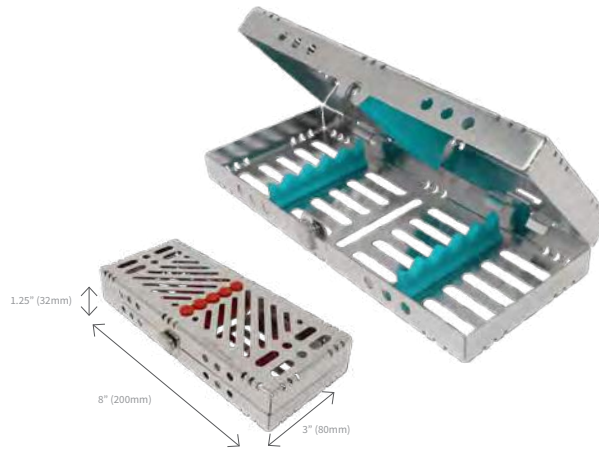

**HMCT-1605** | \$134.99

Exterior Dimensions 3" x 8" x 1.25"  
(200 mm x 80 mm x 32 mm)



### Small Cassette for 7 Instruments, Detachable

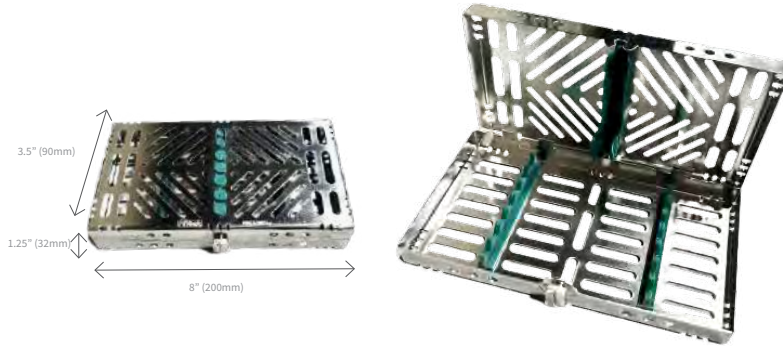

**HMCT-1607** | \$149.99

Exterior Dimensions 8" x 3.5" x 1.25"  
(200 mm x 90 mm x 32 mm)

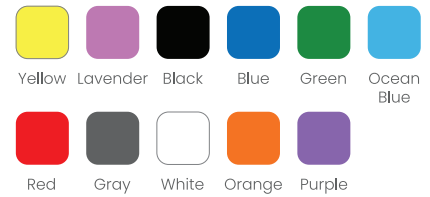

### Small Cassette for 10 Instruments



**HMCT-1610** | \$154.99

Exterior Dimensions 5.5" x 8" x 1.25"  
(140 mm x 203 mm x 32 mm)

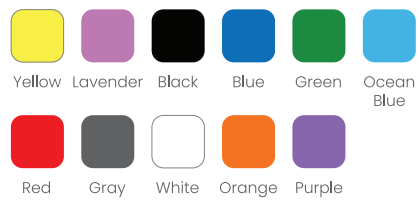

### Large Cassette for 20 Instruments

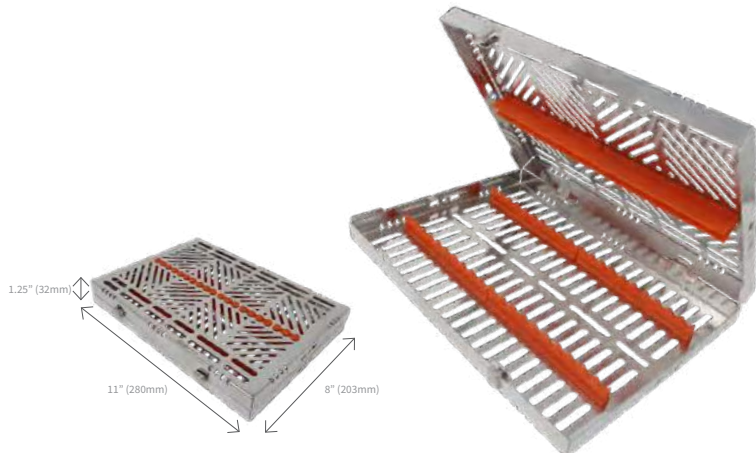

**HMCT-1620** | \$209.99

Exterior Dimensions 8" x 11" x 1.25"  
(203 mm x 280 mm x 32 mm)





## Exam Cassette for 5 Instruments & Accessory Area

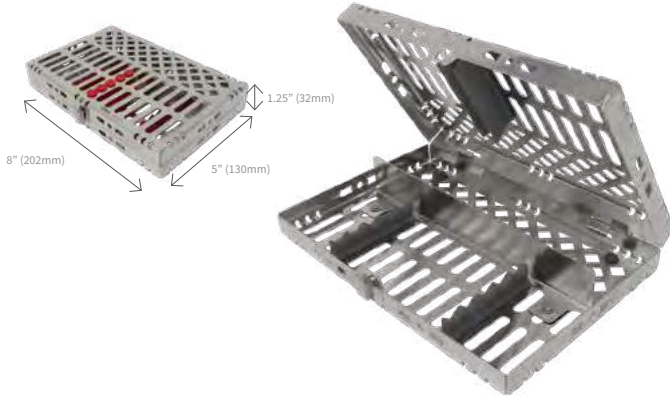

**HMCT-2205 | \$159.99**

Exterior Dimensions 8" x 5" x 1.25"  
(202 mm x 130 mm x 32 mm)



## Sterilization Cassette for 8 Instruments with Adjustable Accessory Area, Detachable



**HMCT-2208 | \$169.99**

Exterior Dimensions 8" x 5.5" x 1.2"  
(202 mm x 140 mm x 30 mm)



## Small Cassette for 10 Instruments & Accessory Area

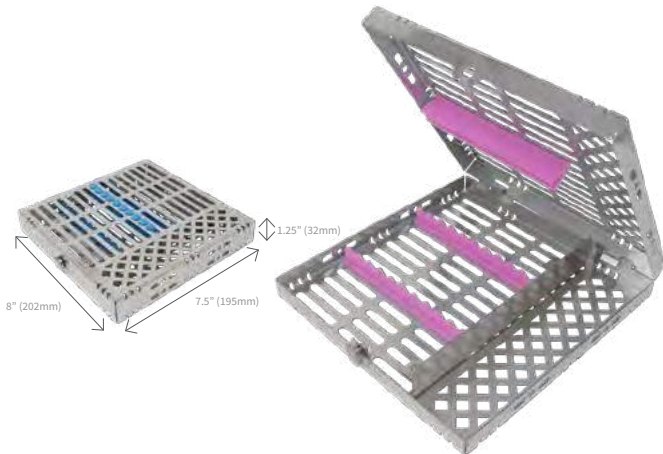

**HMCT-2210 | \$194.99**

Exterior Dimensions 8" x 7.5" x 1.25"  
(202 mm x 195 mm x 32 mm)



## Large Cassette for 16 Instruments & Accessory

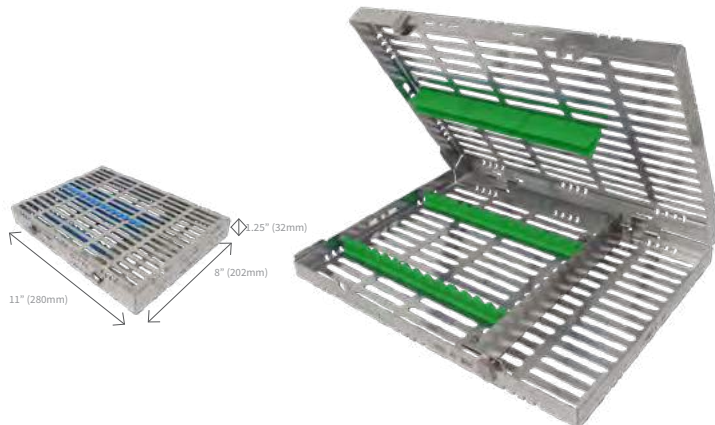

**HMCT-2216 | \$214.99**

Exterior Dimensions 8" x 11" x 1.25"  
(202 mm x 280 mm x 32 mm)



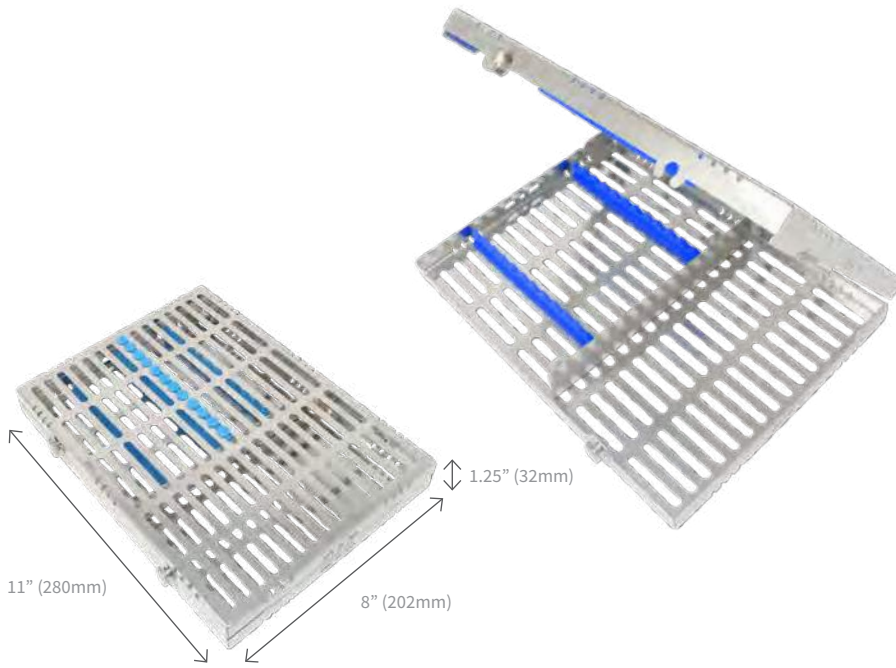

### Large Cassette for 20 Instruments & Accessory

**HMCT-2212** | \$214.99

Exterior Dimensions 8" x 11" x 1.25"  
(202 mm x 280 mm x 32 mm)



### Sterilization Cassette for 12 Instruments with Accessory Area, Detachable

**HMCT-2212MC** | \$214.99

Exterior Dimensions 6.5" x 10.5" x 1.25"  
(165 mm x 267 mm x 32 mm)

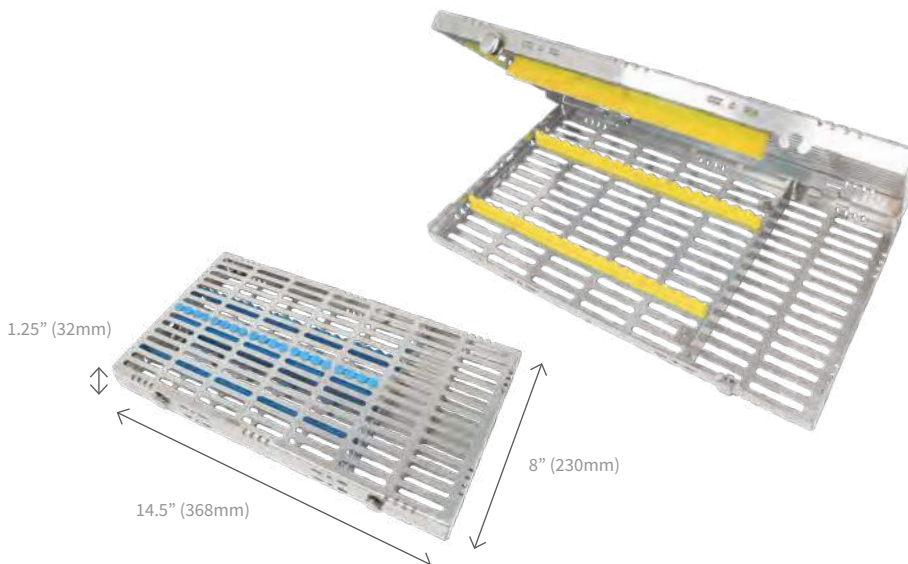

### Large Cassette for 20 Instruments & Accessory

**HMCT-2220** | \$349.99

Exterior Dimensions 8" x 14.5" x 1.25"  
(230 mm x 368 mm x 32 mm)



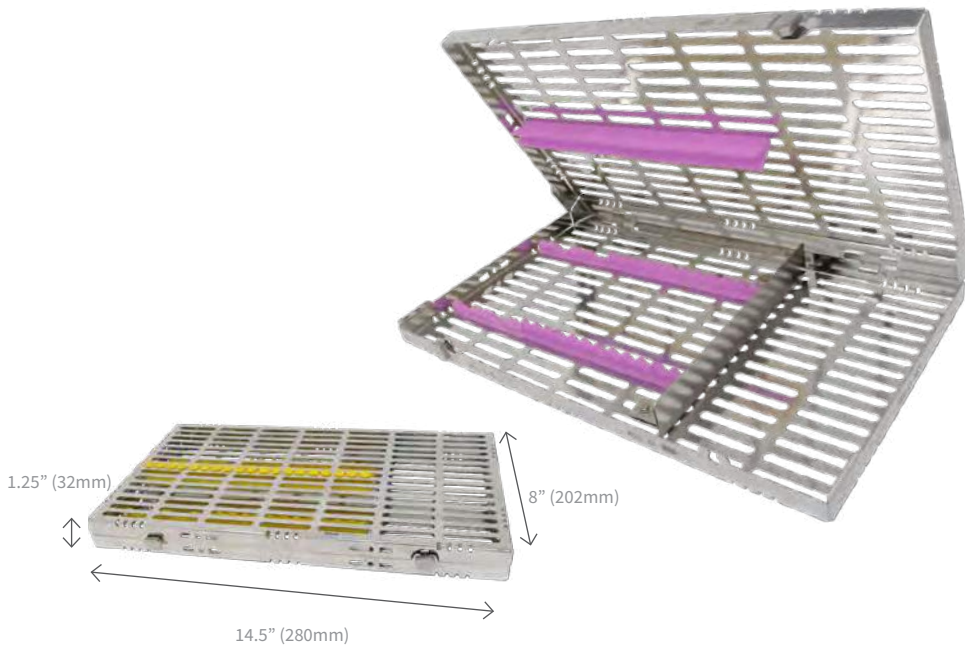

## Oral Surgery Cassette

**HMCT-2214 | \$349.99**

Exterior Dimensions 8" x 14.5" x 1.25"  
(202 mm x 280 mm x 32 mm)

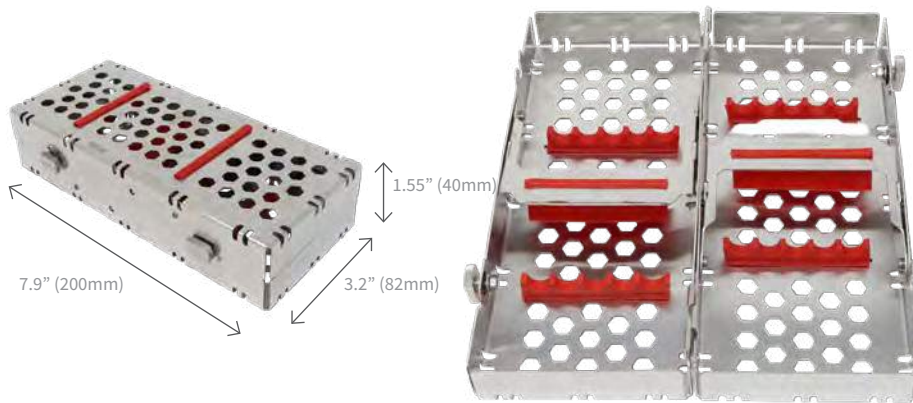

## Small Twin Cassette - Holds 10 Instruments

**HMSCT-1910 | \$209.99**

Exterior Dimensions 7.9" x 3.2" x 1.55"  
(200 mm x 82 mm x 40 mm)

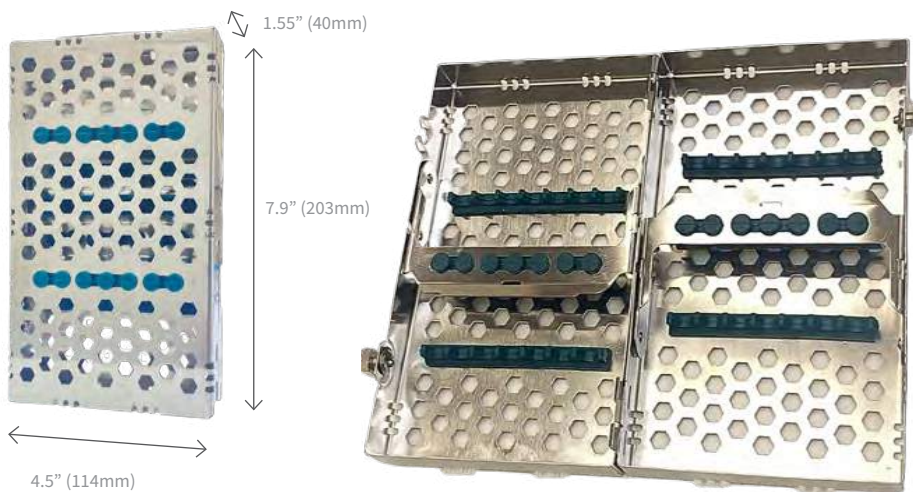

## Medium Twin Cassette - Holds 14 Instruments

**HMSCT-1914 | \$219.99**

Exterior Dimensions 7.9" x 4.5" x 1.55"  
(114 mm x 203 mm x 40 mm)



## Large Twin Cassette - Holds 20 Instruments

**HMSCT-1920** | \$229.99

Exterior Dimensions 7.9" x 5.2" x 1.55"  
(200 mm x 132 mm x 40 mm)



## Small Thin Orthodontic Cassette

**HMMT-4ORTH** | \$209.99

Exterior Dimensions 7" x 8" x 0.75"  
(178 mm x 203 mm x 19 mm)



## Large Thin Orthodontic Cassette

**HMMT-7ORTH** | \$224.99

Exterior Dimensions 8" x 11" x 0.75"  
(203 mm x 280 mm x 19 mm)

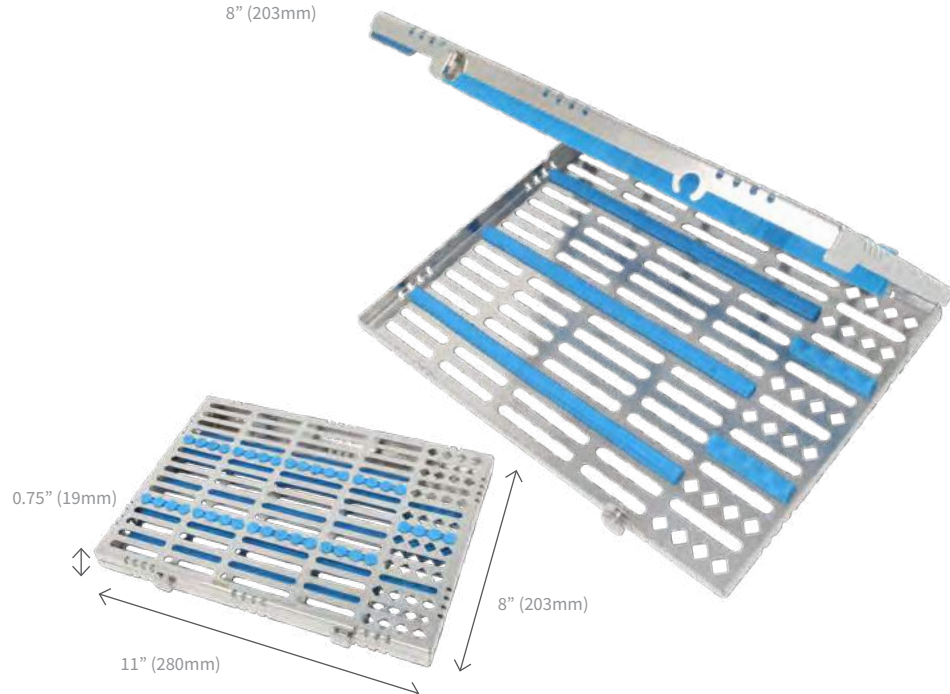

## Mini Exam Cassette for 3 Instruments

### HMCT-1403 | \$69.99

Exterior Dimensions 7" x 2.2" x 0.9"  
(180 mm x 55 mm x 22 mm)

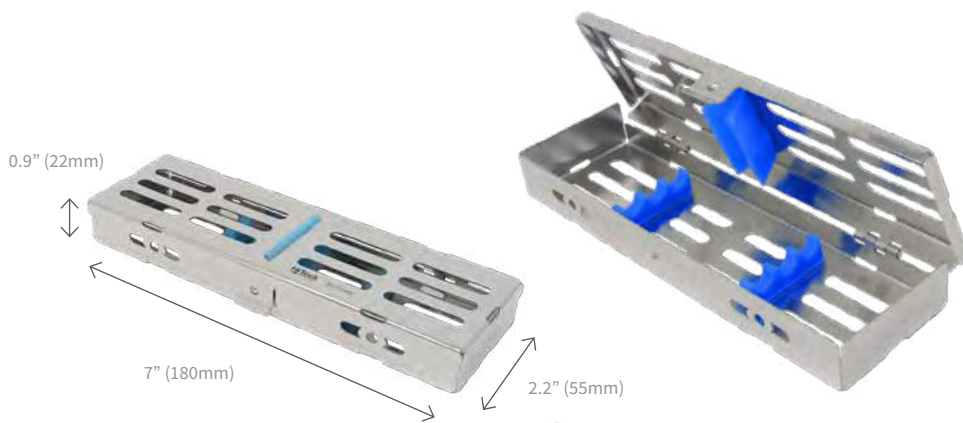

## Exam Cassette for 5 Instruments

### HMCT-1405 | \$74.99

Exterior Dimensions 7" x 2.8" x 0.9"  
(180 mm x 70 mm x 22 mm)

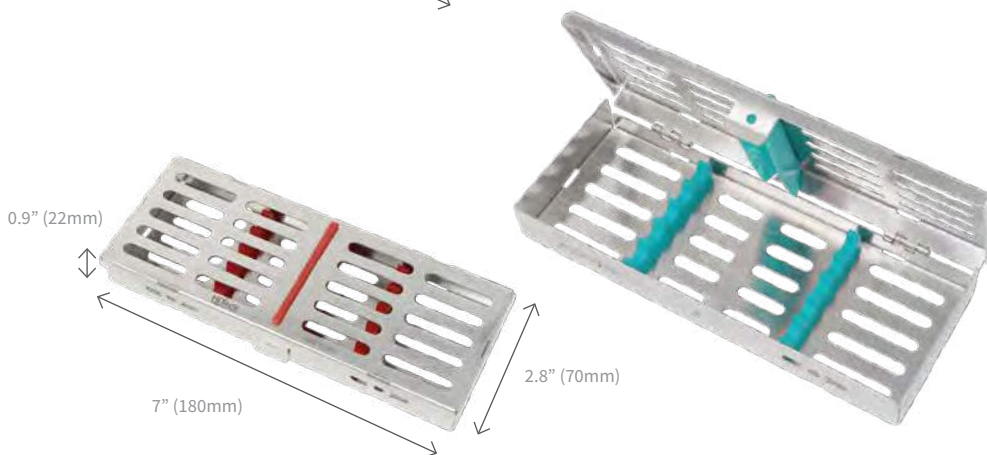

## Small Cassette for 7 Instruments

### HMCT-1407 | \$84.99

Exterior Dimensions 7" x 3.5" x 0.9"  
(180 mm x 90 mm x 22 mm)

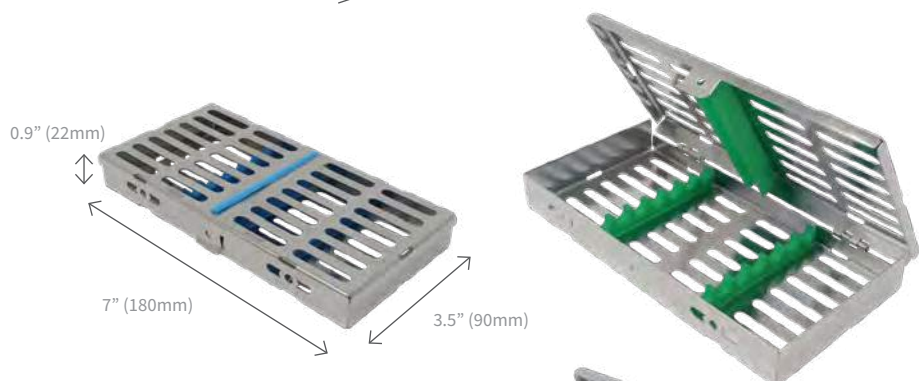

## Small Cassette for 10 Instruments

### HMCT-1410 | \$94.99

Exterior Dimensions 7" x 5.1" x 0.9"  
(180 mm x 130 mm x 22 mm)

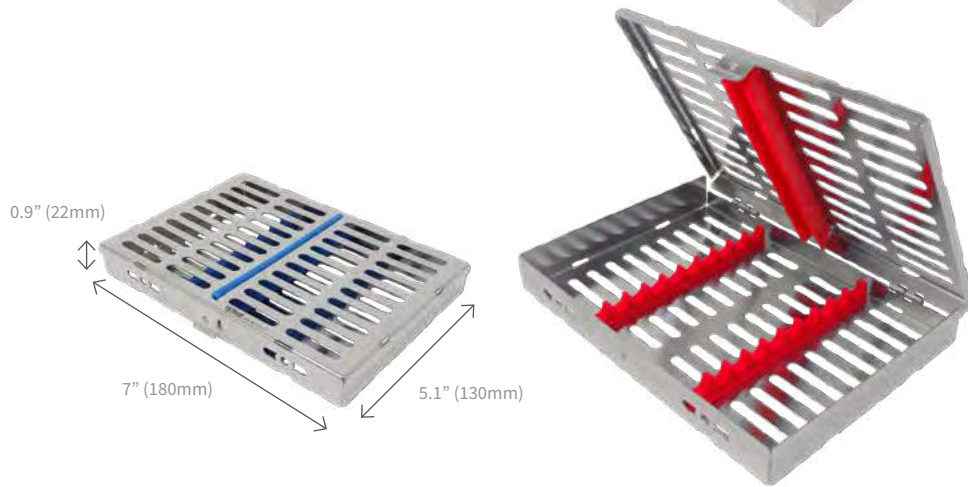

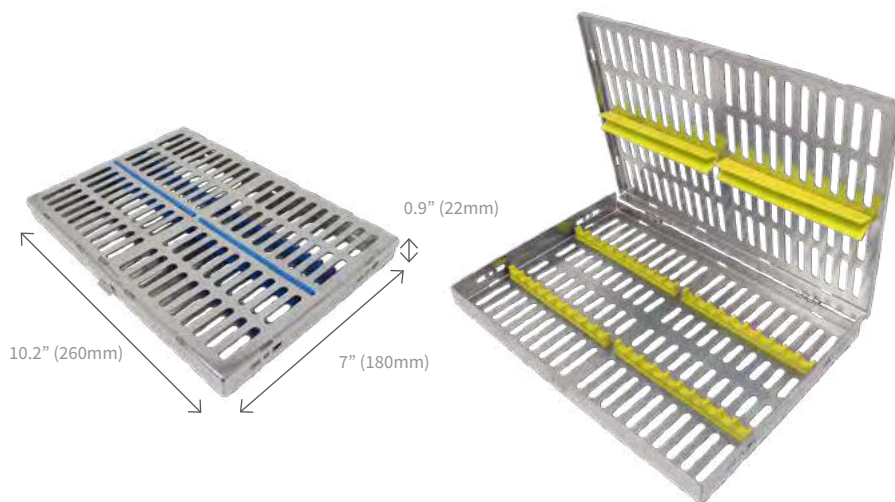

### Large Cassette for 20 Instruments

**HMCT-1420** | \$124.99

Exterior Dimensions 10.2" x 7" x 0.9"  
(260 mm x 180 mm x 22 mm)

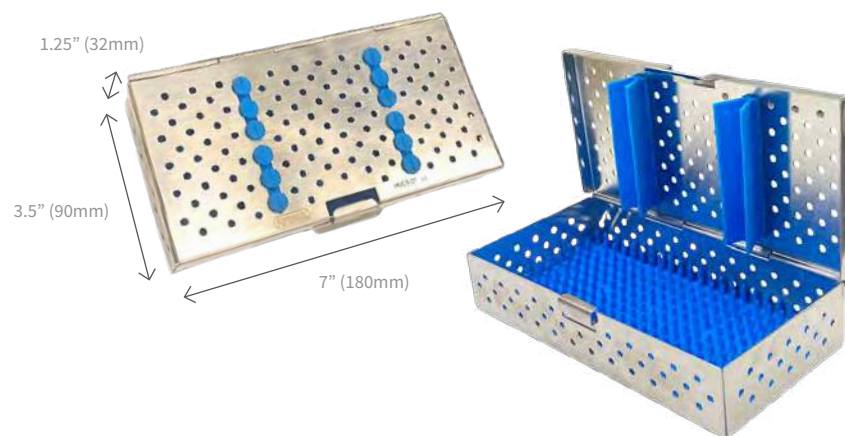

### Cassette for Multiple Handpieces

**CS7** | \$97.99

Exterior Dimensions 7" x 3.5" x 1.25"  
(180 mm x 90 mm x 32 mm)



### Small Ultrasonic Cassette

**SUSTC1** | \$129.99

Exterior Dimensions 8" x 1.25" x 1.5"  
(203 mm x 38 mm x 32 mm)

Cassette holds 2 Ultrasonic Inserts or 1 Handpiece



### Medium Ultrasonic Cassette

**MUSTC4** | \$149.99

Exterior Dimensions 8" x 3" x 1.25"  
(203 mm x 76 mm x 32 mm)

Cassette holds up to 3 high-speed Handpieces or 5 Ultrasonic Inserts.

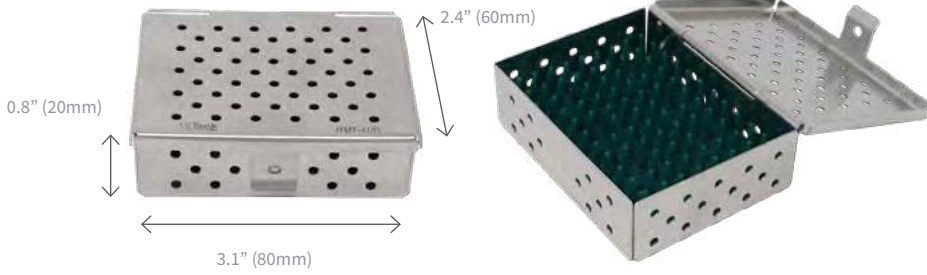

**Small Parts Cassette - Size B**

**HMMT-4105 | \$64.99**

Exterior Dimensions 3.1" x 2.4" x 1"  
(80 mm x 60 mm x 20 mm)

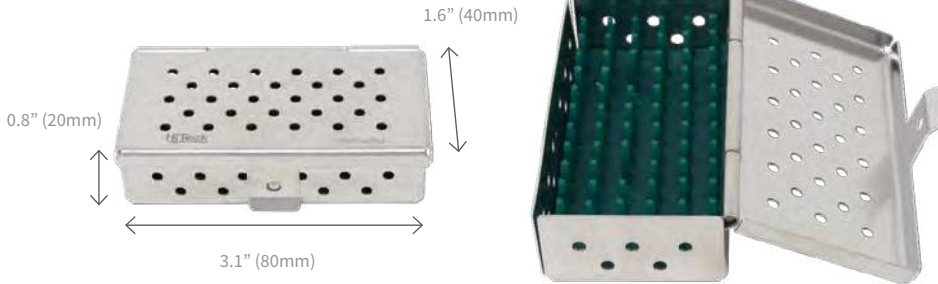

**Small Parts Cassette - Size A**

**HMMT-4104 | \$59.99**

Exterior Dimensions 3.1" x 1.6" x 0.8"  
(80 mm x 40 mm x 20 mm)

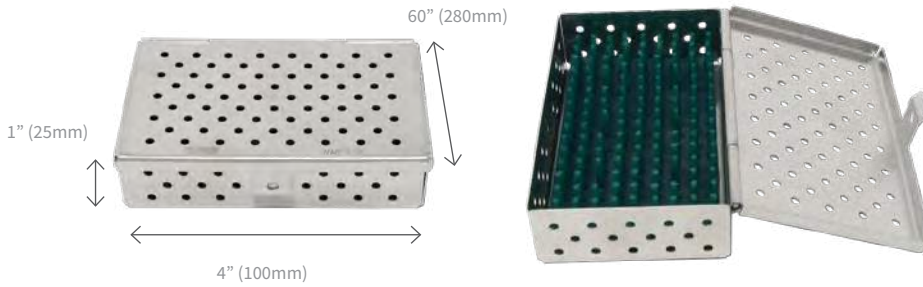

**Small Parts Cassette - Size C**

**HMMT-4106 | \$64.99**

Exterior Dimensions 4" x 2.4" x 1"  
(100 mm x 60 mm x 25 mm)

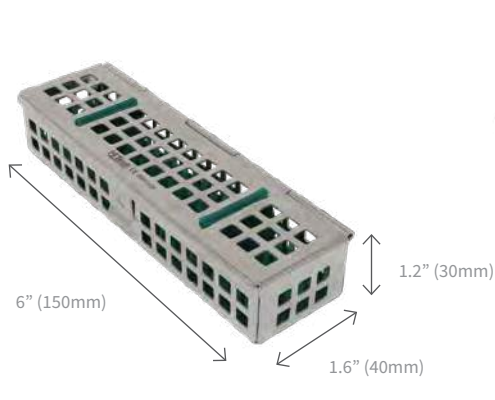

**Single Handpiece Cassette**

**HMMT-4112 | \$74.99**

Exterior Dimensions 6" x 1.6" x 1.2"  
(150 mm x 40 mm x 30 mm)



**Clip for Cassettes**

**AWCLIP | \$8.99**

Used to securely hold air water syringe tip and hinged instruments on the lid of the cassette.



DIAGNOSTIC



RESTORATIVE



SURGICAL



PERIODONTAL



ORTHODONTIC



INSTRUMENT  
MANAGEMENT



ENDODONTIC



IMPLANTS

To Learn more about HiTeck's Products & Services visit [hiteckmedical.com](http://hiteckmedical.com)

**Manufacturer:** 18-215 Traders Blvd East | Mississauga, ON L4Z 3K5 | Canada

**Toll Free:** 877.899.1861 **Toll Free Fax:** 888.891.9792

**Website:** [www.hiteckmedical.com](http://www.hiteckmedical.com)

Copyright 2020 HiTeck Medical Instruments. All rights reserved. The contents of this product catalog including, but not limited to, all text, photographs and graphics, are the sole and exclusive property of HiTeck Medical Instruments and may not be copied, reproduced or distributed without prior written permission.

HiTeck reserves the right to change features of products, prices, images and text at any time without notice.

For warranty information, please see [www.hiteckmedical.com](http://www.hiteckmedical.com)

