

Women shirt style book

Pattern



91M1

AS-31 pattern
V shape collar
front dart to bottom



91M2

AS-33 pattern
closed collar
front dart to bottom

Pattern

1



91M3

D-AS1-36 pattern
V shape collar
chest dart, front dart to bottom



△ **91A1**

AS-32 pattern
closed collar
chest dart, front dart to bottom

Pattern



92A9

7H pattern,
closed collar, no front dart



91M6

AS-35 pattern,
closed collar, front french dart

Pattern

2



91M4

D-SS-4 pattern, closed collar, front panel
contrast fabric, left & right placket, side panel
joint with front panel



91M5

AS-47 pattern, V shape collar, front panel
joint fabric, side panel joint with front panel
with 0.3cm top stitch

Pattern

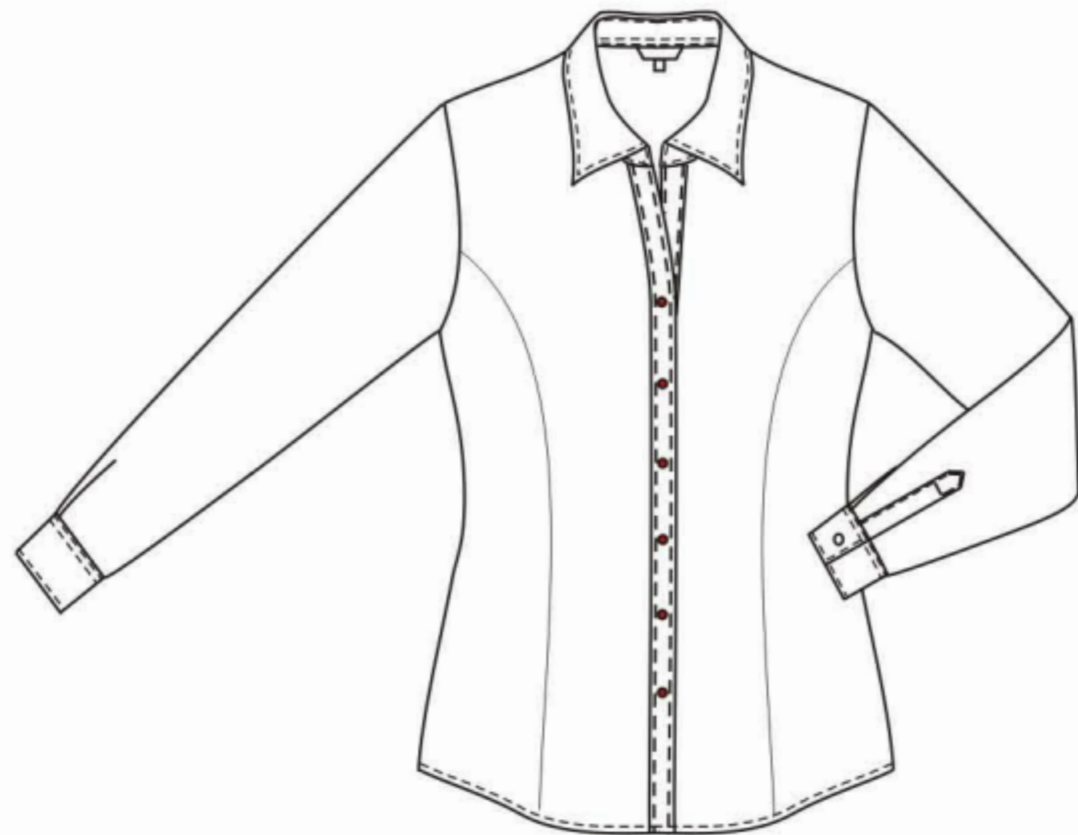

92J4

AS-38 pattern, small V collar
front French dart



9340

AS-33 pattern, closed collar
front 4 darts to bottom

Pattern

3

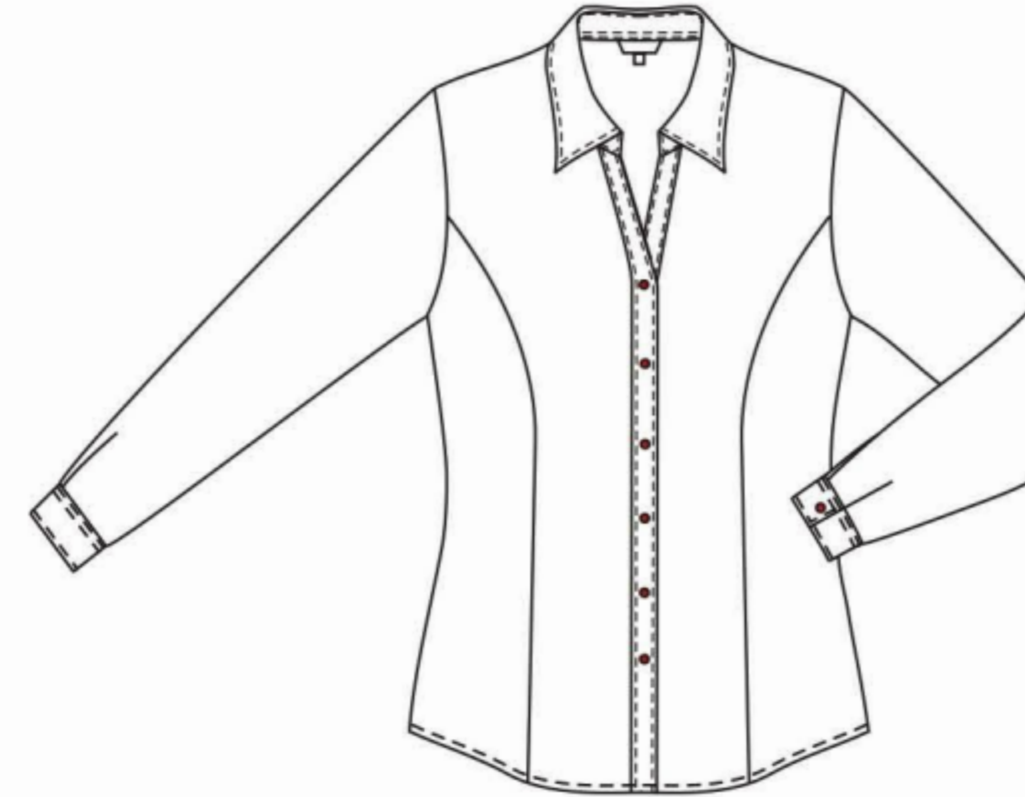

92A8

AS-34 pattern, V collar
front French dart



91N6

D-AS1-37 pattern, small V collar
chest dart, front dart to bottom

Back style

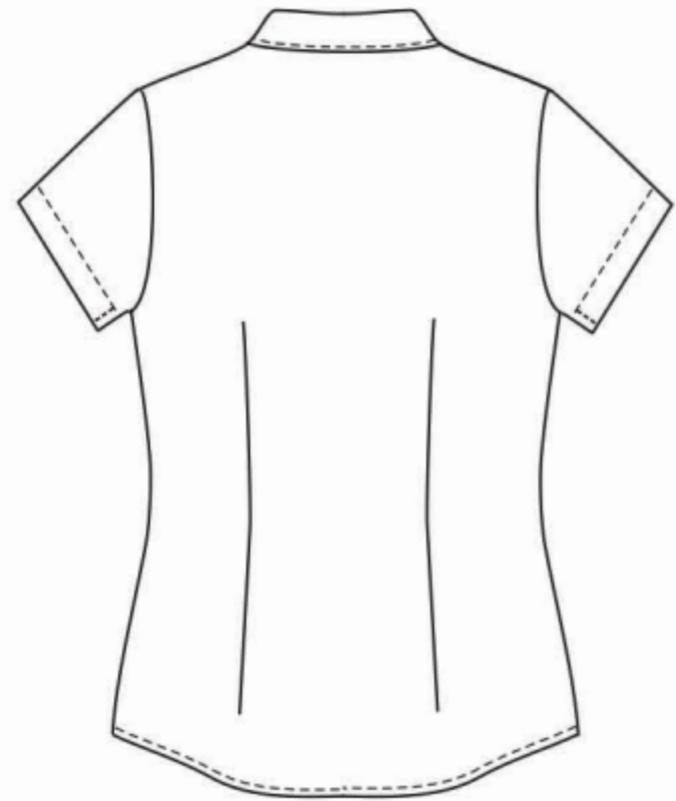

△ 9665

Double darts

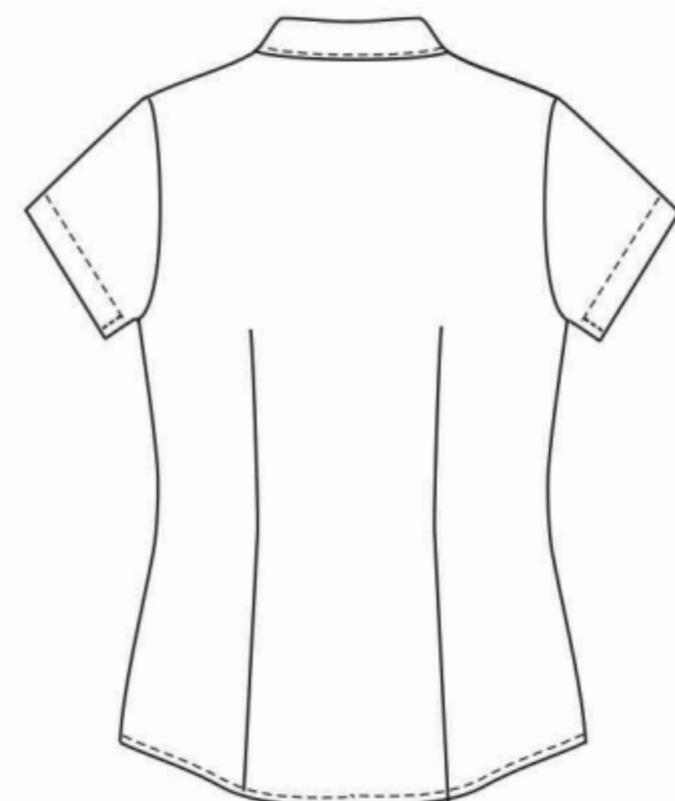

91J4

Double darts to bottom

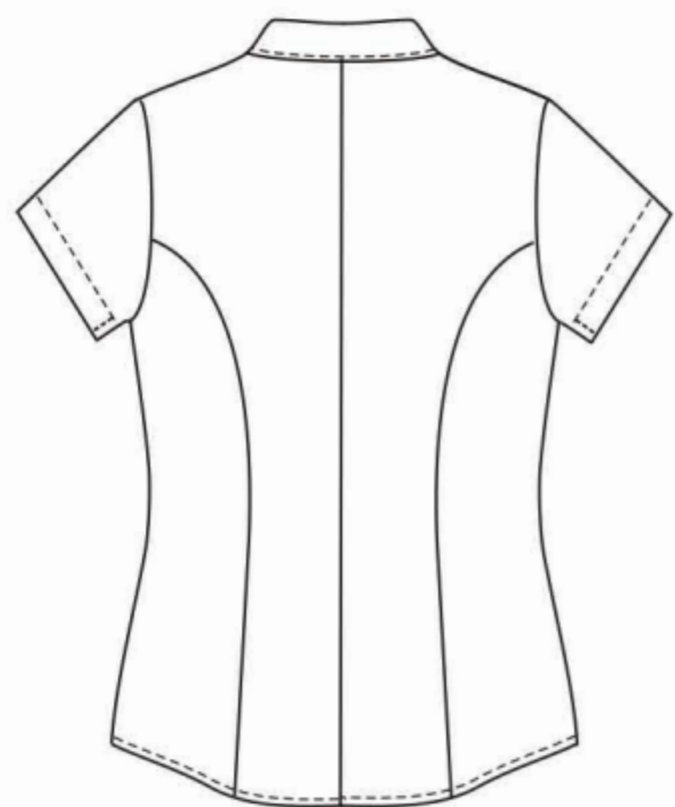

91H9

French seam with center back seam

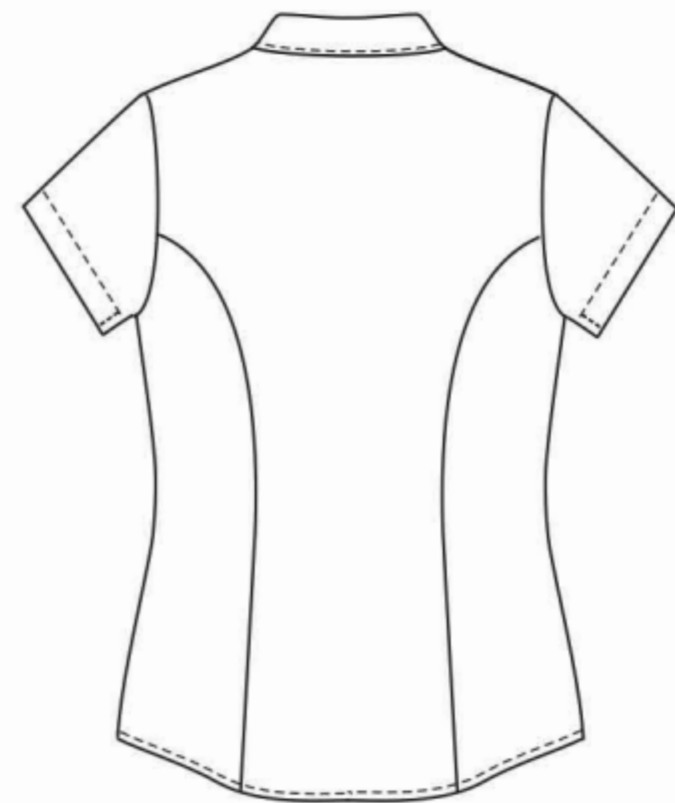

91J1

French seam No center back seam

Back style

4

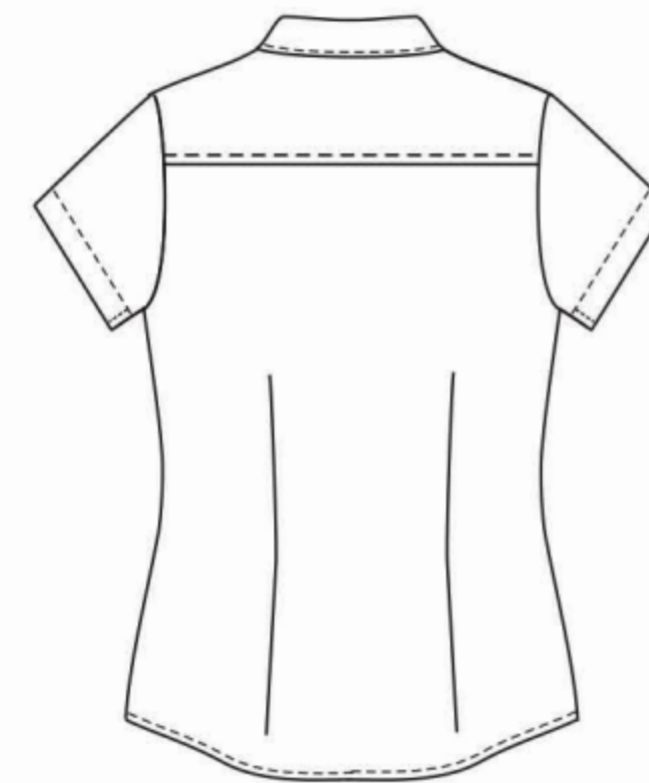

92B1

Only for 7H pattern, Yoke in the back with 0.6cm top stitch, double darts

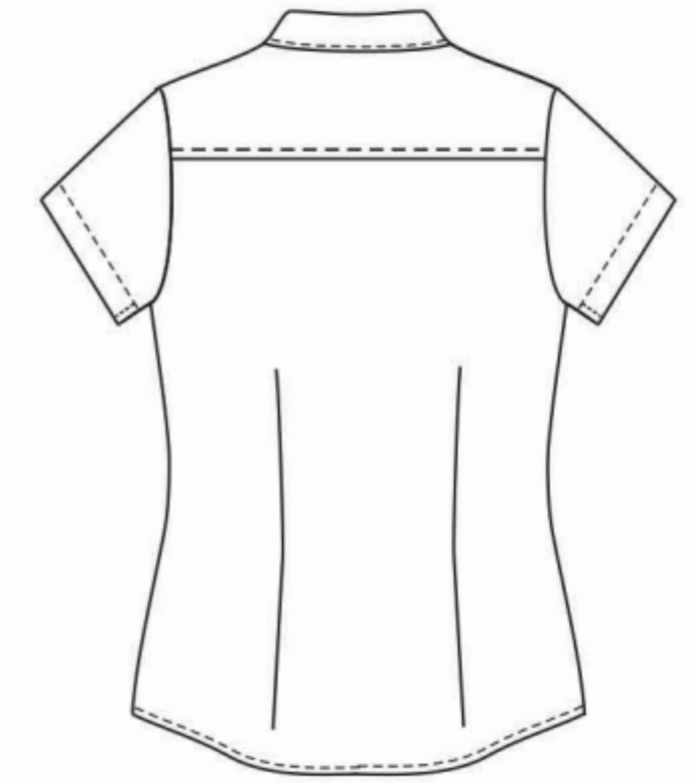

91N8

Yoke in the back double darts

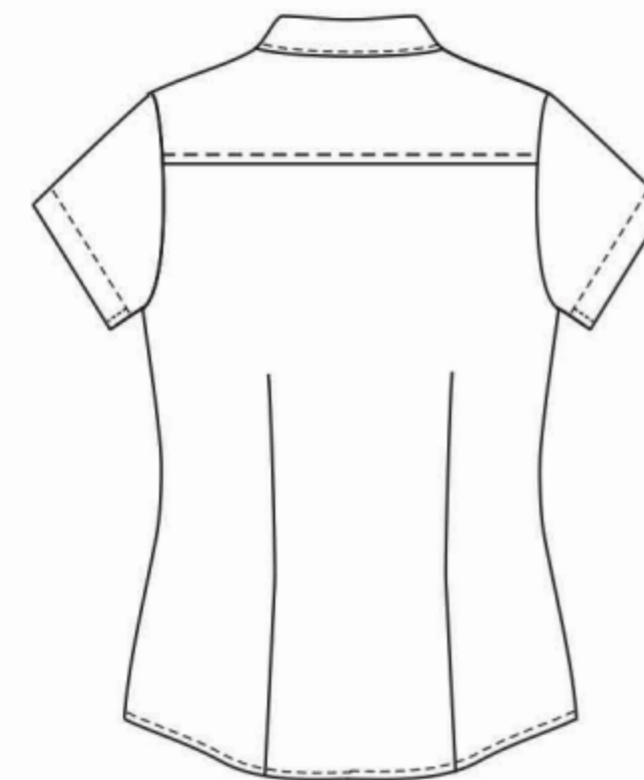

9451

Yoke in the back double darts to bottom

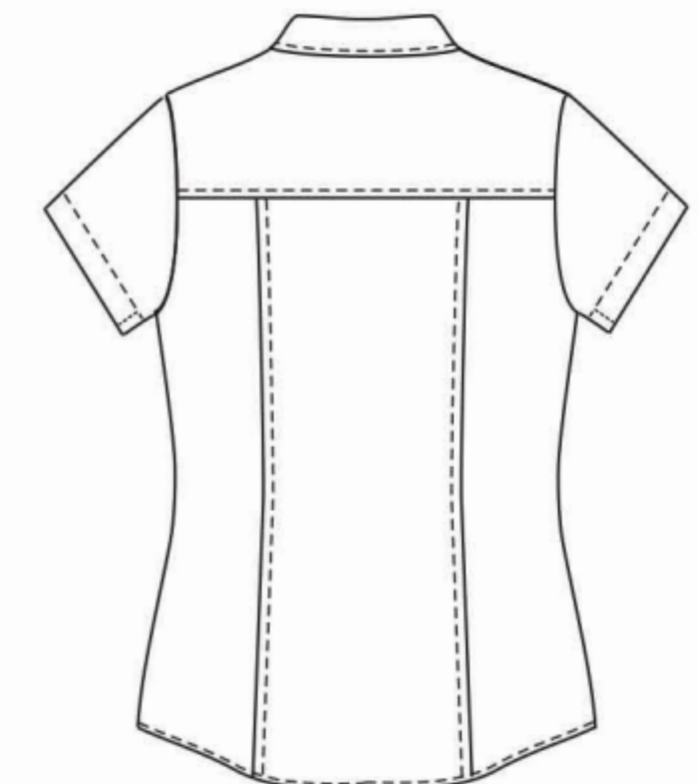

91N1

Only for D-SS-4 pattern and AS-47 pattern, Yoke in the back, back panel joint style

Back style

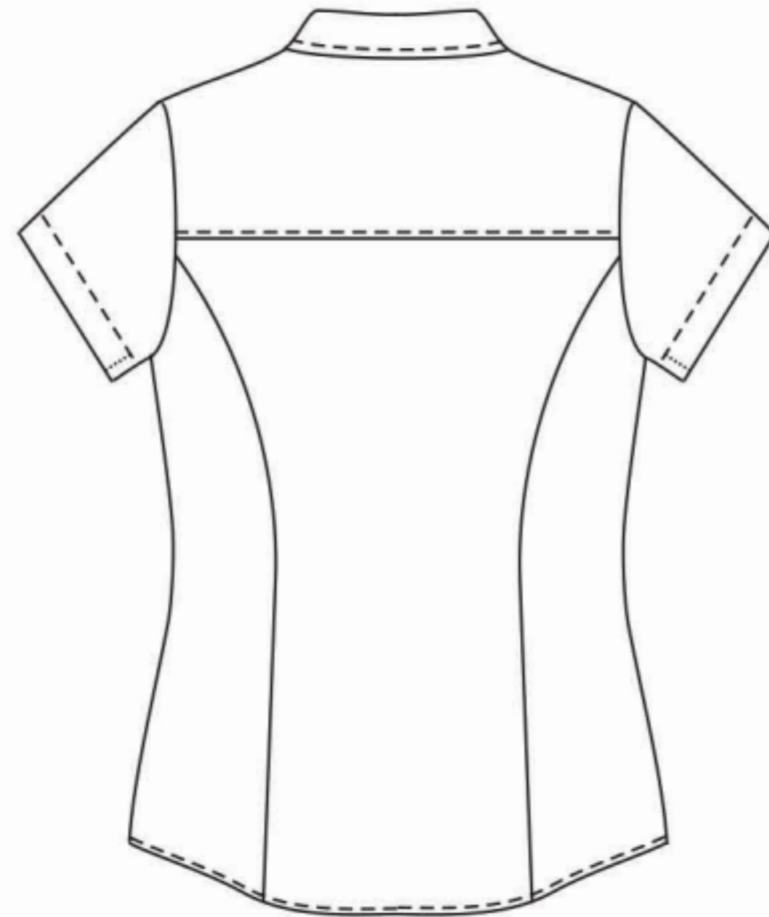

9452

Yoke in the back
French seam, no center back seam

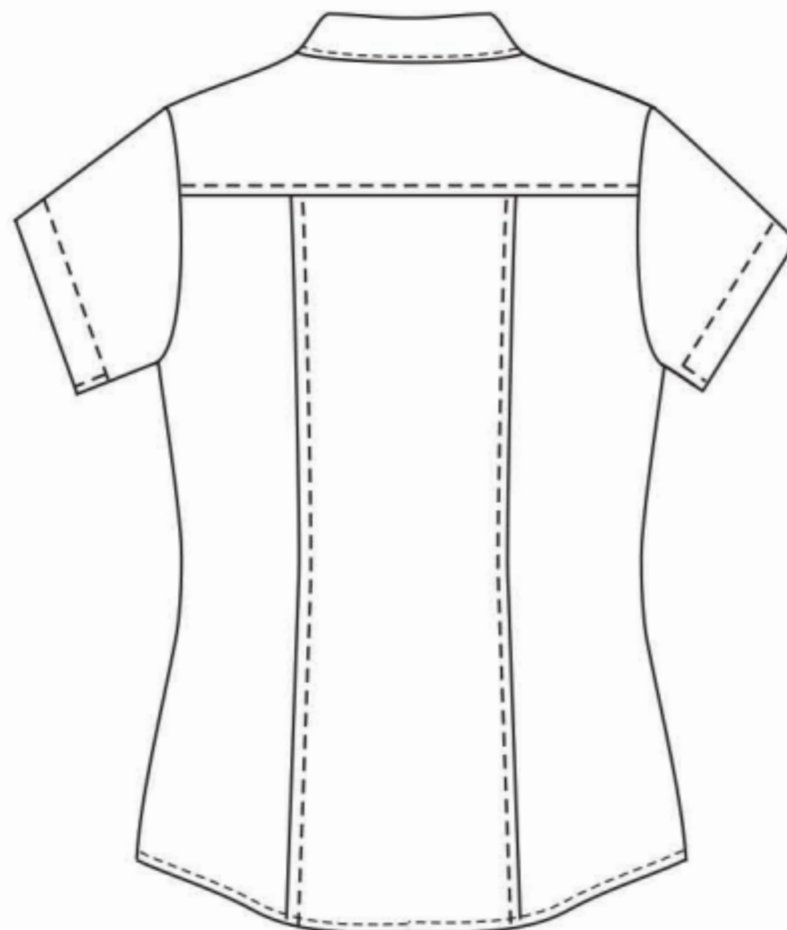

9445

Only for 7H pattern, Yoke in the back
Back panel joint style with 0.3cm top stitch

Placket style

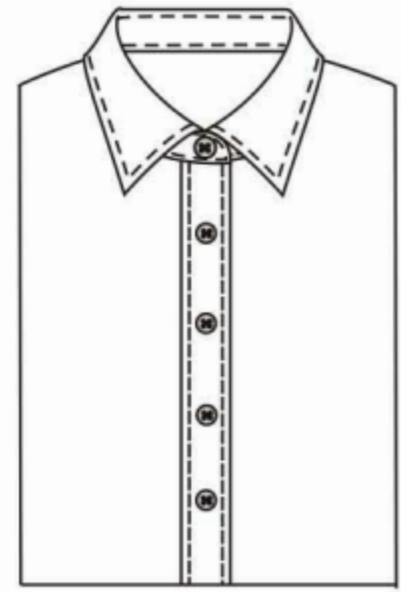

△9801 Placket

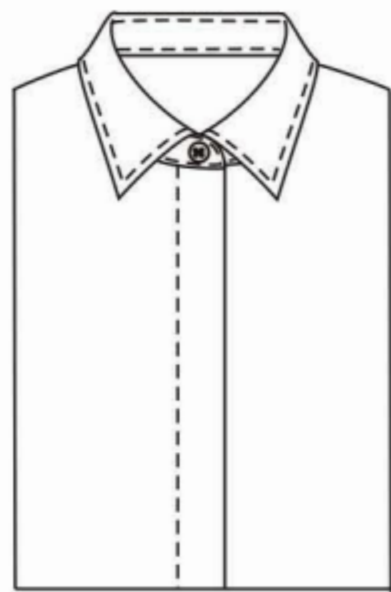

9802 Hidden placket

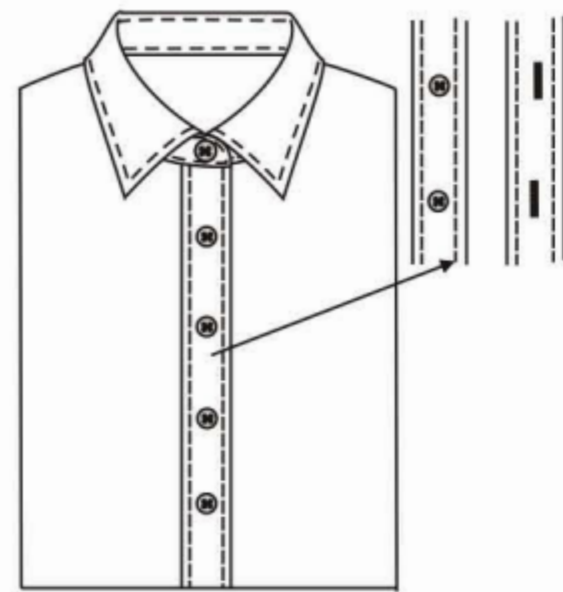

9803 Left&right placket

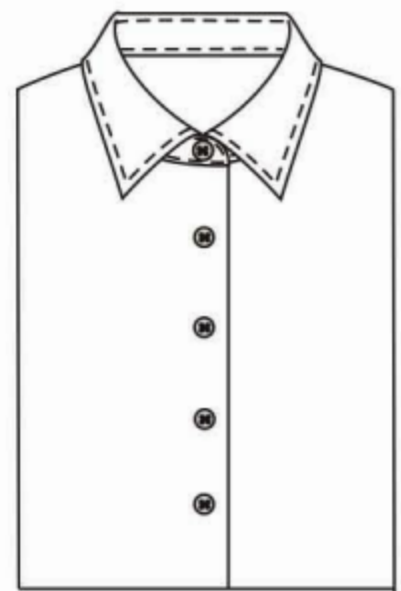

9800 Plain placket

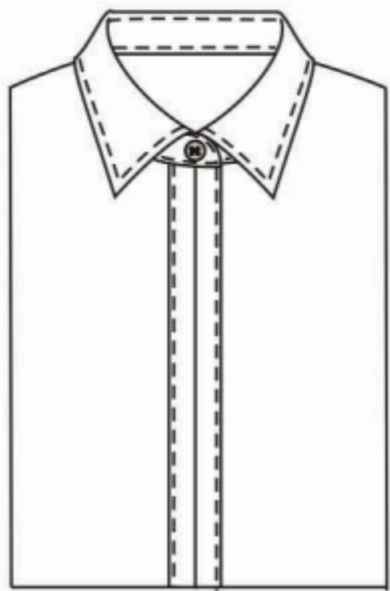

91N7
Pleated hidden placket

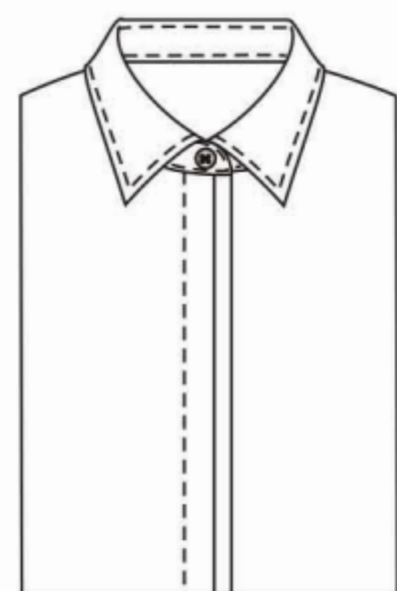

9A26
1/3 hidden placket

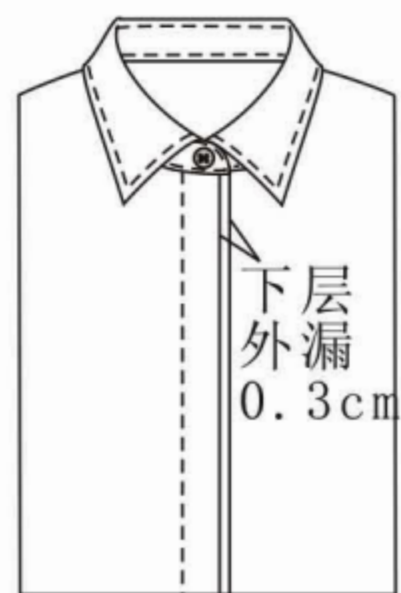

95E5
Exposed hidden placket

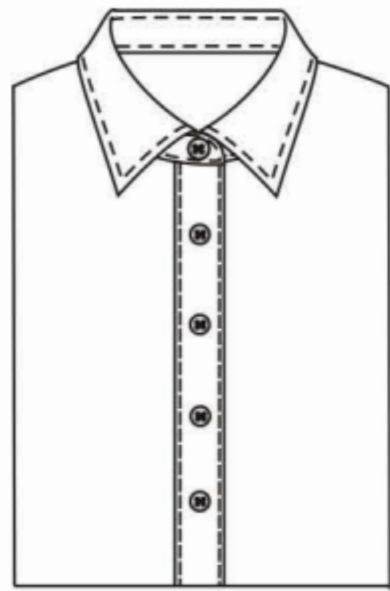

91N5
Left&right binding

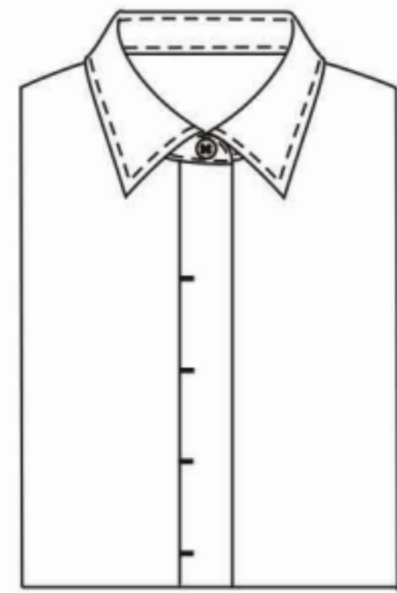

91H4
Exposed hidden placket with bartack

Placket style

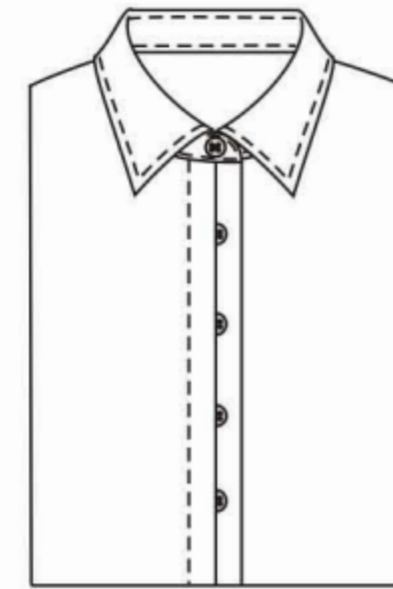

9716
1/2 hidden placket

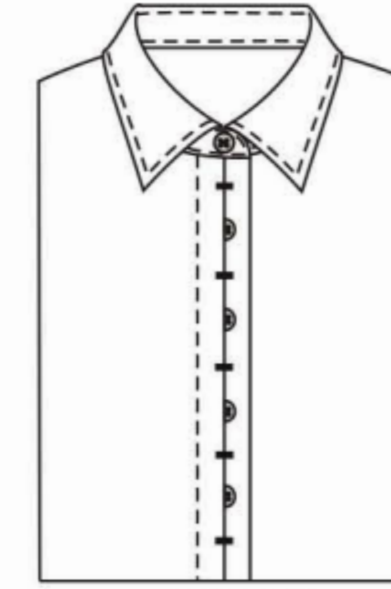

9337
1/2 hidden placket bartack in the middle of each two buttons, bartack is 0.6cm

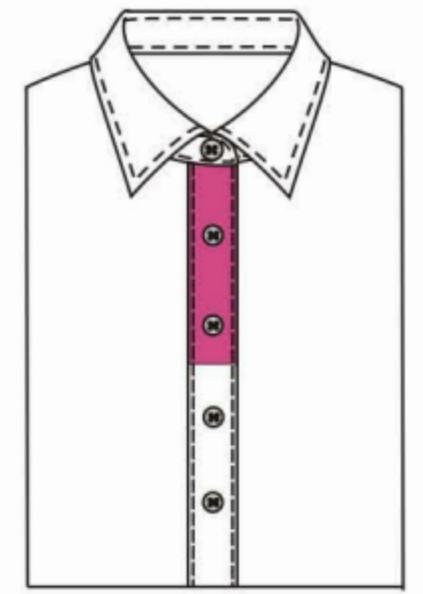

92L3

Left&right placket contrast fabric from top to the middle of the 2nd and 3rd button

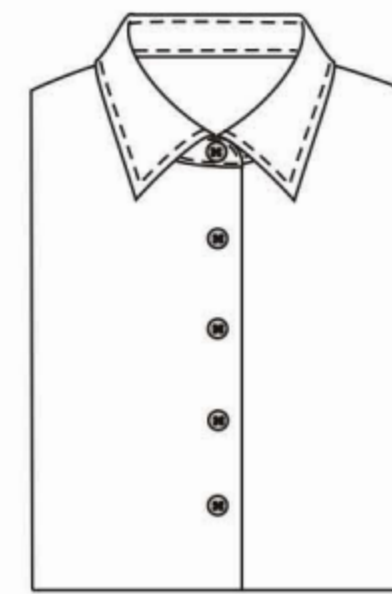

99R4
Left&right plain placket

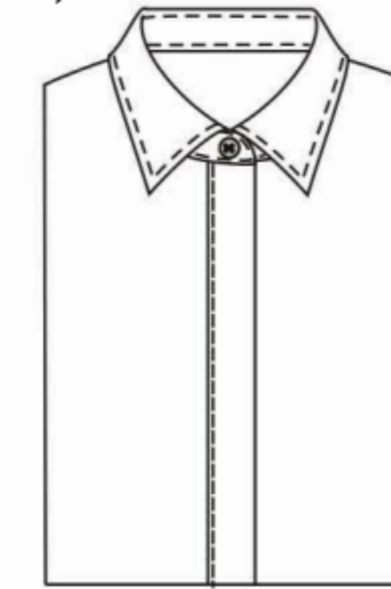

92M7
Binding hidden placket

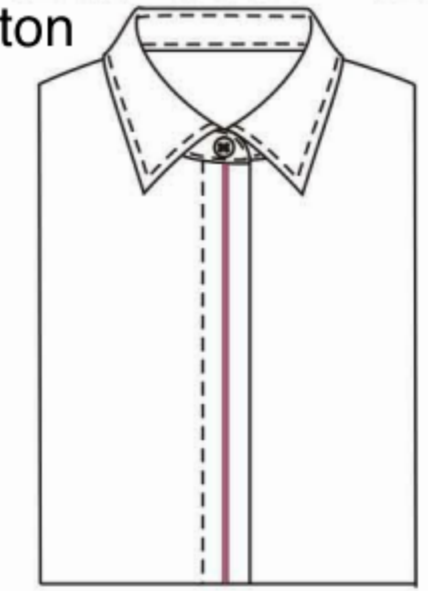

95E4
Hidden placket, add a 0.6cm wide piping in the middle

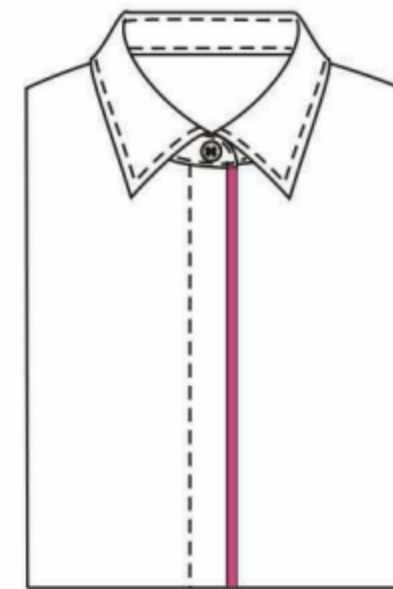

9713
Hidden placket, the upper side contrast 0.4cm piping

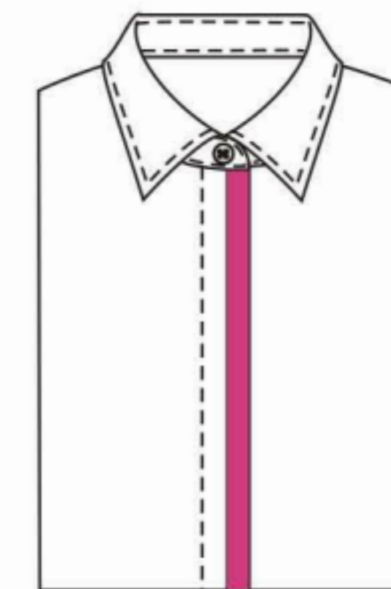

9606
Hidden placket, 1/2 wide contrast fabric

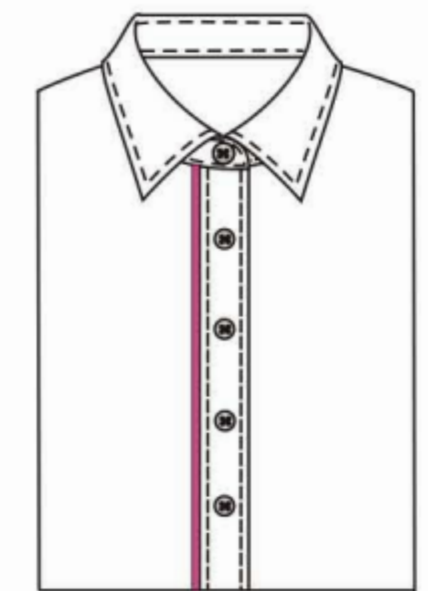

9438
0.3cm wide piping inside right placket

Placket style

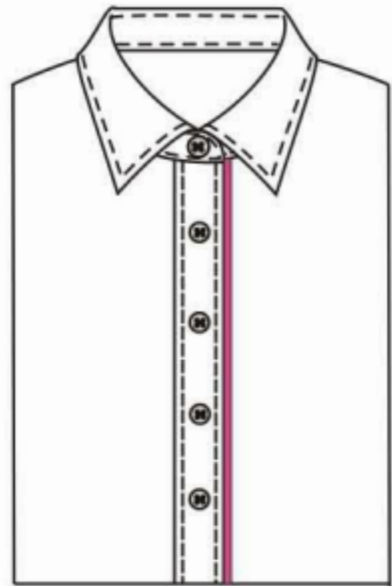

9439

The left placket with 0.3cm piping

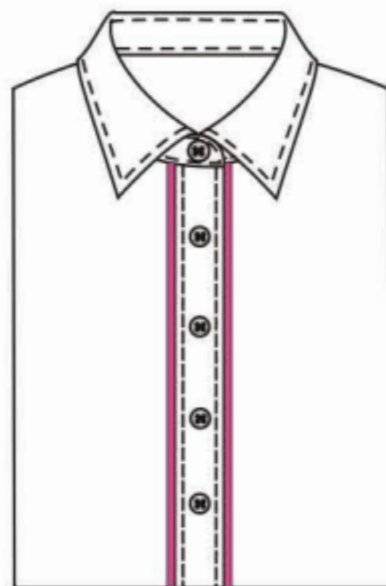

9794

The left & right placket with 0.3cm piping

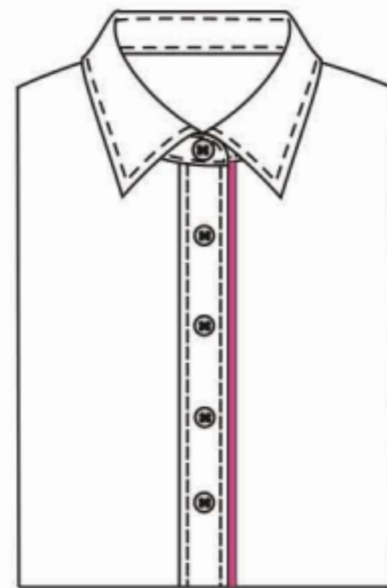

9333

The right placket with 0.3cm piping

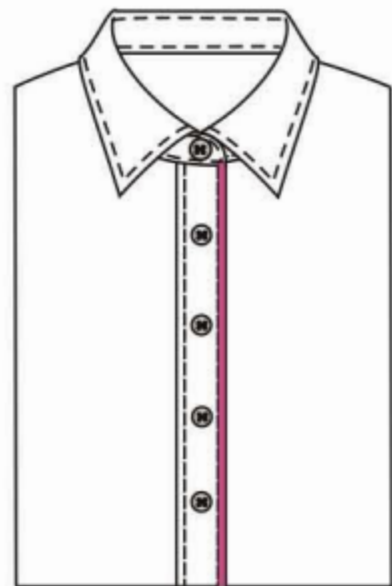

97E1

The left & right edge with 1cm contrast piping-

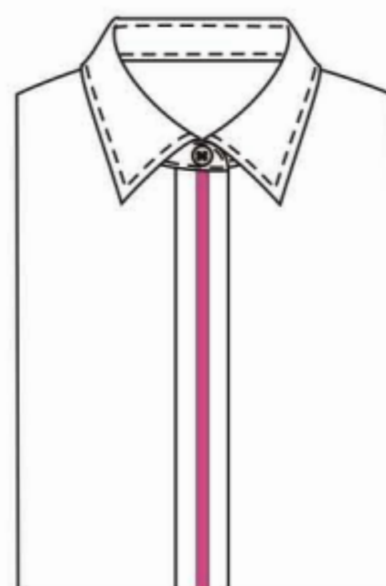

99P4

Exposed hidden placket with decoration piping in the middle

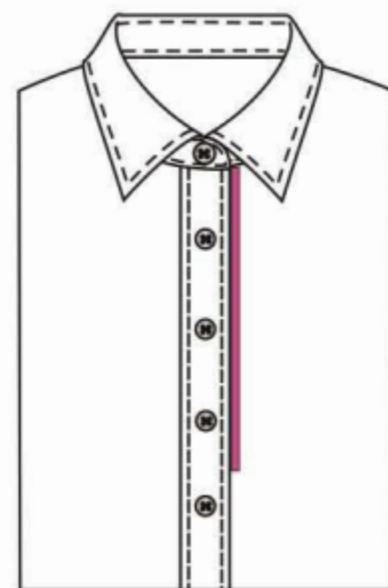

9881

Left placket inside add piping, from top to the middle of 3rd and 4th button-

Front style



9203

Gusset on right chest,
two pleats, 1cm size, 1cm distance



9204

Gusset on left&right chest,
two pleats, 1cm size, 1cm distance

Front style

8



91F9

Lace on left&right panel,
lace is 2.3cm wide

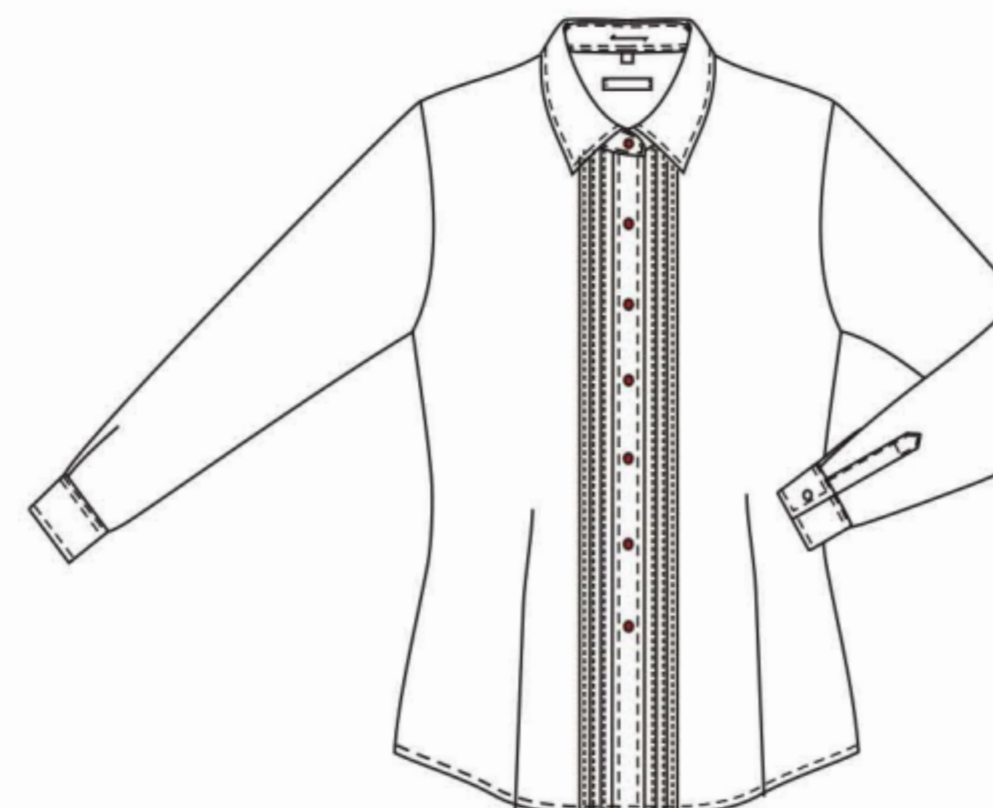

91F8

3 pleats on left&right panel,
0.5cm size, 1cm distance

Front style



9243

Front wave fold (1cm pleat, distance between two pleats is 0.5cm)



92E7

Right placket with lace, lace is 0.8cm wide

Front style

9



9336

Front shoulder with patch gusset

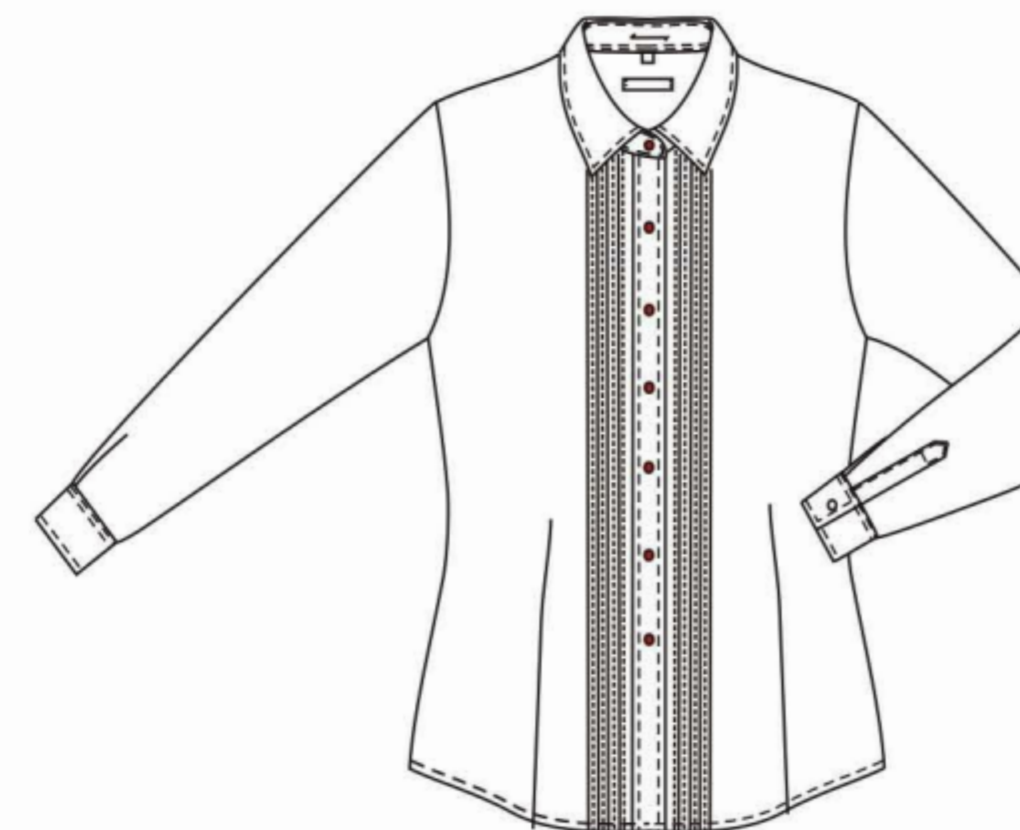

9335

Left&right front with 4 pleats (0.3cm pleat, distance between two pleats is 0.5cm)

Front style

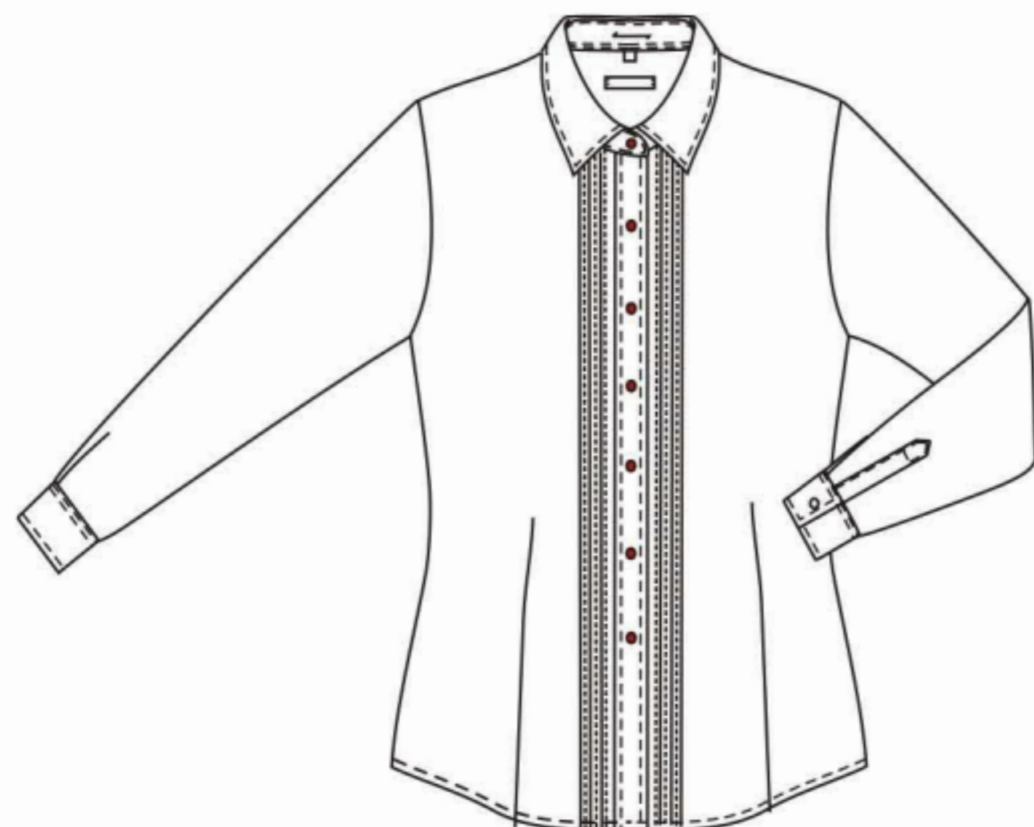

9345

Three pleats on left&right panel
1st pleat is 1cm from placket
0.3cm pleat, distance between is 0.5cm

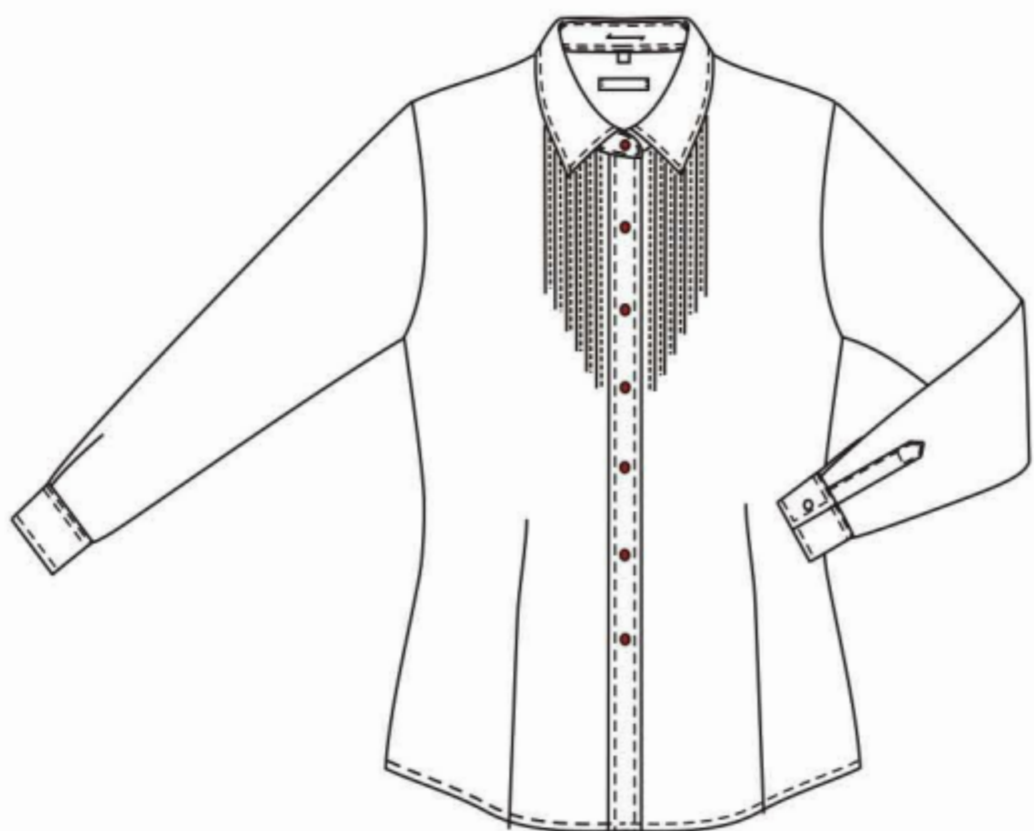

9334

Six pleats on left&right panel 0.2cm
pleat, distance between is 1.5cm

Front style

10



9339

Left &right panel with four decoration stripes
stripe is 2cm wide, the longest is 23cm, the other three
is 21cm, 19cm, 17cm



9297

Left&right panel with lace
The front style can only be binding style

Front style

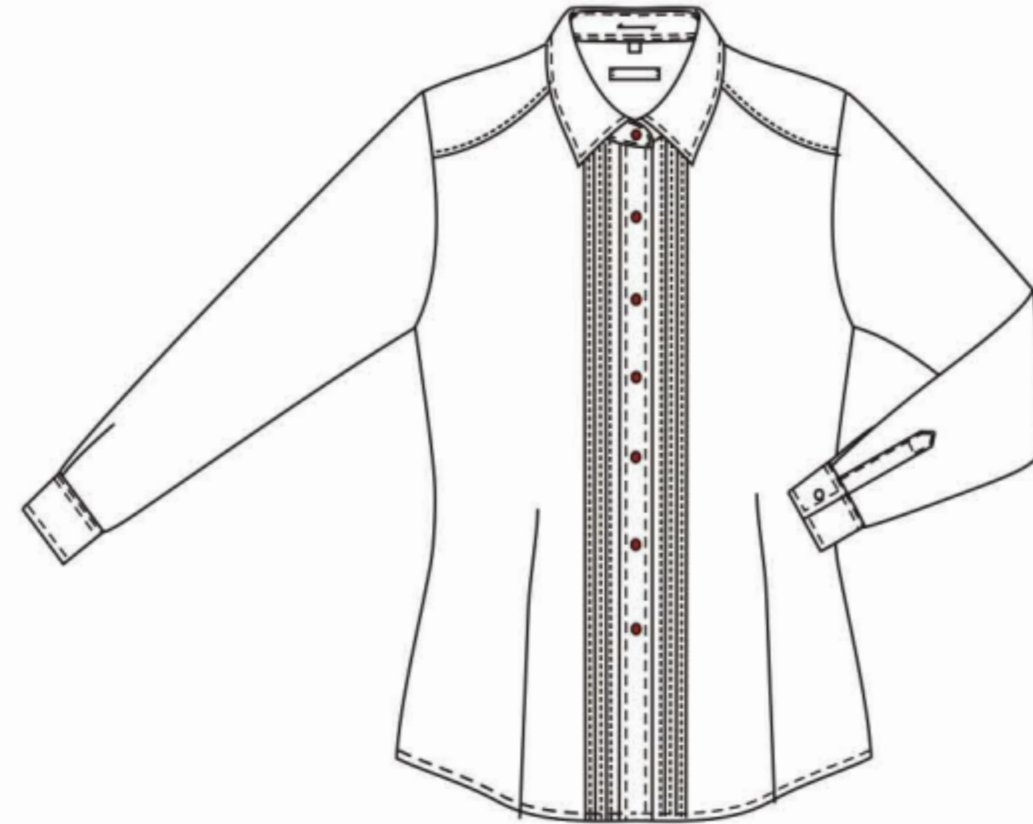

9367

Front shoulder with patch gusset Three pleats on left&right panel
1st pleat is 1cm from placket
0.3cm pleat, distance between is 0.5cm

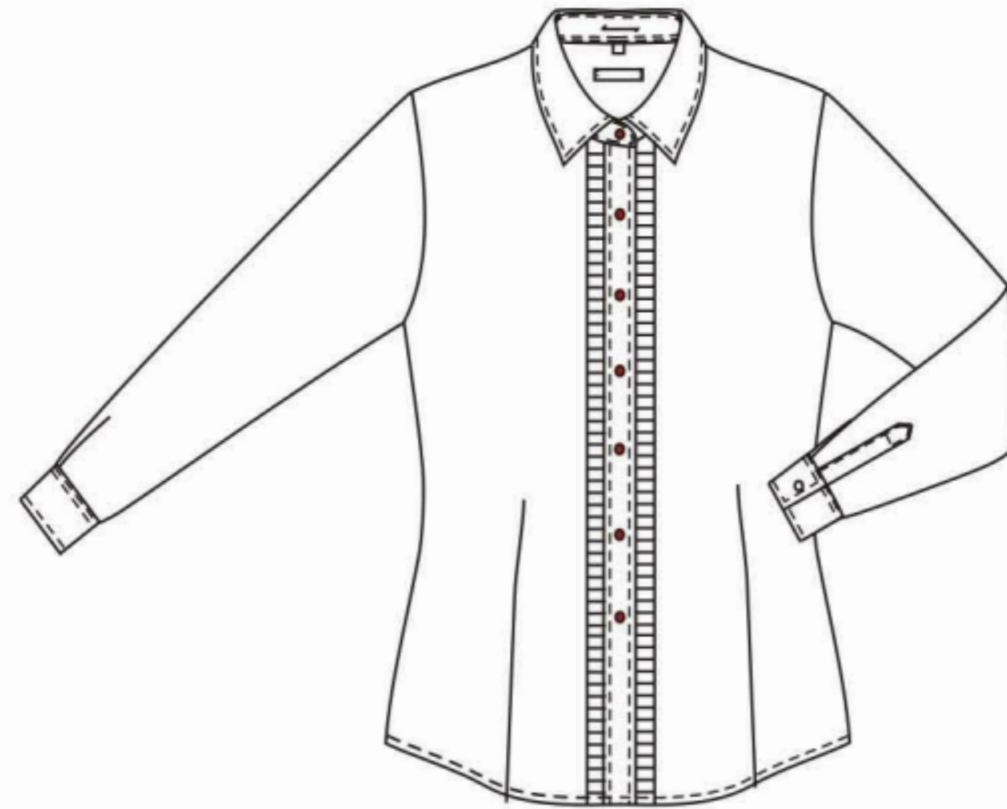

91G1

Front pleat 1cm wide
2.0cm distance
2.5cm lace on left&right panel

Front style

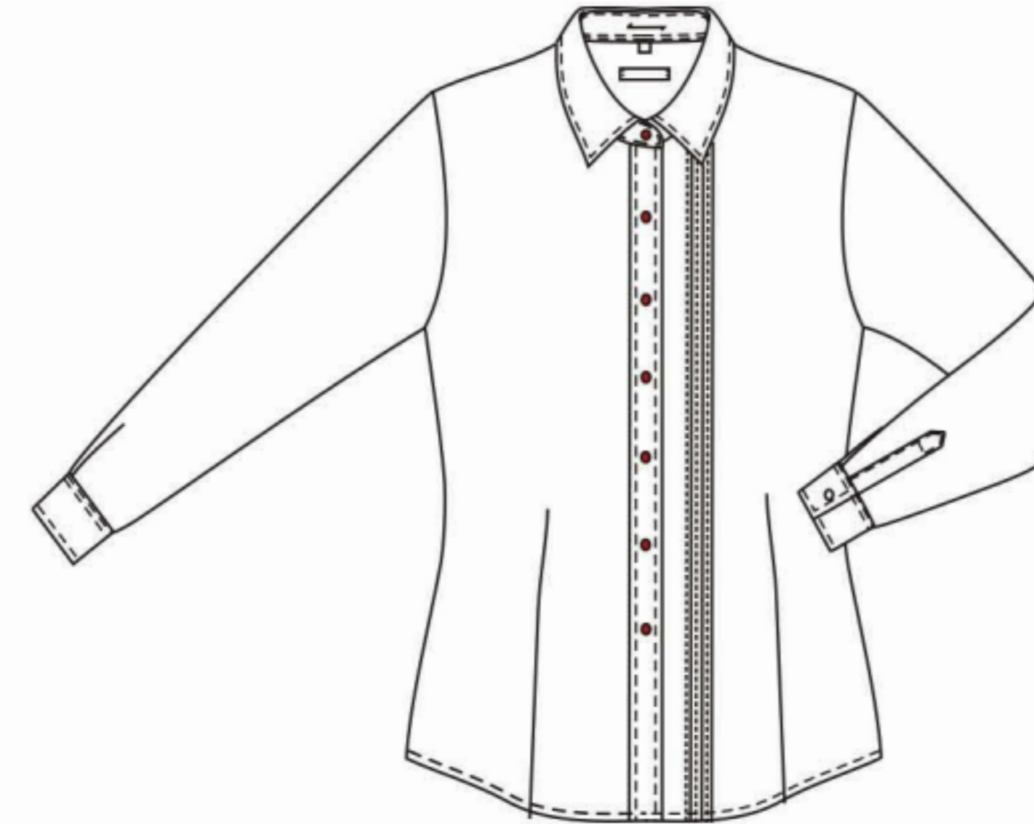

95E2

Three pleats on left panel
1cm pleat, distance between is 2cm
1st pleat is 4.5cm far from the placket

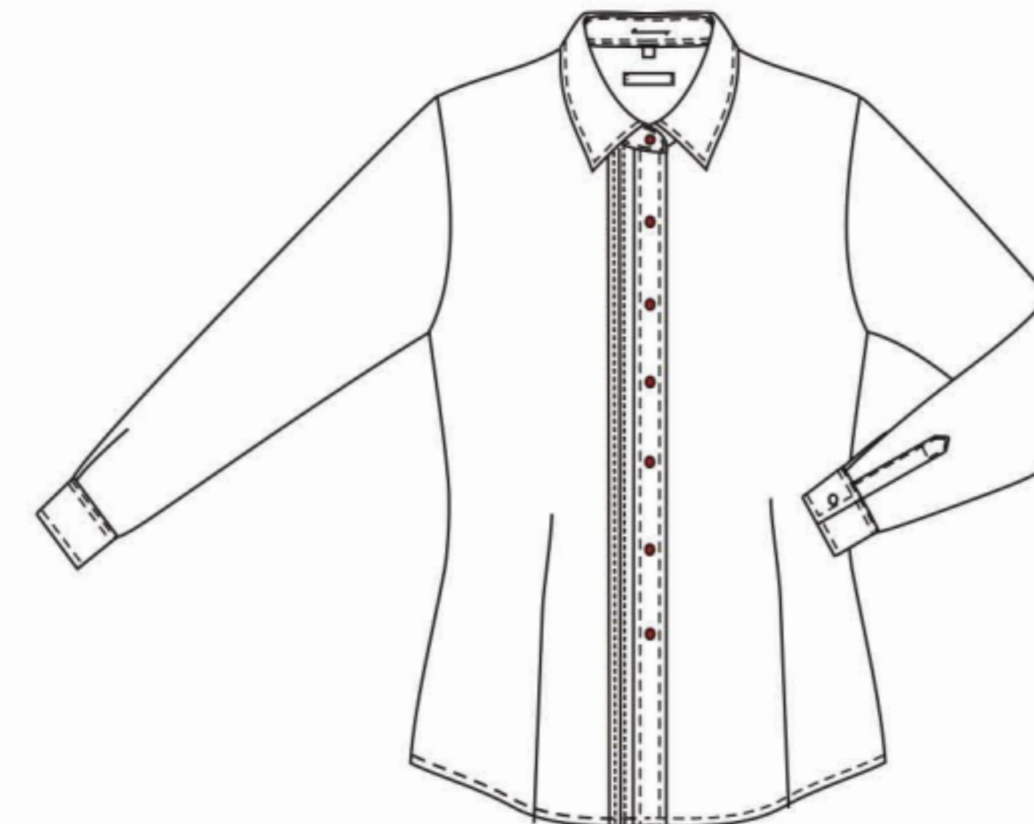

92J7

Two pleats on the right panel
0.7cm pleat, distance is 0.8cm
1st pleat is 1.4cm from placket

Front style

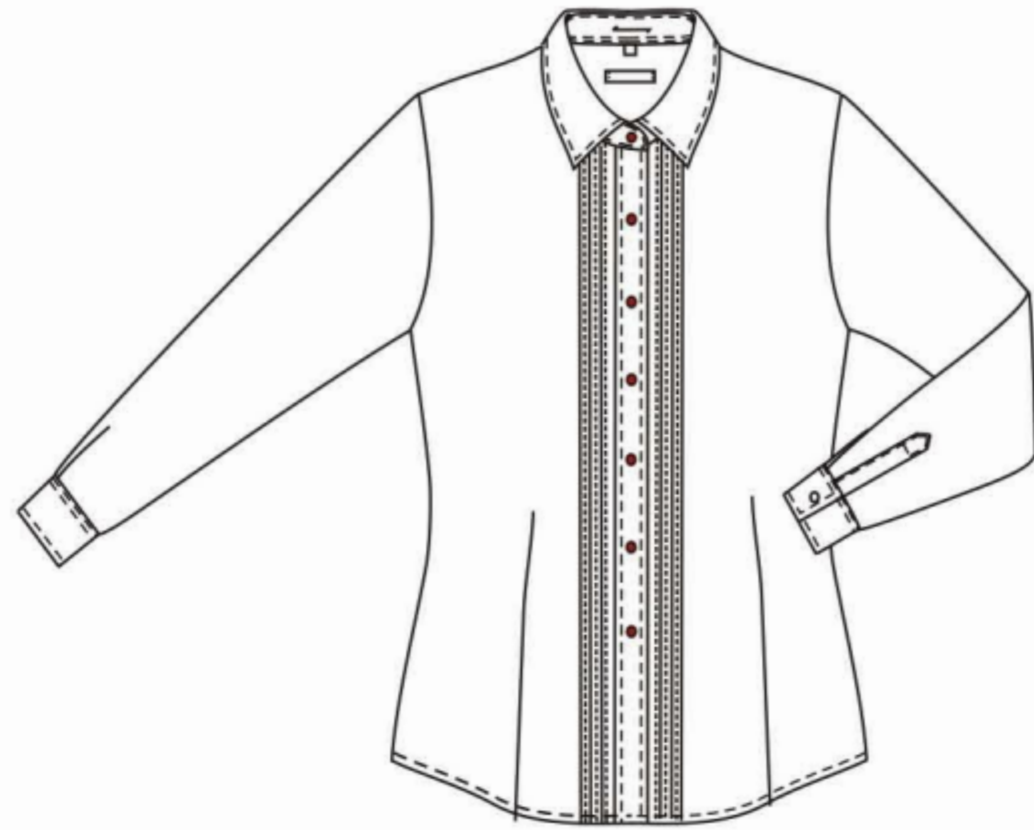

9345

Three pleats on left&right panel
1st pleat is 1cm away from placket

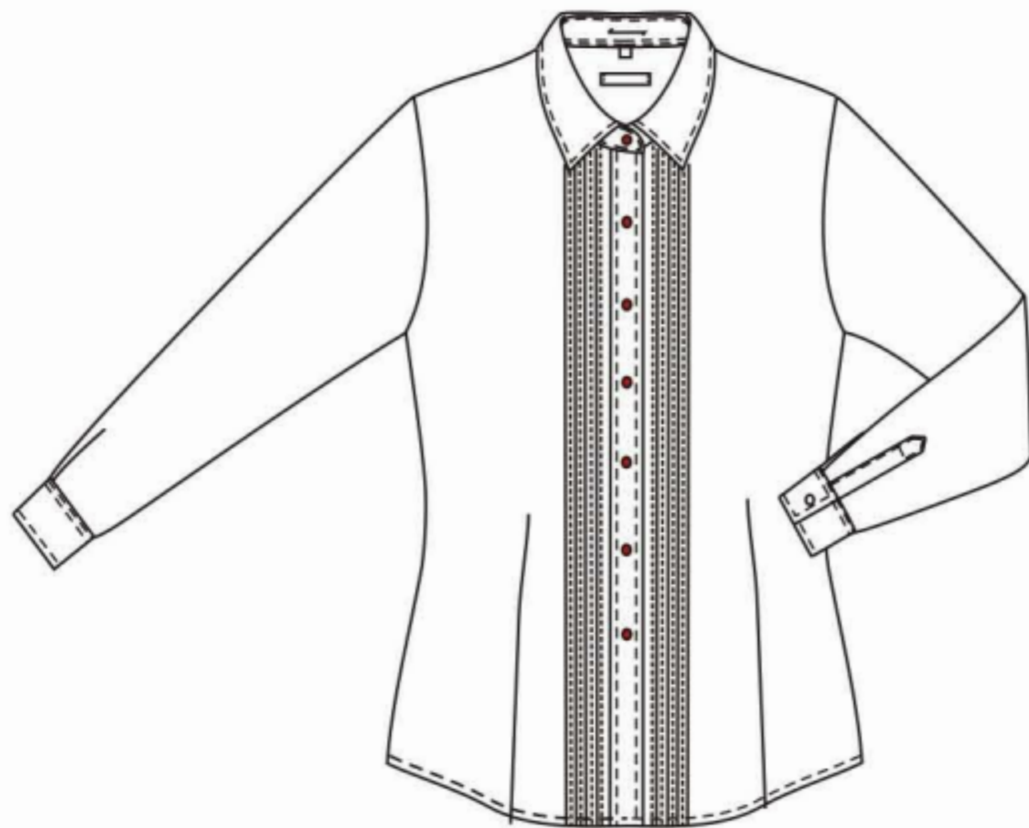

91F5

Five pleats on left&right panel

Cuff style

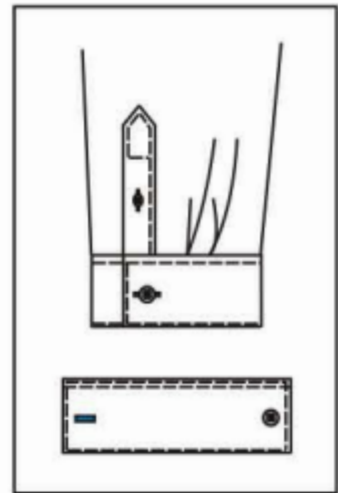

△9510

Square cuff
one button one
buttonhole

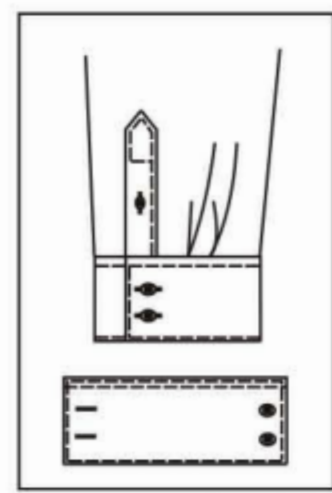

9511

Square cuff
two buttons two
buttonholes

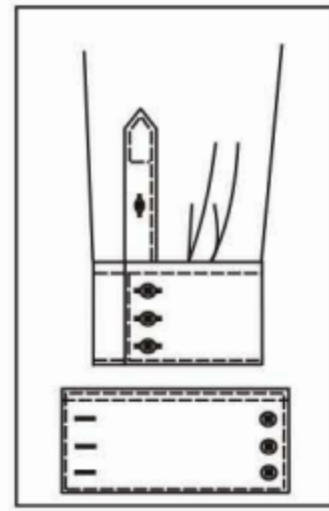

9512

Square cuff
three buttons
three buttonholes

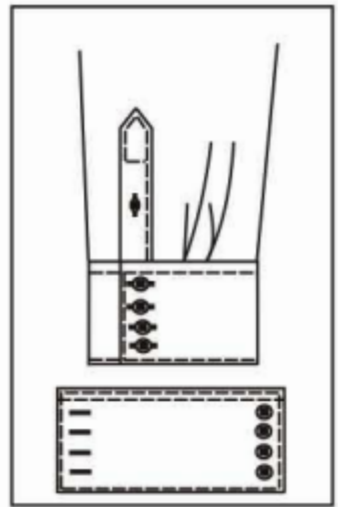

92A4

Square cuff
four buttons
four buttonholes

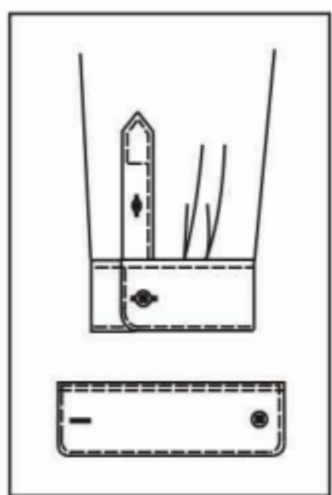

9513

Round cuff
one button one
buttonhole

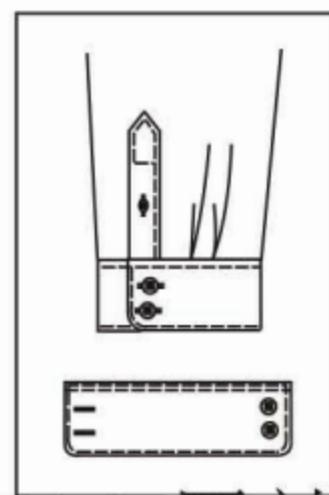

9514

Round cuff
two buttons two
buttonholes

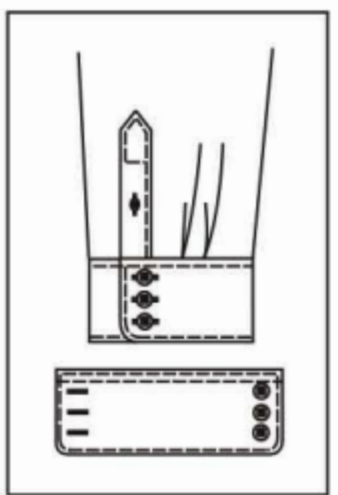

9515

Round cuff
three buttons
three buttonholes

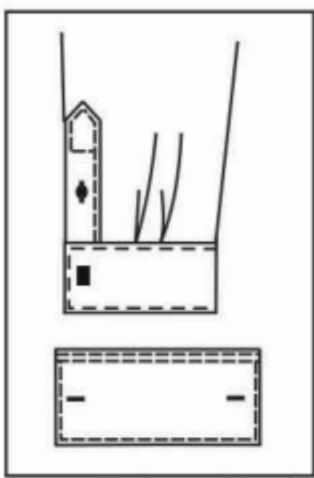

9893

French single straight
cuff two buttonholes

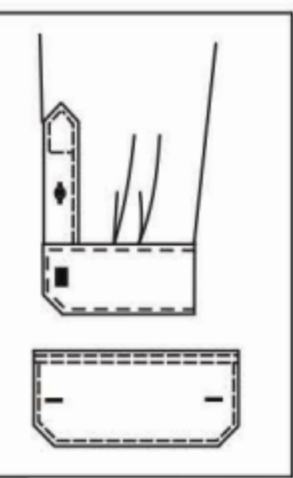

95E0

French single
hexagon cuff two
buttonholes

Cuff style

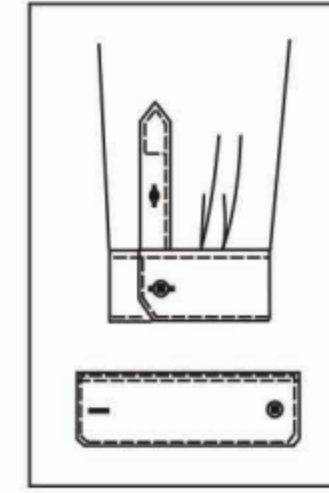

9516

Hexagon cuff
one button
one buttonhole

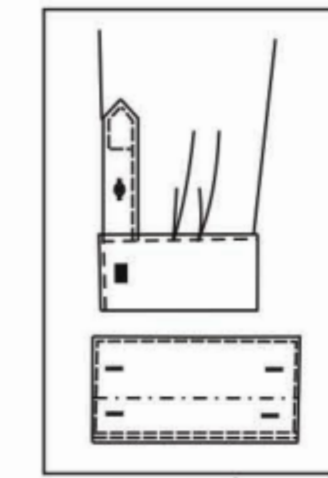

9521

French cuff
four buttons
four buttonholes

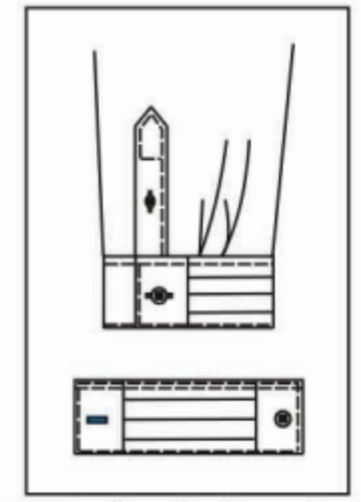

9312

Straight cuff with one button
one buttonhole, 3 pleats in the
middle on a contrast fabric

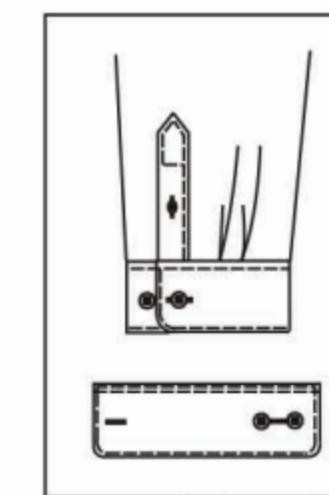

91P0

Round cuff
two buttons
two buttonholes

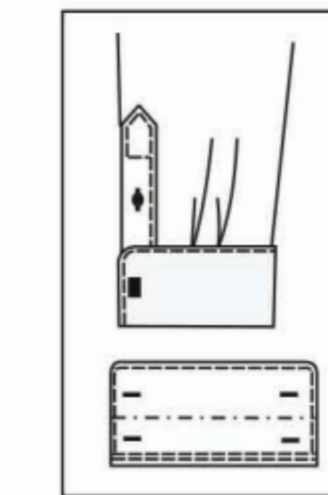

9519

French round cuff
four buttonholes

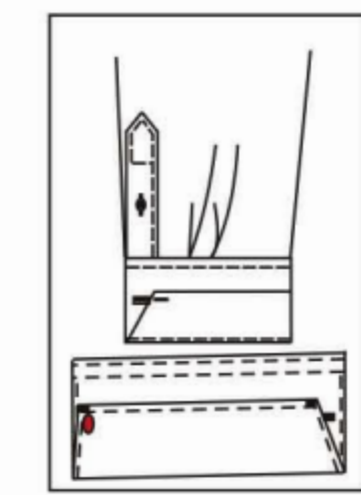

91L1

Half French straight cuff
one button one buttonhole

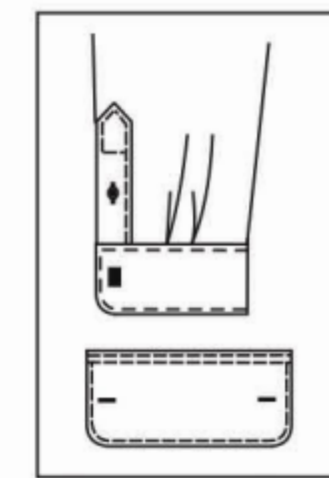

99A6

French single round
cuff two buttonholes

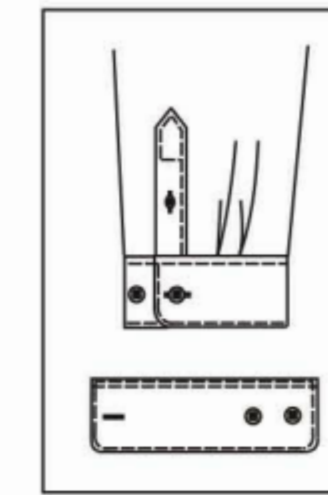

9777

Round cuff two buttons
one buttonhole

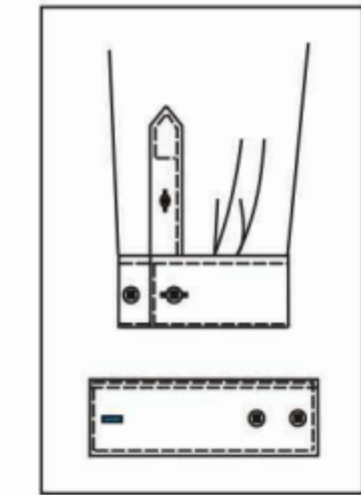

9886

Straight cuff
two buttons one buttonhole

Cuff style

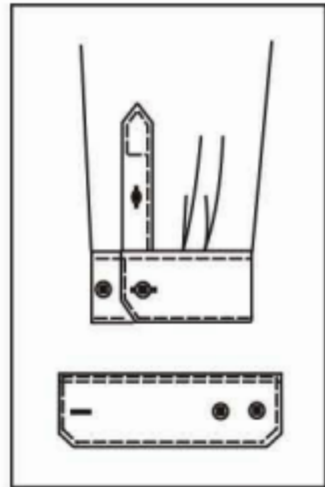

92K4
Hexagon cuff
two buttons one buttonhole

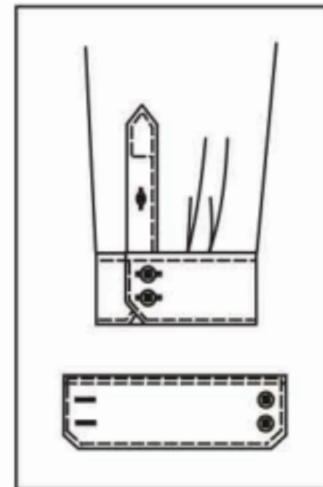

9446
Hexagon cuff
two buttons
two buttonholes

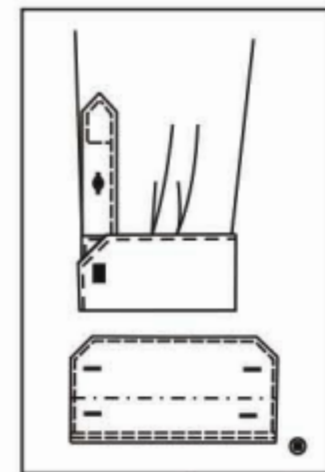

9520
French hexagon cuff
four buttonholes

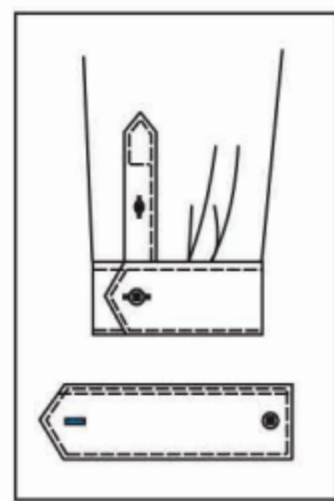

9774
Pointed cuff
one button
one buttonhole

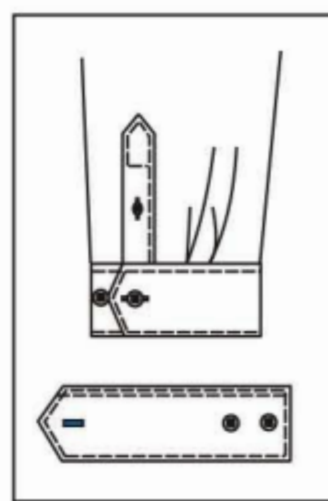

94M9
Pointed cuff
two buttons
one buttonhole

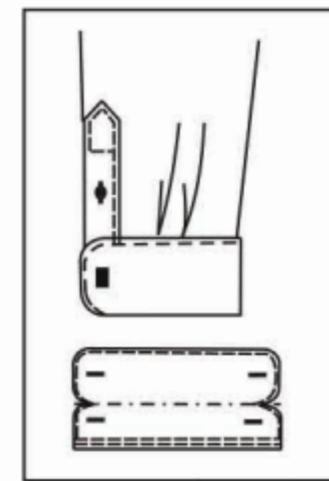

97E3
French round cuff
four buttonholes

Short cuff style

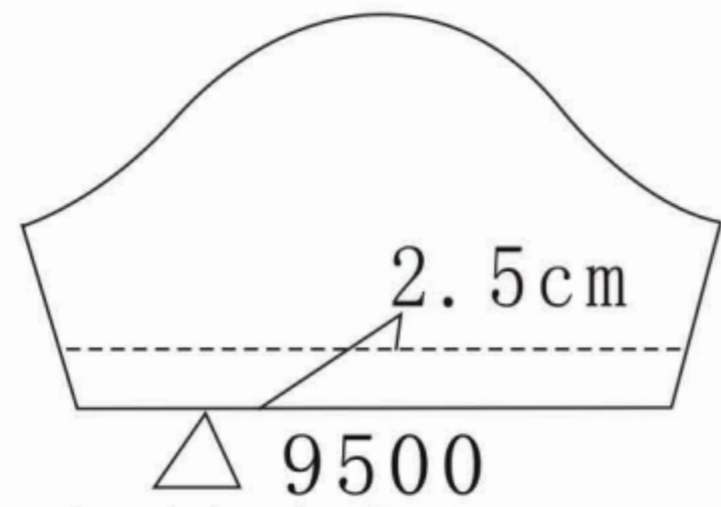

Short sleeve plain 2.5cm

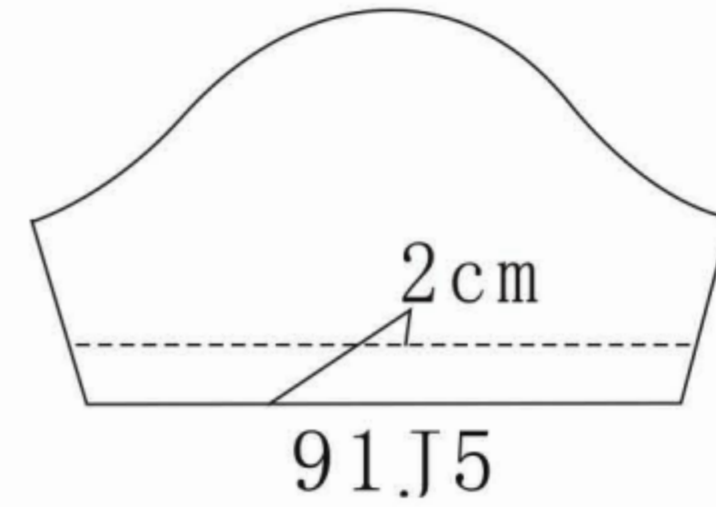

Short sleeve plain 2.0cm

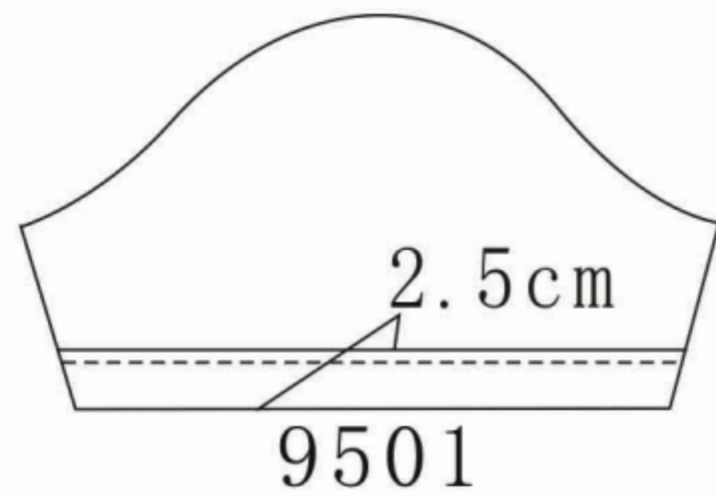

Short sleeve imitation hem

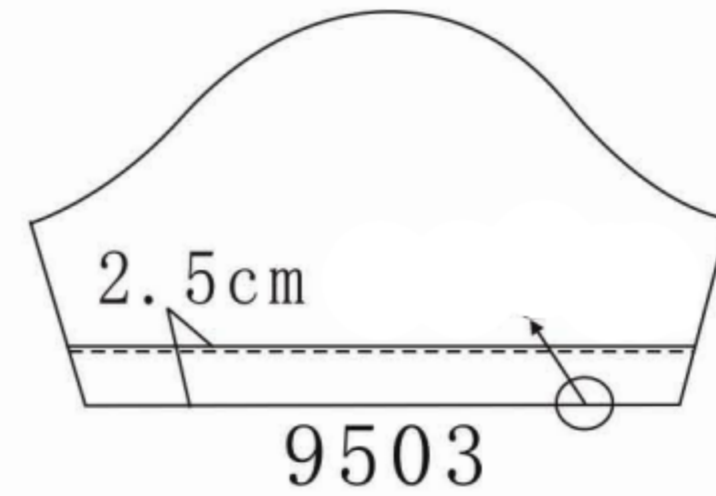

Short sleeve with cuff

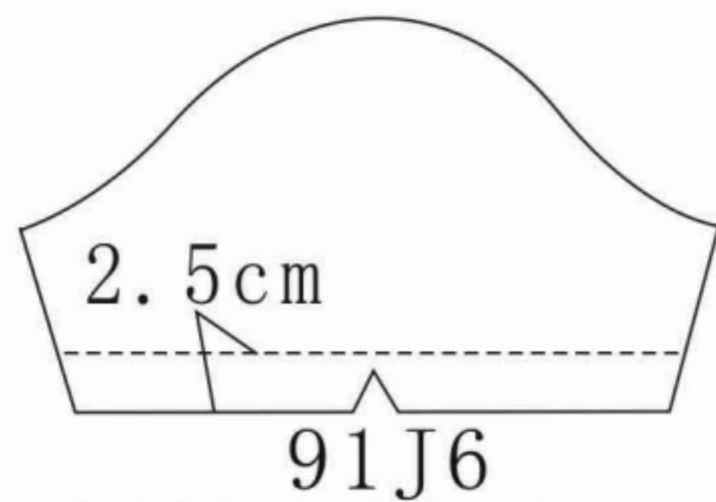

Plain short sleeve
triangle opening without button

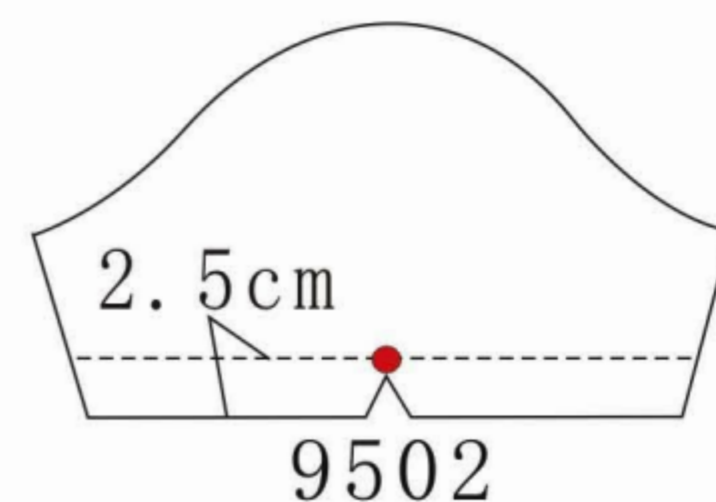

Plain short sleeve
triangle opening with one button

Short cuff style

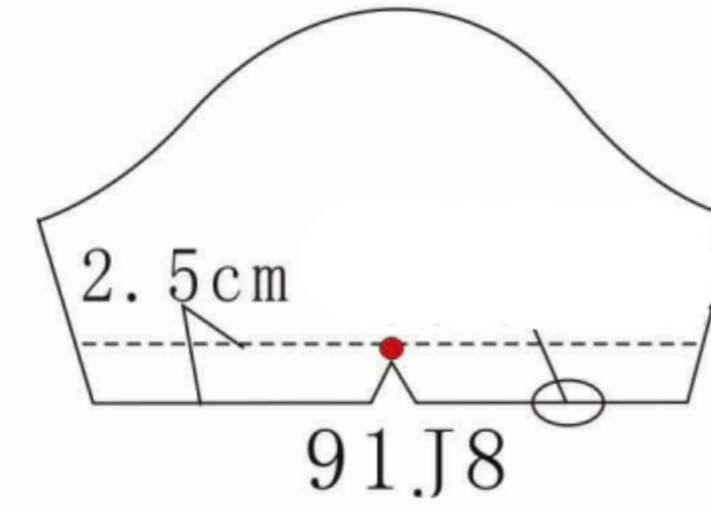

Short sleeve with inner cuff
triangle opening with one button

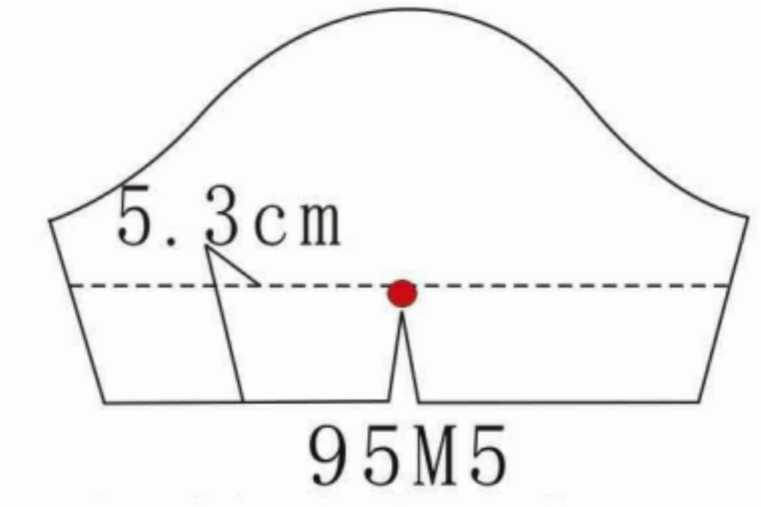

Plain short sleeve,
triangle opening with one button

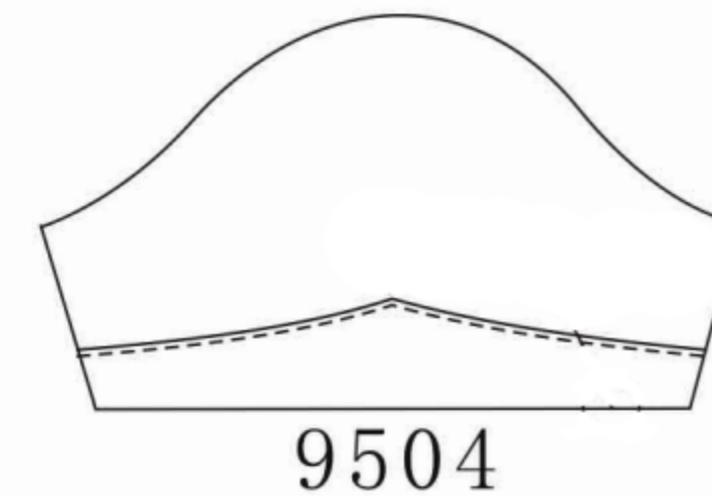

Short sleeve with
horse-hoof shaped cuff

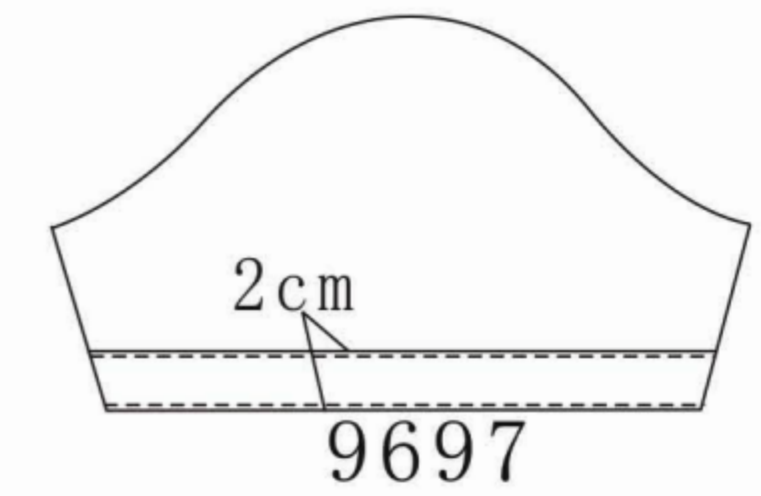

Short sleeve with 2.0cm exterior hem
0.1cm top stitch

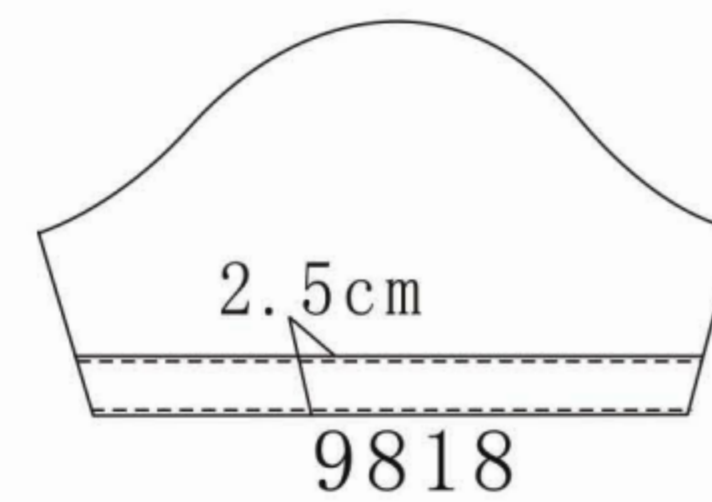

Short sleeve with 2.5cm exterior hem
0.1cm top stitch

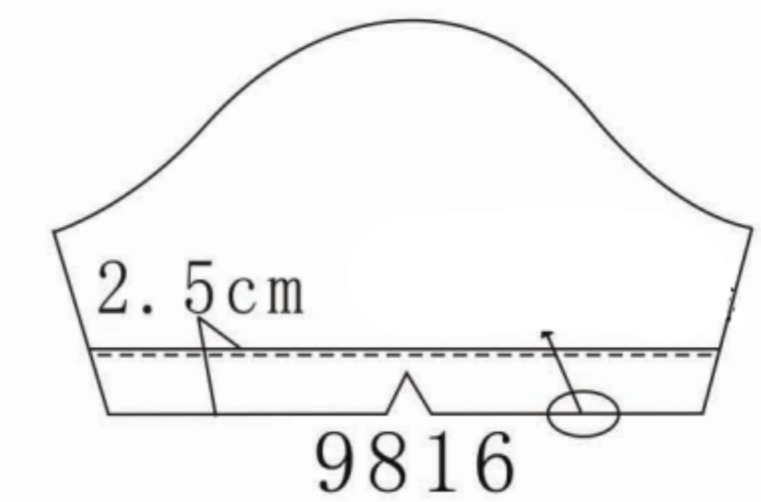

Short sleeve with 2.5cm exterior hem
triangle opening without button

Short cuff style

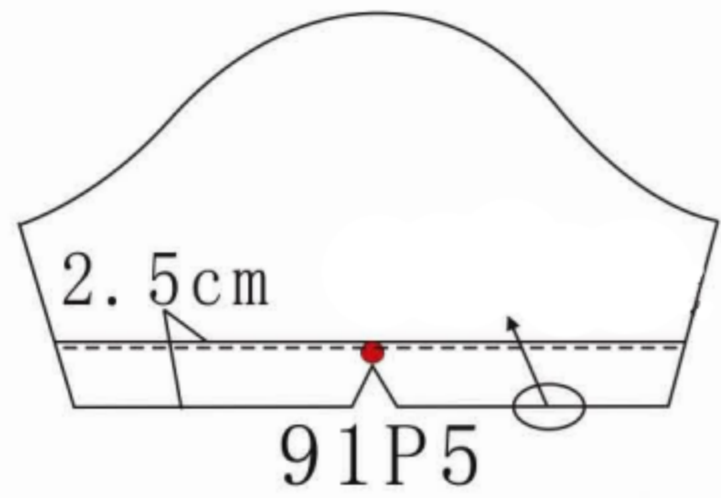

Short sleeve with 2.5cm exterior hem triangle opening with one button

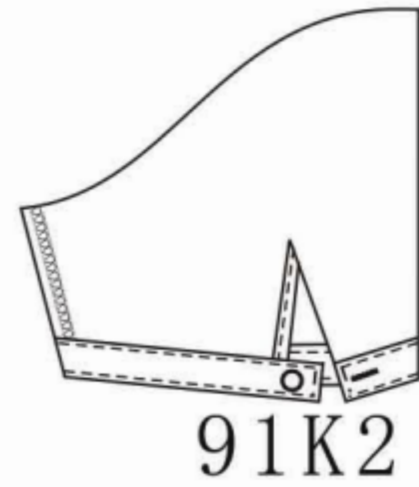

Short sleeve with 2.0cm cuff one button one buttonhole back vent 2.0cm

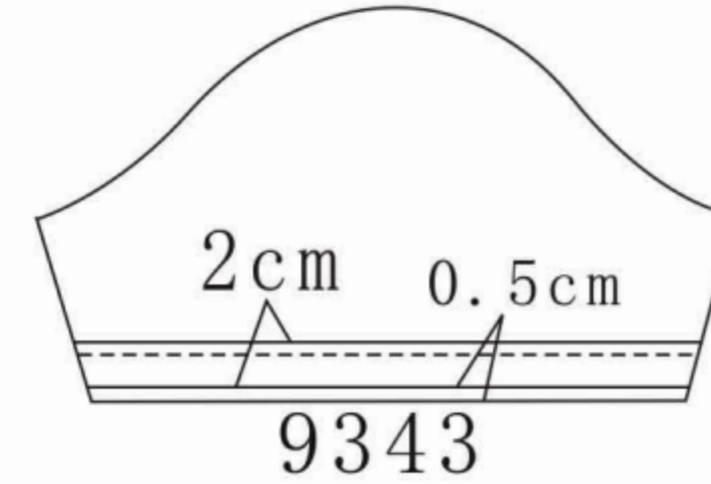

Short sleeve imitation hem with contrast piping—

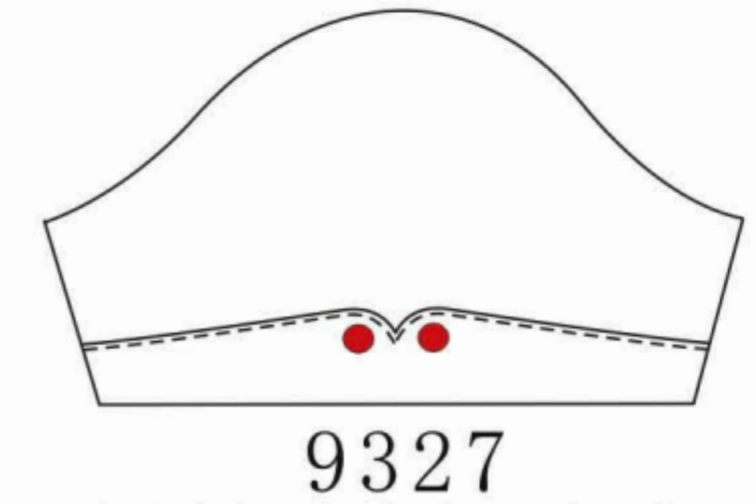

Short sleeve with 2 round houseshoe cuff with 2 buttons

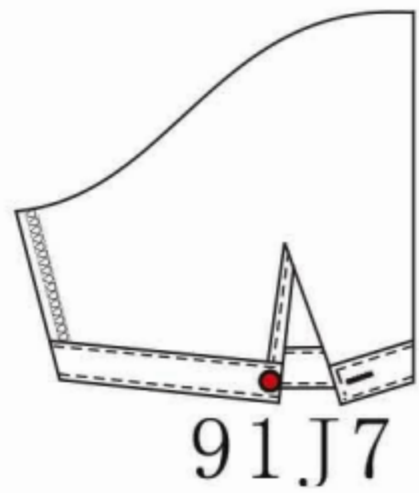

Short sleeve with 2.0cm cuff one button one buttonhole back vent 2.0cm, no small extender

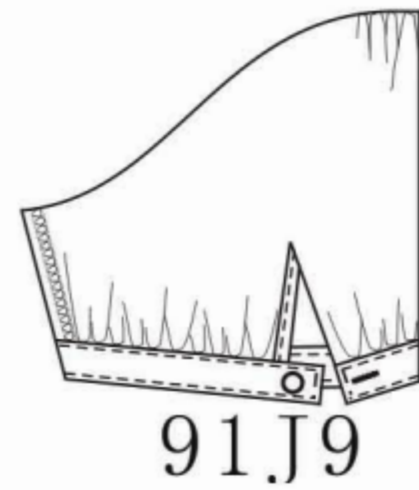

Short bubble sleeve with 2.0cm cuff one button one buttonhole back vent 2.0cm

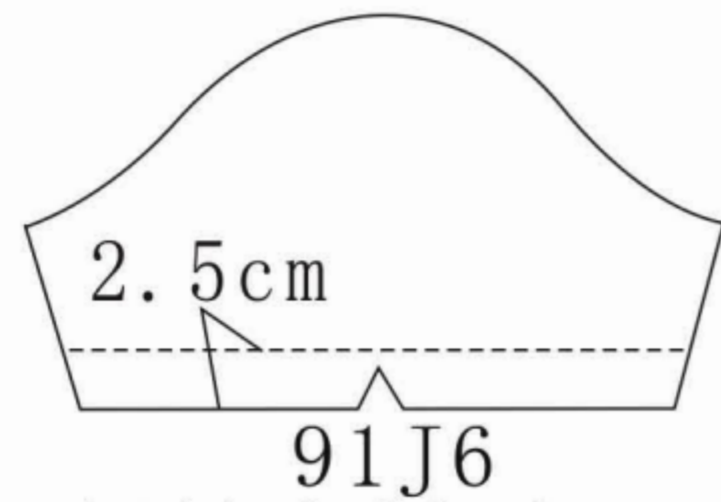

Short sleeve with plain hem 2.5cm triangle opening, no button

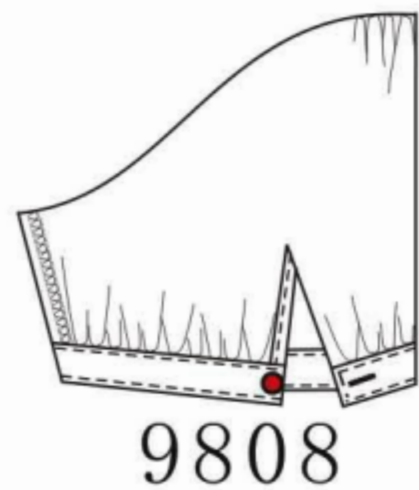

Short bubble sleeve with 2.0cm cuff one button one buttonhole back vent 2.0cm, no extender

Cuff pleat style

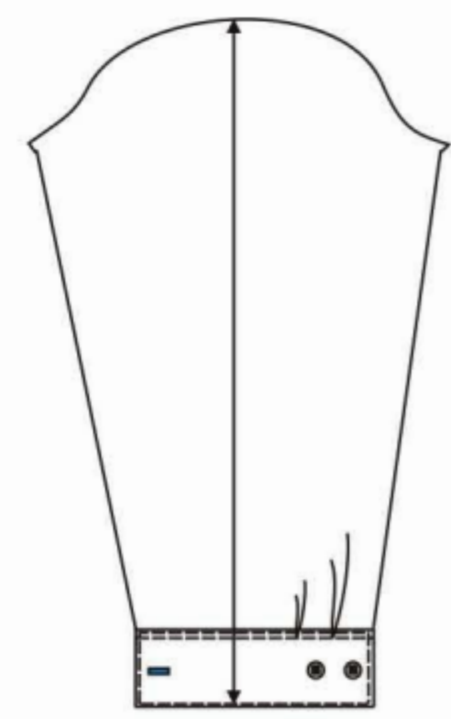

△ 91J3
Double pleats

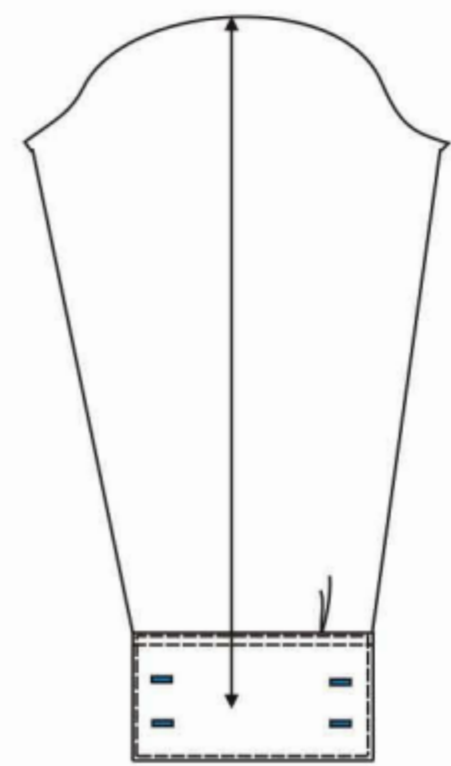

91J2
Single pleat

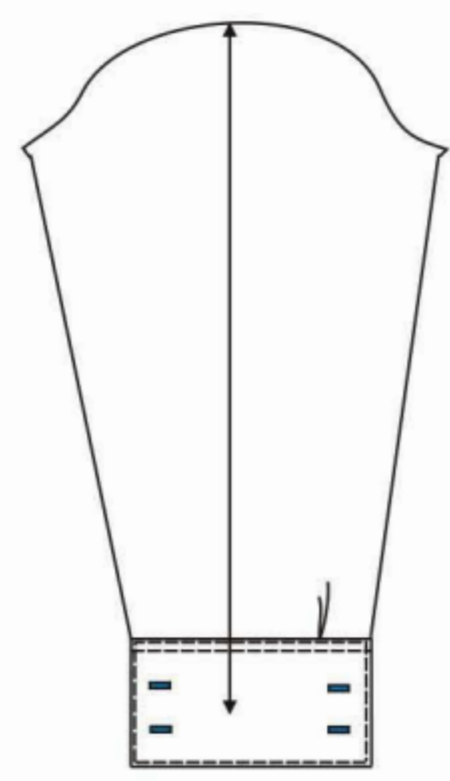

92B8
No pleat

Collar band style for closed collar

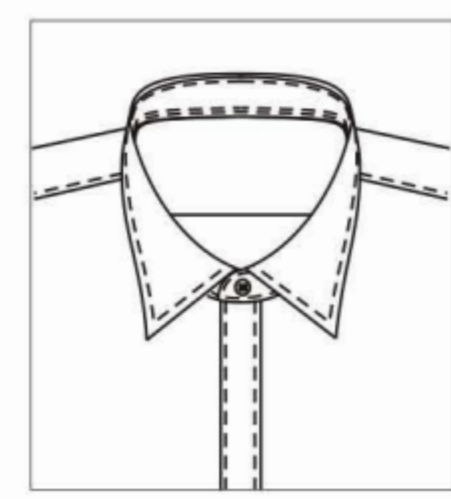

△ 9400
Round collar band
with one button

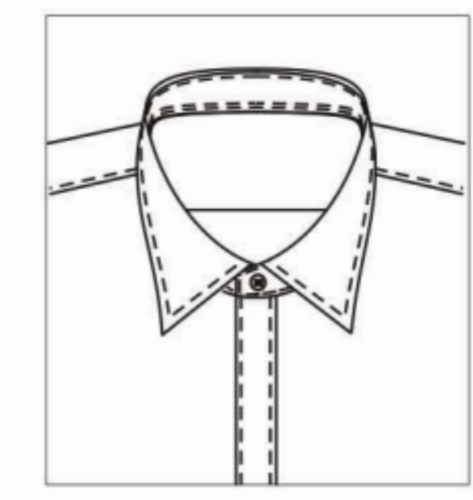

9401
Square collar band
with one button

Collar stay style

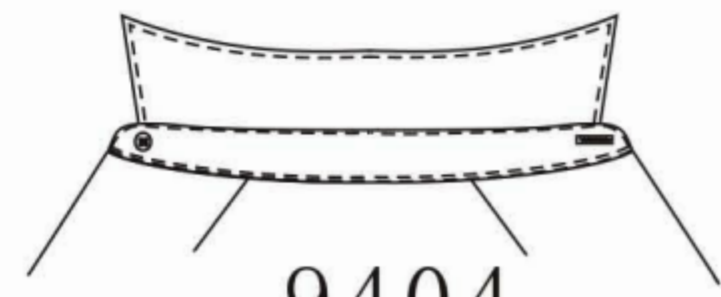

△ 9404
No collar stay

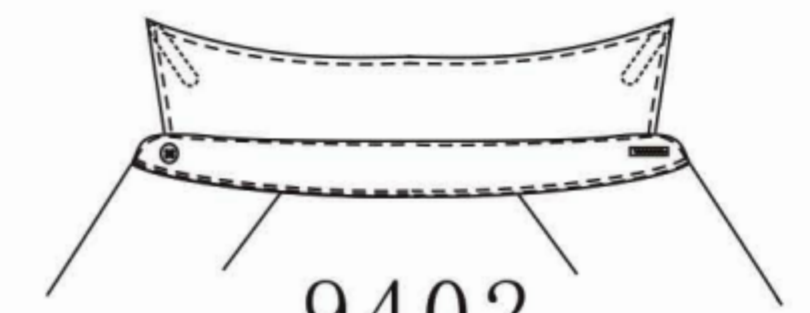

9402
Fixed collar stay

Pocket style

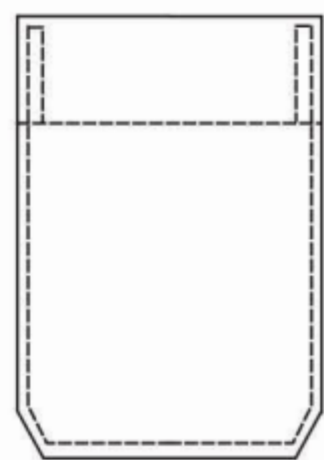

91H1

Hexagon pocket

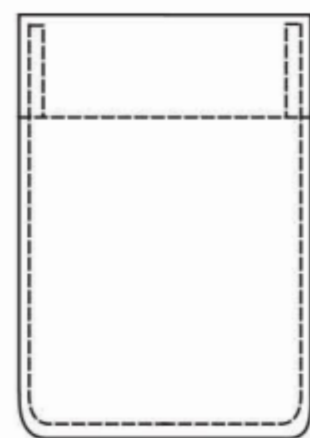

91G8

Round pocket

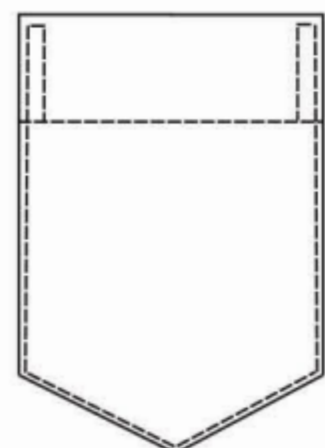

91G9

Triangle pocket

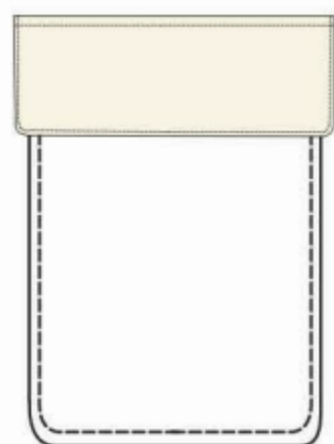

99M9

Round pocket with round flap

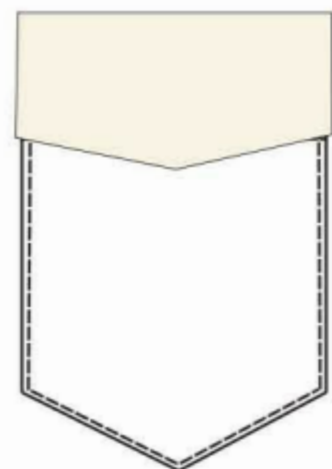

9827

Triangle pocket with triangle flap

Contrast position

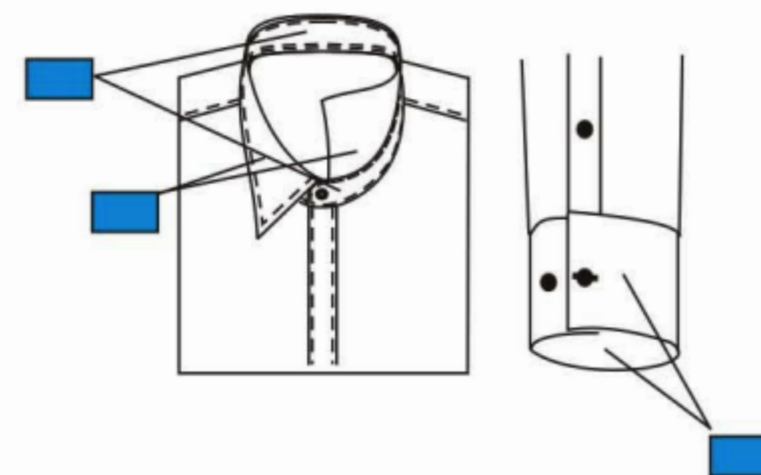

9610

Collar and cuff contrast fabric—

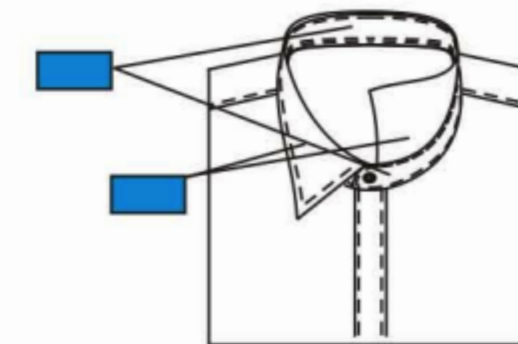

9611

Collar contrast fabric—

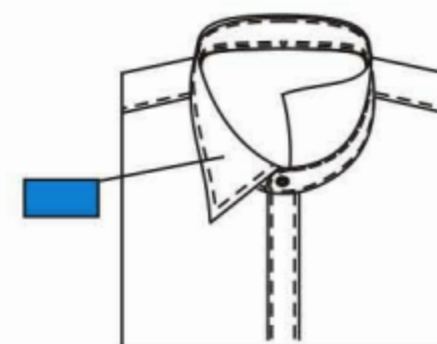

9239

The contrast fabric for top side of collar—

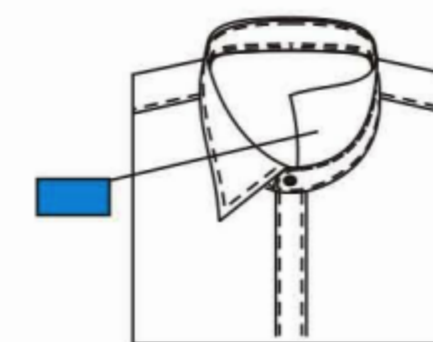

9613

The contrast fabric for inside collar—

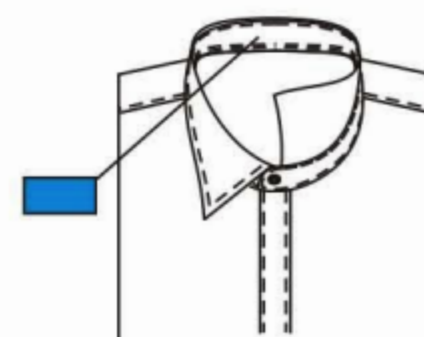

9614

The contrast fabric for inside collar band—

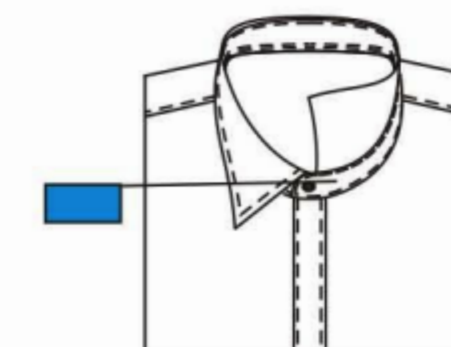

9240

The contrast fabric for exterior collar band—

Contrast position

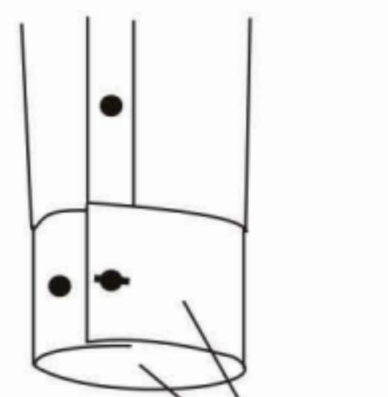

9612

The contrast fabric for cuff—

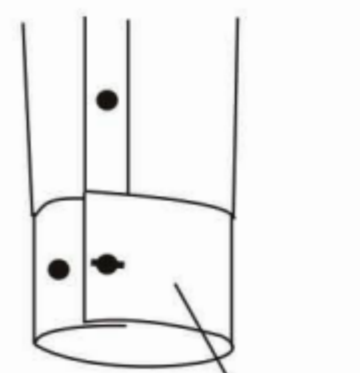

9241

The contrast fabric for top side of cuff—

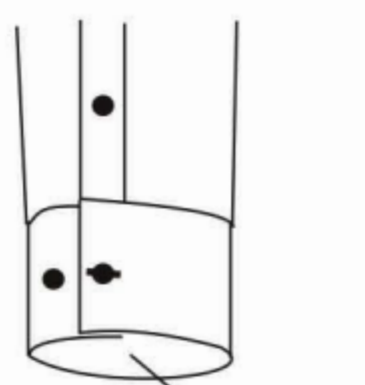

9615

The contrast fabric for inside of cuff—

Placket width

- 91A4 Placket width 2.0cm
- 91A5 Placket width 2.5cm
- 91A6 Placket width 3.0cm

Cuff height

- 91L2 Cuff height 2.0cm
- 91L3 Cuff height 3.0cm
- 9804 Cuff height 4.0cm
- 9649 Cuff height 5.0cm
- 91L4 Cuff height 6.0cm
- 91L5 Cuff height 6.5cm
- 9661 Cuff height 7.0cm
- 9662 Cuff height 8.5cm
- 91L7 Cuff height 7.0cm,4cm
- 92A6 Cuff height 5.0cm,6cm
- 91L6 Cuff height 11.0cm
- 9650 Cuff height 5.0cm, 7cm

Closed collar style

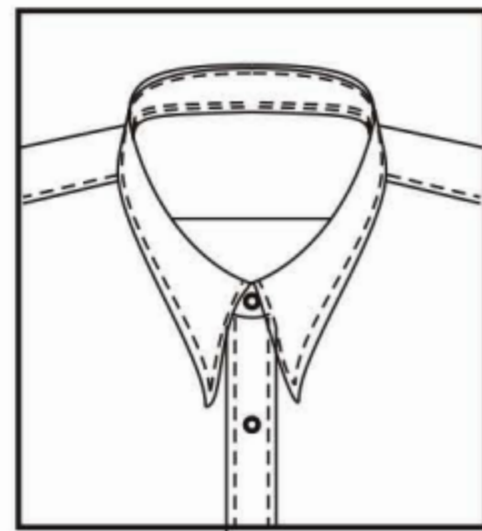

Pointed collar

- 9368 Small pointed collar, collar length 4.2cm
- 9307 Small pointed collar, collar length 4.8cm
- 91N9 Middle pointed collar, collar length 5.4cm
- 9B30 Middle pointed collar, collar length 6.6cm
- 9369 Big pointed collar, collar length 7.2cm
- △91A3 Big pointed collar, collar length 7.8cm

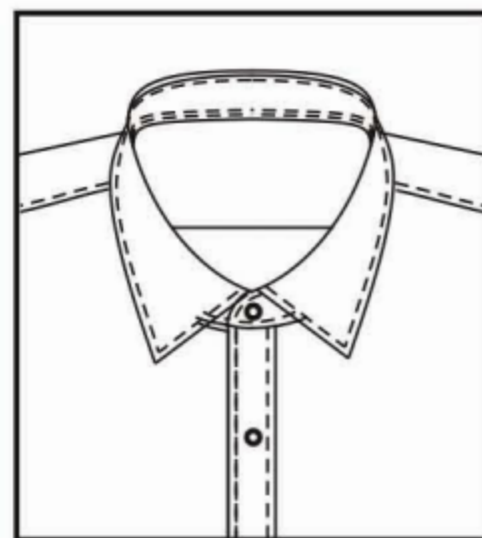

Square collar

- 9305 Small square collar, collar length 4.2cm
- 9370 Small square collar, collar length 4.8cm
- 9306 Middle square collar, collar length 5.4cm
- 9372 Middle square collar, collar length 6.0cm
- 9371 Middle square collar, collar length 6.6cm
- 9373 Big pointed collar, collar length 7.2cm
- 9303 Big pointed collar, collar length 7.8cm

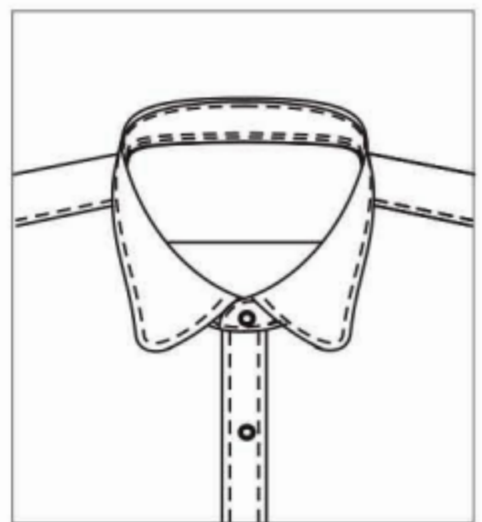

91M7

Small round collar

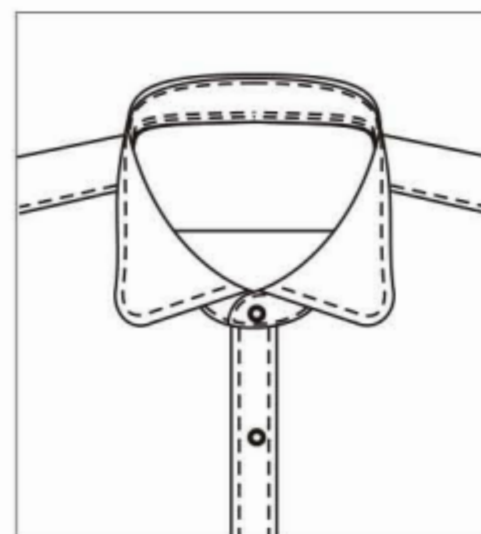

91M8

Middle round collar

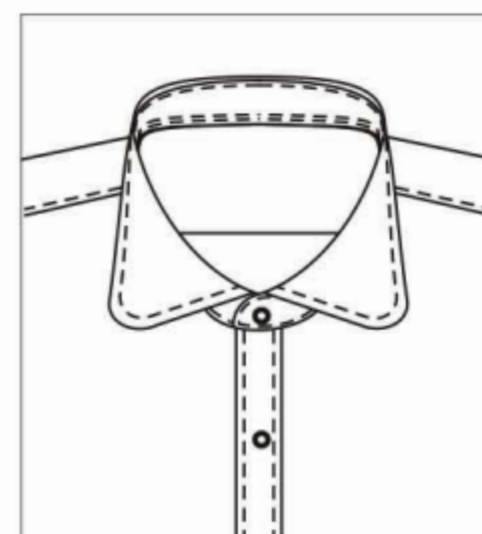

91M9

Big round collar

V shape collar style

20

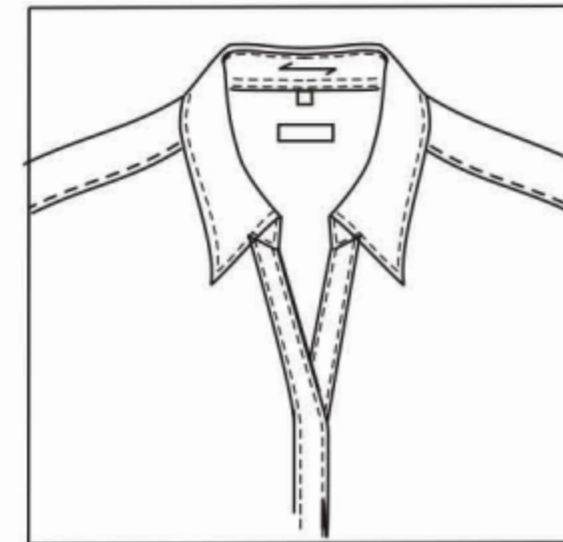

- 9415 V shape small pointed collar, collar length 4.2cm
- 9416 V shape small pointed collar, collar length 4.8cm
- 9417 V shape middle pointed collar, collar length 5.4cm
- 9418 V shape middle pointed collar, collar length 6.0cm
- 9420 V shape large pointed collar, collar length 7.2cm
- 92A2 V shape middle pointed collar, collar length 6.6cm
- 92A3 V shape large pointed collar, collar length 7.8cm

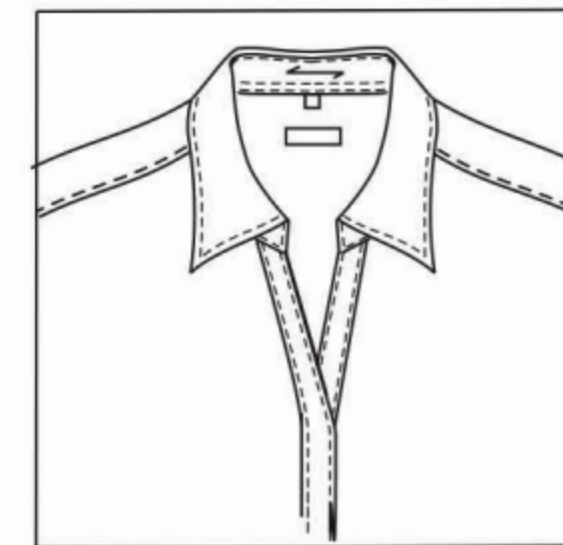

- 9409 V shape small square collar, collar length 4.2cm
- 9410 V shape small square collar, collar length 4.8cm
- 9411 V shape middle square collar, collar length 6.0cm
- 9412 V shape middle square collar, collar length 6.6cm
- 9413 V shape middle square collar, collar length 5.4cm
- 9414 V shape large square collar, collar length 7.8cm
- 9353 V shape large square collar, collar length 7.2cm

Mono position

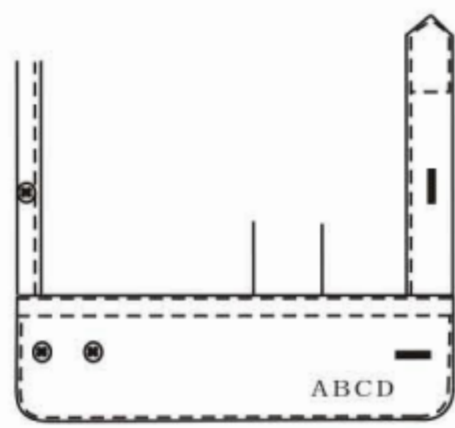

Right cuff

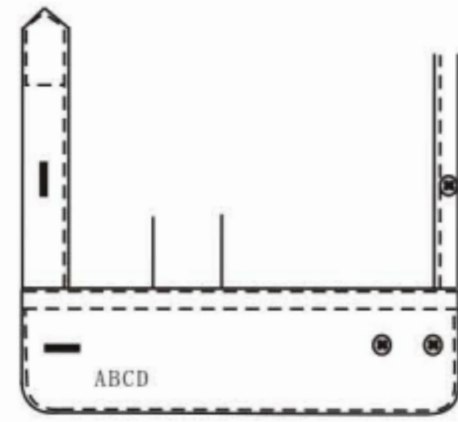

Left cuff

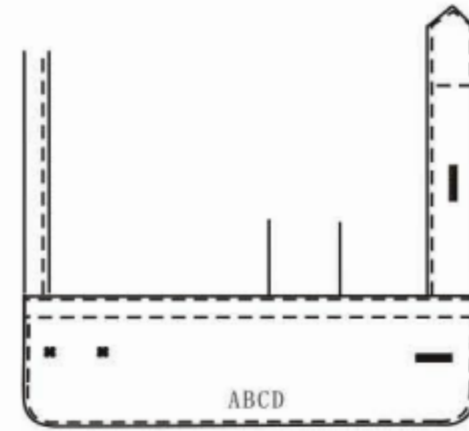

Middle of left cuff

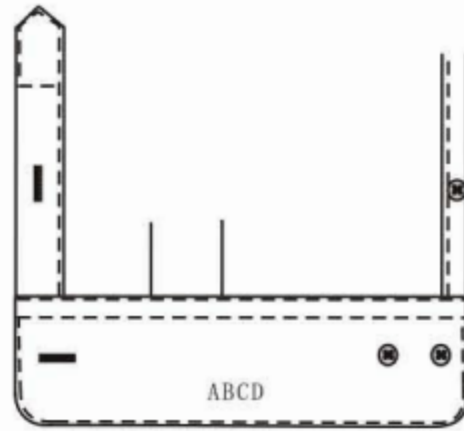

Middle of right cuff



Left/right big extender

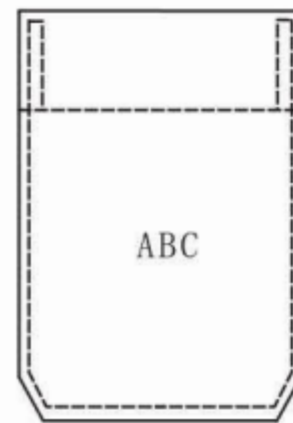

Middle of the pocket

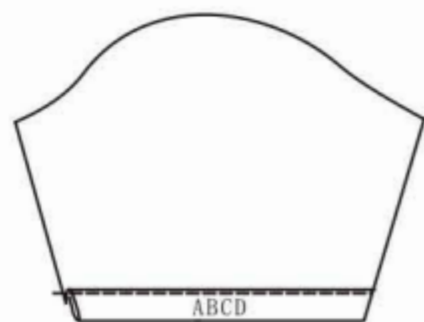

Right middle of the short sleeve hem

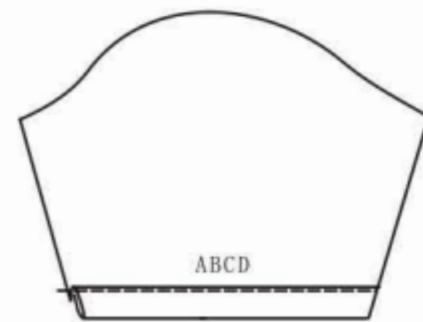

Right middle of the short sleeve
3cm above the hem

Left middle of the short sleeve hem

Mono position

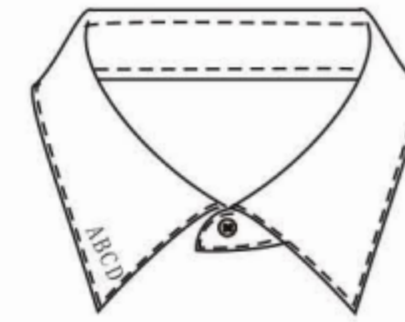

Left collar point

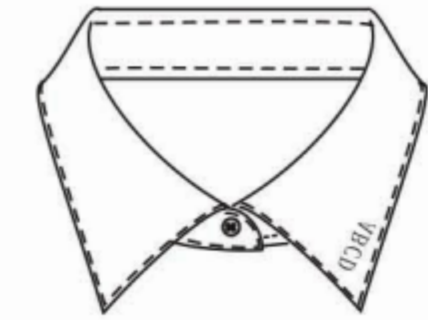

Right collar point

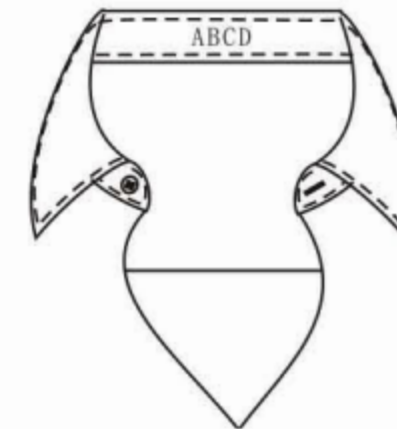

Middle of the inside collar band

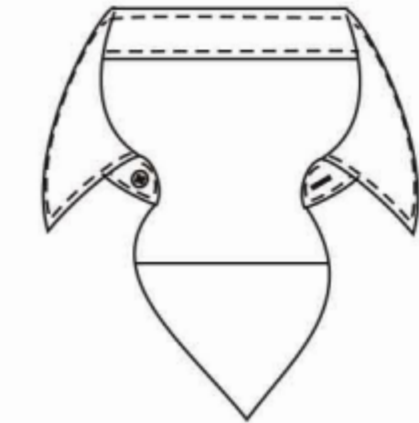

On the yoke

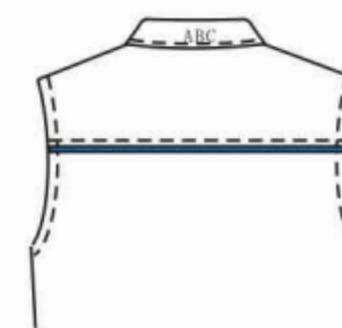

Middle of the outside
collar band

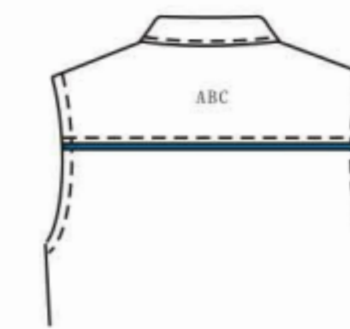

On the yoke

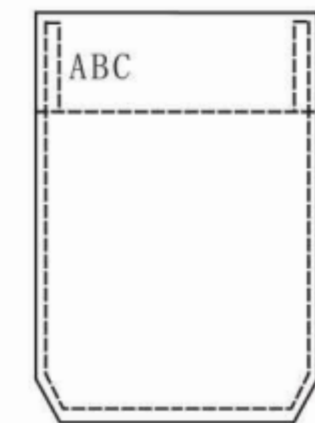

Right side of pocket hem

Mono position



5cm above the right placket bottom



Left chest

Mono position

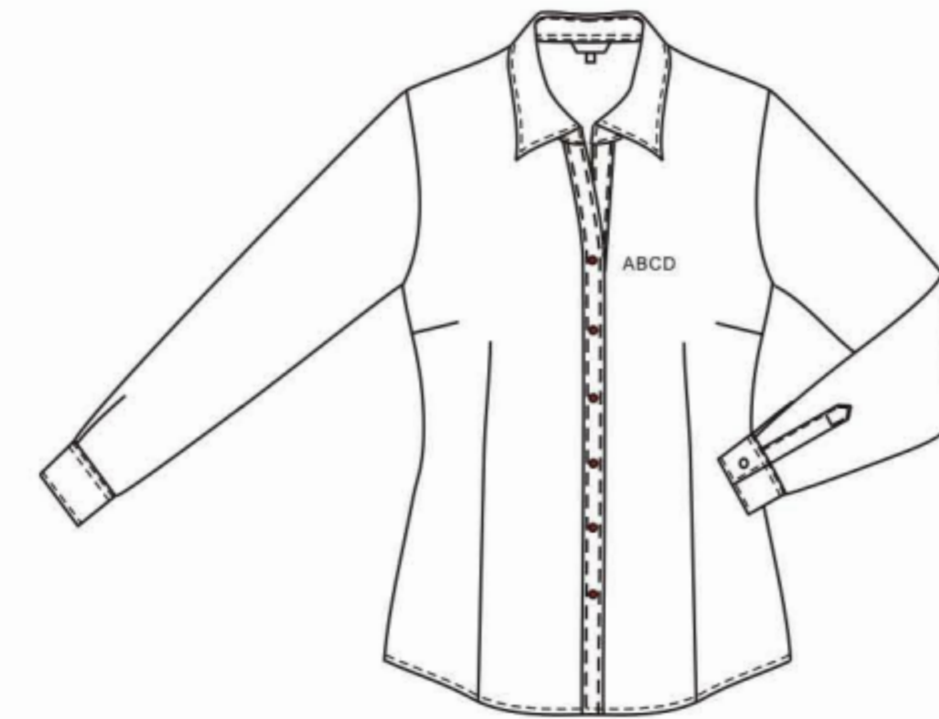

3cm above left pocket, 6cm to placket



3cm above right pocket, 6cm to placket

Mono position



2cm above right placket (Vertical)



on left panel, 2cm above bottom,
2cm to placket

Mono position

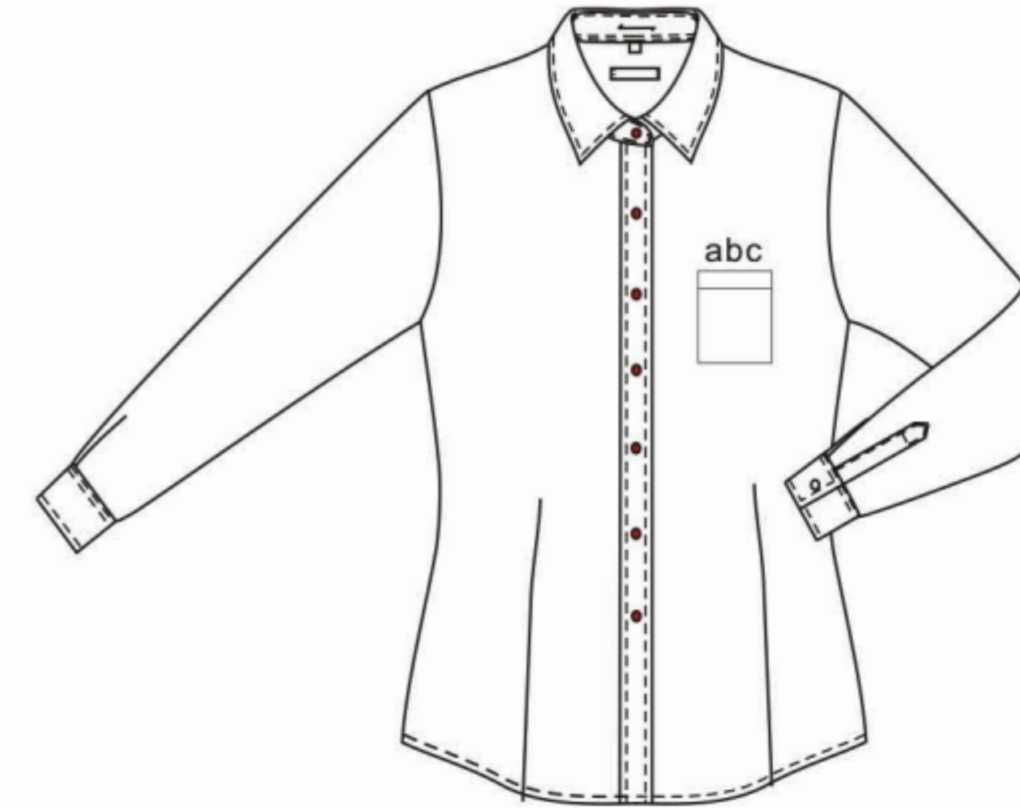

0.5cm above pocket opening

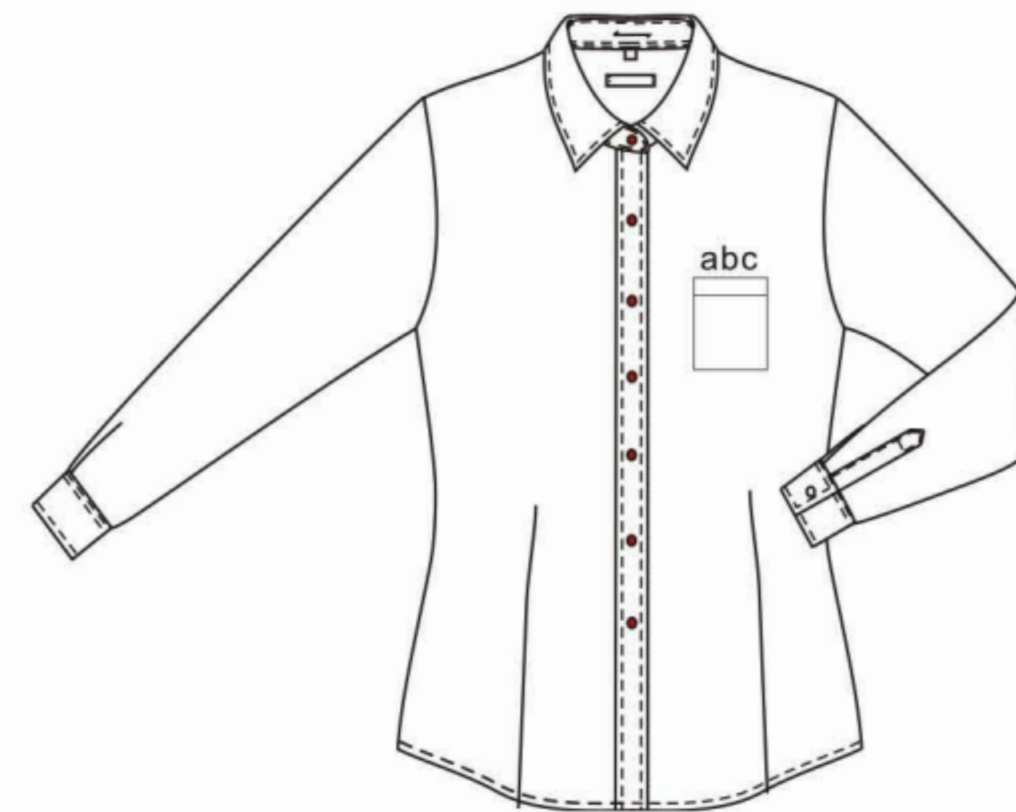

1.0cm above pocket opening

Mono position

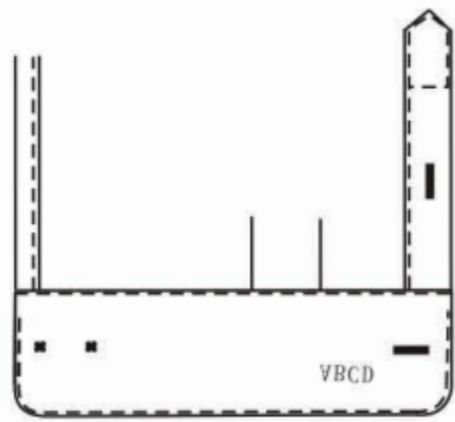

Inside of left cuff

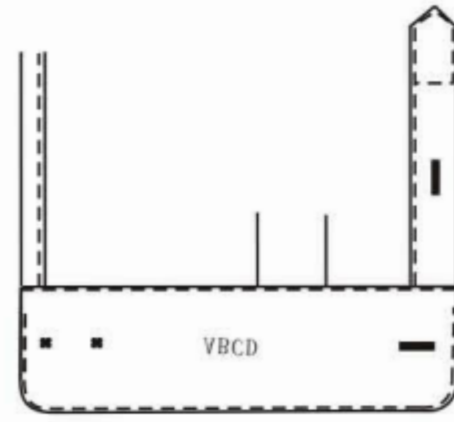

Middle of inside left cuff

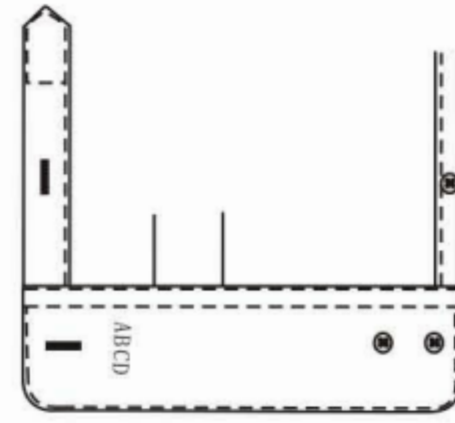

On side of right cuff
on side of left cuff



middle of left/right
big extender

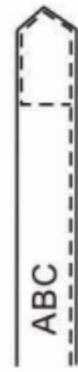

Collar/cuff pic stitch

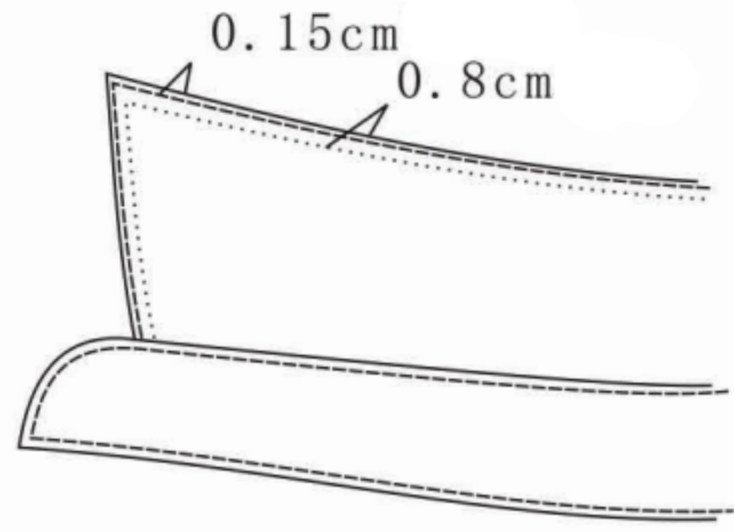

Collar pic stitch

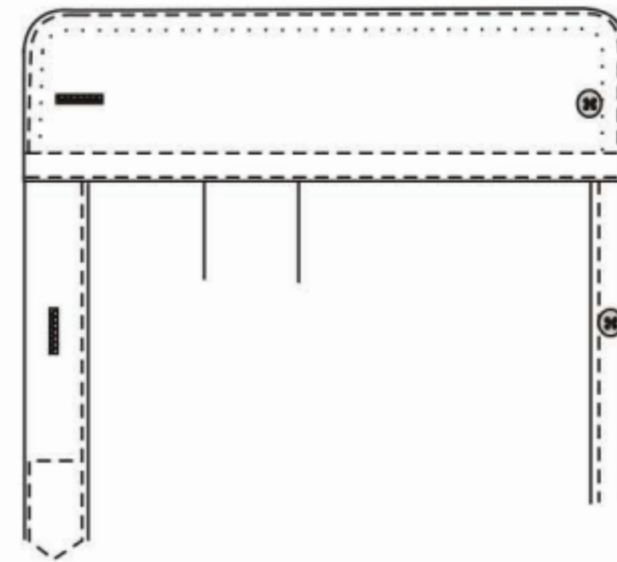

Cuff pic stitch

- 9602 Collar pic stitch - match stripe
- 9604 Collar pic stitch - customer appointed—
- 9603 Cuff pic stitch - match stripe
- 9605 Cuff pic stitch - customer appointed—
- 9600 Collar cuff pic stitch - match stripe
- 9601 Collar cuff pic stitch - customer appointed—

Buttonhole style



92H3

4 groups buttons
(2 buttons, 2 buttonholes)



9895

3 groups buttons
(3 buttons, 3 buttonholes)



91L8

2 buttons 2 buttonholes as group on placket