

jura®



GIGA X3c Instructions for Use



Original instructions for use
Before using the machine read the instructions for use.



Your GIGA X3c

Control elements	4
Important information	6
Proper use	6
For your safety	6
1 Preparing and using for the first time	10
JURA on the Internet	10
Operation with touchscreen display and Rotary Switch	10
Requirements for first-time use	11
Setting up the machine	11
Filling the bean container	11
Determining the water hardness	12
First-time use	12
Connecting milk	14
Settings by the service technician	14
Connect accessory (with wireless connection)	15
2 Preparation	16
Ways of preparing a beverage	16
Preparing speciality coffees	18
Preparing two speciality coffees	18
Preparing speciality coffees with milk	18
Caffè Barista and lungo Barista	19
Ground coffee	19
Hot water	21
3 Daily operation	22
Switching on the machine	22
Daily maintenance	22
Regular maintenance	23
Switching off the machine	23
4 Permanent settings in programming mode	24
Product settings	25
Setting the consistency of grind	27
Automatic switch-off	27
Time and date	28
Timer	29
Setting the water hardness	29
Unit for amount of water / time format	30
Energy-saving mode	31
Enabling and disabling functions	31
Language	32
Display brightness	33
Restore factory settings	33
Querying information	34



5	Maintenance	35
	Rinsing the machine	35
	Automatic milk system rinsing	35
	Cleaning the milk system	36
	Dismantling and rinsing the dual spout	36
	Changing the filter	38
	Cleaning the machine	39
	Descaling the machine	40
	Cleaning the bean container	42
6	Display messages	43
7	Troubleshooting	44
8	Transport and environmentally friendly disposal	46
	Transport / Emptying the system	46
	Disposal	46
9	Technical data	47
10	Index	48
11	JURA contact details / Legal information	52

Symbol description

Warnings

	WARNING	Always take note of any information marked with the words CAUTION or WARNING and a warning sign. The signal word WARNING draws your attention to potential serious injury, and the signal word CAUTION to potential minor injury.
	CAUTION	
CAUTION	CAUTION	CAUTION draws your attention to potential damage to the machine.

Symbols used

	Prompt to take action. This symbol means that you are being prompted to perform some action.
	Information and tips to make it even easier to use your GIGA.
	Display

Control elements

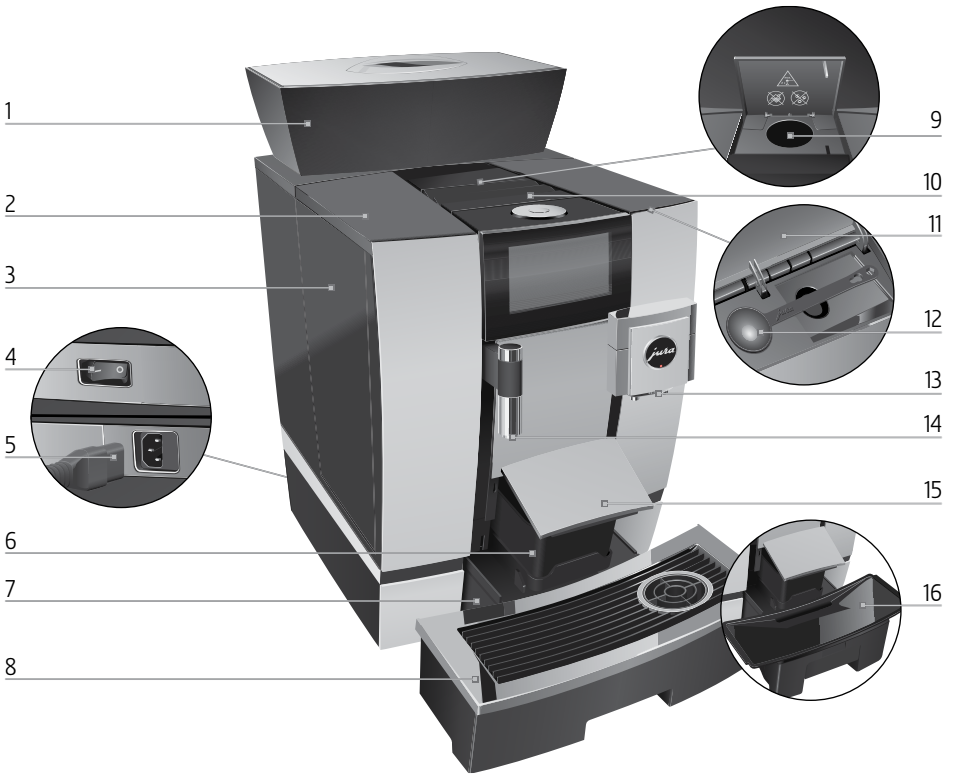

- | | | | |
|---|--|----|-----------------------------------|
| 1 | Bean container with aroma preservation cover | 9 | Filler funnel for ground coffee |
| 2 | Water tank cover | 10 | Ventilation slats (Venti Ports) |
| 3 | Water tank | 11 | Storage compartment cover |
| 4 | Power switch (back of the machine) | 12 | Measuring spoon for ground coffee |
| 5 | Plug-in mains cable (back of the machine) | 13 | Height-adjustable dual spout |
| 6 | Coffee grounds container | 14 | Height-adjustable hot-water spout |
| 7 | Drip tray | 15 | Drip tray cover (pivoting) |
| 8 | Cup grille | 16 | Insert for drip tray |



1 Rotary Switch

2 On/Off button  (under cover)

3 Touchscreen display

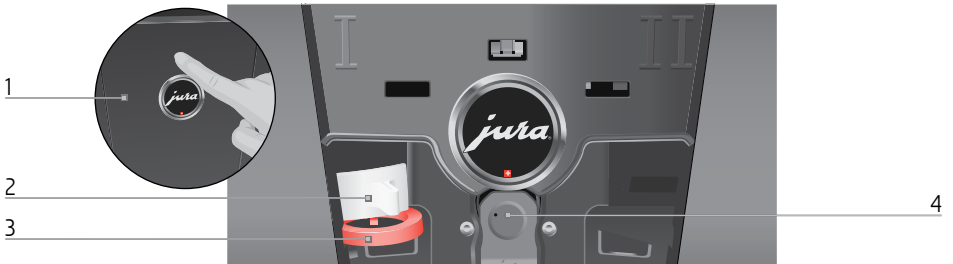

Back of the machine

1 Service cover (open by pressing with your finger)

2 Locking device

3 Sliding catch

4 Service socket with JURA Smart Connect

Accessories

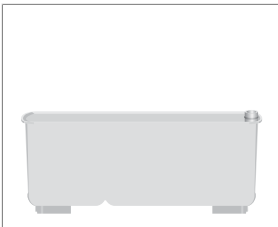

Container for milk system cleaning



Spanner with hexagonal hole (for milk system)

Important information

Proper use

This machine is intended for use by specialist or trained staff in businesses, light industry and agricultural facilities or for commercial use by non-professionals. It should only be used for coffee preparation and to heat milk and water. Use for any other purpose will be deemed improper. JURA Elektroapparate AG cannot accept any responsibility for the consequences of improper use.

Before using the machine read these instructions for use thoroughly and completely and comply with the instructions they contain. A warranty service is not applicable for damage or defects caused by non-compliance with the instructions for use. Keep these instructions for use close to the machine and pass them on to the next user.

The GIGA may only be operated by instructed persons. Non-professionals must be supervised during use.

For your safety

Please carefully read and observe the important safety information set out below.



To avoid danger of potentially fatal electric shock:

- Never use a machine which is damaged or has a defective mains cable.
- In the event of signs of damage, for example if there is a smell of burning, unplug the machine immediately from the power supply and contact JURA service.
- If the mains cable of this machine is damaged it must be replaced with a special mains cable, which is available directly from JURA or from authorised JURA service centres.



- Make sure that the GIGA and the mains cable are not located close to hot surfaces.
- Be careful to ensure that the mains cable is not trapped and does not rub against sharp edges.
- Never open and repair the machine yourself. Do not modify the machine in any way that is not described in these instructions for use. The machine contains live parts. If opened, there is a danger of potentially fatal injury. Repairs may only be carried out by authorised JURA service centres, using original spare parts and accessories.
- To completely and safely disconnect the machine from the power supply, first switch off the GIGA using the On/Off button  and then at the power switch. Only then should you remove the mains plug from the power socket.

There is a risk of scalds or burns on the spouts.

- Place the machine out of the reach of children.
- Do not touch any hot parts. Use the handles provided.
- Be careful to ensure that the dual spout is correctly installed and clean. If it is incorrectly fitted or becomes blocked, its parts might come off. There is a danger of parts being swallowed.

A defective machine is not safe and could cause injury or fire. To avoid damage and any associated risk of injury or fire:

- Never allow the mains cable to loosely hang down. The mains cable could pose a tripping hazard or become damaged.
- Protect the GIGA from environmental influences such as rain, frost and direct sunlight.

- Do not immerse the GIGA, mains cable or connections in water.
- Do not put the GIGA or any individual parts in the dishwasher. Only the insert for the drip tray, including the drip tray itself, and the coffee grounds container are dishwasher-safe.
- Before cleaning, switch the GIGA off with the On/Off button . Always wipe the GIGA with a damp cloth rather than a wet one, and protect it from prolonged exposure to water splash.
- The GIGA is not suitable for installation on a surface where a jet of water can be used.
- The machine must not be cleaned with a jet of water.
- Only connect the machine to the mains voltage in accordance with the information on the rating plate. The rating plate is located on the underside of your GIGA. Further technical data is provided in these instructions for use (see Chapter 9 'Technical data').
- Connect the GIGA directly to a domestic power socket. Using multi-socket adapters or extension cords may cause overheating.
- Do not use alkaline cleaning agents; only use a soft cloth and mild cleaning agents.
- Please only use original JURA maintenance products. Use of products that are not explicitly recommended by JURA could damage the machine.
- Do not use any coffee beans treated with additives or caramelised coffee beans.
- Only fill the water tank with fresh, cold water.
- Switch the machine off with the On/Off button  if you are going to be absent for a longer

period of time and remove the mains plug from the power socket.

- Children may not clean or service the machine unless supervised by a responsible person.
- Do not allow children to play with the machine.
- Keep children under the age of 8 away from the machine, or supervise them constantly.
- Children aged 8 and over may only operate the machine without supervision if they have been instructed in how to use it safely. Children must be able to recognise and understand the potential dangers arising from incorrect use.

People, including children, who

- do not have the physical, sensory or mental capabilities to use the machine safely or
- are inexperienced or lack knowledge in how to use the machine safely

must be supervised by a responsible person when using it, or must be instructed in how to use it correctly.

Safety measures when working with the external filter cartridge JURA:

- Filter cartridges should be kept out of the reach of children.
- Store filter cartridges in a dry place in the sealed packaging.
- Protect cartridges from heat and direct sunlight.
- Do not use damaged filter cartridges.
- Do not open filter cartridges.

1 Preparing and using for the first time

JURA on the Internet

Visit us on the Internet. You can download **short operating instructions** for your machine from the JURA website (www.jura.com). You will also find interesting and up-to-date information on your GIGA and on every aspect of coffee.

If you need assistance with using your machine, you can find this at www.jura.com/service.

Operation with touchscreen display and Rotary Switch

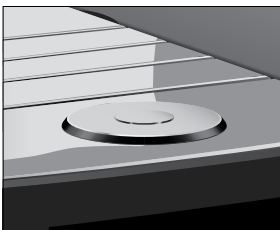
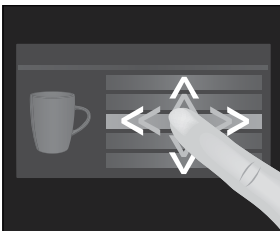
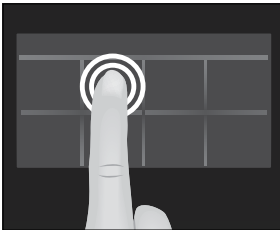

Your GIGA features an intuitive touchscreen display. There are two ways of operating the touch display:

- **Touch**

Touch the display with your finger, for example to start coffee preparation or undertake various settings in programming mode.

- **Slide**

Move your finger across the display from left to right or from top to bottom (or vice versa). For example, you can select one of the speciality coffees in the product selector view or switch between programme items in programming mode.

Programming with **Rotary Switch**: Also use the Rotary Switch. As soon as you turn it, the product selector view is displayed. Also navigate through the programme items in programming mode and change various settings.

Requirements for first-time use

A few preparations are necessary before the JURA service technician can set up your GIGA in your home. The following preparations must be carried out by a **professionally qualified person**:

- The mains connection for the GIGA must be protected by a residual current device (RCD).
 - There must be a power switch to disconnect the power supply to the GIGA.
 - The permanent water connection must have a shut-off valve with a non-return valve (type EA) and filter.
 - The permanent water connection must comply with the specified technical data (see Chapter 9 'Technical data').
 - The drain hose must be connected to a siphon.
- i** These preparations must be carried out by a qualified person.
i The preparations must be carried out before the JURA service technician sets up your GIGA in your home.

Setting up the machine

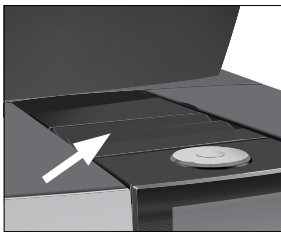

When setting up your GIGA, please note the following:

- Place the GIGA on a horizontal surface that is not sensitive to water (minimum height of 80 cm).
- Choose a spot for your GIGA which protects the machine against overheating. Ensure that the ventilation slats are not covered.

Filling the bean container

CAUTION

Coffee beans which have been treated with additives (e.g. sugar), ground coffee or freeze-dried coffee will damage the grinder.

- ▶ Only use roasted, untreated coffee beans to fill the bean container.
-
- ▶ Remove the aroma preservation cover.
 - ▶ Remove any dirt or foreign objects from inside the bean container.
 - ▶ Fill the bean container with coffee beans and close the aroma preservation cover.

1 Preparing and using for the first time

Determining the water hardness

When you use the machine for the first time, you must set the water hardness. If you do not know the hardness of your water, you can find this out first. Use the Aquadur® test strips supplied with the machine.

- ▶ Hold the test strip briefly (for 1 second) under flowing water. Shake off the water.
- ▶ Wait for about 1 minute.
- ▶ You will then be able to read the degree of water hardness from the discolouration of the Aquadur® test strip and the description on the packaging.

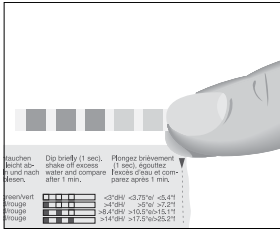

First-time use

- i** Before the machine is used for the first time, the permanent water connection must have been installed by a JURA service technician.

⚠ WARNING

If the machine is operated with a defective mains cable, there is a danger of potentially fatal electric shock.

- ▶ Never use a machine which is damaged or has a defective mains cable.

Precondition: The bean container has been filled.

- ▶ Connect the mains cable to the machine.
- ▶ Insert the mains plug into a power socket.
- ▶ Switch on the GIGA using the power switch on the back of the machine.

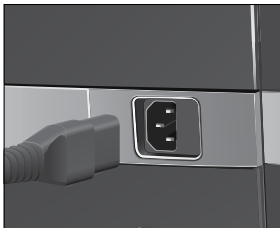

- ▶ Open the cover of the On/Off button.
- ▶ Press the On/Off button  to switch the GIGA on.
‘Sprachauswahl’ / ‘Deutsch’

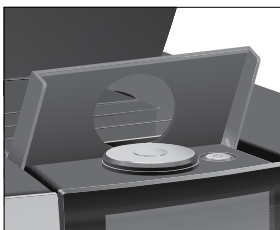

- i** To display more languages, move your finger either downwards or upwards in the selection list until the desired language comes into focus (e.g. **‘English’**).

- ▶ Touch 'Save'.
'Saved' appears briefly on the display to confirm the setting.
'Date'
- ▶ Enter the current date (format YYYY/MM/DD).
- ▶ Touch 'Save'.
'Saved'
'Units'
- ▶ Select the time format ('24 hrs.' or 'AM / PM').
- ▶ Touch 'Save'.
'Saved'
'Time'
- ▶ Enter the current time.
- ▶ Touch 'Save'.
'Saved'
'Filter operation'

i If you are operating the GIGA with an **external filter cartridge**, continue with this section. If you are using the GIGA without a filter, please go to the next section (see Chapter 1 'Preparing and using for the first time – First-time use without an external filter cartridge').

- ▶ Touch 'Save'.
'Saved'
'Filter capacity in litres:'
- ▶ Enter the filter capacity of the external filter cartridge.
- ▶ Touch 'Save'.
'Saved'
'System is filling'
'Machine is heating'
'Machine is rinsing', the system is rinsed. The rinse stops automatically. The start screen is displayed. Your GIGA is ready for use.

First-time use without an external filter cartridge

- ▶ Now move your finger across the controller and set it to '0'.
- ▶ Touch 'Save'.
'Descaling mode' / 'Saved'
'Water hardness'

- i** If you do not know the hardness of your water, you must find this out first (see Chapter 1 ‘Preparing and using for the first time – Determining the water hardness’).
 - ▶ Move your finger across the display to change the water hardness setting, e.g. to ‘25 °dH’.
 - ▶ Touch ‘Save’.
‘Saved’
‘System is filling’
‘Machine is heating’
‘Machine is rinsing’, the system is rinsed. The rinse stops automatically. The start screen is displayed. Your GIGA is ready for use.

Connecting milk

Your GIGA creates fine, creamy, feather-light milk foam with a perfect consistency. The most important requirement for frothing milk is a milk temperature of 4 – 8 °C. We would therefore recommend using a JURA milk cooler.

- ▶ Connect the milk pipe to the dual spout. To do this, attach the end of the milk pipe to the connector on the right-hand side of the dual spout.
- ▶ Connect the other end of the milk pipe to a milk cooler.

- i** Your GIGA is equipped with the **HP3** milk system.

Settings by the service technician

Your authorised JURA service technician can change various settings, e.g.:

- Codes: Four codes can be assigned. For each code, you can define which programme items are available or disabled. Each code corresponds to different authorisations. For instance, you can define that initiation of the maintenance programmes is disabled using a code.
- Activating/deactivating the ‘Silent Pump’ function (for preparing hot water)
- Choose not to display the red speedometer symbol for speed speciality coffees on the start screen.
- Activating/deactivating the external filter cartridge (depending on the option which was selected when the machine was first used)

You can also obtain the following optional accessories for your GIGA from your JURA service partner:

- Coffee grounds disposal / drip drain set
- Lockable bean container

Connect accessory (with wireless connection)

Your GIGA is equipped with the JURA Smart Connect. This allows you to connect the machine wirelessly to a compatible JURA accessory (e.g. the Cool Control milk cooler).

A frequency band of 2.4 GHz is used for this wireless connection. In this case, the maximum transmission power is below 1 mW.

- i** The Smart Connect can be protected against unauthorised access using a PIN. Activate the PIN function via J.O.E.[®] – your JURA app. You will find more information at www.jura.com/smartconnect.
- i** Please note that you can only connect either the accessory or J.O.E.[®] to the coffee machine via Smart Connect and not both at the same time.

Precondition: The start screen is displayed.

- ▶ Touch 'P'.
'Maintenance status'
- ▶ Move your finger across the display until 'Machine settings' is displayed in the centre.
- ▶ Touch 'Machine settings'.
'Switch off after'
- ▶ Move your finger across the display until 'Connect accessory' is displayed in the centre.
- ▶ Touch 'Connect accessory'.
'Connect accessory'
- ▶ Now follow the instructions on the display to connect the accessory to the GIGA.

2 Preparation

Basic information about preparing drinks:

- During the grinding operation you can change the coffee strength of **single products**. To do this, move your finger across the display or turn the Rotary Switch.
- During preparation you can change the preset **amounts** (e.g. amount of water or milk foam). To do this, move your finger across the display or turn the Rotary Switch.
- You can stop preparation at any time. To do this, press the 'Cancel' button or the Rotary Switch.

Coffee tastes best served hot. A cold porcelain cup cools the beverage – and impairs the taste. We therefore recommend prewarming the cups. The full coffee aroma can develop only in prewarmed cups. You can purchase a JURA cup warmer from your specialised dealer.

You can make **permanent settings** for all products in programming mode (see Chapter 4 'Permanent settings in programming mode – Adjusting the product settings').

Ways of preparing a beverage

The GIGA offers various ways of preparing a speciality coffee, milk or hot water.

Preparation using the start screen: Simply touch the desired product. The following products are displayed as standard on the start screen:

Page '1/2'	Page '2/2'
'Espresso'	'Jug of coffee'
'Coffee'	'Caffè latte'
'Caffè Barista'	'Macchiato'
'Lungo Barista'	'Flat White'
'Hot water'	'Hot water for green tea'
'Cappuccino'	'2 x Espresso'
'Latte macchiato'	'2 x Coffee'
'Portion milk'	'Portion milk foam'

Using the product selector view (Rotary Selection): Only some of the products you can prepare are shown on the start screen. As soon as you turn the Rotary Switch, more products are displayed in a **product selector view**.

Turn the Rotary Switch or move your finger across the display to bring the desired product into focus. Touch the product or press the Rotary Switch to start preparation. The following additional products are shown in the product selector view:

- 'Ristretto'
- 'Special'
- 'Espresso doppio'
- 'Hot water for black tea'
- '2 x Ristretto'
- '2 x Special'
- '2 x Caffè Barista'
- '2 x Lungo Barista'
- '2 x Cappuccino'
- '2 x Latte macchiato'
- '2 x Macchiato'
- '2 x Flat White'
- '2 x Caffè latte'
- '2 x Portion milk'
- '2 x Portion milk foam'

- i** The product selector view disappears automatically after 10 seconds if no preparation is started.
- i** The last product selected always appears first in the product selector view.
- i** You can move any of the standard products programmed in your GIGA to your preferred position on the start screen and make it one of your favourites. You can duplicate and personalise your favourite speciality coffees by giving them a new product name and individual settings (e.g. amount and coffee strength) (see Chapter 4 'Permanent settings in programming mode – Product settings'). Please note that the descriptions provided in the following sections always refer to the default settings.

Preparing speciality coffees

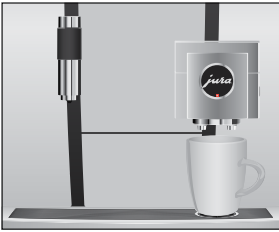

Example: Proceed as follows to prepare one coffee.

Precondition: The start screen is displayed.

- ▶ Place a cup under the dual spout.
- ▶ Touch **'Coffee'**.
Preparation starts. The preset amount of water for coffee flows into the cup.
Preparation stops automatically. Your GIGA is once more ready for use.

Preparing two speciality coffees

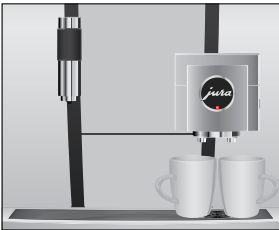

Example: Proceed as follows to prepare **two ristretti** (using product selector view).

Precondition: The start screen is displayed.

- ▶ Place two cups under the dual spout.
- ▶ Turn the Rotary Switch to view the **product selector**.
- ▶ Move your finger across the display until **'2 x Ristretto'** is displayed in the centre.
- ▶ Touch **'2 x Ristretto'** to start preparation.
Preparation starts. The preset amount of water for coffee flows into the cups. Preparation stops automatically. Your GIGA is once more ready for use.

Preparing speciality coffees with milk



Your GIGA prepares latte macchiato, cappuccino, flat white and other speciality coffees with milk at the touch of a button. There is no need to move the glass or cup.

Example: Proceed as follows to prepare one latte macchiato.

Precondition: The start screen is displayed. Milk is connected to the dual spout.

- ▶ Place a glass under the dual spout.
 - ▶ Touch **'Latte macchiato'**.
'Latte macchiato', the preset amounts of milk and milk foam flow into the glass.
- i** There is a short interval while the hot milk separates from the milk foam. This allows the typical layers of a latte macchiato to form.

Coffee preparation starts. The preset amount of water for espresso flows into the glass. Preparation stops automatically. Your GIGA is once more ready for use.

- i** 15 minutes after preparation, the milk system is automatically rinsed (see Chapter 5 ‘Maintenance – Automatic milk system rinsing’).

To ensure that the milk system in the dual spout always works properly, you must clean it **daily** (see Chapter 5 ‘Maintenance – Cleaning the milk system’).

Caffè Barista and lungo Barista

For the ‘caffè Barista’ and ‘lungo Barista’, the GIGA blends the coffee with hot water using a special preparation method. This results in a full-bodied speciality coffee which is particularly easy to digest. You can change the amount of this additional water (see Chapter 4 ‘Permanent settings in programming mode – Adjusting the product settings’).

Products with a bypass amount of water setting are marked with a **red speedometer symbol** in the start screen and in the product selector.

- i** Your authorised JURA service technician can set the machine so that the red speedometer symbol is not displayed next to these ‘speed speciality coffees’.
- i** For products with a set bypass amount of water, it is not possible to change the fill volume during the preparation process.

Ground coffee

You can choose to use another coffee variety, for example decaffeinated coffee, with the filter funnel for ground coffee.

Basic information about ground coffee:

- Never add more than two level measuring spoons of ground coffee.
- Use ground coffee which is not ground too finely. Very fine coffee can block up the system so that the coffee only comes out in drips.
- If you did not fill the machine with a sufficient amount of ground coffee, ‘**Not enough ground coffee**’ is displayed and the GIGA stops the operation.

2 Preparation

- The desired speciality coffee must be prepared within approximately one minute after filling with the ground coffee. Otherwise the GIGA stops the operation and is once more ready for use.
- All speciality coffees with ground coffee are always prepared following the same model.

Example: Proceed as follows to prepare one coffee using ground coffee.

Precondition: The start screen is displayed.

- ▶ Place a cup under the dual spout.
- ▶ Open the cover of the filler funnel for ground coffee.
'Please add ground coffee'
- ▶ Place one level measuring spoon of ground coffee into the filler funnel.
- ▶ Close the cover of the filler funnel.
- ▶ Touch **'Coffee'**.

The speciality coffees you can prepare with ground coffee are displayed.
Preparation starts. **'Coffee'** and the fill volume are displayed.
The preset amount of water for coffee flows into the cup.
Preparation stops automatically. Your GIGA is once more ready for use.

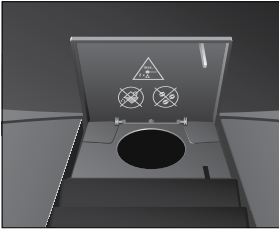

Hot water

The GIGA allows you to prepare different variants of hot water:

- 'Hot water'
- 'Hot water for green tea'
- 'Hot water for black tea'

⚠ CAUTION

There is a danger of scalding from hot water splashes.

- ▶ Avoid direct contact with the skin.

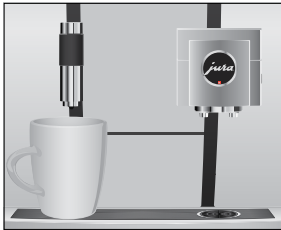

Example: Proceed as follows to prepare hot water for **black tea**.

Precondition: The start screen is displayed.

- ▶ Place a cup under the hot-water spout.
- ▶ Turn the Rotary Switch to view the product selector.
- ▶ Move your finger across the display until 'Hot water for black tea' is in focus.
- ▶ Touch 'Hot water for black tea'.

'Hot water for black tea', the preset amount of water flows into the cup.

Preparation stops automatically. Your GIGA is once more ready for use.

3 Daily operation

Switching on the

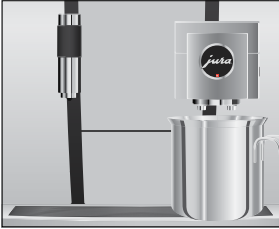

- ▶ Place a receptacle under the dual spout.

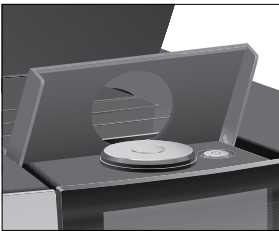

- ▶ Open the cover of the On/Off button.
- ▶ Press the On/Off button  to switch the GIGA on.
‘Welcome to JURA’
‘Machine is heating’
‘Machine is rinsing’, the system is rinsed. The rinse stops automatically. Your GIGA is ready for use.

Daily maintenance

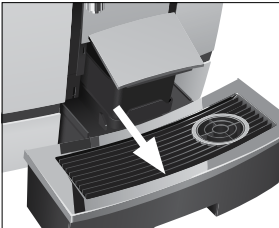

To ensure that you get many years of reliable service out of your GIGA and to guarantee the optimum coffee quality, the machine requires daily maintenance.

- ▶ Pull out the drip tray.
 - ▶ Empty the coffee grounds container and the drip tray. Rinse them both with warm water.
- i** Always empty the coffee grounds container when the machine is **switched on**. This is the only way of resetting the coffee grounds counter.
- i** The insert for the drip tray, including the drip tray itself, and the coffee grounds container are dishwasher-safe.
- ▶ Refit the coffee grounds container and the drip tray.
 - ▶ Clean the milk system in the dual spout (see Chapter 5 ‘Maintenance – Cleaning the milk system’).
 - ▶ Remove the milk pipe and rinse it thoroughly under running water.
 - ▶ Dismantle and rinse the dual spout (see Chapter 5 ‘Maintenance – Dismantling and rinsing the dual spout’).
 - ▶ Wipe the surface of the machine with a clean, soft, damp cloth (e.g. microfibre cloth).

- i** To clean the display, you can disable it under ‘Maintenance status’ / ‘Lock display’.

You will find more information about caring for your GIGA in programming mode under ‘Maintenance status’ / ‘Maintenance information’.

Regular maintenance

Carry out the following maintenance actions **regularly** or **as required**:

- In the interests of hygiene, we recommend changing the milk pipe and interchangeable milk spout on a regular basis (approximately every 3 months). Replacements are available from specialised dealers. Your GIGA is equipped with the **HP3** milk system.
- Traces of milk and coffee may stick to the top and bottom of the cup grille. If this happens, clean the cup grille.

Switching off the machine

When the GIGA is switched off, the system is automatically rinsed if a speciality coffee has been prepared.

- i** If milk has been prepared, you will also be prompted to clean the milk system. If this happens, follow the instructions on the display.

Precondition: The start screen is displayed.

- ▶ Place a receptacle under the dual spout.

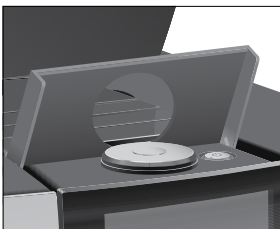
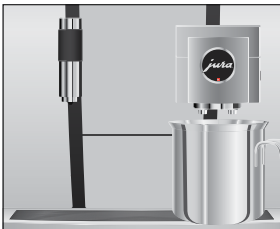

- ▶ Open the cover of the On/Off button.
 - ▶ Press the On/Off button .
- ‘Machine is rinsing’, the system rinses itself. The operation stops automatically. Your GIGA is switched off.

4 Permanent settings in programming mode

Touch 'P' to enter programming mode. Move your finger across the display or turn the Rotary Switch to navigate through the programme items and permanently save the desired settings. The following settings can be made:

Programme item	Sub-item	Explanation
'Maintenance status' (1/4)	'Clean', 'Change the filter' (only if filter is fitted), 'Descale', 'Clean the milk system', 'Rinse', 'Lock display', 'Maintenance information'	▶ Start the required maintenance programme here.
'Machine settings' (2/4)	'Switch off after'	▶ Set the time after which the GIGA should switch off automatically.
	'Time', 'Date'	▶ Set the time and date to use the timer function on your GIGA.
	'Timer'	▶ Specify a switch-on and switch-off time for each weekday.
	'Set consistency of grind'	▶ Adjust the consistency of grind to the coffee beans used.
	'Save energy'	▶ Activate energy-saving mode.
	'Lock/enable'	▶ Disable different machine functions.
	'Factory setting'	▶ Reset the machine to its factory setting.
	'Units'	▶ Select the unit for the amount of water and the time format.
	'Display'	▶ Change the display brightness.
	'Water hardness'	▶ You can set the water hardness of the water used.
'Choose language'		▶ Select your language.
	'Connect accessory', 'Disconnect accessories' (Only displayed if the JURA Smart Connect is being used.)	▶ Connect the GIGA wirelessly to a JURA accessory or disconnect the connection again.

Programme item	Sub-item	Explanation
	'Empty system'	▶ Empty the system to protect it from frost during transport.
	'Version'	Software version
'Product settings' (3/4)		▶ Select your settings for speciality coffees and hot water.
'Information' (4/4)	'Product counter', 'Day counter', 'Maintenance counter'	▶ Keep track of all products prepared and view the number of maintenance programmes performed.

Product settings

Touch a product for **approximately 2 seconds** to view the list of setting options:

- 'Product settings': Specify individual settings such as coffee strength, amount of water, etc.
- 'Product name': Change the name of the product.
- 'Delete': Delete the product from the start screen.
- 'Replace product': Replace the products on the start screen with your favourites.
- 'Copy product': Duplicate any product, for example to create a variant with a new product name and individual settings.
- 'Double product' (not for hot water): Create a double product of the desired speciality.

Adjusting the product settings

The following settings can be set permanently for all speciality coffees, milk and hot water:

Product	Coffee strength	Amount	More settings
Ristretto, espresso, coffee, special coffee, caffè Barista, lungo Barista	10 levels	Water: 15 ml – 290 ml Bypass water: 0 ml – 580 ml	Temperature (low, normal, high), product name, delete/replace/copy/double product
Espresso doppio	10 levels	Water: 15 ml – 290 ml (2 strokes) Bypass water: 0 ml – 580 ml	Temperature (low, normal, high), product name, delete/replace/copy product

4 Permanent settings in programming mode

Product	Coffee strength	Amount	More settings
Pot of coffee	10 levels	Water: 15 ml – 290 ml Bypass water: 0 ml – 580 ml	Number of strokes (1–5), temperature (low, normal, high), product name, delete/replace/copy product
Cappuccino	10 levels	Water: 15 ml – 290 ml Bypass water: 0 ml – 580 ml Milk foam: 0 sec. – 120 sec.	Milk temperature, temperature (low, normal, high), product name, delete/replace/copy/double product
Latte macchiato	10 levels	Water: 15 ml – 290 ml Bypass water: 0 ml – 580 ml Milk foam: 0 sec. – 120 sec. Milk: 0 sec. – 120 sec. Interval: 0 sec. – 60 sec.	Milk and milk foam temperature, temperature (low, normal, high), product name, delete/replace/copy/double product
Espresso macchiato, flat white, caffè latte	10 levels	Water: 15 ml – 290 ml Bypass water: 0 ml – 580 ml Milk foam: 0 sec. – 120 sec. Milk: 0 sec. – 120 sec.	Milk and milk foam temperature, temperature (low, normal, high), product name, delete/replace/copy/double product
Portion of milk foam, portion of milk	–	Milk foam: 0 sec. – 120 sec. Milk: 0 sec. – 120 sec.	Milk and milk foam temperature, product name, delete/replace/copy/double product
Hot water, hot water for green tea, hot water for black tea	–	Water: 25 ml – 450 ml	Temperature (low, normal, high), product name, delete/replace/copy product

Permanent settings in programming mode always follow the same model.

Example: Proceed as follows to change the coffee strength for one espresso.

Precondition: The start screen is displayed.

- ▶ Touch **'Espresso'** for **approximately 2 seconds** until the list of possible settings is displayed.
- ▶ Touch **'Product settings'**.
'Espresso'
- ▶ Move your finger across the display until **'Coffee strength'** is displayed in the centre.
- ▶ Now move your finger to the left or right to change the setting for the coffee strength.
- ▶ Touch **'Save'**.
'Saved' appears briefly on the display.
- ▶ Touch **'Back'** to return to the start screen.

Setting the consistency of grind

In the programme item **'Product settings'** / **'Set consistency of grind'** you can adjust the grinder to the degree of roast of your coffee.

The consistency of grind is correct if the coffee flows regularly from the dual spout. In addition a fine, thick crema forms.

Precondition: The start screen is displayed.

- ▶ Touch **'P'**.
'Maintenance status'
- ▶ Turn the Rotary Switch until **'Machine settings'** is displayed.
- ▶ Press the Rotary Switch.
'Switch off after'
- ▶ Turn the Rotary Switch until **'Set consistency of grind'** is displayed.
- ▶ Press the Rotary Switch.
- ▶ Turn the Rotary Switch to change the setting.
- ▶ Touch **'Save'**.
'Saved' appears briefly on the display.
'Set consistency of grind'
- ▶ Touch **'Back'** the number of times needed to display the start screen again.

Automatic switch-off

By instructing your GIGA to automatically switch itself off, you can cut down your energy consumption. If this function is activated, your GIGA switches off automatically after the preset time following the last action on the machine.

4 Permanent settings in programming mode

You can set the automatic switch-off to 15 minutes, 30 minutes, 1–15 hours, or inactive.

Precondition: The start screen is displayed.

- ▶ Touch 'P'.
'Maintenance status'
- ▶ Turn the Rotary Switch until 'Machine settings' is displayed.
- ▶ Press the Rotary Switch.
'Switch off after'
- ▶ Now move your finger to the left or right to change the switch-off time.
- ▶ Touch 'Save'.
'Saved' appears briefly on the display.
'Switch off after'
- ▶ Touch 'Back' the number of times needed to display the start screen again.

Time and date

You already set the time and date during first-time use. You can change this setting in programming mode:

- 'Machine settings' / 'Time'
- 'Machine settings' / 'Date'

i For the time format, you can choose between '24 hrs' and 'AM / PM' (see Chapter 4 'Permanent settings in programming mode – Unit for amount of water / time format').

Example: Proceed as follows to change the time.

Precondition: The start screen is displayed.

- ▶ Touch 'P'.
'Maintenance status'
- ▶ Turn the Rotary Switch until 'Machine settings' is displayed.
- ▶ Press the Rotary Switch.
'Switch off after'
- ▶ Turn the Rotary Switch until 'Time' is displayed.
- ▶ Press the Rotary Switch.
'Time'
- ▶ Enter the current time.
- ▶ Touch 'Save'.
'Saved' appears briefly on the display.
'Time'

- ▶ Touch 'Back' the number of times needed to display the start screen again.

Timer

In the programme item 'Machine settings' / 'Timer' you can set a switch-on and switch-off time for every weekday.

- i** For the time format, you can choose between '24 hrs' and 'AM / PM' (see Chapter 4 'Permanent settings in programming mode – Unit for amount of water / time format').

Example: Proceed as follows to set the GIGA to switch on on **Monday** at a time defined by you.

Precondition: The start screen is displayed.

- ▶ Touch 'P'.
'Maintenance status'
- ▶ Turn the Rotary Switch until 'Machine settings' is displayed.
- ▶ Press the Rotary Switch.
'Switch off after'
- ▶ Turn the Rotary Switch until 'Timer' is displayed.
- ▶ Press the Rotary Switch.
'Timer'
- ▶ Touch 'Monday'.
'Switch machine on'
- ▶ Enter the desired switch-on time.
- ▶ Touch 'Save'.
'Switch machine off'
- ▶ Touch 'Back' the number of times needed to display the start screen again.

Setting the water hardness

The harder the water is, the more frequently the GIGA needs to be descaled. It is therefore important to set the water hardness accurately.

The water hardness was set when the machine was first used. You can change this setting at any time.

The water hardness can be adjusted on a continuous scale between 1 °dH and 30 °dH.

Precondition: The start screen is displayed.

- ▶ Touch 'P'.
'Maintenance status'
- ▶ Turn the Rotary Switch until 'Machine settings' is displayed.
- ▶ Press the Rotary Switch.
'Switch off after'
- ▶ Turn the Rotary Switch until 'Water hardness' is displayed.
- ▶ Press the Rotary Switch.
'Water hardness'
- ▶ Now move your finger to the left or right to change the setting.
- ▶ Touch 'Save'.
'Saved' appears briefly on the display.
'Water hardness'
- ▶ Touch 'Back' the number of times needed to display the start screen again.

Unit for amount of water / time format

You can change the unit for the amount of water as well as the time format in programming mode ('Machine settings' / 'Units):

- 'Change units' ('ml' / 'oz')
- 'Set time format' ('24 hrs.' / 'AM / PM')

Example: Proceed as follows to change the unit for the amount of water from 'ml' to 'oz'.

Precondition: The start screen is displayed.

- ▶ Touch 'P'.
'Maintenance status'
- ▶ Turn the Rotary Switch until 'Machine settings' is displayed.
- ▶ Press the Rotary Switch.
'Switch off after'
- ▶ Turn the Rotary Switch until 'Change units' is displayed.
- ▶ Press the Rotary Switch.
'Change units'
- ▶ Now move your finger to the left or right to change the setting to 'oz'.
- ▶ Touch 'Save'.
'Saved' appears briefly on the display.
'Units'

- ▶ Touch 'Back' the number of times needed to display the start screen again.

Energy-saving mode

In the programme item 'Machine settings' / 'Save energy' you can set an energy-saving mode:

- '1'
 - Soon after the last preparation, the GIGA stops heating up. After approximately 5 minutes, the 'ESM' symbol (Energy Save Mode, E.S.M.®) is displayed.
 - Before you can prepare a speciality coffee, speciality coffee with milk, or hot water, the machine must heat up.
- '0'
 - All speciality coffees, speciality coffees with milk and hot water can be prepared without having to wait.

Example: Proceed as follows to switch energy-saving mode on.

Precondition: The start screen is displayed.

- ▶ Touch 'P'.
 - 'Maintenance status'
- ▶ Turn the Rotary Switch until 'Machine settings' is displayed.
- ▶ Press the Rotary Switch.
 - 'Switch off after'
- ▶ Turn the Rotary Switch until 'Save energy' is displayed.
- ▶ Press the Rotary Switch.
 - 'Save energy'
- ▶ Now move your finger across the controller and set it to '1'.
- ▶ Touch 'Save'.
 - 'Saved' appears briefly on the display.
 - 'Save energy'
- ▶ Touch 'Back' the number of times needed to display the start screen again.

Enabling and disabling functions

In the programme item 'Machine settings' / 'Lock/enable' you can disable/enable the following settings:

- 'One-off settings': One-off settings can be made **during preparation** (e.g. coffee strength or amount of water).
- 'Expert mode': You can access the product settings by touching a product for approximately 2 seconds.

4 Permanent settings in programming mode

- **'Rotary Selection': Product selector view** with additional products can be started by turning the Rotary Switch.
- **'Alarm displays':** The start screen displays messages such as 'Clean machine' or 'Clean the milk system'.

Example: Proceed as follows to prevent **one-off settings** being made during preparation.

Precondition: The start screen is displayed.

- ▶ Touch 'P'.
'Maintenance status'
- ▶ Turn the Rotary Switch until 'Machine settings' is displayed.
- ▶ Press the Rotary Switch.
'Switch off after'
- ▶ Turn the Rotary Switch until 'Lock/enable' is displayed.
- ▶ Press the Rotary Switch.
'Lock/enable'
- ▶ Touch 'One-off settings'.
'One-off settings'
- ▶ Now move your finger across the controller to close the lock symbol.
- ▶ Touch 'Save'.
'Saved' appears briefly on the display.
'Lock/enable'
- ▶ Touch 'Back' the number of times needed to display the start screen again.

Language

In this programme item you can set the language used by your GIGA.

Example: Proceed as follows to change the language from 'English' to 'Deutsch'.

Precondition: The start screen is displayed.

- ▶ Touch 'P'.
'Maintenance status'
- ▶ Turn the Rotary Switch until 'Machine settings' is displayed.
- ▶ Press the Rotary Switch.
'Machine settings'
- ▶ Press the Rotary Switch.
'Switch off after'

- ▶ Turn the Rotary Switch until 'Choose language' is displayed.
- ▶ Press the Rotary Switch.
'Choose language'
- ▶ Move your finger across the display until the desired language, e.g. 'Deutsch', is displayed in the centre.
- ▶ Touch 'Speichern'.
'Gespeichert' appears briefly on the display.
'Sprachauswahl'
- ▶ Touch 'Zurück' the number of times needed to display the start screen again.

Display brightness

In the programme item 'Machine settings' / 'Display' you can set the display brightness (as a percentage).

Precondition: The start screen is displayed.

- ▶ Touch 'P'.
'Maintenance status'
- ▶ Turn the Rotary Switch until 'Machine settings' is displayed.
- ▶ Press the Rotary Switch.
'Switch off after'
- ▶ Turn the Rotary Switch until 'Display' is displayed.
- ▶ Press the Rotary Switch.
'Display'
- ▶ Now move your finger to the left or right to change the setting.
- ▶ Touch 'Save'.
'Saved' appears briefly on the display.
'Display'
- ▶ Touch 'Back' the number of times needed to display the start screen again.

Restore factory settings

In the programme item 'Machine settings' / 'Factory setting' the machine can be reset to its factory setting: **All user settings** (apart from the 'water hardness') are reset to factory settings. Your GIGA then switches off.

Precondition: The start screen is displayed.

- ▶ Touch 'P'.
'Maintenance status'

- ▶ Turn the Rotary Switch until 'Machine settings' is displayed.
- ▶ Press the Rotary Switch.
'Switch off after'
- ▶ Turn the Rotary Switch until 'Factory setting' is displayed in the centre.
- ▶ Press the Rotary Switch.
'Factory setting' / 'Reset the machine to the factory settings?'
- ▶ Touch 'Yes'.
'Saved' appears briefly on the display.
Your GIGA is switched off.

Querying information

In the programme item 'Information' you can view the following information:

- 'Product counter': Number of prepared speciality coffees and hot water
- 'Day counter': Number of prepared speciality coffees and hot water. This counter can be reset to zero.
- 'Maintenance counter': Number of maintenance programmes performed (cleaning, descaling etc.)

Example: Proceed as follows to view the number of speciality coffees prepared.

Precondition: The start screen is displayed.

- ▶ Touch 'P'.
'Maintenance status'
- ▶ Turn the Rotary Switch until 'Information' is displayed.
- ▶ Press the Rotary Switch.
'Product counter'
- ▶ Press the Rotary Switch again.
- ▶ Touch '1/2' or turn the Rotary Switch to view the number of other products.
- ▶ Touch 'Back' the number of times needed to display the start screen again.

5 Maintenance

Your GIGA has the following integrated maintenance programmes:

- Rinsing the machine ('Rinse')
- Rinsing the milk system in the dual spout
- Cleaning the milk system in the dual spout ('Clean the milk system')
- Changing the filter ('Change the filter') (only if filter is activated)
- Cleaning the machine ('Clean')
- Descaling the machine ('Descale')

i Carry out each maintenance programme when you are prompted to do so.

i In the interests of hygiene, you should clean the milk system **daily** when you have been preparing milk.

Rinsing the machine

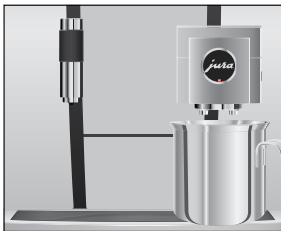

You can initiate the rinse operation manually at any time.

Precondition: The start screen is displayed.

- ▶ Place a receptacle under the dual spout.
- ▶ Touch 'P'.
- ▶ Touch 'Maintenance status'.
- ▶ Touch 'Maintenance status'.
- ▶ Touch 'Clean'.
- ▶ Move your finger across the display until 'Rinse' is displayed in the centre.
- ▶ Touch 'Rinse' to start the rinse operation.
- ▶ 'Machine is rinsing', 'Milk system is being rinsed', water flows out of the dual spout.
- ▶ The rinse stops automatically. Your GIGA is once more ready for use.

Automatic milk system rinsing

15 minutes after milk preparation, the milk system is **automatically** rinsed.

Cleaning the milk system

To ensure that the milk system in the dual spout always works properly, you must clean it **daily** when you have been preparing milk.

CAUTION

If the wrong cleaning agent is used, the machine could be damaged and/or traces could be left behind in the water.

- ▶ Use only original JURA maintenance products.

- i** JURA milk system cleaner is available from specialised dealers.
- i** To clean the milk system, use the container supplied.

Precondition: The start screen is displayed. 'Clean the milk system' is displayed.

- ▶ Touch 'Clean the milk system'.
- ▶ Touch 'Start'.
- ▶ Touch 'Start' again.
'Milk system cleaner' / 'Connect the milk tube'
- ▶ Remove the milk pipe from the milk container.
- ▶ Add a capful of milk system cleaner to the **rear** part of the container.

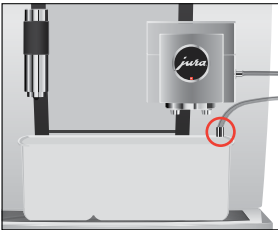
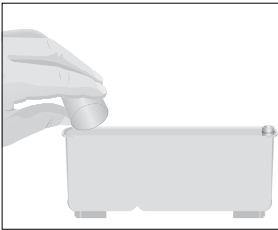

- ▶ Place the container under the dual spout and connect the milk pipe with the container.

- i** To connect the milk pipe to the container correctly, the pipe must be fitted with a connector.

- ▶ Touch 'Next'.
'Milk system is being cleaned', the dual spout and the milk pipe are cleaned.

The operation stops automatically. Your GIGA is once more ready for use.

Dismantling and rinsing the dual spout

The dual spout must be dismantled and rinsed **daily** if milk has been prepared to make sure it functions perfectly and also in the interests of hygiene.

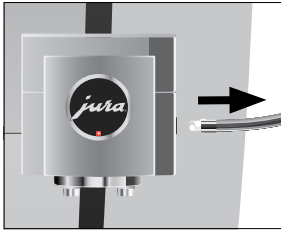

- ▶ Remove the milk pipe and rinse it thoroughly under running water.



- ▶ Pull the cover of the dual spout forwards and off.

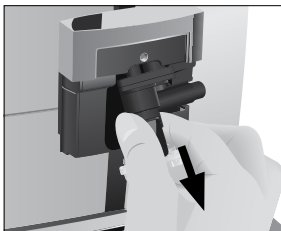

- ▶ Remove the milk system from the dual spout.

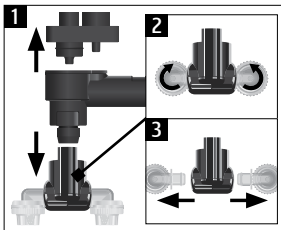

- ▶ Dismantle the milk system into its individual parts.
- ▶ Rinse all the parts under running water. If there are severely dried-on milk residues, firstly immerse the individual parts in a solution of 250 ml cold water and 1 capful of JURA milk system cleaner. Then rinse the parts thoroughly.

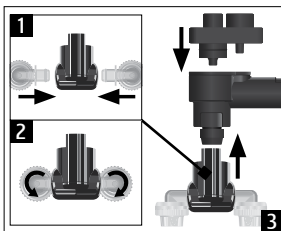

- ▶ Reassemble the milk system.

5 Maintenance

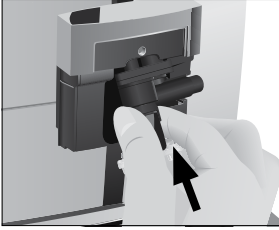

- ▶ Fit the assembled individual parts back in the dual spout and press it firmly.



- ▶ Fit the cover of the dual spout.

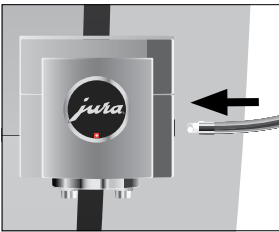

- ▶ Connect the milk pipe to the dual spout.

Changing the filter

- i** After the set amount of water has flowed through the external filter cartridge, it will cease to work. Your GIGA will automatically prompt you to change the filter.

Precondition: The start screen is displayed. 'Change the filter' is displayed.

- ▶ Change the **external** filter cartridge as described in the relevant instructions for use.
- ▶ Touch 'P'.
'Maintenance status'
- ▶ Press the Rotary Switch.
'Clean'
- ▶ Turn the Rotary Switch until 'Change the filter' is displayed.
- ▶ Press the Rotary Switch.
'Do you really want to reset the filter capacity?'

- ▶ Touch **‘Yes’**.
‘Filter capacity in litres:’
 - ▶ Enter the filter capacity of the external filter cartridge.
 - ▶ Touch **‘Save’**.
‘Saved’
- The start screen is displayed. Your GIGA is once more ready for use.

Cleaning the machine

After 220 preparations or 80 switch-on rinses, the GIGA will prompt you to clean it.

CAUTION

If the wrong cleaning agent is used, the machine could be damaged and/or traces could be left behind in the water.

- ▶ Use only original JURA maintenance products.

- i** The cleaning programme lasts approximately 20 minutes.
- i** Do not interrupt the cleaning programme. The quality of cleaning will be impaired if you do so.
- i** JURA cleaning tablets are available from specialised dealers.

Precondition: The start screen is displayed. **‘Clean machine’** is displayed.

- ▶ Touch **‘Clean machine’**.
‘Clean’
- ▶ Touch **‘Clean’**.
- ▶ Touch **‘Start’**.
- ▶ Touch **‘Start’** again.
‘Empty coffee grounds container’
- ▶ Empty the drip tray and coffee grounds container and put them back into the machine.
‘Press the Rotary Switch’
- ▶ Place a receptacle under the dual spout.
- ▶ Press the Rotary Switch.
‘Machine is being cleaned’, water flows out of the dual spout. The operation is interrupted, **‘Add cleaning tablet’**.
- ▶ Open the cover of the filler funnel for ground coffee.



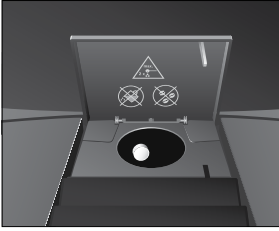

- ▶ Insert a JURA cleaning tablet into the filler funnel.
- ▶ Close the cover of the filler funnel.
'Press the Rotary Switch'
- ▶ Press the Rotary Switch.
'Machine is being cleaned', water flows out of the dual spout repeatedly.
The operation stops automatically.
'Empty coffee grounds container'
- ▶ Empty the drip tray and coffee grounds container and put them back into the machine.
Cleaning is now complete. The start screen is displayed.

Descaling the machine

The GIGA builds up deposits of limescale over time and automatically prompts you to descale it when necessary. The degree of calcification depends on the hardness of your water.

- i** If you use an **external** filter cartridge and this is activated, you will not be prompted to descale.

⚠ CAUTION If the descaling agent comes into contact with the skin or eyes, this can cause irritation.

- ▶ Avoid contact with the skin or eyes.
- ▶ Rinse off the descaling agent with clean water. Should you get any descaling agent in your eye, see a doctor.

CAUTION If the wrong descaling agent is used, the machine could be damaged and/or traces could be left behind in the water.

- ▶ Use only original JURA maintenance products.

CAUTION If the descaling operation is interrupted, there may be damage to the machine.

- ▶ Allow the descaling programme to run to the end.

CAUTION If the descaling agent comes into contact with sensitive surfaces (e.g. marble), damage cannot be ruled out.

- ▶ Clean up any splashes immediately.

-
- i** The descaling programme lasts approximately 50 minutes.
 - i** JURA descaling tablets are available from specialised dealers.

Precondition: The start screen is displayed. 'Decalcify machine' is displayed.

- ▶ Touch 'Decalcify machine'.
- ▶ Touch 'Descalc'.
- ▶ Touch 'Start'.
- ▶ Touch 'Start' again.
- ▶ Empty the drip tray and coffee grounds container and put them back into the machine.

'Empty drip tray'

- ▶ Pour descaling agent into water tank.
- ▶ Completely dissolve 4 JURA descaling tablets in a receptacle holding 800 ml of water. This may take several minutes.
- ▶ Pour the solution into the **empty** water tank and insert it into the machine.

'Press the Rotary Switch'

- ▶ Place one receptacle under the dual spout and another under the hot-water spout.
- ▶ Press the Rotary Switch.

'Machine is being descaled', water flows straight into the drip tray and out of the hot-water spout and dual spout repeatedly.

The operation is interrupted, 'Empty drip tray'.

- ▶ Empty the drip tray and coffee grounds container and put them back into the machine.

'Fill water tank'

- ▶ Empty the receptacles and place them back under the dual spout and the hot-water spout.
- ▶ Remove the water tank and rinse it thoroughly.
- ▶ Fill the water tank with fresh, cold water and reinsert the tank.

'Press the Rotary Switch'

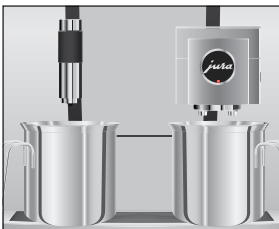
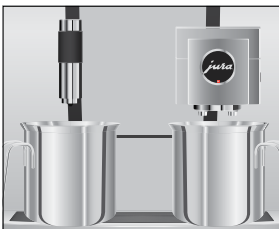
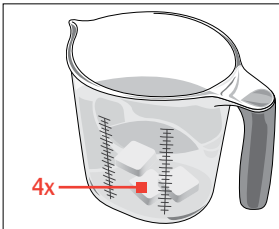

- ▶ Press the Rotary Switch.
‘Machine is being descaled’, the descaling operation is continued. Water flows straight into the drip tray and out of the hot-water spout and dual spout repeatedly.

‘Empty drip tray’

- ▶ Empty the drip tray and coffee grounds container and put them back into the machine.
Descaling is now complete. The start screen is displayed.

i If the descaling operation stops unexpectedly, rinse the water tank thoroughly.

Cleaning the bean container

Coffee beans may be covered with a slight oil film which remains on the walls of the bean container. These traces may negatively affect the coffee result. For this reason clean the bean container from time to time.

- ▶ Press the On/Off button  to switch the GIGA off.
- ▶ Switch the machine off at the power switch.
- ▶ Open the service cover on the back of the machine by pressing above the JURA logo.
- ▶ Push the red sliding catch completely to the rear to close the bean container.

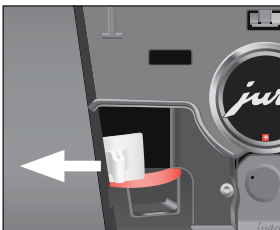
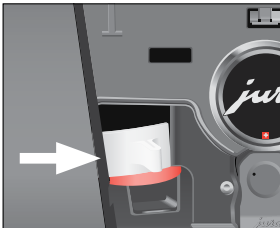

- ▶ Turn the blue locking device outwards.
- ▶ Remove the bean container.
- ▶ Remove the aroma preservation cover.
- ▶ Empty the bean container.
- ▶ Clean the bean container with a soft, dry cloth.
- ▶ Fit the bean container.
- ▶ Turn the blue locking device inwards.
- ▶ Pull the red sliding catch completely forwards.
- ▶ Refit the service cover and fix it by pressing above the JURA logo. It will click into place audibly.
- ▶ Fill the bean container with coffee beans and close the aroma preservation cover.

6 Display messages

Message	Cause/Result	Action
'Empty coffee grounds container' / 'Empty drip tray'	The coffee grounds container is full. / The drip tray is full. You cannot prepare any products.	▶ Empty the coffee grounds container and the drip tray (see Chapter 3 'Daily operation – Daily maintenance').
'Close front cover'	The coffee grounds container cover is open. You cannot prepare any products.	▶ Close the cover.
'Drip tray not fitted'	The drip tray is not inserted correctly or is not inserted at all. You cannot prepare any products.	▶ Fit the drip tray.
'Fill bean container'	The bean container is empty. You can prepare hot water or milk.	▶ Fill the bean container (see Chapter 1 'Preparing and using for the first time – Filling the bean container').
'Clean the milk system'	The GIGA prompts you to clean the milk system.	▶ Perform milk system cleaning (see Chapter 5 'Maintenance – Cleaning the milk system').
'Change the filter'	The external filter cartridge no longer works. The GIGA is prompting a filter change.	▶ Replace the external filter cartridge (see Chapter 5 'Maintenance – Changing the filter').
'Clean machine'	The GIGA is prompting you to clean it.	▶ Perform cleaning (see Chapter 5 'Maintenance – Cleaning the machine').
'Decalcify machine'	The GIGA is prompting you to descale it.	▶ Perform descaling (see Chapter 5 'Maintenance – Descaling the machine').
'Not enough ground coffee'	There is insufficient ground coffee in the machine; the GIGA stops the operation.	▶ The next time you prepare a beverage, add more ground coffee (see Chapter 2 'Preparation – Ground coffee').
'Service cover is not fitted'	The service cover on the back of the machine is not fitted. You cannot prepare any products.	▶ Fit the service cover.

7 Troubleshooting

Problem	Cause/Result	Action
Insufficient foam is produced when the milk is frothed or milk sprays from the dual spout.	The dual spout is dirty.	<ul style="list-style-type: none"> ▶ Clean the milk system in the dual spout (see Chapter 5 'Maintenance – Cleaning the milk system'). ▶ Dismantle and rinse the dual spout (see Chapter 5 'Maintenance – Dismantling and rinsing the dual spout').
	The milk and milk foam temperature is set too high.	<ul style="list-style-type: none"> ▶ Set a lower milk and milk foam temperature for the product.
Coffee only comes out in drips when it is being prepared.	Coffee or ground coffee has been ground too finely and is blocking the system. The water hardness may not have been correctly set.	<ul style="list-style-type: none"> ▶ Put the grinder on a coarser setting or use coarser ground coffee (see Chapter 4 'Permanent settings in programming mode – Setting the consistency of grind'). ▶ Perform descaling (see Chapter 5 'Maintenance – Descaling the machine').
'Fill bean container' is not displayed although the bean container is empty.	The bean monitor is dirty.	<ul style="list-style-type: none"> ▶ Clean the bean container (see Chapter 5 'Maintenance – Cleaning the bean container').
Preparation stops, 'Fill bean container' is briefly displayed although the bean container has been filled.	The sliding catch for the bean container has not been pulled out or has not been pulled out completely.	<ul style="list-style-type: none"> ▶ Open the service cover on the back of the machine and pull the sliding catch all the way out (see Chapter 5 'Maintenance – Cleaning the bean container').
'Empty drip tray' is always displayed.	The metal contacts of the drip tray are dirty or wet.	<ul style="list-style-type: none"> ▶ Clean and dry the metal contacts on the back of the drip tray.
'Error 2' or 'Error 5' is displayed.	If the machine has been exposed to the cold for a long period of time, heating may be disabled for safety reasons.	<ul style="list-style-type: none"> ▶ Warm the machine at room temperature.

Problem	Cause/Result	Action
Other 'Error' messages are displayed.	–	► Switch the GIGA off with the On/Off button  . Contact customer support in your country (see Chapter 11 'JURA contact details / Legal information').

- i** If you were unable to solve the problem, contact customer support in your country (see Chapter 11 'JURA contact details / Legal information').

8 Transport and environmentally friendly disposal

Transport / Emptying the system

Keep the packaging for your GIGA. It should be used to protect the machine during transport.

In order to protect the GIGA from frost during transport, the system must be emptied.

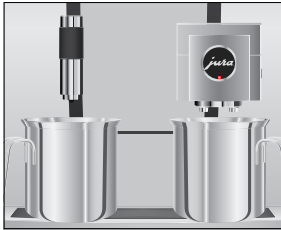

Precondition: The start screen is displayed.

- ▶ Remove the milk pipe from the dual spout.
- ▶ Place one receptacle under the dual spout and another under the hot-water spout.
- ▶ Touch 'P'.

'Maintenance status'

- ▶ Turn the Rotary Switch until 'Machine settings' is displayed.
- ▶ Press the Rotary Switch.

'Machine settings'

- ▶ Move your finger across the display until 'Empty system' is displayed in the centre.

- ▶ Touch 'Empty system'.

'Empty system' / 'Remove the water tank'

- ▶ Remove and empty the water tank.

'Press the Rotary Switch'

- ▶ Press the Rotary Switch.

Water and steam will continue to be discharged from the dual spout and the hot-water spout until the system is empty.

Your GIGA is switched off.

Disposal

Please dispose of old machines in an environmentally neutral way.



Old machines contain valuable, recyclable materials which should be recycled. Please therefore dispose of old machines via suitable collection systems.

9 Technical data

Voltage	Art. 15230	220 – 240 V ~, 50 Hz
	Art. 15311	230 V ~, 50 Hz
	Art. 14012	240 V ~, 50 Hz
Power	Art. 15230	2700 W
	Art. 15311	2300 W
	Art. 14012	2300 W
Airborne noise emitted	L _p < 70 dB (A)	
Ambient conditions	Humidity max. 80% Ambient temperature 10–35 °C	
Conformity mark	CE	
Energy consumption 'Save energy' / '1'	approx. 9 Wh	
Energy consumption 'Save energy' / '0'	approx. 25 Wh	
Pump pressure	static, max. 15 bar	
Holding capacity of water tank	5 l	
Holding capacity of bean container	1000 g	
Holding capacity of coffee grounds container	max. 40 portions	
Cable length	approx. 1.1 m	
Weight	approx. 19.0 kg	
Dimensions (W × H × D)	32 × 55 × 49.7 cm	

Wireless connection:

JURA Smart Connect (Bluetooth connection)	Frequency band 2.4 GHz Max. transmission power < 1 mW
---	--

Technical data for permanent water connection:

Permanent water connection	G 3/4" external thread
Water supply line	Metal hose with G 3/4" union nut (hose must comply with the applicable regulations for your country)
Shut-off valve	with non-return valve (type EA) and filter

Information for testers (repeat test in accordance with DIN VDE 0701-0702): The central grounding point (CGP) is located under the cover of the storage compartment.

10 Index

A

- Addresses 52
- Adjusting the product settings 25
- Aroma preservation cover
 - Bean container with aroma preservation cover 4
- Automatic switch-off 27
 - Timer 29
- Automatic switch-on
 - Timer 29

B

- Bean container
 - Bean container with aroma preservation cover 4
 - Cleaning 42
 - Filling 11
- Black tea 21
- Bluetooth 47
- Bus bar
 - Technical data 47
- Button
 - On/Off button 5
- Bypass amount of water 19

C

- Caffè Barista 19
- Caffè latte 18
- Cappuccino 18
- Cappuccino frother cleaning
 - Cleaning the milk system 36
- Cleaning
 - Bean container 42
 - Machine 39
- Coffee 18
 - Two coffees 18
- Coffee grounds container 4
- Connect accessory 15
- Consistency of grind
 - Setting the consistency of grind 27
- Contact details 52
- Cover
 - Service cover 5
 - Storage compartment 4
 - Water tank 4

- Cup grille 4
- Customer support 52

D

- Daily maintenance 22
- Date 28
- Declaration of Conformity 52
- Descaling
 - Machine 40
- Disable
 - Message display 31
 - One-off settings 31
 - Product selector view 31
 - Product settings 31
- Display
 - Touchscreen display 5, 10
- Display brightness 33
- Display messages 43
- Disposal 46
- Double product 18
- Drip tray 4
 - Insert 4
- Dual spout
 - Dismantling and cleaning 36
 - Height-adjustable dual spout 4

E

- Emptying the system 46
- Energy-saving mode 31
- Errors
 - Troubleshooting 44
- Espresso 18
 - Two espressi 18
- Espresso macchiato 18
- EU Declaration of Conformity 52

F

- Factory settings
 - Restore factory settings 33
- Filler funnel
 - Filler funnel for ground coffee 4
- Filling
 - Bean container 11
- Filter cartridge
 - Changing 38
- First-time use 12
- Flat white 18

G

- Green tea 21
- Grinder
 - Setting the consistency of grind 27
- Ground coffee 19
 - Measuring spoon for ground coffee 4

H

- Homepage 10
- Hotline 52
- Hot water 21
- Hot-water spout
 - Height-adjustable hot-water spout 4

I

- Insert for drip tray 4
- Instant coffee
 - Ground coffee 19
- Internet 10

J

- JURA
 - Contact details 52
 - Internet 10

L

- Language 32
- Latte macchiato 18
- Locking device 5

M

- Machine
 - Cleaning 39
 - Daily maintenance 22
 - Descaling 40
 - Regular maintenance 23
 - Rinsing 35
 - Setting up 11
 - Switching off 23
 - Switching on 22
- Mains cable 4
- Maintenance 35
 - Daily maintenance 22
 - Regular maintenance 23
- Measuring spoon for ground coffee 4
- Messages, display 43

Milk

- Connecting milk 14
- Milk system
 - Cleaning 36
- Milk system rinsing 35

P

- Permanent settings in programming
 - mode 24
- Pot of coffee 18
- Power switch 4
- Preparation 16, 18
 - At the touch of a button 16
 - Black tea 21
 - Caffè latte 18
 - Cappuccino 18
 - Coffee 18
 - Espresso 18
 - Espresso macchiato 18
 - Flat white 18
 - Green tea 21
 - Ground coffee 19
 - Hot water 21
 - Latte macchiato 18
 - Lungo Barista 19
 - Pot of coffee 18
 - Ristretto 18
 - Two coffees 18
 - Two espressi 18
 - Two ristretti 18
 - Two speciality coffees 18
 - Using the product selector 16
- Preparation options 16
- Problems
 - Troubleshooting 44
- Product selector view 16
- Product settings 25
 - Adjusting 25
- Programming mode 24
 - Automatic switch-off 27
 - Disabling functions 31
 - Display brightness 33
 - Energy-saving mode 31
 - Language 32

- Product settings 25
 - Querying information 34
 - Restore factory settings 33
 - Setting the consistency of grind 27
 - Setting the water hardness 29
 - Time and date 28
 - Timer 29
 - Unit for amount of water / time format 30
 - Proper use 6
- Q**
- Querying information 34
- R**
- Regular maintenance 23
 - Rinsing
 - Machine 35
 - Ristretto 18
 - Two ristretti 18
 - Rotary Selection 16
 - Rotary Switch 5, 10
- S**
- Safety 6
 - Safety information 6
 - Service cover 5
 - Service socket 5
 - Settings
 - Permanent settings in programming mode 24
 - Setting up
 - Setting up the machine 11
 - Short operating instructions 10
 - Sliding catch 5
 - Smart Connect 5, 15
 - Spout
 - Height-adjustable dual spout 4
 - Height-adjustable hot-water spout 4
 - Switching off 23
 - Timer 29
 - Switching on 22
 - Timer 29
 - Switch-off
 - Automatic switch-off 27
 - Switch-off time 29
 - Switch-on time 29
 - Symbol description 3

- T**
- Technical data 47
 - Tel 52
 - Time 28
 - Time format
 - Programming mode 30
 - Timer 29
 - Touchscreen display 5, 10
 - Transport 46
 - Troubleshooting 44
 - Two products 18

- U**
- Unit for amount of water
 - Programming mode 30
 - Use, First-time 12

- V**
- Ventilation slats 4
 - Venti Ports
 - Ventilation slats 4

- W**
- Water hardness
 - Determining the water hardness 12
 - Setting the water hardness 29
 - Water tank 4
 - Website 10
 - Wireless connection 15, 47

11 JURA contact details / Legal information

Your JURA service partner

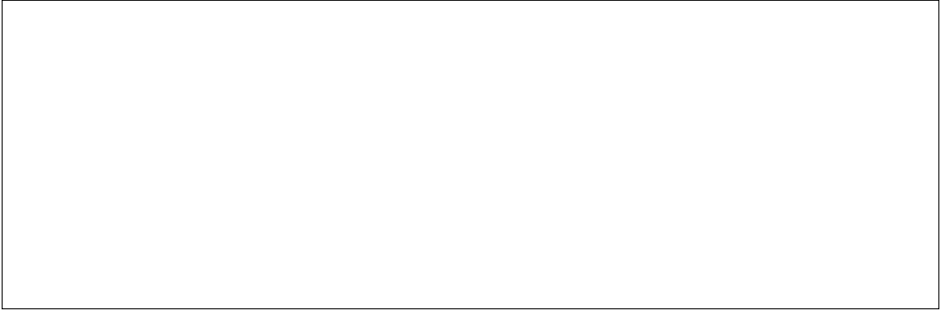

JURA Elektroapparate AG
Kaffeeweltstrasse 10
CH-4626 Niederbuchsiten
Tel. +41 (0)62 38 98 233
www.jura.com

- Directives** The machine complies with the following directives:
- 2006/42/EC – Machinery Directive
 - 2014/30/EU – Electromagnetic Compatibility
 - 2009/125/EC – Ecodesign Directive
 - 2011/65/EU – RoHS Directive
 - 2014/53/EU – Wireless Voltage Directive

A detailed EU Declaration of Conformity for your GIGA can be found at www.jura.com/conformity.

- Technical changes** We reserve the right to make technical changes. The diagrams used in these instructions for use are for illustration purposes only and do not represent the original colours of the machine. Some details of your GIGA may vary.

- Feedback** Your opinion is important to us! Use the contact details at www.jura.com.

- Copyright** The instructions for use contain information which is protected by copyright. It is not permitted to photocopy these instructions for use or translate them into another language without the prior written consent of JURA Elektroapparate AG.