

MGR MGR-2

DIGITAL GATE RECEIVER

Installation Instructions

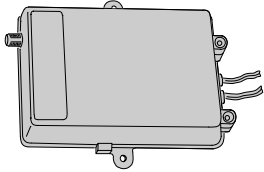

Linear

(760) 439-7000
USA & Canada (800) 421-1587 & (800) 392-0123
Toll Free FAX (800) 468-1340
www.linearcorp.com

STEP 1 Connect receiver relay output

Connect the appropriate channel wires (Ch. 1 - two gray wires), (Ch. 2 - two yellow wires) to the appropriate activation terminals on the gate operator.

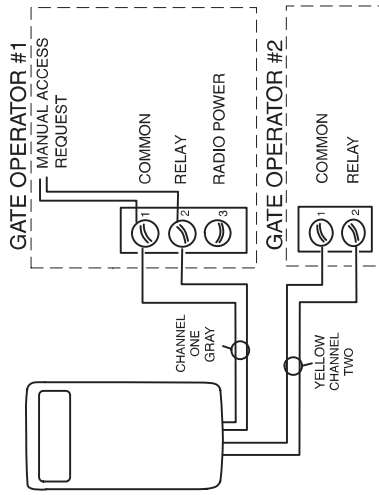

STEP 4 Connect antenna

Connect the coaxial cable to the "F" connector on the receiver. Drill a 3/8" hole on the top of the operator housing for the bulkhead connector. Insert the connector and secure it with the nut and lock washer. Connect the cable and antenna to the bulkhead connector.

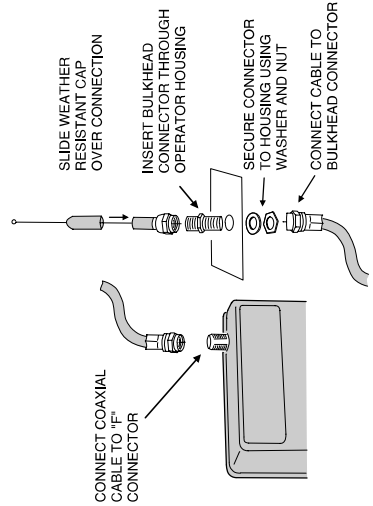

Description

The MegaCode series of digital receivers are wireless radio controls designed for use with automatic gate openers or garage door operators. The MegaCode radio format provides unparalleled security. The transmitter and receiver can be programmed to more than a million different codes. MegaCode receivers and transmitters do not contain a typical "coding switch". Each transmitter is pre-set at the factory to a unique code. The receiver is programmed by sending a signal to it from the transmitter(s) that are going to be used with it. This stores the transmitters code into the receiver's memory. The receiver will retain its memory even without power. The receiver will activate only from these "memorized" transmitters. **Each MegaCode receiver can remember a maximum of 40 transmitters.**

The receivers can operate from 12-30 volts AC or 10.5-30 volts DC and are normally powered from the gate operator. The relay contact(s) are rated at 5 amps @ 32 volts AC/DC NEC Class 2 circuit.

STEP 2 Connect receiver to power

Connect the red power input wire to the radio power and the black wire to the common terminal on the gate operator.

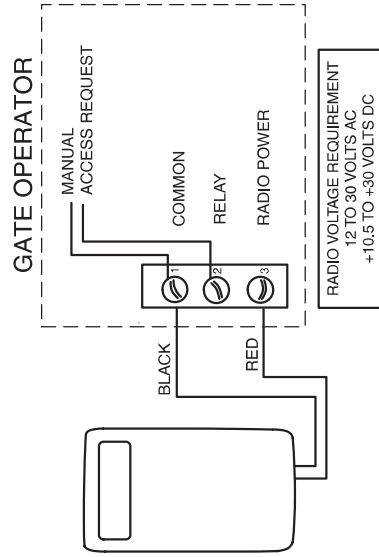

STEP 5 Open receiver case

To open the receiver case, remove the screws, squeeze sides of case and rotate upward.

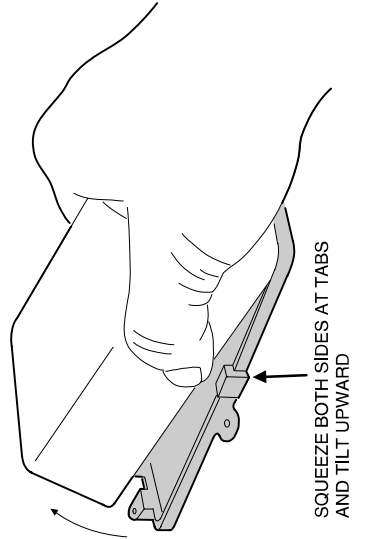

The MGR series has an "F" connector for attaching an antenna. The receiver is supplied with a 9-inch local antenna, a three foot 75 ohm coaxial cable, and a bulkhead connector for mounting the antenna outside the gate operator enclosure

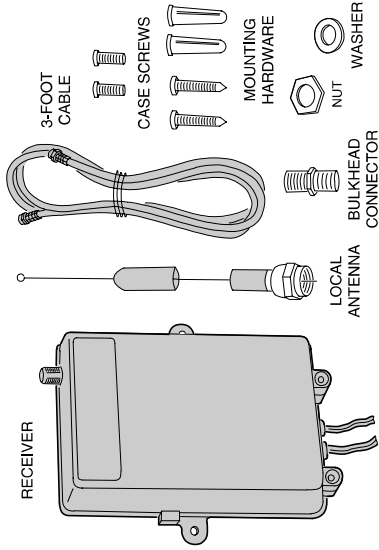

STEP 3 Mount the receiver

Use the screws provided to mount the receiver within the operator housing. This provides protection from the elements. Secure case with case screws.

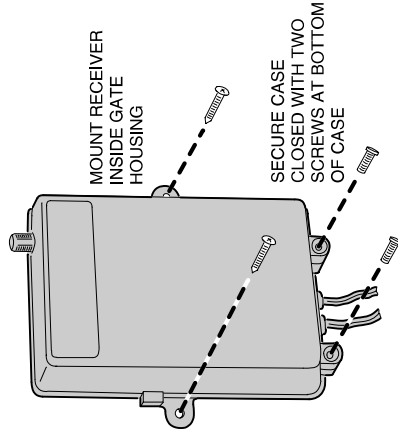

STEP 6A MGR & MGR-2 channel one code switch

The pushbutton labeled S1 is used to program transmitters to channel one.

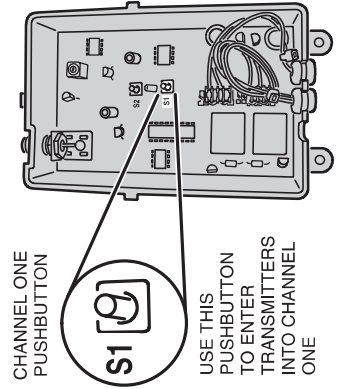

STEP 6B MGR-2 channel two code setting

The pushbutton labeled S2 is used to program transmitters to channel two.

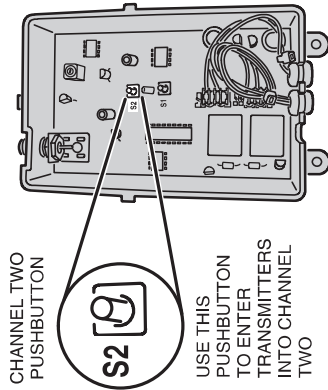

CHANNEL TWO
PUSHBUTTON

USE THIS
PUSHBUTTON
TO ENTER
TRANSMITTERS
INTO CHANNEL
TWO

STEP 7 Program the receiver

Momentarily press the receiver's program button. The red programming LED will light if there's room in the receiver's memory for another transmitter (40 maximum per receiver). The LED stays on for about 5 seconds. **A transmitter must be entered while the LED is on.** Press the desired transmitter button. The LED will flicker indicating that the receiver has accepted the transmitter

NOTE: be sure to press the receiver program button for less than 2 seconds.

WARNING! Operator will not activate when the receiver is being programmed from the transmitter, but will activate the next time the transmitter is activated after programming.

NOTE: The programming LED also monitors radio signals entering the receiver. It is common to see an occasional blink from the LED. The LED will also light when any transmitter tuned to the receiver's frequency (programmed into the receiver or not) is activated.

MOMENTARILY PRESS THE PUSHBUTTON FOR THE DESIRED CHANNEL (S1 or S2)

THE LED WILL LIGHT AND REMAIN ON ABOUT FIVE SECONDS

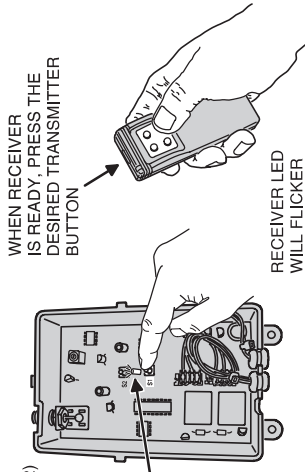

RECEIVER LED WILL FLICKER AS TRANSMITTER IS ENTERED INTO MEMORY

STEP 8 Add additional transmitters

Repeat Step 7 for each transmitter used with this receiver. Be sure to press the receiver's program button **each time a new transmitter or a different transmitter button on a multi-button transmitter is pressed.** If the LED doesn't come on when the receiver's program button is pressed, the receiver's memory is full (40 transmitters total). Use the erase function (Info 1) to remove transmitters from the receiver's memory.

PRESS PROGRAM BUTTON FIRST

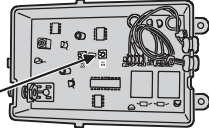

THEN PRESS TRANSMITTER BUTTON

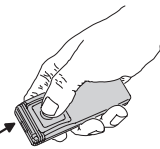

WITH MULTI-BUTTON TRANSMITTERS, PRESS THE DESIRED BUTTON

STEP 9 Review memory

Press and hold the receiver's program button until the LED begins to flash (about 3 seconds) and then release the button. Count the number of flashes. The number of flashes equals the number of transmitters programmed into the receiver

NOTE: Don't hold down the programming button longer than 5 seconds or the receiver's memory for that channel will be erased (Info 1).

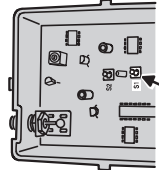

PRESS PROGRAM BUTTON FOR THREE SECONDS THEN RELEASE

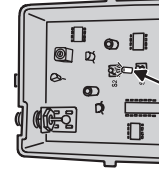

LED WILL FLASH, COUNTING THE TOTAL NUMBER OF TRANSMITTERS PROGRAMMED

STEP 10 Test receiver

Be sure gate area is clear. Activate each transmitter. The receiver relay should click and the operator should activate. Wait 1 second between each activation.

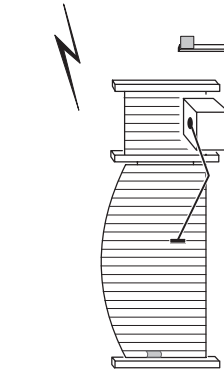

WARNING! BE SURE GATE AREA IS CLEAR OF OBSTRUCTIONS

PRESS TRANSMITTER BUTTON TO TEST

NOTE: If the receiver's LED flashes continuously when a transmitter isn't being activated, the receiver is too close to an electrical noise source. Move the receiver away from the noise source or call technical services for assistance. (The receiver must be open to observe this.)

INFO 1 Erasing receiver memory

Transmitters may be erased from the receiver's memory by pressing and holding the receiver's program button until the LED blinks (count of transmitters) and then blinks one more time (Channel 1) or two more times (Channel 2) as the receiver's memory is erased. **All transmitters are erased at the same time.** Then release the program button.

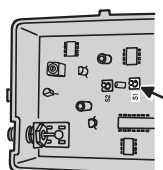

PRESS PROGRAM BUTTON FOR FIVE SECONDS OR MORE

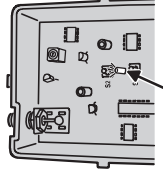

LED WILL FLASH, COUNTING THE TOTAL NUMBER OF TRANSMITTERS PROGRAMMED. THEN IT WILL BLINK ONCE (CHANNEL ONE) OR TWICE (CHANNEL TWO) AS THE TRANSMITTERS ARE ERASED

LIMITED WARRANTY

This Linear product is warranted against defects in material and workmanship for twelve (12) months. The Warranty Expiration Date is labeled on the product. This warranty extends only to wholesale customers who buy direct from Linear or through Linear's normal distribution channels. Linear does not warrant this product to consumers. Consumers should inquire from their selling dealer as to the nature of the dealer's warranty, if any. There are no obligations or liabilities on the part of Linear LLC for consequential damages arising out of or in connection with use or performance of this product or other indirect damages with respect to loss of property, revenue, or profit, or cost of removal, installation, or reinstallation. All implied warranties, including implied warranties for merchantability and implied warranties for fitness, are valid only until Warranty Expiration Date as labeled on the product. This Linear LLC Warranty is in lieu of all other warranties express or implied.

All products returned for warranty service require a Return Product Authorization Number (RPA#). Contact Linear Technical Services at 1-800-421-1587 for an RPA# and other important details

IMPORTANT!!!

Linear radio controls provide a reliable communications link and fill an important need in portable wireless signaling. However, there are some limitations which must be observed.

- * For U.S. installations only: The radios are required to comply with FCC Rules and Regulations as Part 15 devices. As such, they have limited transmitter power and therefore limited range.
- * A receiver cannot respond to more than one transmitted signal at a time and may be blocked by radio signals that occur on or near their operating frequencies, regardless of code settings.
- * Changes or modifications to the device may void FCC compliance.
- * Infrequently used radio links should be tested regularly to protect against undetected interference or fault.
- * A general knowledge of radio and its vagaries should be gained prior to acting as a wholesale distributor or dealer, and these facts should be communicated to the ultimate users.