

## Outdoor Wave-to-Open Sensors

- SD-9163-KSQ** Slimline, English\*
- SD-9163-KSVQ** Slimline, English\*, Manual Override
- SD-9263-KSQ** Single-Gang, English\*
- SD-9263-KSVQ** Single-Gang, English\*, Manual Override

The ENFORCER Outdoor Wave-to-Open Sensor is a full-featured exit plate which uses IR technology to allow egress from a protected area or activate a device with the simple wave of a hand. Since no touch is required, this sensor is suitable for use in hospitals, clinics, labs, cleanrooms (to reduce the risk of contamination), schools, factories, or offices.



SD-9163-KSQ



SD-9163-KSVQ

### Features:

- Weather-resistant (IP65) for outdoor use†
- Clean and simple no-touch operation reduces the risk of cross-contamination
- Adjustable sensor range up to 7" (18cm)
- Stainless steel plate, available in slimline or single-gang
- 1.2A relay, adjustable trigger duration 0.8~30 seconds
- Selectable LED colors (turns from red to green or green to red) to show if the sensor is activated

### SD-9163-KSVQ and SD-9263-KSVQ only:

- Manual override button functions without electricity in case of power failure



SD-9263-KSQ



SD-9263-KSVQ

### Specifications:

Operating voltage		12~24 VDC
Power consumption	Standby	16mA@12VDC / 25mA@24VDC
	Triggered	20mA@12VDC / 32mA@24VDC
Relay type		Form C dry contact, 1.2A@24VDC
Response time		10mS
Output time		0.8~30s, toggle
Range		2"~7" (5~18cm)
IP Rating		IP65†
Operating temperature		-4°~131° F (-20°~55° C)
Dimensions	Slimline	1 1/2"x4 1/2"x1 1/2" (39x115x39 mm)
	Single-gang	2 3/4"x4 1/2"x1 1/2" (70x115x39 mm)

### Sample Installation:

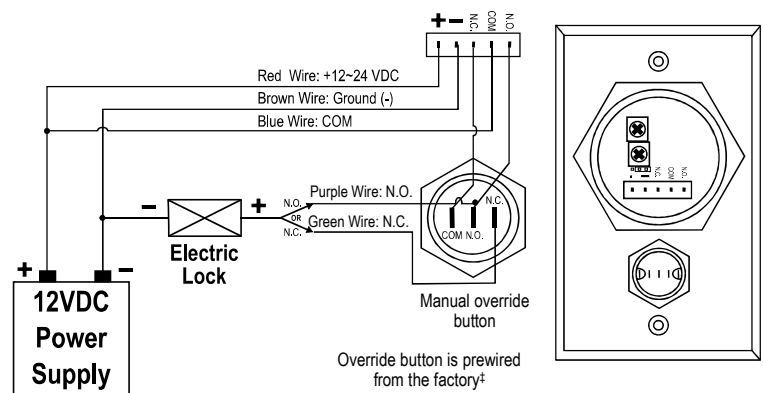

\*Also available with Spanish or French faceplates

†When properly installed.

‡SD-9163-KSVQ and SD 9263-KSVQ only

## SECO-LARM® U.S.A., Inc.

16842 Millikan Avenue, Irvine, CA 92606

Phone: (949) 261-2999 | (800) 662-0800 Fax: (949) 261-7326







Website: www.seco-larm.com Email: sales@seco-larm.com





Copyright © 2020 SECO-LARM U.S.A., Inc. All rights reserved. All trademarks are the property of SECO-LARM U.S.A., Inc. or their respective owners. The SECO-LARM policy is one of continual development. For that reason, SECO-LARM reserves the right to change prices and specifications without notice. SECO-LARM is not responsible for misprints.

**SECO-LARM® ENFORCER® CRIMEBUSTER® CBA® SLI®**



**Ordering Information:**

Outdoor Wave-to-Open Sensors*						
Model	SD-9163-KSQ	SD-9263-KSQ	SD-9163-KS1Q	SD-9263-KS1Q	SD-9163-KS2Q	SD-9263-KS2Q
Language	English		Spanish		French	
Photo						

\*Also available with European faceplate in English, Spanish, and French models

Outdoor Wave-to-Open Sensors with Override Button			
Model	SD-9163-KSVQ	SD-9263-KSVQ	SD-9463-KSVQ
Language	English†		
Photo			

†Spanish and French faceplates available by special order

Outdoor Wave-to-Open Sensors – Other Models		
Model	SD-9963-KSGQ	SD-9773-KNEVQ
Type	Post-Mount	Surface-Mount
Photo		

**Other Models Also Available**  
**For our full line of OEM/private label infrared sensors, contact SECO-LARM**