

ENFORCER[®]

SA-027HQ 365-Day Annual Timer

Manual



- Two N.O. or N.C. Form C relays, 10A@14VDC
- Each relay can be programmed for 50 events, for a total of 100 individual programmable events
- 10 Programmable holidays
- The 100 programmable events can be set weekly, daily, or hourly, over the course of an entire year
- Password protection can be turned ON or OFF
- One egress input per relay (2 total)

ENFORCER 365-Day Annual Timer

Table of Contents:

Introduction	2	Programming Worksheet.....	6-7
Features	2	Programming Holidays	8
Specifications	3	Clearing Memory	8
Parts List	3	Setting Block Programming and Time Settings.	8
Overview	3	Programming Password	9
Installation	3	Using Password Protection	9
Function Buttons	3	Password Reset	9
Relay Options.....	4	Programming Menu Flowchart	10
Programming Key	4	Wiring Diagram.....	11
Programming Notes	4	Using 2 Relays in Tandem	11
Setting Time and Date	5	Wireless Operation	12
Programming Events.....	5	Warranty.....	12

Introduction:

The ENFORCER SA-027HQ Annual Timer can be programmed to operate two relays 24 hours a day, over the course of an entire year. These relays can be used to control devices in many applications such as security, access control, lighting, and environmental control. The two Form C relays can each be programmed to operate in shunt or momentary mode for up to 50 unique events. Each event can be programmed on a weekly or daily schedule. Block programming allows events to be repeated on consecutive days. 10 Programmable holidays disable the timer for a single day, or for the same day every year.

Features:

- Two N.O. or N.C. Form C relays 10A@14VDC.
- Each relay can be programmed for 50 events, for a total of 100 individual programmable events.
- The 100 programmable events can be set weekly, daily, or hourly, over the course of an entire year.
- Password protection can be turned ON or OFF.
- One egress input per relay (2 total).
- Block programming allows events to be repeated on consecutive days.
- First-person-in function interrupts the normal operation of the annual timer.
- Event outputs can be programmed disable, ON, OFF, shunt, or momentary (1~99 seconds).
- 10 Programmable holidays.
- Can be programmed for password protection.
- Tandem mode allows both relays to operate simultaneously.
- EEPROM Memory for safe data protection in case of power failure.
- Built-in clock backup battery.
- Built-in backup battery charger for external backup battery use.
- Compensates for leap years.
- Can be set for Standard or Daylight Saving Time.
- Alphanumeric backlit LCD display for easy programming.

ENFORCER 365-Day Annual Timer

Specifications:

Input voltage	12~24 VDC/VAC	
Number of relays	2	
Relay rating	10A@14VDC	
Current draw	100mA	
Number of prog. events	50 for each relay, 100 total	
Blue LED	ON	Power is ON
	OFF	Power is OFF
Number of prog. holidays	10	
Battery charging current	90mA	
Security code	4-digits, numeric, ON/OFF	

Parts List:

- 1x 365-Day Timer
- 1x Manual
- 2x Screws
- 2x Back-up battery wires

Overview:

SA-027HQ Annual Timer

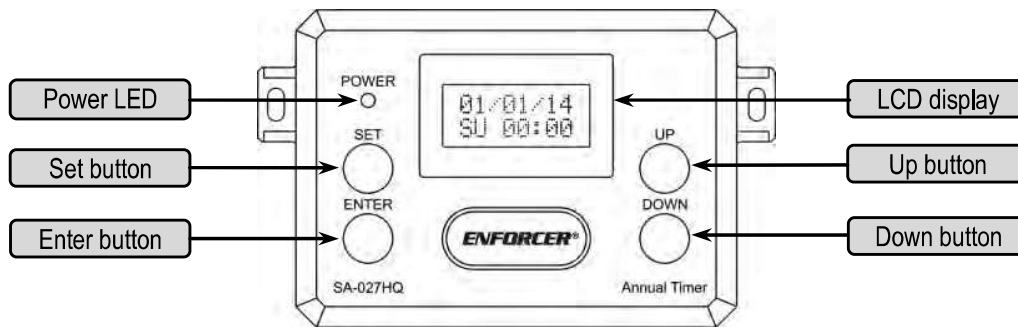

Installation:

1. Find a location for the SA-027HQ where the LCD display is easily seen and the buttons can be pressed. Mark that location.
2. Open the case and connect the wires.
3. Connect a 12/24 VDC/VAC power supply to the power input terminals marked (+) and (-).
4. Connect the battery backup to the backup battery input terminals marked (+) and (-).

NOTE: For the best backup battery charging results, the power input should not be lower than 17VDC or 12VAC.

5. Remove the paper battery protector from the onboard clock backup battery.

NOTE: The paper protector prevents the battery from being drained during product shipment. If the protector is not removed, the onboard clock backup battery will fail to function.
6. Connect the devices that are being controlled to the outputs of one or two relays.

NOTE: If using a DC-powered electric/electromagnetic lock, connect a 1N4004 diode in parallel with the power supply and as close to the lock as possible. This absorbs possible interference and prevents operation of the lock from damaging the timer. Not required for AC-powered locks.
7. Close the case and mount the unit.

Function Buttons

The SA-027HQ has 4 function buttons that control the programming features.

Table 1: Function Buttons

SET	Enters the main menu, backs out of a submenu
ENTER	Enters a submenu, accepts the current value above the cursor
UP	Changes the menu selection or the value above the cursor
DOWN	Changes the menu selection or the value above the cursor

ENFORCER 365-Day Annual Timer

Relay Options:

1. Press the UP or DOWN button while the main screen is on to show the relay status screen.
 - a. Press and hold the UP button for 3 seconds to toggle relay 1.
 - b. Press and hold the DOWN button for 3 seconds to toggle relay 2.
2. See Table 2 below for different event modes available under Event programming

Table 2: Event Modes

Disable	Disables the event (factory default)
ON	Turns the relay ON
OFF	Turns the relay OFF
Pulse	Activates the relay for 1~99 secs.

Programming Key:

BK	Block Coding	HOL	Holiday
ON	Relay will switch on	MO	Monday
OFF	Relay will switch off	TU	Tuesday
DIS	Relay will be disabled	WE	Wednesday
PL	Relay will pulse for a # of seconds	TH	Thursday
DS	Daylight Saving Time*	FR	Friday
ST	Standard Time	SA	Saturday
R1	Relay 1	SU	Sunday
R2	Relay 2		

For an explanation of Daylight Saving Time, please see page 8.

Programming Notes:

A convenient feature of the SA-027HQ Annual Timer is the ability to program it before installation. The EEPROM memory stores and protects programming instructions.

Programming the SA-027HQ is easier and faster if you know exactly how you want to use the Annual Timer, as well as functions it will perform.

1. Following the programming instructions in order will make installation easier.
2. Determine which relays will operate the devices that are being controlled.
3. Determine if two relays will be used in tandem.
4. Determine if Daylight Saving Time or Standard Time will be used. For a full explanation, see Setting Block Programming and Time Settings on page 8.
5. Using a separate piece of paper, write down the following:
 - a. The days to be block coded. For example: Monday through Friday or Sunday and Monday.
 - b. All the events you want to program, as well as their duration (up to 50 per relay).
 - c. Any holidays you wish to program to override the programmed events (up to 10).
6. Decide whether you will use a password or not, and what the password will be. For password operation, see page 9.
7. To reset the password, see Password Reset on page 9.

ENFORCER 365-Day Annual Timer

Setting the Time and Date:

1. To set the time and date, press the SET button on the SA-027HQ until "ENTER TO SET TIME" appears on-screen. Press the ENTER button to confirm the programming selection.

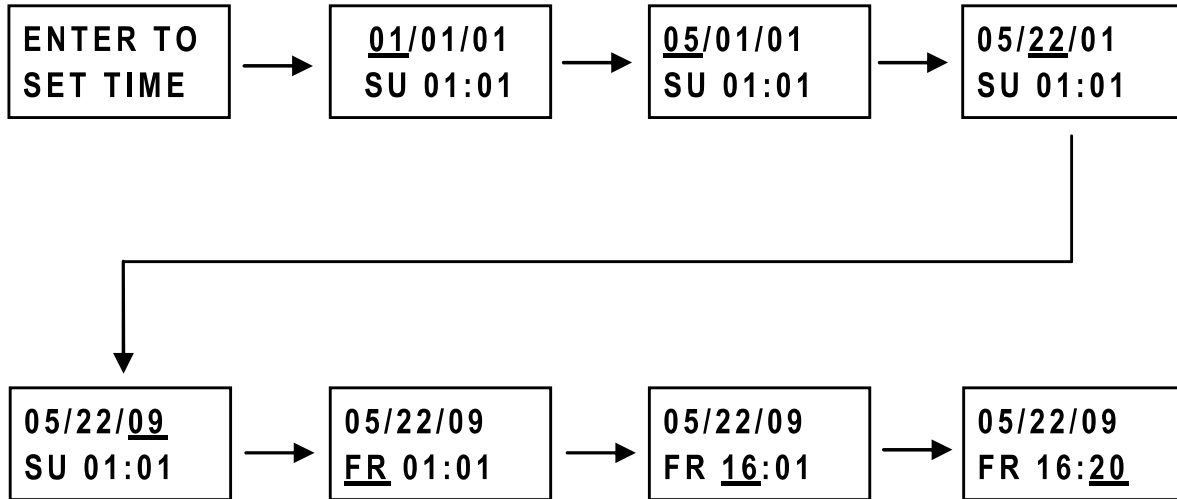

2. Press the UP or DOWN button to enter the correct month, date, and year.
3. Press the UP or DOWN button to enter the correct day of the week, hour, and minute.
4. Press the ENTER button to confirm a selection, or press the SET button to go back to the previous selection.

NOTE: Time is shown using the 24-hour format. For example, 5:30 AM is shown as 05:30, while 5:30 PM is shown as 17:30.

Programming Events:

1. To set events, press the SET button on the SA-027HQ until "ENTER TO SET EVNT" appears on-screen. Press the ENTER button to confirm the programming selection.

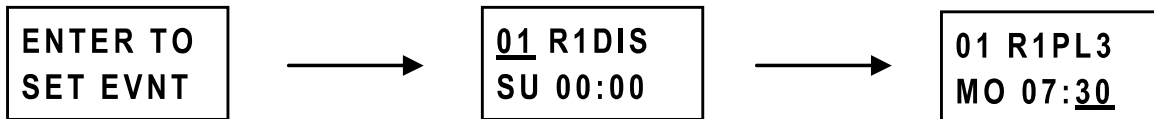

2. Press the UP or DOWN button to enter the event number, the relay number and how the relay will operate, and the day and time the event is scheduled. Refer to Programming Key on page 4.
3. Below are some examples of how each event can be programmed:

01R1PL45
WE 12:45

Event #1, Relay #1
Pulse 45 secs
Wednesday only
Occurs at 12:45

29 R2ON
BK 07:55

Event #29, Relay #2
Relay ON
Block programming
Occurs at 07:55

30 R2OFF
BK 17:05

Event #30, Relay #2
Relay OFF
Block programming
Occurs at 17:05

50 R1DIS
SU 08:00

Event #50, Relay #1
No Relay Output
Sunday only
Occurs at 08:00

ENFORCER 365-Day Annual Timer

Programming Holidays:

1. To set holidays for suspending normal operation of the timer, press the SET button on the SA-027HQ until "ENTER TO SET HOL" appears on screen. Press the ENTER button to confirm the programming selection.

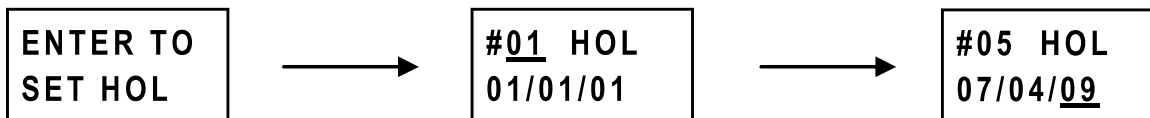

2. Press the UP and DOWN buttons to enter the holiday number and the date the timer will suspend normal operation. Press the ENTER button to confirm the programming selection.
3. To set a holiday for suspending normal operation of the timer every year, set the year to XX.

Note: Please be aware that most holidays occur on different days of the week in different years. For example, if New Year's Day occurs on Sunday, January 1st, a workplace will be typically closed on Monday, January 2nd. Note this when programming a holiday with the XX option.

Clearing the Memory:

1. To clear the memory, press the SET button on the SA-027HQ until "ENTER TO CLR MEMO" appears on-screen. Press the ENTER button to confirm the programming selection.

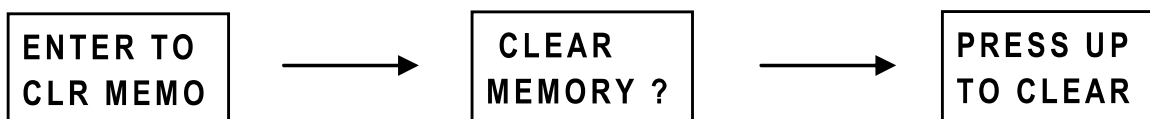

2. Using the function buttons, press the ENTER button to confirm you want to clear the memory.
3. Using the function buttons, press the UP button to clear the memory.

Setting Block Programming and Time Settings:

1. To set block events, press the SET button on the SA-027HQ until "ENTER TO SET BK" appears on screen.

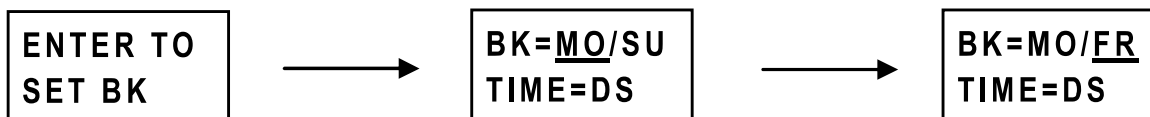

2. Pressing the ENTER button will confirm the programming selection.
3. Using the function buttons, press UP or DOWN to enter in the first day of consecutive days you want an event to repeat, press the ENTER button to confirm the programming selection.
4. Using the function buttons, press UP or DOWN to enter in the last day of consecutive days you want an event to repeat. Press the ENTER button to confirm the programming selection.
5. Using the function buttons, press UP or DOWN to switch between Daylight Saving Time (DS) or Standard Time (ST) format. For more information see the note below.

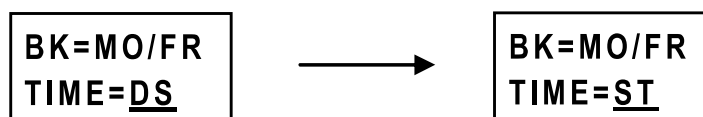

Note: The SA-027HQ follows U.S. Daylight Saving Time (DST) standards. DST begins at 2:00 a.m. local time (add one hour) on the 2nd Sunday of March and switches back to Standard Time at 2:00 a.m. local time (subtract one hour) on the 1st Sunday in November.

ENFORCER 365-Day Annual Timer

Programming Password:

1. To set the password, press the SET button on the SA-027HQ until "ENTER TO SET CODE" appears on-screen. Press the ENTER button to confirm the programming selection.

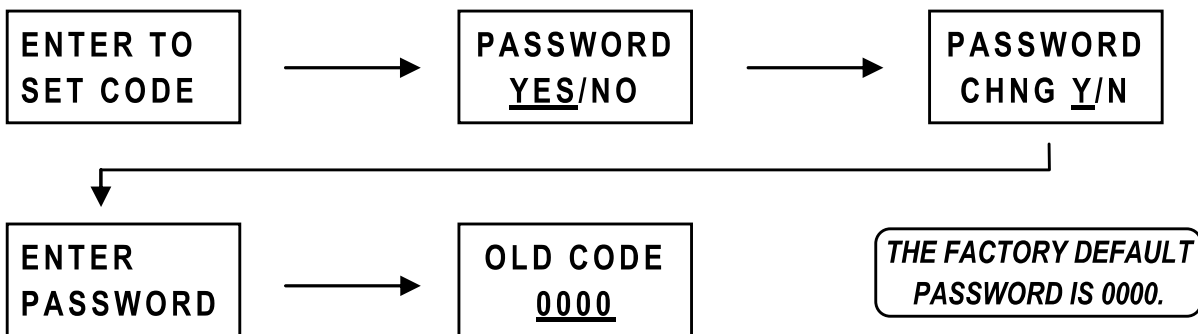

2. Using the UP and DOWN buttons, select "YES" or "NO". Press the "ENTER" button to confirm the selection. A confirmation screen will appear. Select "Y" to set the password or "N" to go back.
3. Using the UP and DOWN buttons, enter in the password you are changing.

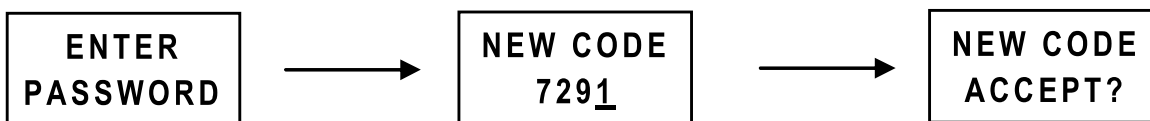

4. If the password is correct, use the UP and DOWN buttons to set a new password.
5. After entering the new password, press the ENTER button to accept the new password.

Using Password Protection:

1. If the password protection is set, the password must be entered every time programming mode is entered.

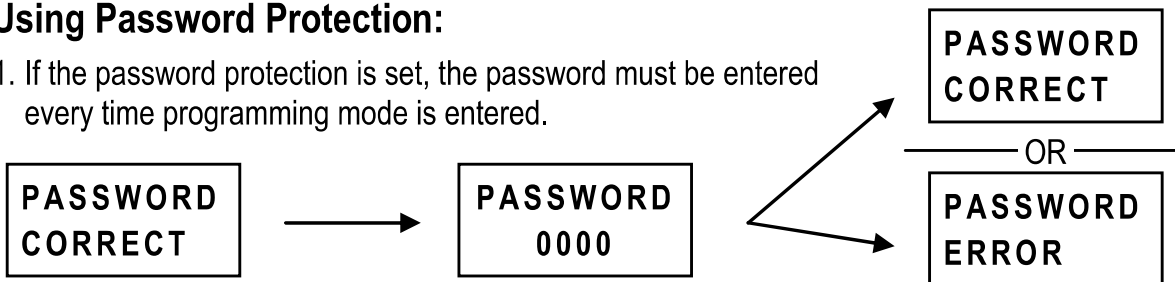

Password Reset:

1. Disconnect power from the SA-027HQ. If installed, remove the back-up batteries.
2. Within 30 seconds after power is reconnected, press all four function buttons (UP, DOWN, SET, and ENTER) at the same time for approximately 5 seconds. **If the buttons are not pressed within 30 seconds, then the SA-027HQ will be unable to reset the password.**
3. After the four function buttons are pressed for 5 seconds, "PASSWORD RESET" will appear for 1 second, followed by "NEW PSWD 0000" for 1 second, and then "ENTER PASSWORD".

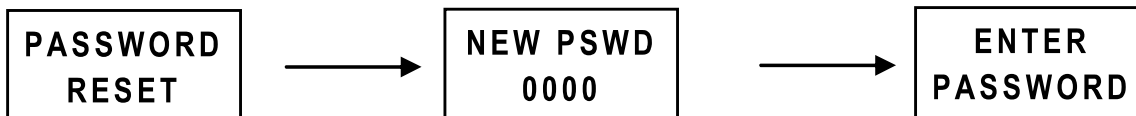

4. The password has now been restored to the factory default setting 0000.
5. Within 1 min. after "ENTER PASSWORD" is displayed, enter the new password. If no password is entered, the SA-027HQ will exit password programming mode automatically.
6. No other programming changes have been reset, only the password.
7. For added security, it is recommended to change the password immediately.

Programming Menu Flowchart:

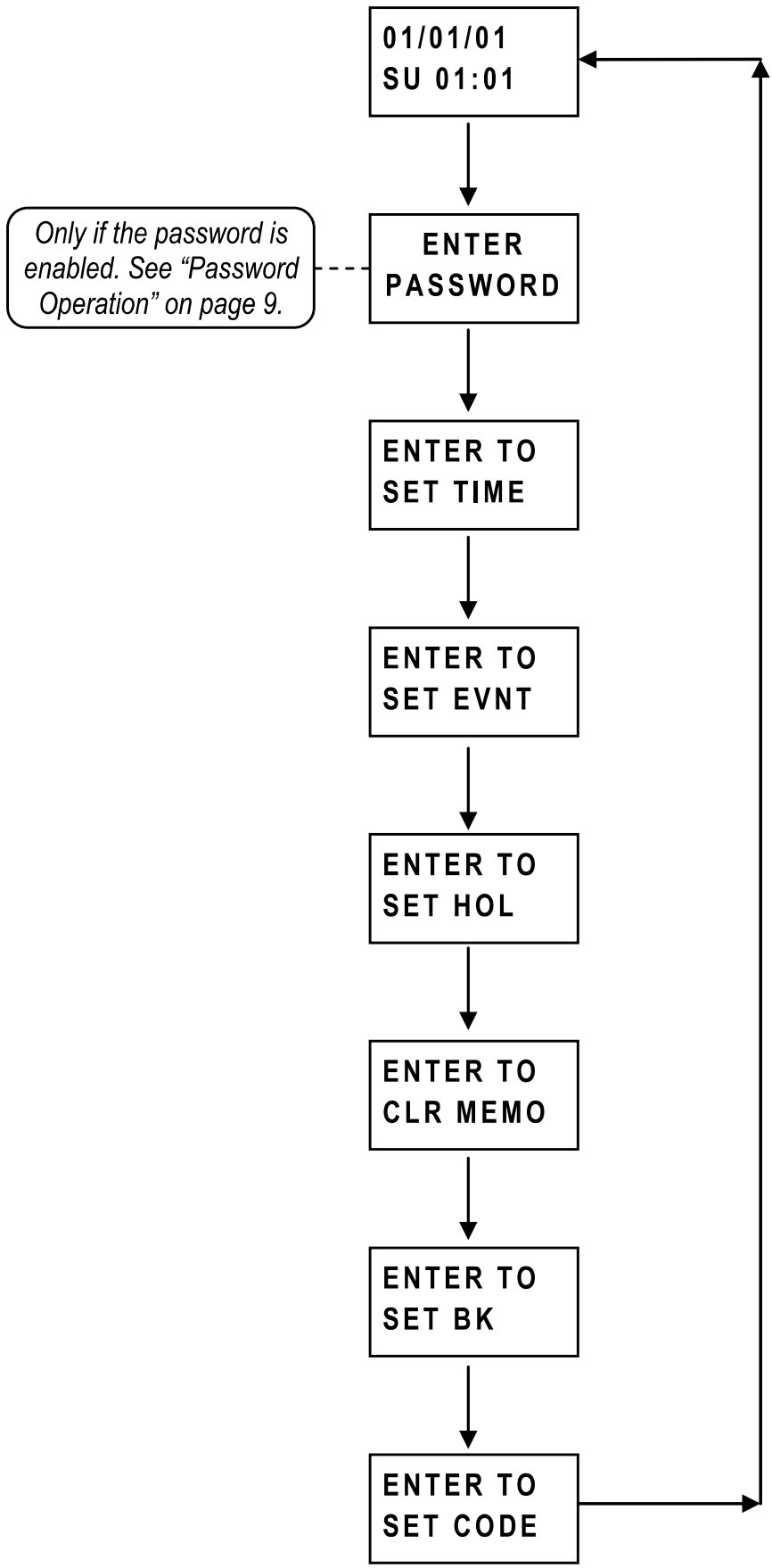

ENFORCER 365-Day Annual Timer

Using 2 Relays in Tandem:

The SA-027HQ can be configured so that both relays operate at the same time.

By setting the jumper to the "ON" position, the timer will output on both relays whenever an event is programmed for either Relay #1 or Relay #2 (factory default is set to OFF).

Tandem Jumper marked JP01:

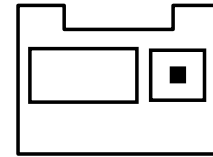

ON OFF

	ON	OFF
JP01	Tandem output	No tandem output

Wiring Diagram:



IMPORTANT: When connecting to a backup battery, the input voltage needs to be 17~24VDC or 12~24VAC ONLY. An unregulated 12VDC adapter (ST-1212-U0.5A) is acceptable.

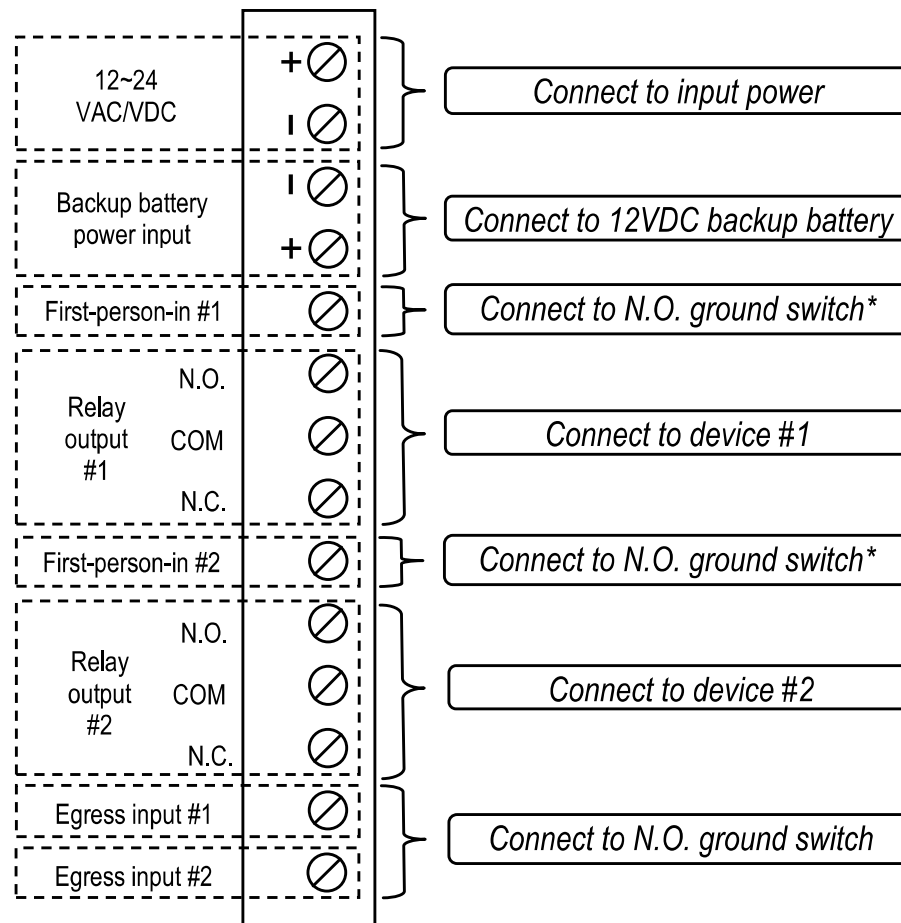

* When the optional N.O. switch is activated, the first-person-in function suspends the operation of the SA-027HQ annual timer. If a relay is turned on before the first-person-in feature is activated, the relay will remain on until the first-person-in feature is deactivated. Once deactivated by turning the switch off, the timer will turn on the last programmed function prior to the first-person-in activation.

ENFORCER 365-Day Annual Timer

Sample Application:

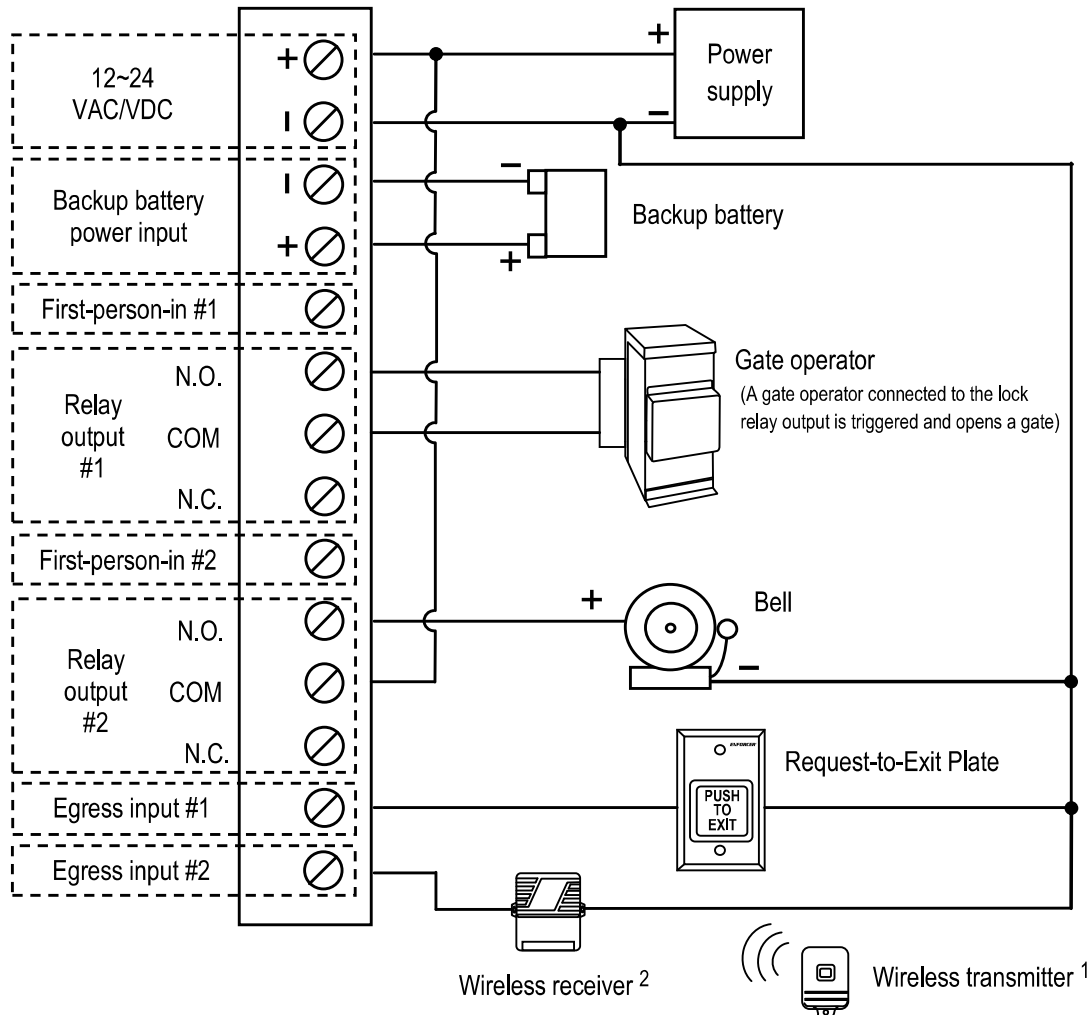

¹ A wireless initiate device, such as the SK-919TD1S-UP, is triggered.

² A wireless receiver, such as the SK-910RBQ receives the signal. The receiver's common terminal is connected to a positive voltage and the normally closed terminal is connected to the SA-025EQ's initiate input.

WARRANTY This SECO-LARM product is warranted against defects in material and workmanship while used in normal service for a period of one (1) year from the date of sale to the original consumer customer. SECO-LARM's obligation is limited to the repair or replacement of any defective part if the unit is returned, transportation prepaid, to SECO-LARM. This Warranty is void if damage is caused by or attributed to acts of God, physical or electrical misuse or abuse, neglect, repair, or alteration, improper or abnormal usage, or faulty installation, or if for any other reason SECO-LARM determines that such equipment is not operating properly as a result of causes other than defects in material and workmanship. The sole obligation of SECO-LARM, and the purchaser's exclusive remedy, shall be limited to replacement or repair only, at SECO-LARM's option. In no event shall SECO-LARM be liable for any special, collateral, incidental, or consequential personal or property damages of any kind to the purchaser or anyone else.

NOTICE: The information and specifications printed in this manual are current at the time of publication. However, the SECO-LARM policy is one of continual development and improvement. For this reason, SECO-LARM reserves the right to change specifications without notice. SECO-LARM is also not responsible for misprints or typographical errors. Copyright © 2014 SECO-LARM U.S.A., Inc. All rights reserved. This material may not be reproduced or copied, in whole or in part, without the written permission of SECO-LARM.

SECO-LARM® U.S.A., Inc.

16842 Millikan Avenue, Irvine, CA 92606
Tel: 800-662-0800 / 949-261-2999 Fax: 949-261-7326

Website: www.seco-larm.com
E-mail: info@seco-larm.com

 PITSW1
MiSA-027HQ_1402.docx
Order Part# 763-180%