

MegaCode Series

MDT, MDT-2, MDT-4 DIGITAL TRANSMITTERS

Installation Instructions

Linear®

(800) 421-1587 • www.linearcorp.com

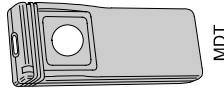

MDT

DESCRIPTION

The MegaCode series of digital transmitters are wireless radio controls designed for use with automatic garage door and gate openers. The MegaCode radio format provides unparalleled security. The system can be programmed to more than a million different codes.

MegaCode transmitters and receivers do not contain a typical "coding switch" as in Linear's standard digital receivers. Each transmitter is pre-set at the factory to a unique code. The receiver is programmed by sending a signal to it from the transmitter(s) that are going to be used with it. This stores the transmitter's code into the receiver's memory. The receiver will retain its memory even without power. The receiver will activate only from these "memorized" transmitters. Please refer to the receiver's instructions for maximum transmitter capability.

The transmitters are powered from two Type 2032 lithium "button cell" batteries. When the batteries get low, the bright red LED light on the transmitter will start to dim as the unit is activated. When the red LED no longer lights when the transmitter is activated, the batteries should be replaced.

MDT - Single-channel transmitter with a button on the front and the top (both buttons perform the same function).

MDT-2 - Three-channel transmitter with two buttons on the front and one button on the top (each button performs a separate function).

MDT-4 - Five-channel transmitter with four buttons on the front and one button on the top (each button performs a separate function).

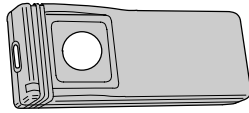

MDT

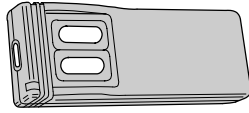

MDT-2

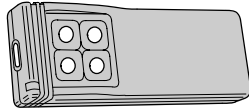

MDT-4

STEP 1 Receiver Installation. Connect the receiver to the garage door operator as described in the receiver's Installation Instructions. Apply power to the operator before programming.

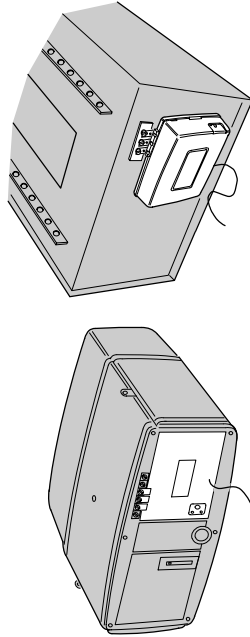

CONNECT RECEIVER TO GARAGE DOOR OPERATOR

STEP 3 Program receiver. Momentarily press the receiver's program button (channel one or two). The red programming LED will light if there's room in the receiver's memory for another transmitter. The LED stays on for about 5 seconds. **A transmitter must be entered while the LED is on.** Press the desired transmitter button. The LED will flicker indicating that the receiver has accepted the transmitter.

➔ **NOTE:** Be sure to press the receiver program button for less than 2 seconds.

➔ **WARNING! Door operator will not activate when the receiver is being programmed from the transmitter, but the door operator will activate the next time the transmitter is activated after programming.**

➔ **NOTE:** The programming LED also monitors radio signals entering the receiver. It is common to see an occasional blink from the LED. The LED will also light when any transmitter tuned to the receiver's frequency (programmed into the receiver or not) is activated.

STEP 2A MDR/MDRR/MDR2 Program button and LED Location. Locate the program button and LED on the side of the receiver case.

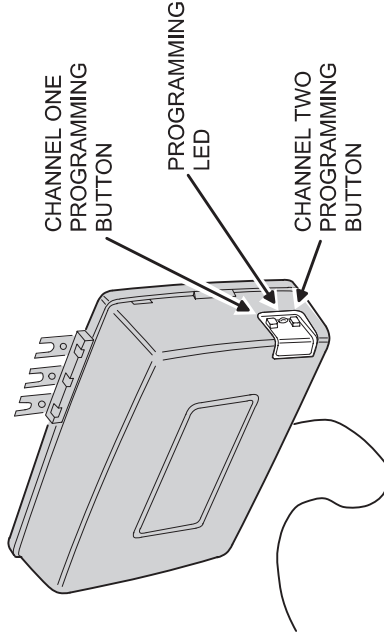

CHANNEL ONE PROGRAMMING BUTTON

PROGRAMMING LED

CHANNEL TWO PROGRAMMING BUTTON

STEP 2B MDRM/MDRM2 Program button and LED Location. Locate the program button and LED on the back of the receiver case.

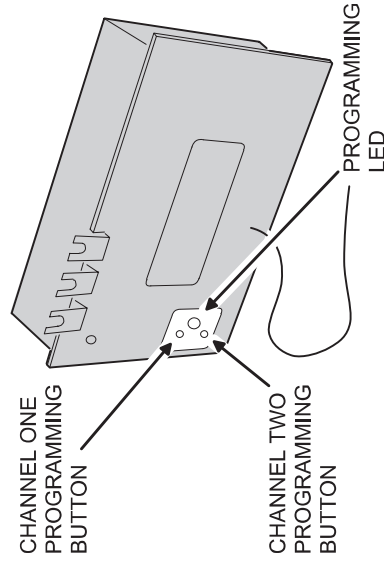

CHANNEL ONE PROGRAMMING BUTTON

CHANNEL TWO PROGRAMMING BUTTON

PROGRAMMING LED

STEP 4 Add additional transmitters. Repeat Step 3 for each transmitter used with the receiver. Be sure to press the receiver's program button **each time a new transmitter or a different transmitter button on a multi-button transmitter is pressed.** If the LED doesn't come on when the receiver's program button is pressed, the receiver's memory is full. Use the erase function (Step 7) to remove transmitters from the receiver's memory.

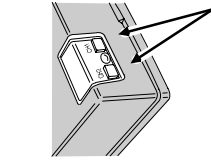

THEN PRESS TRANSMITTER BUTTON

WITH MULTI-BUTTON TRANSMITTERS PRESS THE DESIRED BUTTON

STEP 5 Review memory. Press and hold the receiver's program button (channel one or two) until the LED begins to flash (about 3 seconds) and then release the button. Count the number of flashes. The number of flashes equals the number of transmitters programmed into that channel of the receiver.

➔ **NOTE: Don't hold down the programming button longer than 5 seconds, the receiver's memory for that channel will be erased (Step 7).**

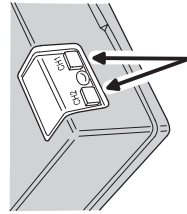

PRESS PROGRAM BUTTON (CHANNEL 1 OR 2) FOR THREE SECONDS THEN RELEASE

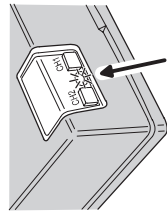

LED WILL FLASH, COUNTING THE TOTAL NUMBER OF TRANSMITTERS PROGRAMED TO THAT CHANNEL

INFO 1A Opening battery compartment. To access the transmitter's batteries remove the battery access screw on the back of the unit. Flip the unit over so that the front is facing you. Use a small screwdriver to open the battery compartment.

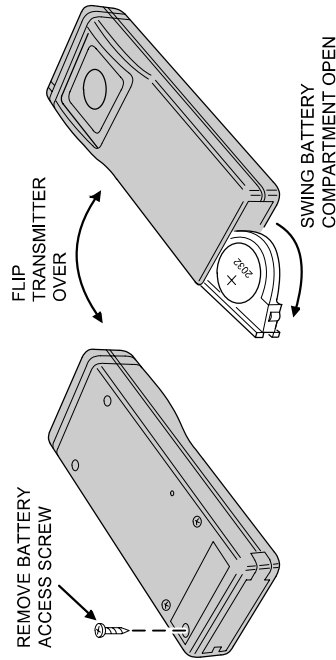

REMOVE BATTERY ACCESS SCREW

FLIP TRANSMITTER OVER

SWING BATTERY COMPARTMENT OPEN

STEP 6 Test receiver. Be sure door area is clear. Activate each transmitter. The receiver relay should click (relay output models only) and the operator should activate. Wait 2 seconds between each activation.

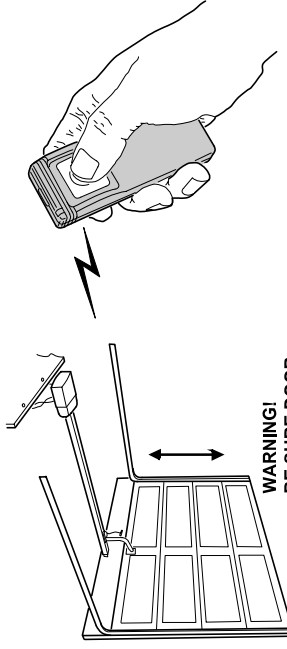

WARNING! BE SURE DOOR AREA IS CLEAR OF OBSTRUCTIONS

PRESS TRANSMITTER BUTTON TO TEST

INFO 1B Replacing transmitter batteries. Replace the two batteries with two Type 2032 lithium batteries or equivalent. The batteries stack on top of each other with the (+) sides facing the front of the transmitter. Replace with new batteries then close the battery compartment, replace battery access screw and test transmitter.

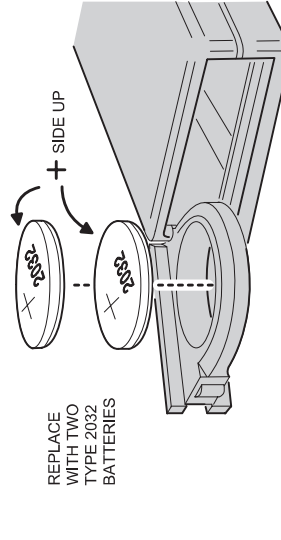

REPLACE WITH TWO TYPE 2032 BATTERIES

+ SIDE UP

STEP 7 Erasing receiver memory. Transmitters may be erased from the receiver's memory by pressing and holding the receiver's program button (channel one or two) for 5 seconds or more. After the LED blinks (count of transmitters) it will blink one more time for channel one and twice for channel 2 as the receiver's memory for that channel is erased. All transmitters for each receiver channel are erased at the same time.

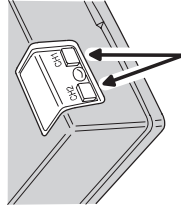

PRESS PROGRAM BUTTON (CHANNEL 1 OR 2) FOR FIVE SECONDS OR MORE

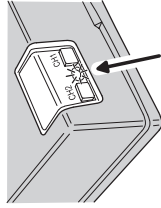

LED WILL FLASH, COUNTING THE TOTAL NUMBER OF TRANSMITTERS PROGRAMED TO THAT CHANNEL. THEN IT WILL BLINK ONE MORE TIME AS THE TRANSMITTERS ARE ERASED FROM THAT CHANNEL

INFO 2 Visor Clip Removal. The visor clip can be removed by removing the three screws as shown. Slide the clip off the retaining plate and reattach the plate to the transmitter.

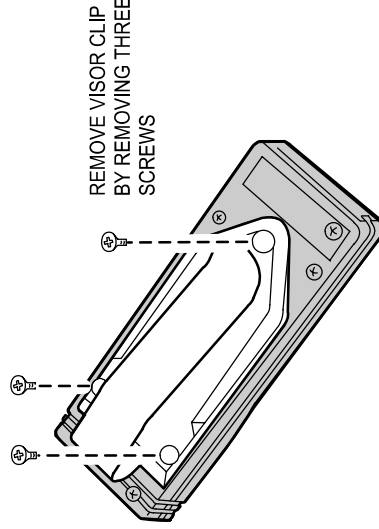

REMOVE VISOR CLIP BY REMOVING THREE SCREWS

➔ **NOTE: The same transmitter (or the same transmitter button on multi-button transmitters) cannot be programmed into both receiver channels 1 and 2.**

➔ **NOTE: If the receiver's LED flashes continuously when a transmitter isn't being activated, the receiver is too close to an electrical noise source. Move the receiver away from the noise source or call technical services for assistance.**

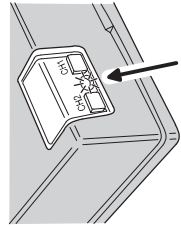

CONTINUOUSLY FLASHING LED MAY

IMPORTANT !!!

Linear radio controls provide a reliable communications link and fill an important need in portable wireless signaling. However, there are some limitations which must be observed.

- * For U.S. installations only: The radios are required to comply with FCC Rules and Regulations as Part 15 devices. As such, they have limited transmitter power and therefore limited range.
- * A receiver cannot respond to more than one transmitted signal at a time and may be blocked by radio signals that occur on or near their operating frequencies, regardless of code settings.
- * Changes or modifications to the device may void FCC compliance.
- * Infrequently used radio links should be tested regularly to protect against undetected interference or fault.
- * A general knowledge of radio and its vagaries should be gained prior to acting as a wholesale distributor or dealer, and these facts should be communicated to the ultimate users.

LIMITED WARRANTY

This product is warranted to the consumer against defects in material and workmanship for one year from the date of purchase. This warranty applies to first retail buyers of new devices. Warrantor will repair, or at its option, replace, any device it finds that requires service under this warranty, and will return the repaired or replaced device to the consumer at the warrantor's cost. For warranty service and shipping instructions contact warrantor at the address shown below. Devices must be sent to warrantor for service at owner's expense. The remedies provided by this warranty are exclusive. Implied warranties under state law are to the one year period of this written warranty. Some states do not allow limitations on how long an implied warranty lasts, so the above limitation may not apply to you. In order to be protected by this warranty, save your proof of purchase and send copy with equipment should repair be required. This warranty gives you specific legal rights, and you may also have other rights which vary from state to state.

All products returned for warranty service require a Return Product Authorization Number (RPA#). Contact Linear Technical Services at 1-800-421-1587 for an RPA# and other important details.