

Dealer Manual

DO NOT GIVE TO HOME OWNER
FOR PROFESSIONAL USE ONLY



Cellular Intercom System



Note: For legal reasons, telephone technical support is for registered and qualified product dealers only. Home owners and end-users should contact their dealer for product technical support.



WARNING

Do not power from the gate controller. Only use the provided UL power supply, otherwise damage may occur and warranty may be void.



Contents

Overview of System	Pg 3
Site Survey	Pg 3
SIM Card	Pg 3
Power	Pg 3
Pedestal Style Call Box Overview	Pg 4
Wall Mount Style Overview	Pg 4
Pedestal Style Mounting	Pg 5
Wall Style Mounting	Pg 5
Inserting the SIM	Pg 5
Connections	Pg 6
Powering Up	Pg 6
Installing the Programming APP	Pg 7
Begin Programming a New Install	Pg 8
Begin Programming Existing Install	Pg 8
Programming	
Check Reception	Pg 9
Programming Dial Out Numbers	Pg 10
Programming Caller ID numbers	Pg 10
Additional Features	Pg 11
1.Volumes	Pg 12
2.Dialling & Talk Times	Pg 12
3.Service Calls	Pg 13
4.Info Screen	Pg 13-14
5.Pass Codes	Pg 15
6.Relay Times	Pg 15
7.Notifications	Pg 16
8.Keypad Programming	Pg 16
Permanent Codes	Pg 17
Time Restricted Codes	Pg 17
Temporary Codes	Pg 18
Delete Codes	Pg 18
9.Automatic Triggering Times	Pg 19
10.Client List on iphone	Pg 19
10b.Client list on Android	Pg 20
11.Clock Sync	Pg 20
11b.Daylight Saving	Pg 21
12.Do Not Disturb	Pg 21
12b.After Hours	Pg 22
Complete List of Parameters	Pg 23
Control by SMS	Pg 25
Troubleshooting	Pg 25

Overview of System

Please read this entire manual before attempting to install this system.

This system should only be installed by a professional automatic gate installer or access control specialist dealer.

It is recommended that the system be set up, configured, commissioned and tested on a workshop bench **before** taken to site for installation.

Site Survey

Before installing this system, you need to be sure that there is good mobile GSM cell coverage in the area it is to be installed. It is recommended that you conduct a site survey, and check reception on the site for a GSM network. If reception is poor in the area, then this system is not recommended. This unit can operate on At&T and T-Mobile networks in the USA.

SIM Card (At&T recommended)

You will need a SIM card in order to use this system. It should be a regular voice and SMS text SIM card. Do not use a data only SIM, as this is only for tablets and will not work in the unit.

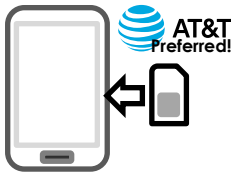

- 1) Ensure the SIM has calling credit, and can make and receive calls on a cell phone.
- 2) Check the SIM is not locked to a phone and had PIN code disabled.
- 3) **This unit will also work on T-Mobile however T-Mobile coverage on compatible frequencies may not be available on all plans in all areas.**

Power

This system comes with a 15v d. C power supply. It is recommended that it is located within 25 feet of the intercom and cabled in **14 gauge cable**, otherwise **damage can occur to the product.**

Site Cabling

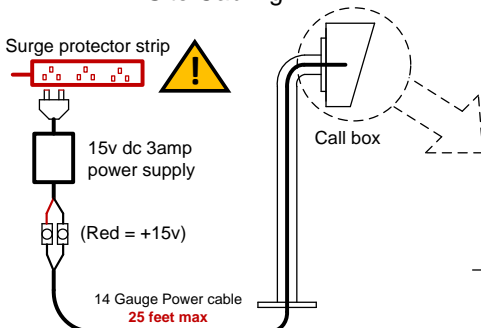

Note: Fit surge protector strip to help prevent surge.

Inside Power Connection

Please note: If using 24v dc solar operator power, switch jumper below to 24v position **BEFORE** turning on power.

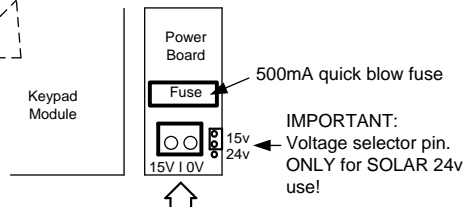

15v DC Power in HERE

Only use power supply provided!



Note: The power board supplies filtered power to the keypad and cellular module, and has surge protection plus a fuse. In the event of a power surge or lightning surge, the fuse is designed to blow and help protect the equipment.

Pedestal Style Call Box Overview



Architectural Wall Mount Style Overview

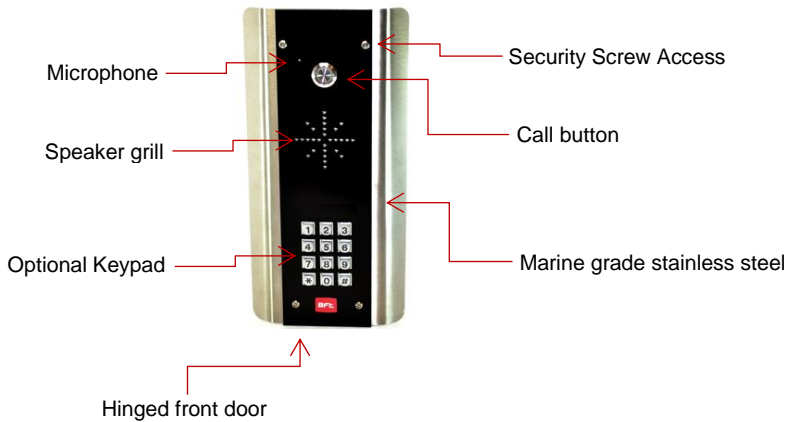

Tip: Keep all protective covers and films on the unit until fully installed. These covers are to protect the unit from scratches during installation.

Pedestal Style Mounting

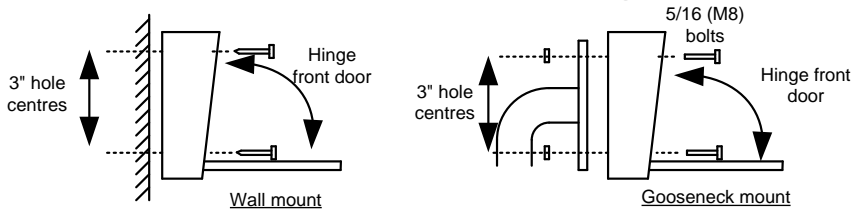

Architectural Style Mounting

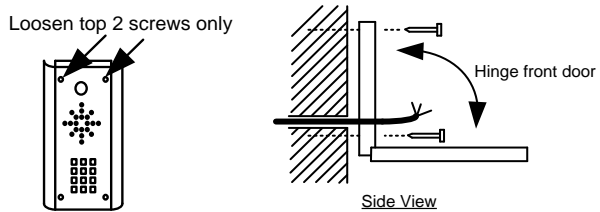

Inserting the SIM card

Note: This unit is a dual 3G/4G system, operating on either 3G or 4G network frequencies.

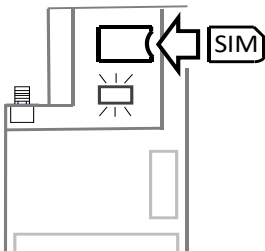

Please ensure the SIM card is a regular voice SIM card with SMS, from either AT&T or T-Mobile. Do not use a data SIM as these are only for tablets.

- 1) Put the SIM into a phone to activate and register it with the network.
- 2) If you are using pay and go, top up the SIM with some airtime credit.
- 3) Test that the SIM can make and receive calls and can send and receive a SMS.
- 4) Ensure the power is OFF.
- 5) Slide the SIM card into the holder (pads down as shown).

Connections on the GSM Controller

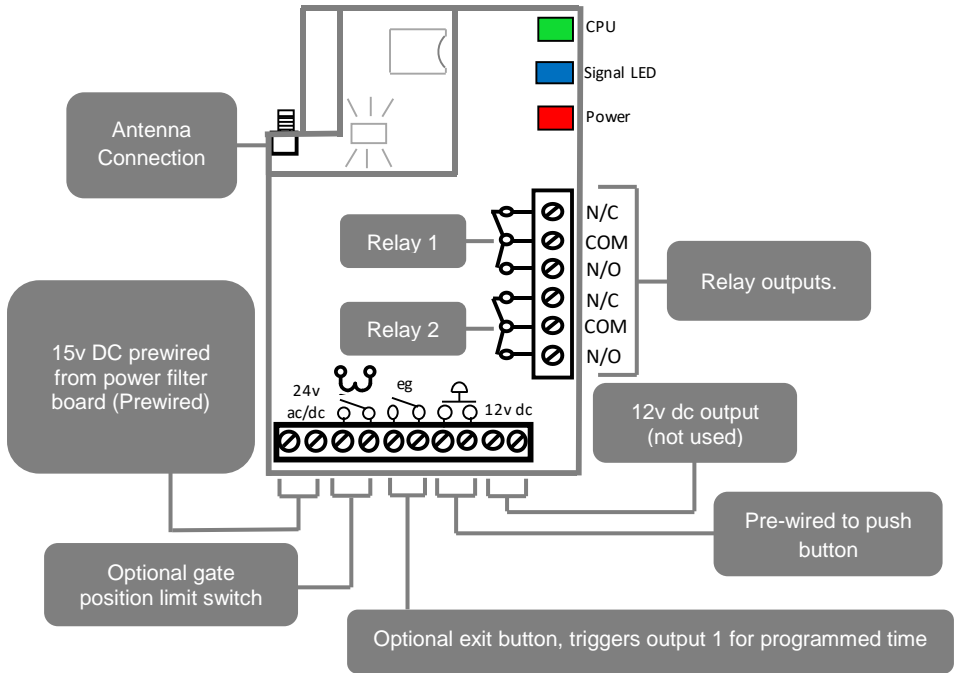

Powering Up

Perform a final check of wiring and ensure the antenna is connected before switching on the power. Once the power is switched on, the power LED should illuminate.

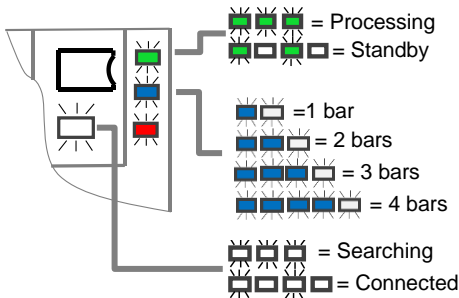

TIPS: My GSM LED is still searching...

- Check the SIM card is registered and can make a call in a phone.
- Check the SIM card is seated correctly. Power off, clean the contacts on the SIM and the GSM unit, and reinsert the SIM.
- Check power cable distance and thickness.
- Increase antenna height.
- Change network.
- Move antenna away from metal objects.
- Fit a high gain antenna.

Installing the Programmer APP for the first time

If you are using an Apple or Android smart phone, download and install the BFT Cellbox **Programmer** app. It will make programming much easier. (You can search store, or scan QR code below)

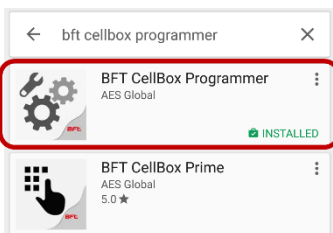

Note: You may notice the app “BFT Cellbox Prime” on the store. This is for the home owner. Installers should install the BFT Cellbox **Programmer** app.

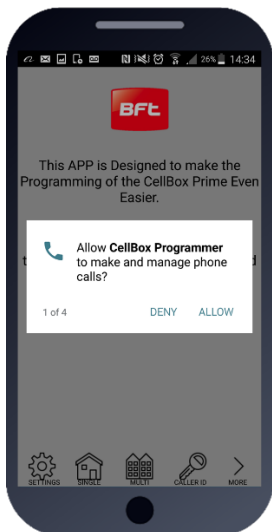

Accept and allow all permissions (Android version shown)

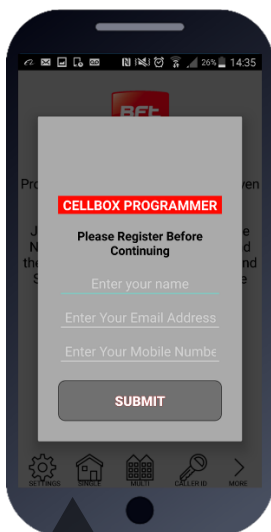

To register first time, enter your name, email and cell phone number.

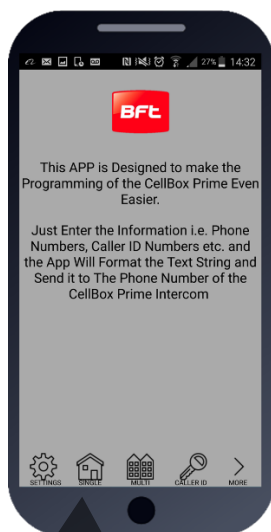

After you send the registration email, go back to the app screen.

Programming a Brand-New Install

Press SETTINGS to reveal the screen shown. This screen will store details for the client.

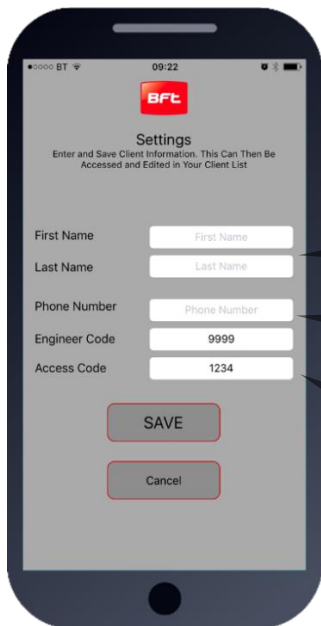

The screenshot shows the BFL Settings screen. At the top, there is a BFL logo and the title "Settings". Below the title, there is a subtitle: "Enter and Save Client Information. This Can Then Be Accessed and Edited in Your Client List". The form contains five input fields: "First Name" (placeholder: First Name), "Last Name" (placeholder: Last Name), "Phone Number" (placeholder: Phone Number), "Engineer Code" (value: 9999), and "Access Code" (value: 1234). At the bottom, there are two buttons: "SAVE" and "Cancel".

Enter name for site or customer.

Enter phone number of INTERCOM.

If Engineers and user pass codes are at default then do not change these..

Now you are ready to begin programming!

Programming an EXISTING Install

1.Go to MORE>CLIENT LIST to reveal the screen shown.

2.Press and HOLD to select the desired client.

3.Iphone users press the info symbol. Android users **press and hold** the client, and then press upload to begin programming.

Now you are ready to begin programming!

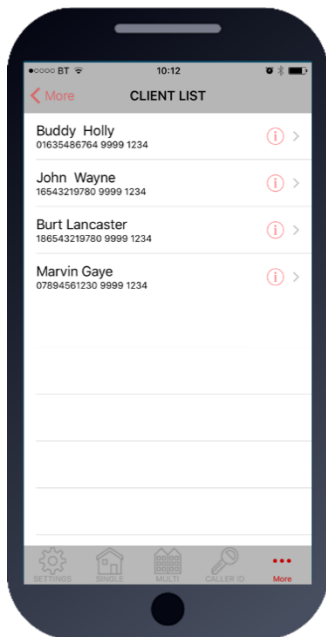

The screenshot shows the BFL CLIENT LIST screen. At the top, there is a "More" button and the title "CLIENT LIST". Below the title, there is a list of clients with their names and phone numbers. Each client entry has an information icon (i) and a right arrow (>). The clients listed are: Buddy Holly (01635486764 9999 1234), John Wayne (16543219780 9999 1234), Burt Lancaster (16543219780 9999 1234), and Marvin Gaye (07894561230 9999 1234). At the bottom, there is a navigation bar with icons for Home, More, and Client List, and a "More" button.

Programming

Now that you have either entered a new client, or selected an existing client from the client list, you are now ready to begin programming.

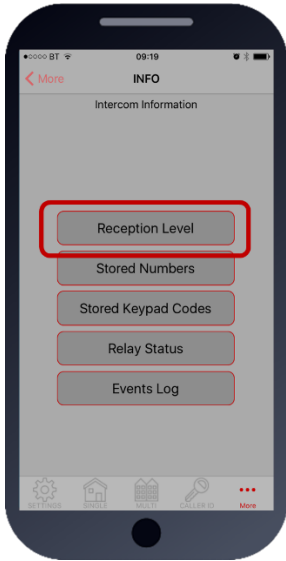

Step 1: Check Reception

Go to MORE>INFO to reveal the screen shown.

Press the reception check button. On Android the app will automatically send a SMS string (*20#) to the intercom.

On iphone, users will be taken to their SMS screen to confirm before sending the string.

The intercom should reply with a signal level between 1 & 31.

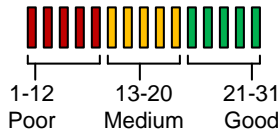

For good performance, signal level on 2G should be at least 13. On 3G it should be no less than 10.

TIP: If signal is lower than recommended, then take IMMEDIATE action. Change network if possible, or use an optional high gain antenna. Check power cable is within recommended specification. (Poor power cable can lower reception).

Note: SMS string= *20#



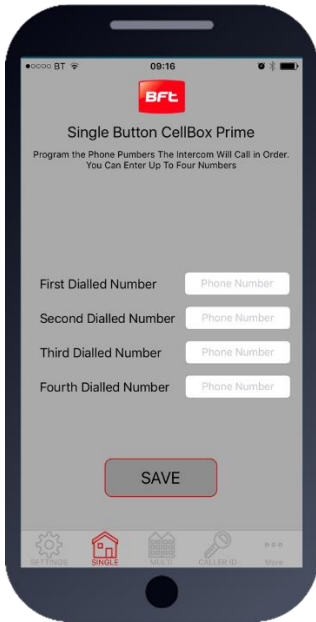

Step2: Programming Numbers for the intercom to call on button press.

1. Press the SINGLE home icon for a 1 button system, or MULTI for a 10 button system.
2. Simply enter cell phone numbers and/or landline phones which the intercom is to call when the call button is pressed. (10 button model please enter button number).
3. Press SAVE. Note: iPhone users will be taken to their SMS screen to confirm the SMS string (press send).
4. The intercom should reply with an SMS to your phone showing the SMS string and an OK status.

SMS Programming Format:

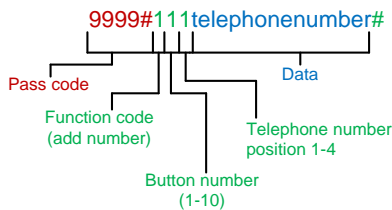

E.g. 9999#111firstnumber#112secondnumber#113thirdnumber#

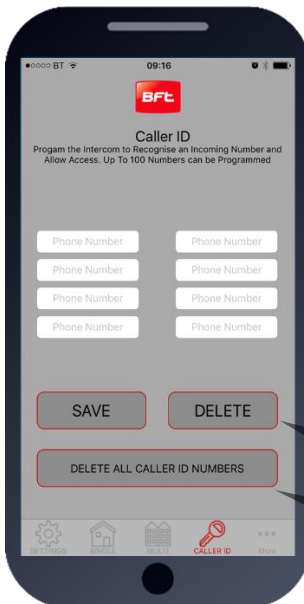

Step3: Programming Caller ID access numbers (100 max).

1. Press the CALLER ID button.
2. Simply enter cell phone numbers of visitors whom should have access with caller ID (up to 8 at a time).
3. Press SAVE. Note: iPhone users will be taken to their SMS screen to confirm the SMS string (press send).
4. The intercom should reply with an SMS to your phone showing the SMS string and an OK status.

SMS Programming Format:

9999#72telephonenumber#72telephonenumber#
72telephonenumber#72telephonenumber#

To delete a number, enter it above and press DELETE.

Delete ALL caller ID numbers and start again.

Programming Additional Features

The intercom should now be able to call users and have some basic Caller ID access. Now you may wish to program additional features for the client, including keypad codes, dialling times (to avoid voicemail on un-answered calls, auto-trigger times etc.



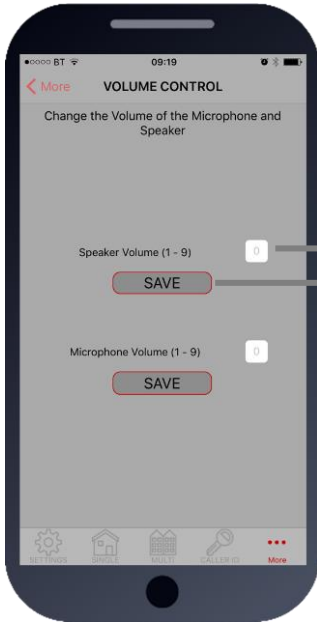

1. Volumes

Adjust speaker and microphone volumes.

Enter required level (1-9) for optimum speech.
 TIP: Set as low as possible for good acoustics.
 Default = 5

Press SAVE.
TIP: Iphone users will be taken to SMS screen to confirm message. Android devices will automatically send the SMS.

SMS string for Speaker Volume:
 9999#3X# (X=1-9, default = 5)

SMS string for Microphone Volume:
 9999#4X# (X=1-9, default = 5)

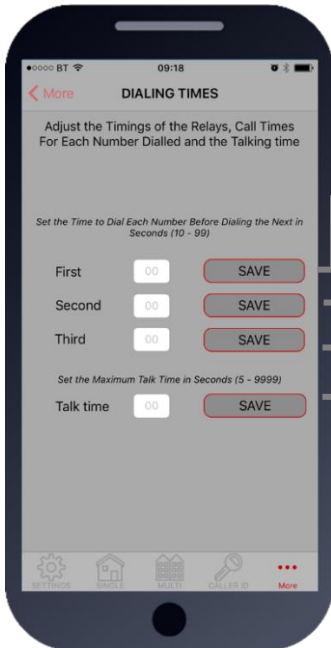

2. Dialling Times & Talk Time

Change ringing times on each number to avoid voicemail picking up a call on un-answered call so the unit can roll over to the next number.

Note: Default 20 secs (includes 5-8 sec connection time).

Dialling time for first number (default 20 secs)

Dialling time for second number (default 20 secs)

Dialling time for third number (default 20 secs)

Set MAX talking time for all numbers (default 60 secs)

TIP: Iphone users will be taken to SMS screen to confirm message. Android devices will auto send the SMS.

SMS strings:

- 9999#45XX# (X=dialling time for first number)
- 9999#46XX# (X=dialling time for second number)
- 9999#47XX# (X=dialling time for third number)
- 9999#53XXXX# (X= talking time in seconds, 9999 max)

3. Service Calls

This feature is normally only used on intercoms which are seldom used and only for SIM cards which are likely to be de-activated by the network due to inactivity. It can be programmed to make a chargeable outgoing call or SMS to a number of your choice using this screen.

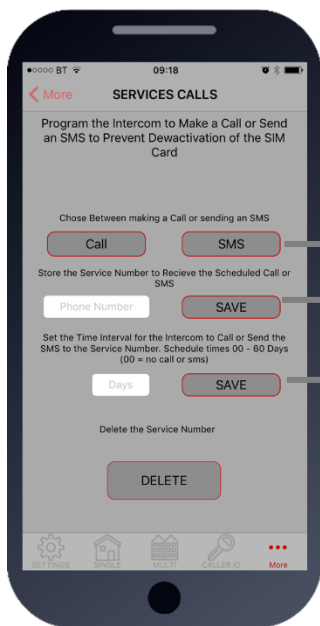

Choose SMS or CALL

Enter the phone number which is to receive the call

Enter the frequency of calls (1-60 days).

TIP: This will call or SMS at the time at which the feature was activated. So, if you set this feature up at 5pm, it will make the service call or SMS at 5pm at the next interval.

SMS string for choosing SMS or CALL:

9999#58X# (For calls, X=2, for SMS, X=1)

SMS string for entering phone number:

9999#77XXXXXX# (X=cell phone number) 77*# to delete.

SMS string for frequency of calls:

9999#57XX#

4. Info

TIP: Iphone users will be taken to SMS screen to confirm message. Android devices will auto send the SMS.

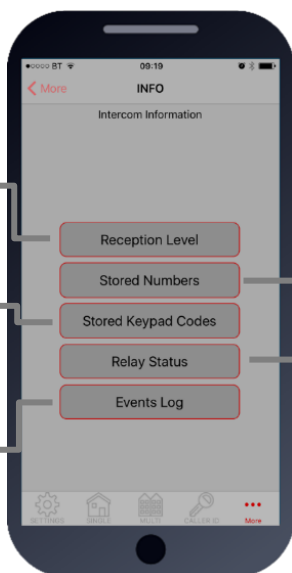

Check signal strength

Check stored keypad codes

Check who opened the gate, when it was opened and by what method

Check stored phone numbers

Check relay status

***20#**

Signal=18 3G

SIGNAL STRENGTH

Will reply with signal range 1-31 Should be higher than 10.

***21#**

O11:987654321
O12:123456789
I1:987654321
I2:123456789
I3:5559991234
I4:9995559876

STORED NUMBERS

O=Dial out number.
I=Dial IN Caller ID number.

STORED CODES

NORM=Permanent codes.
TEMP=Temporary codes.
PLAN=Time restricted codes.

1234#25#

Norm: 1234,
5555,6565,4321
Temp:
4545,7878,9876
Plan: 1010,4343

RELAY STATUS

OPEN – Shows status of the input terminals called STATUS on the intercom, can be used with a limit switch. Relay status shown to check if any relay is latched.

***22#**

Open
Relay1=OFF
Relay2=OFF

***23#**

0930-05/06/17-code-XX34
2108-04/06/17-CID-543210
2034-04/06/17-user-55987
1632-04/06/17-codeXX89

1244-04/06/17-code-XX98
0840-04/06/17-cid-995555
2109-03/06/17-code-XX34
2101-03/06/17-codeXX89

ACTIVITY LOG

Use this to see who used the intercom and when. Which pin codes were used, who used caller ID, who answered the call.

TIP: Time and date is in international military format.

Last 5 digits of caller ID user phone number

Last 5 digits of phone number which answered the gate

Last 2 digits of keypad code used

5. Pass Codes



CAUTION: Take care when changing pass codes. There are 2 levels of 4-digit code (both must be different):

1. Engineers/Programmers code (default 9999)
2. Access/user code (default 1234)

You may wish to change both from their defaults for security.

Restore the app to using default codes (does not restore the intercom)

Enter new programmers code (default 9999)

Enter new user/access code (default 1234)

If changing default codes, then you will now need to update the client list before you can do any further programming. **If the 1234 user access code is changed, then you will also need to change it on the home owners app.**

SMS Strings:

9999#01XXXX# (X=new programmers code)

9999#02XXXX# (X=new user access code)



6. Relay Times

Relay default trigger times are 1 second. Use this feature to change a relay for a longer time perhaps for a magnetic door lock or to make one relay a momentary relay and the other a 1 hour relay for example.

Enter time in SECONDS then press SAVE to send SMS

TIP: Iphone users will be taken to SMS screen to confirm message. Android devices will auto send the SMS.

SMS string for relay 1:

9999#50XXXX# (X=time in seconds, 1-9999)

SMS string for relay 2:

9999#51XXXX# (X=time in seconds, 1-9999)

7. Notifications

This feature is commonly used to allow one home user to receive SMS alerts each time the INTERCOM is used to trigger the gates and grant access.

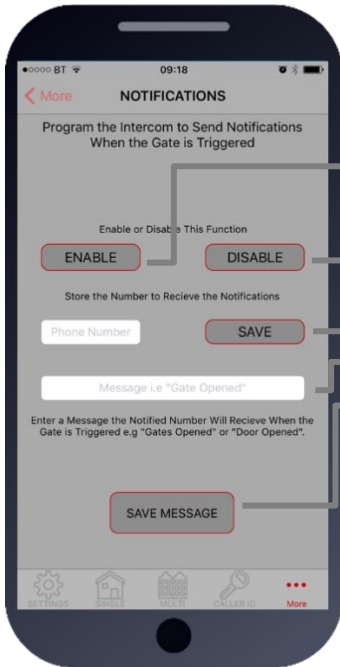

Quick Enable / disable this feature

Enter the phone number to receive the SMS alert and press SAVE

Enter text which you want the user to receive when access is granted, then press SAVE MESSAGE

SMS string for turning ON or OFF:

9999#80X# (X=2 to enable. X=1 to disable)

SMS string for entering phone number to receive notification:

9999#78XXXXXXXX# (X=cell phone number) 78*# to delete.

SMS string for entering text to display:

9999#79XXXXXXXX# (X is any text message you wish to display on the phone. E.g. Gates Opened)

8. Keypad Programming



For Permanent 24/7 Codes

For temporary codes (codes which auto-expire in a pre-set time)

For Time Restricted Codes (codes that work during certain times & days of the week)

For deleting codes

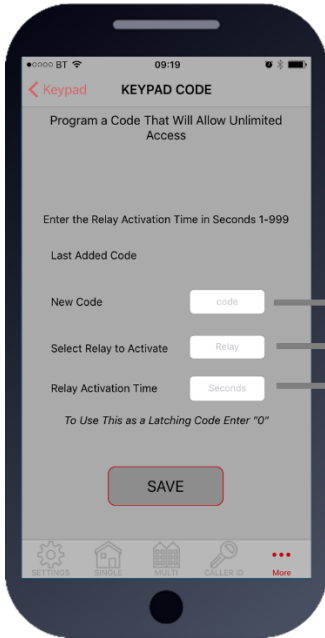

Permanent Keypad Code

Stores up to 200 codes, all of which can be used to gain access 24/7.

Enter 4 digit code

Choose Relay 1 or Relay 2

Enter activation time. (0-9999 seconds)
 Use 1 second for gate trigger.
 Use approx. 5 secs for magnetic locks.
 Use 0 for latching or toggle code.
 Use 3600 secs for 1 hour hold open on gates

SMS String for adding keypad codes:

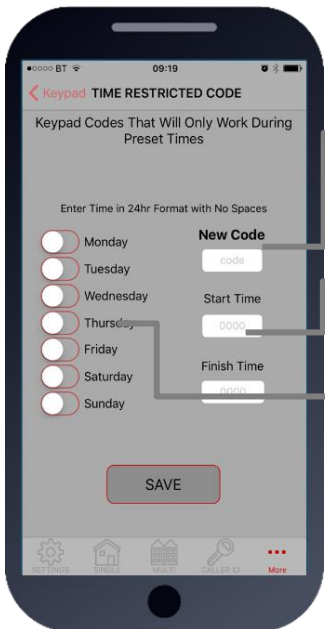
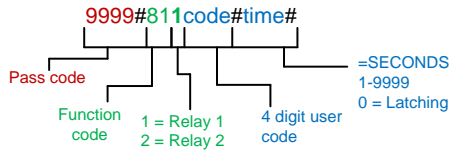

Time (Restricted) Code

Stores up to 20 codes which will only work during pre-set times and days of the week. (Relay 1 only).

Enter 4 digit code

Enter Start and Finish time
 (Military format without any colons.
 E.g. 8am = 0800. 11pm = 2300)

Select days of the week the code is to be active.

SMS String for time restricted code:

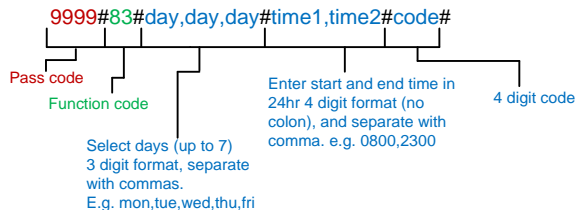

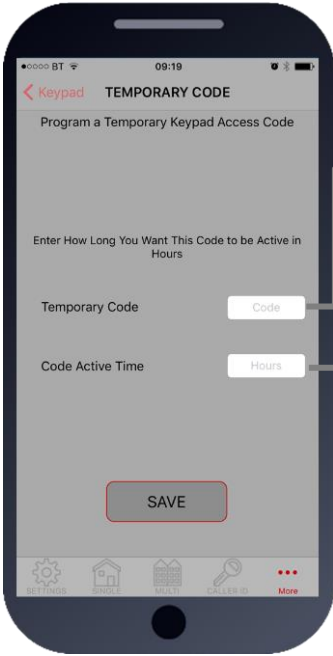

Temporary Code

Stores up to 30 codes at any time which will auto expire after a pre-set countdown time (1-168 hours) (Relay 1 only)

Enter 4 digit code

Enter countdown time in hours (1-168 hrs)

SMS String for temporary code:

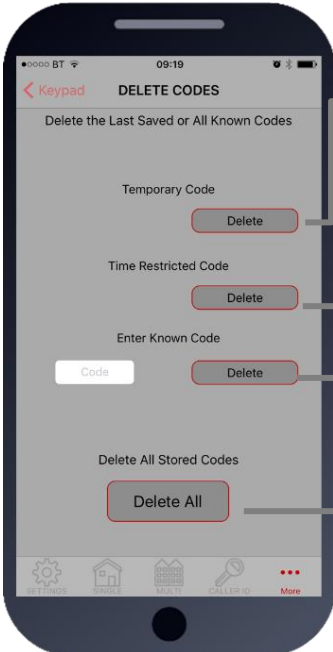
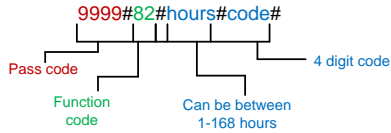

Delete Codes

You can use these buttons to delete a recently stored temp or time restricted code (codes shown beside the delete button)

Delete any known code

Delete ALL codes

SMS String for deleting a known code:

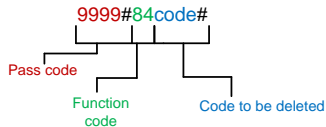

Deleting ALL codes: 9999#84*#

9. Auto Relay Trigger Times

Create up to 40 automatic time clock events to trigger or latch/unlatch gates (depending on gate system setup). For auto closing gates, send latch command at the desired opening time, followed by a separate unlatch event to close at the desired closing time.

For step-by-step operated gates (non auto-closing), then send a momentary trigger command at the time required to change the state of the gates from open to closed or closed to open.

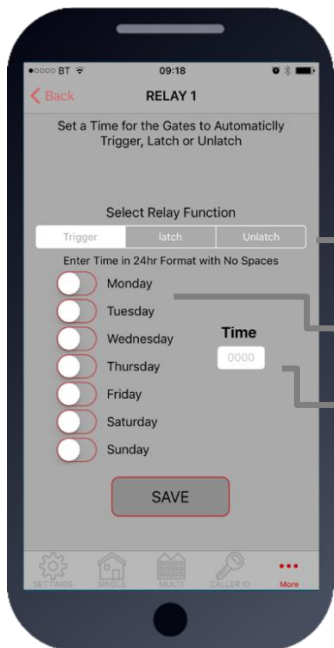

1. Pick the type of event (momentary/latch/unlatch)

2. Choose the days

3. Enter the time in military 24hr format without colon
E.g. 8.30am = 0830. 11:10pm = 2310.

1234#1#day,day,day#time#

USER passcode Enter time in 24hr format (no colon)

Command:
1=trigger relay 1
2=latch relay 1
3=unlatch relay 1
4=trigger relay 2
5=latch relay 2
6=unlatch relay 2

Select days (up to 7)
3 digit format, separate with commas.
E.g. mon,tue,wed,thu,fr

10. Client list on iphone

The client list allows you to save sim phone number, customer name and pass codes for all your installs.

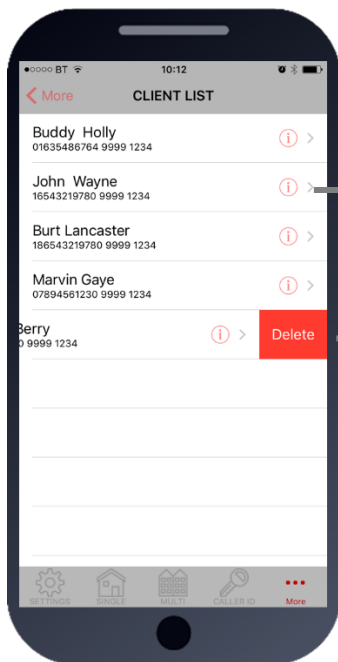

Press to select Client

Swipe to delete

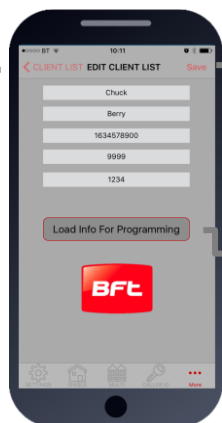

Press to SAVE after editing

Press to load details & program

On any previous install, you can load the customer and then re-program their intercom.

10. Client list on android

The client list allows you to save sim phone number, customer name and pass codes for all your installs.

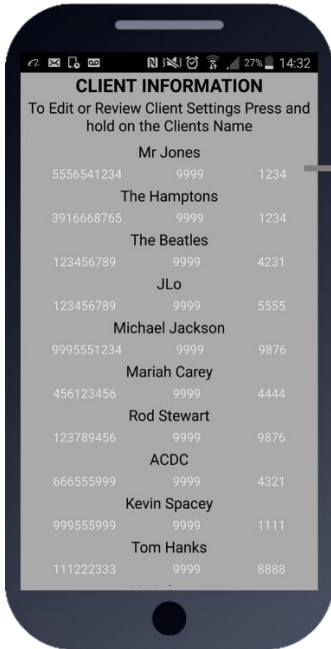

Press & HOLD to select Client

Press to load details & begin programming

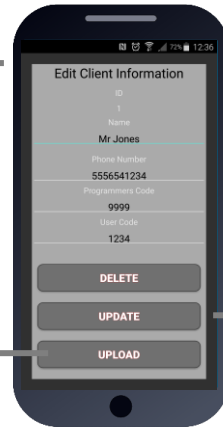

Press to save changes

On any previous install, you can load the customer and then re-program their intercom.

11. Clock Sync

The unit has an internal time clock counter, which reads the time from an incoming SMS message, and uses this to calibrate its time clock.

For power failure events, this feature allows the unit to send a SMS to itself after a power failure.

Simply press the button and the app will send a SMS string to the intercom storing the phone number from the SIM card inside memory.

TIP: Use this if your area experiences regular power cuts and your client is using timed features.

Note: Using this feature will cause the unit to be busy for 2-3 minutes after a reboot. Please be patient with programming etc after a re-boot.

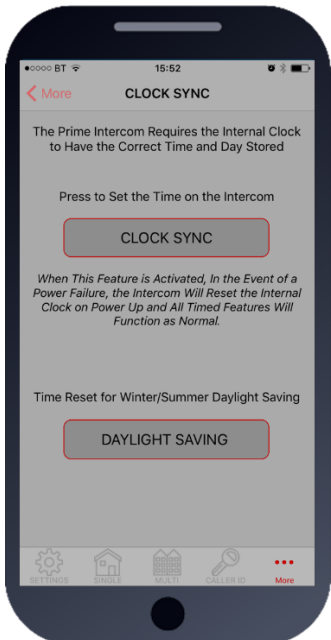

TIP: 9999#86*# will delete this number again

11b. Daylight Saving

For regions where there is a 1 hour time shift for daylight saving, it can be useful to have the intercom send itself a SMS every set number of days to re-synchronise the internal clock. The intercom will do this anyway each time a SMS is received.

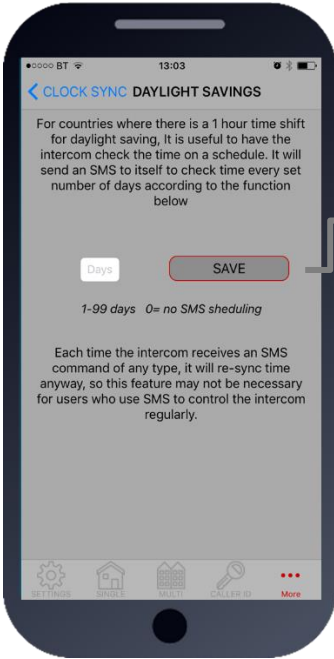

Set the number of days between SMS message sending (depending on carrier provider, this may be chargeable to the customer).

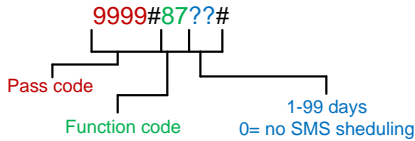

12. Do not disturb

This feature allows the push button on the intercom to be active during pre-set times, and ignore button presses all other times.

Use this screen to set the **ACTIVE** times and days for the button.



Quick enable/disable button

Select start and finish times for the button to work (24hr format, no spaces or colon. E.g. 8:30am = 0830)

Press save to send SMS command.

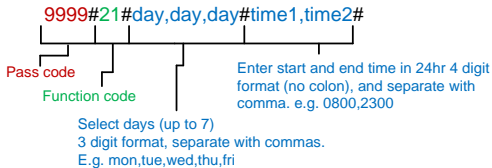

To activate, enter the following code:

1234#21#ON# (change ON to OFF to disable again).

12b. After Hours / Out of Hours

If you have activated the do not disturb feature, the push button will not call anyone after the pre-set time threshold. However, sometimes it is useful to have the intercom call a different number after hours. For example, in commercial premises it can call the office phones during business hours, and then call a security guard after hours.

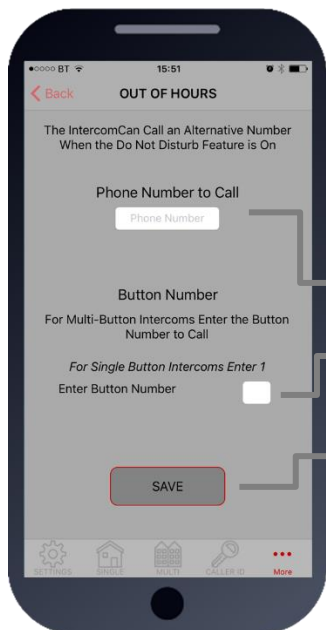

1. Enter phone number to call after hours.

2. Enter button number (enter 1 for single button system)

3. Press SAVE to confirm and send SMS

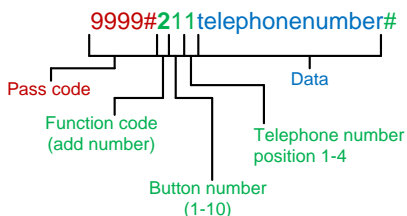

Complete list of parameters

The table below show the complete list of features. **Programming messages below must begin with 9999# (assuming 9999 is still the programming passcode)...**

Changing pass codes

9999#01????#	Change programming password	9999
9999#02????#	Change access control password (SMS control of relays, or non-stored numbers can call intercom & enter code to activate output 1).	1234
9999#03????#	Change monitoring mode password (user can call the intercom, enter this pass code to listen in and speak)	5555

Dial out numbers

9999#1XY????#	Store dialling out numbers. (X = button number 1-9 & 0 for button 10) (Y = number dialled 1-4) (???? = phone number)	N/A
9999#1XY*#	Delete a dial out number. (X = button number) (Y = number position 1-4)	N/A

Volume controls

9999#3?#	Speaker volume. Where ? = 1-9. 1 = lowest, 9 = highest.	5
9999#4?#	Microphone volume. Where ? = 1-9. 1 = lowest, 9 = highest.	5

Timings

9999#50?#	Relay 1 time. ? = seconds, 1-9999	1 sec
9999#51?#	Relay 2 time. ? = seconds, 1-9999.	1 sec
9999#45??#	Calling time for first number, adjust this to avoid voicemail picking up a call (10-99 secs)	20 secs
9999#46??#	Calling time for second number, adjust this to avoid voicemail picking up a call (10-99 secs)	20 secs
9999#47??#	Calling time for third number, adjust this to avoid voicemail picking up a call (10-99 secs)	20 secs
9999#53????#	Talking time. 5-9999 seconds.	60 secs
9999#55??#	Max monitoring time (for listen in mode when calling the intercom) 00-60 mins. 00 = no limit.	10 mins

Scheduled service calls

9999# 77number#	Store a service number to receive a scheduled call or SMS from the unit. Useful for SIM cards which are not often used to prevent switch off by the network provider.	N/A
9999#57??#	Set the time schedule for the intercom to make a scheduled call or SMS to the service number. 00-60 day time schedule. 00 = no call or SMS.	00
9999#58?#	Choose between making a scheduled call or scheduled SMS. 1 = SMS. 2 = call.	1
9999#77*#	Delete the stored service number	N/A

Caller ID features

9999# 72number#	Store caller ID number. Max 14 digits. Only last 6 digits compared.	N/A
9999# 73number#	Delete caller ID number.	N/A

9999#73*#	Delete all caller ID numbers	N/A
-----------	------------------------------	-----

Service & diagnostic messages (no passcode required for some of these!)

*20#	Check reception level 1-31 (no passcode needed)	N/A
*21#	Check stored numbers. O = dial out number. I = dial in number. E = end of message. (no passcode needed)	N/A
*22#	Check input status and relay status. (No passcode needed)	N/A
*23#	Sends SMS messages of the last 20 events.	N/A
1234#25#	Check stored keypad codes.	N/A

Keypad Programming

9999# 81Xcode#time#	Permanent codes - X=1 or 2 for relay 1 or 2. Code = 4-6 digits. Time = 1-9999 seconds, or 0 for latching code.	N/A
9999# 83#day,day,day #time1,time2# code#	Time restricted codes Day = day of the week e.g. mon,tue,wed,thur,fri. Time1 = start time. Time2 = end time (24 hr format, no colon. E.g. 11:30pm = 2330. 8.30am = 0830. Code = pin code 4-6 digits.	N/A
9999# 82#hours# code#	Temporary codes Hours = time to expire in hours (1-168 hours). Code = Pin code 4-6 digit code.	N/A
9999#84code#	Delete code – Code=known code to be deleted.	N/A
9999#84*#	Delete all codes.	N/A

Notifications

9999#80X#	X=1 to disable. X=2 to enable.	N/A
9999#78XXX#	X=phone number to send notifications to. (*=delete number)	N/A
9999#79text#	X=text to send to the receiving phone e.g. "gate opened"	N/A

Automatic Time Clock Trigger Times

1234#X# day,day,day# time#	X=1,2,3 (trigger, latch, unlatch relay 1) 4,5,6 (relay 2) Day = days of the week (mon,tue,wed,thur,fri,sat,sun) Time = time of day (24 hr format, no colon. E.g. 8:30am = 0830)	N/A
1234*X#	Delete ALL automatic trigger times.	N/A

Clock Sync - Auto Time Calibration after Power Fail

9999#86XXX#	X=telephone number of SIM inside the intercom.	N/A
9999#86*#	Delete the phone number.	N/A

Summer Daylight Auto Correct

9999#87??#	?? = number of days between SMS calibration SMS should be sent. 0 = no message sending.	N/A
------------	---	-----

Do Not Disturb (push button de-activated during set times)

1234#21#ON#	ON = activated. OFF = de-activated.	OFF
9999# 21#day,day,day #time1,time2#	Enter all active days during which button should operate. Enter start and end time button should operate (24 hr format, no colon. E.G 8:30am = 0830)	N/A

Alternate Number to Call During Do Not Disturb Times.

9999# 21X????#	X = button number (1-9. Enter 1 for 1 button system. Enter 0 for button 10) ???? = Alternative phone number to call out of hours.	
-------------------	--	--

Restore Defaults

9999#999#	Send with passcode string to clear all programming.	N/A
-----------	---	-----

Control by SMS

This intercom allows the user to send SMS commands to control the relays and check status as follows...

1234#1# - Relay 1 momentary trigger.

1234#2# - Relay 1 latch ON or hold ON.

1234#3# - Relay 1 unlatch or switch OFF.

1234#4# - Relay 2 momentary trigger.

1234#5# - Relay 2 latch ON or hold ON.

1234#6# - Relay 2 unlatch or switch OFF.

Troubleshooting guide

Q. The unit will not power up. No LEDs on.

A. Check power supply voltage at intercom is within 14.8V DC. Cable length from PSU to intercom should be less than 25 feet and in 14 gauge. Check the fuse.

Q. The unit powers up but is not showing network reception or will not respond to SMS.

A. This means the unit is not able to detect the network for some reason.

-Power off the unit, remove the SIM and check it in a mobile phone to verify it can make a call and has calling credit.

-Disable any PIN code request if active on the SIM card.

-Check the SIM is a standard voice capable SIM. If you are unsure, contact your SIM card provider to verify. Compatible networks are At&T and T-Mobile.

-Check the reception is medium or good. Poor reception is not sufficient.

-Power off, remove the SIM, use fine sand paper to lightly sand the SIM pads and contacts on the GSM unit, lightly bend the contacts upwards so that they make better contact with the SIM and try again.

Q. The unit calls the first number, but there is not enough time to answer before it diverts to the next number.

A. Increase the no answer time as per programming instructions.

Q. The unit calls the first number but voicemail comes on before it can ring the second number.

A. Decrease the no answer time as per programming instructions.

Q. The caller ID part does not work.

A. Be sure to program the caller ID part under 72 feature. If your number is a private or number withheld, then it will not work.

-Even if you have already programmed a number to receive a call from the intercom, if you also want that number to have caller ID access, it must be programmed under the 72 feature also.

- Ensure the number is entered as you would normally dial it from another phone.
- For US customers, ensure the numbers have been entered with a leading 1. If this does not work, try again without the leading 1.

Q. There is no audio from the gate, but the person at the gate can hear ok.

A. This can be due to low reception or excessively long power cables.

- Check reception level by *20#.
- Change SIM card if necessary to another network which may have better coverage.
- Purchase a high gain antenna.

This may also be caused by a defective microphone, water on a microphone from a sprinkler for example, or dirt/insects blocking the microphone hole. If reception is optimum and the problem persists, contact your supplier or installer.

Q. The audio quality that can be heard on the remote telephone is poor or humming (buzzing).

A. A small amount of GSM buzz can be considered normal on GSM intercoms, but not so much that causes inability to hear the person speaking. This is a symptom of poor reception. Try above steps on checking and improving reception. Consider fitting an external high gain antenna.

Q. The trigger keys do not work when the intercom calls a phone.

A. Check if you can hear the relay clicking at the gate when the keys are pressed during a call. If it can be heard, then the system is working, check wiring between the relay and the lock or gate panel. If the relays do not make a clicking sound, then check this feature on a different mobile cell phone or landline. If it works on a different phone, check the settings on the phone in question under DTMF tones.

Failure of DTMF tones to operate correctly is also a symptom of low reception or insufficient power cabling. Check steps above on improving reception or addressing the power problem.

- Also check that the relays are not already latched with the *22# command. If they are latched, they need unlatched before the trigger keys will work.
- Sometimes excessively long power cables or thin power cables can cause this problem. Prove it by connecting a temporary extension lead and the power supply directly to the unit.

Q. The system was operating the gates fine, but now it will not trigger the gates.

99% of the time, this is caused by the user accidentally latching the relay. This latches the output relay permanently on. Send the intercom the following SMS *22#. The intercom should reply with a message detailing the relay status.. If it has been latched, then the message will state "the relay is ON". In this case refer to the user guide to read how to unlatch it again.

Q. The unit no longer calls out to phones but I can make a call to it from my phone.

A – Check there is balance on the SIM card.

A – Switch off the power, remove the SIM, put it into a phone, and check that a call can be made from a phone. This will verify if the SIM is still working and in service.

Q. The Android App shows an error message “Command Failed” when I try to use a function.

A – Go to phone settings/application manager/cellbox prime/permissions, and ensure all permissions are turned ON. Also ensure the app settings screen has a valid phone number stored.

Change History

Key:

P = Panel version H = Hardware PCB version S = Software version

Version			Reason for change	Date
P	H	S		

Warranty Terms

Please note, by installing this product, you are accepting the following warranty terms:

1. The manufacturer's warranty is a "return to base" 3 year warranty from date of manufacture. This means that any suspected defective components or items are returned to the manufacturer's agent (BFT Americas Inc) for investigation and diagnosis, and returned at the cost of the customer.
2. The warranty does not cover, nor is the manufacturer or agent responsible for any of the following whatsoever: Storm damage, lightning or surge damage, flooding, accidental damage, vandalism or deliberate damage, un-explained corrosion or unusually harsh environments, failure of telephone networks, future un-interoperability between the product and network providers which cause mal-function due to changes implemented by the phone providers after manufacture of the product, or that which is outside of control of the manufacturer (e.g. 2G, 3G switch off), and damage due to not proper installation.
3. The manufacture in no way accepts liability for any of the following incurred due to a product defect: Cost of attending site, inconveniences, labour rates, time lost, loss to or damage to property, security breaches, late payment clauses or breaches of any contracts between the installer and the client.
4. This is a profession install product only. The product is a component of an overall system. Therefore, it is the responsibility of the installer to certify the safety and compliance of the overall finished system. As soon as this product is fixed to another item, or connected to another third-party device, then the product has been modified, and compliance with local regulations in the country of install is strictly the responsibility of the installer.
5. Re-stocking fees may apply to items returned that are found to be non-defective. Complete units will also attract a re-stocking fee if returned for credit, regardless if a defect is discovered or not. Re-stocking fees may vary depending on the condition of the item being returned, and whether it can be determined as in brand new condition. The warranty terms do not entitle customers to an automatic full refund. For more details on returns procedures and re-stocking fees, contact the agent.

BFT Americas

6100 Broken Sound Parkway N.W. Suite 14, Boca Raton, FL 33487



www.bft-usa.com

Note: For legal reasons, telephone technical support is for registered and qualified product dealers only. Home owners and end users should contact their local dealer for product technical support.

Toll Free: 877-995-8155 Office: 561-995-8155