

# Installation/Owner's Manual

# Model 1812 Classic

## Residential Telephone Intercom/Access Control System

Use this manual for circuit board 1871-010 Revision S or higher.

1812-065-W-10-15

Control a main door and gate.

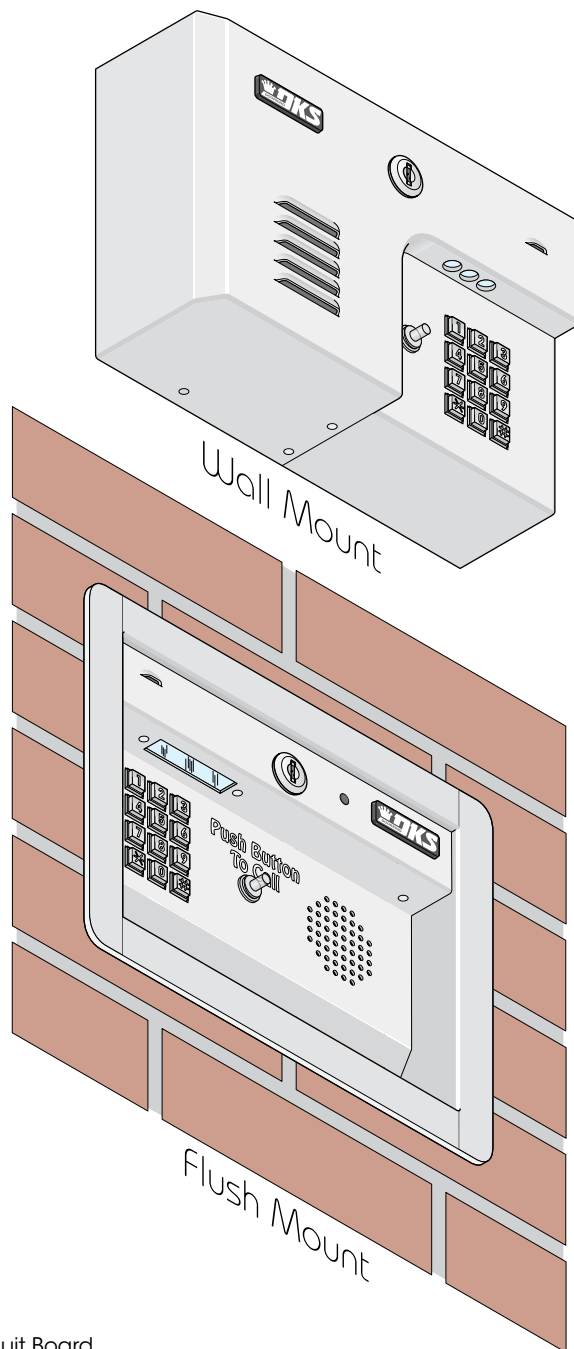
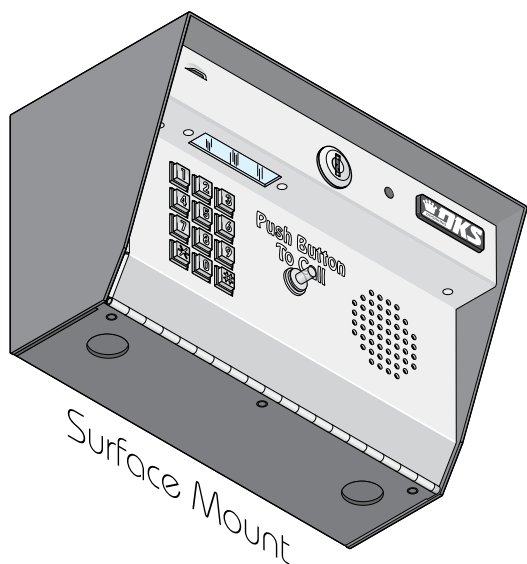

Date Installed: \_\_\_\_\_

Installer/Company Name: \_\_\_\_\_

\_\_\_\_\_

Phone Number: \_\_\_\_\_

Circuit Board  
Serial Number  
and Revision Letter: \_\_\_\_\_

**Leave Manual with Owner**

Copyright 2015 DoorKing, Inc. All rights reserved.





# SPECIFICATIONS

For Model 1812 Classic with circuit board 1871-010 Rev S or higher ONLY.

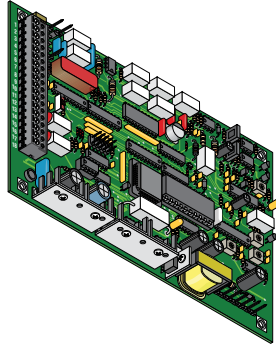

## Features

- Unique telephone communication system allows homeowners to use their telephone as an intercom to speak to a guest at a front door or gate, and to control access to their property.
- Unit connects directly to the homeowners existing telephone line. No additional monthly expense for a second telephone line.
- Built in call waiting assures that incoming calls or guest calls are not missed.
- Two internal relays allow the system to control a main entry gate plus a pedestrian access gate.
- Built-in clock / calendar provides the following time related functions:
  1. Do-not-disturb time zone.
  2. Four hold-open time zones.
  3. Access code time zone.
  4. Call forward time zone.
  5. Flash access code.
- Unit can be programmed to work with PBX and KSU phone systems.
- Optional secondary keypad can be added for remote access code activation of door or gate.

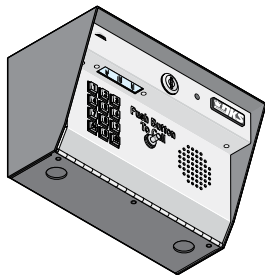

**Surface Mount**

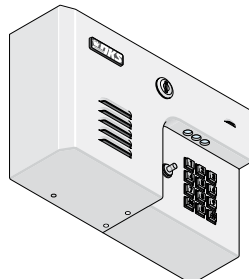

**Wall Mount**

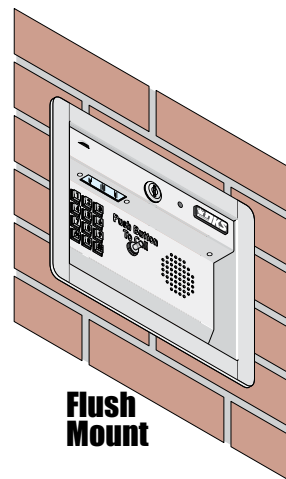

**Flush Mount**

DoorKing, Inc. reserves the right to make changes in the products described in this manual without notice and without obligation of DoorKing, Inc. to notify any persons of any such revisions or changes. Additionally, DoorKing, Inc. makes no representations or warranties with respect to this manual. This manual is copyrighted, all rights reserved. No portion of this manual may be copied, reproduced, translated, or reduced to any electronic medium without prior written consent from DoorKing, Inc.

# SPECIFICATIONS

## Surface Mount Dimensions

**Front View**

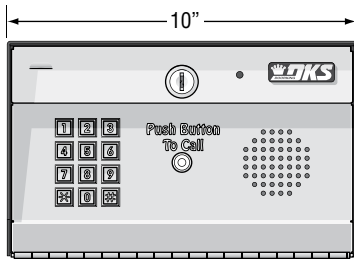

**Side View**

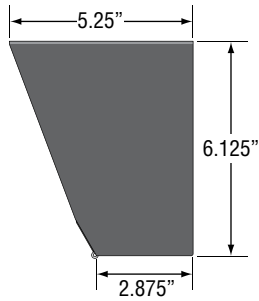

**Back View**

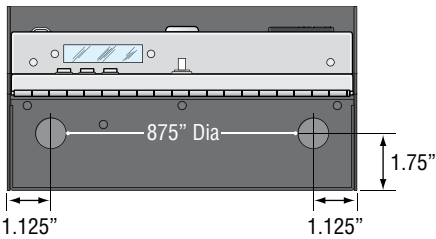
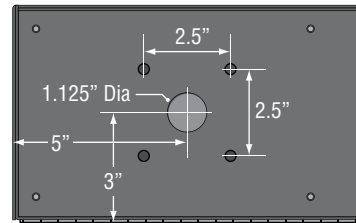

**Bottom View**

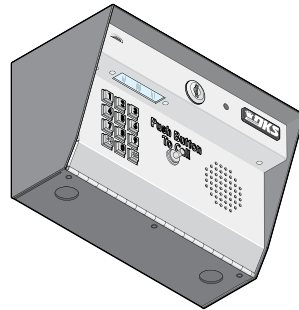

## Wall Mount Dimensions

**Front View**

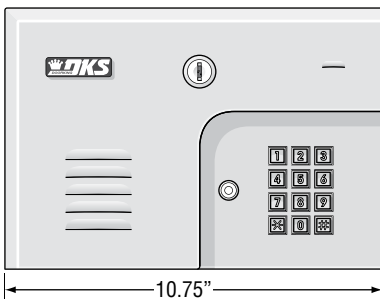

**Side View**

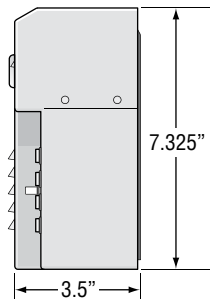

**Back View**

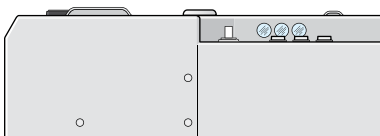
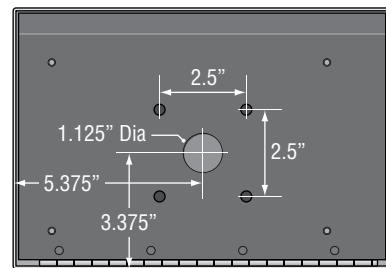

**Bottom View**

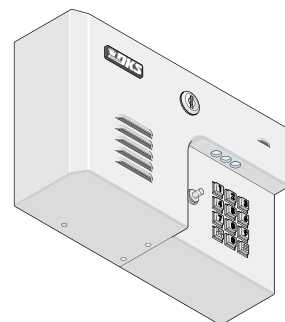

# SPECIFICATIONS

## Flush Mount Dimensions

### Side Views

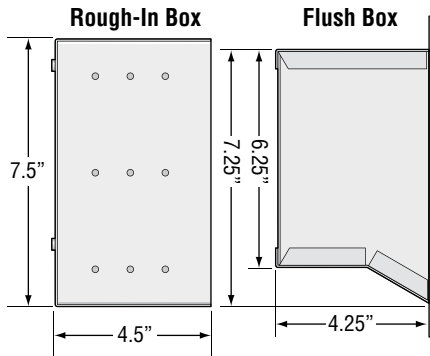

### Front Views

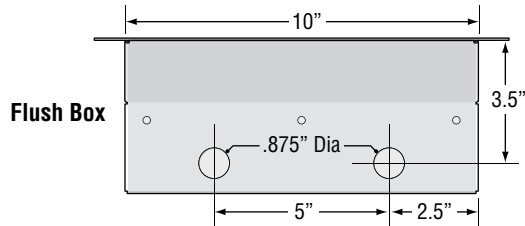
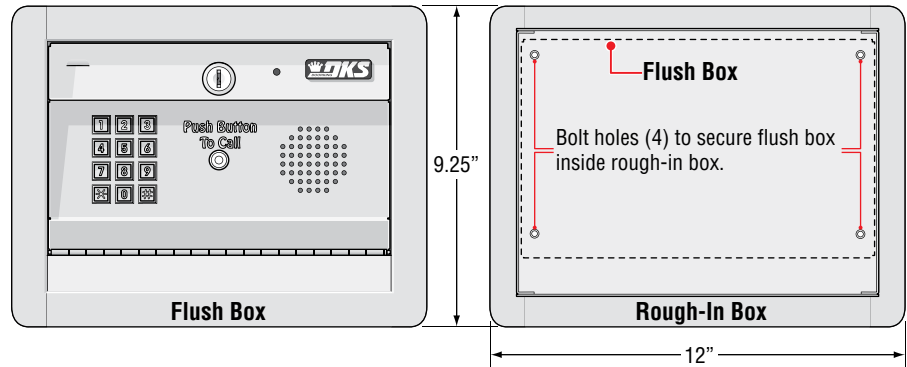

### Bottom Views

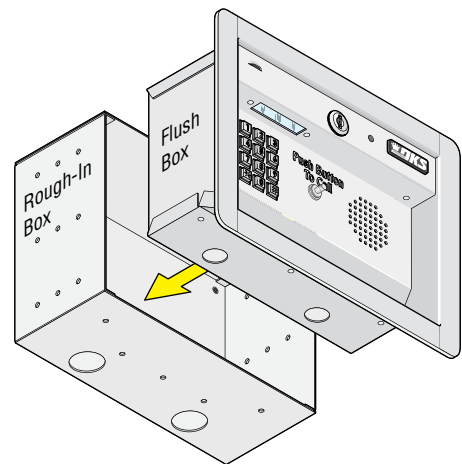
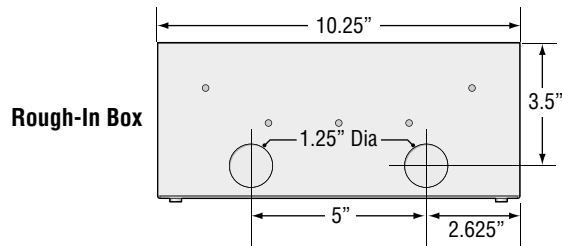

# TABLE OF CONTENTS

<b>SPECIFICATIONS</b>	<b>1</b>
<b>Features</b>	<b>1</b>
Surface Mount Dimensions	2
Wall Mount Dimensions	2
Flush Mount Dimensions	3
<b>Important Notices</b> FCC - United States, DOC - Canada	<b>4</b>
<b>General Information</b> Installation Guidelines and Safety Information	<b>5</b>
<b>SECTION 1 - INSTALLATION</b>	<b>8</b>
<b>1.1 Mount the 1812 Classic</b>	<b>8</b>
Different Mounting Configurations of the 1812 Classic Models	9-10
<b>1.2 Install By-Pass Board for “Telephone Mode” Configurations</b>	<b>11</b>
<b>1.3 Telephone Line Wire</b>	<b>12</b>
<b>1.4 Power Wiring</b>	<b>13</b>
<b>1.5 Grounding and Surge Suppression</b>	<b>13</b>
<b>1.6 Wire One 1812 to a Telco Line - Telephone Mode</b>	<b>14</b>
<b>1.7 Wire One 1812 to the Internet - Telephone Mode</b>	<b>15</b>
<b>1.8 Wire Multiple 1812s: Telco/Internet - Telephone Mode</b>	<b>16</b>
<b>1.9 Wire One 1812 - Intercom Mode</b>	<b>17</b>
<b>1.10 Wire Multiple 1812s - Intercom Mode</b>	<b>18</b>
<b>1.11 Main Terminal Description</b>	<b>19</b>
<b>SECTION 2 - PROGRAMMING</b>	<b>19</b>
<b>2.1 Programming Methods</b>	<b>19</b>
<b>2.2 Master Code</b>	<b>20</b>
<b>2.3 System Parameters Programming</b>	<b>21</b>
Programming from the System Keypad	21
Programming from a Touch-Tone Telephone	21
<b>Quick Reference Table</b>	<b>22</b>
2.3.1 Phone Mode or Intercom Mode	23
2.3.2 System Set-Up Code	23
2.3.3 Talk Time	23
2.3.4 Relay Strike Time	24
2.3.5 Tone Open Numbers	24
2.3.6 Answer Incoming Call on X Rings	25
2.3.7 Answer Incoming Call - Enable / Disable	25
<b>2.4 Time Functions</b>	<b>26</b>
2.4.1 Time and Date Calendar Chip Programming	26
2.4.2 Do Not Disturb Time Zone Programming	26
2.4.3 Automatic Relay Activation Time Zones Programming	27
2.4.4 Access Code Time Zone Programming	27
2.4.5 Call Forward Time Zone Programming	28
2.4.6 “Flash ” Access Code Time Zone Programming (One Day Only)	28

# TABLE OF CONTENTS

<b>2.5 Programming Dial-Out Functions</b>	<b>29</b>
2.5.1 Call Forward Phone Number Programming	29
2.5.2 Call Forward - Enable / Disable	29
2.5.3 Preprogrammed Phone Numbers "Dial a Phone Number"	29
<b>2.6 Access Codes to Operate Access Control Devices</b>	<b>30</b>
2.6.1 Access Code Programming	30
2.6.2 Delete an Access Code	30
2.6.3 Delete All Access Codes	30
<b>SECTION 3 - ADJUSTMENTS</b>	<b>31</b>
Speaker Volume	31
Microphone Gain	31
Interface Board LED Status	31
System Keypad and Push To Call Button	31
<b>SECTION 4 - OPERATING INSTRUCTIONS</b>	<b>32</b>
<b>4.1 Calling the Homeowner's Phone from the 1812</b>	<b>32</b>
<b>4.2 Call Waiting</b>	<b>32</b>
<b>4.3 Preprogrammed Phone Numbers</b>	<b>32</b>
<b>4.4 Access Codes</b>	<b>33</b>
Homeowner's Programming Instructions (From Home Phone or 1812)	
<b>4.5 Call Forward - Enable / Disable</b>	<b>33</b>
<b>4.6 Call Forward Time Zone - Enable / Disable</b>	<b>34</b>
<b>4.7 Do Not Disturb - Enable / Disable</b>	<b>34</b>
<b>4.8 Access Code Time Zone - Enable / Disable</b>	<b>34</b>
<b>4.9 Auto Relay Activation Time Zones - Enable / Disable</b>	<b>34</b>
<b>4.10 Answer Incoming Call - Enable / Disable Only from Phone</b>	<b>34</b>
<b>4.11 Relay Activation Check</b>	<b>35</b>
<b>4.12 Remote Programming</b>	<b>35</b>
<b>4.13 Remote Relay Activation</b>	<b>35</b>
<b>4.14 Switch Input Operation (Terminals 6, 7, 8 &amp; 9)</b>	<b>35</b>
<b>SECTION 5 - MAINTENANCE</b>	<b>36</b>
<b>5.1 Troubleshooting</b>	<b>36</b>
<b>5.2 1812 Classic Wiring Schematic</b>	<b>36</b>
<b>5.3 Phone Line Polarity</b>	<b>37</b>
<b>5.4 Isolating Noise Problems</b>	<b>38</b>
<b>5.5 Troubleshooting Table</b>	<b>38-39</b>
<b>5.6 Accessories</b>	<b>40</b>
<b>5.7 Programmed Information Log Sheets</b>	<b>41-42</b>

Master Code, Tone Open Numbers, Do Not Disturb, Call Forward, Access Codes and Automatic Relay Activation time zones.  
Preprogrammed Phone Numbers, Access Code Log Sheet (01-25 Location Codes for Relay 1, 26-50 Location Codes for Relay 2).

# Important Notices

## FCC – United States

This equipment has been tested and found to comply with the limits for a class A digital device, pursuant to Part 15 of the FCC Rules and Regulations. These limits are designed to provide reasonable protection against harmful interference when the equipment is operated in a commercial environment. This equipment generates, uses, and can radiate radio frequency energy and, if not installed and used in accordance with the instruction manual, may cause harmful interference to radio communications. Operation of this equipment in a residential area is likely to cause harmful interference in which case the user will be required to correct the interference at his own expense.

FCC Registration Number: **DUF6VT-12874-0T-T**

## DOC - Canada

The Canadian Department of Communications label identifies certified equipment. This certification means that the equipment meets certain telecommunications network protective, operational, and safety requirements. The Department does not guarantee the equipment will operate to the users satisfaction.

Before installing this equipment, users should ensure that it is permissible to be connected to the facilities of the local telecommunications company. The equipment must also be installed using an acceptable means of connection. The customer should be aware that compliance with the above conditions may not prevent degradation of service in some situations.

Repairs to certified equipment should be made by an authorized Canadian maintenance facility designated by the supplier. Any repairs or alterations made by the user to this equipment, or equipment malfunctions, may give the telecommunications company cause to request the user to disconnect the equipment.

Users should ensure, for their own protection, that the electrical ground connections of the power utility, telephone lines, and internal metallic water pipe system, if present, are connected together. This precaution may be particularly important in rural areas.

CAUTION: Users should not attempt to make such connections themselves, but should contact the appropriate electric inspection authority, or electrician, as appropriate.

DOC Registration Number: **1736 4507 A**

## Notice:

The Load Number (LN) assigned to each terminal device denotes the percentage of the total load to be connected to a telephone loop which is used by the device, to prevent overloading. The termination on a loop may consist of any combination of devices subject only to the requirement that the sum of the load numbers of all the devices does not exceed 100.

## Notice:

DoorKing does not provide a power transformer on units sold into Canada. Use only transformers that are CSA listed to power the telephone entry system. The model 1812 Classic requires a 24-volt, 20 VA transformer.

## Listing:

This product has been tested to and found to be in compliance with the U.L 294 Safety Standard by Intertek Testing Services NA Inc. (a Nationally Recognized Testing Laboratory) and is ETL listed.



# General Information

- Prior to beginning the installation of the telephone entry system, we suggest that you become familiar with the instructions, illustrations, and wiring guidelines in this manual. This will help insure that you installation is performed in an efficient and professional manner.
- The proper installation of the telephone entry panel is an extremely important and integral part of the overall access control system. Check all local building ordinances and building codes prior to installing this system. Be sure your installation is in compliance with local codes.
- When used to control a door or pedestrian gate, try to locate the telephone entry system as near as possible to the entry point. The unit should be mounted on a rigid wall to prevent excessive shock and vibration from closing doors or gates. Continuous vibration and shock from slamming doors or spring-loaded pedestrian gates will damage the circuit board.  
**Under no circumstances should the unit be mounted directly to a moving door or gate.**
- **ADA mounting requirements for door control.** The requirements below apply only when the telephone entry system is being used to control entry through a public door only. If this system is used to control entry through a vehicular gate or private entrance, the dimensions noted below do not apply.
  1. If the clear floor space allows only forward approach to the system, the maximum high forward reach allowed is 48 inches above grade to the top of the keypad.
  2. If the high forward reach to the system is over an obstruction of greater than 20 inches but less than 25 inches, the maximum high forward reach allowed is 44 inches above grade to the top of the keypad.
  3. If the clear floor space allows parallel approach by a person in a wheelchair, the maximum high side reach shall be 54 inches above grade to the top of the keypad.
  4. If the high side reach is over an obstruction of 24 inches or less, the maximum high side reach allowed is 46 inches above grade to the top of the keypad.
- **When used to control a vehicular gate with an automatic gate operator, the telephone entry system must be mounted a minimum of ten (10) feet away from the gate and gate operator, or in such a way that a person cannot operate the entry system and/or touch the gate or gate operator at the same time.**
- Be sure that the system is installed so that it is not directly in the traffic lane. Goose neck mounting post and kiosks work well for these type systems. When planning where to locate the system, take into consideration traffic lane layouts, turn around lanes for rejected access, conduit runs, power availability, etc.
- Environmental factors must also be taken into account. Surface mount units are designed for direct outdoor installations, however it is preferable to protect them from direct exposure to driven rain or snow whenever possible. Flush mount units must be protected from direct exposure to the elements.
- This telephone entry system contains a number of static sensitive components that can be damaged or destroyed by static discharges during installation or use. Discharge any static prior to removing the circuit board from the lobby panel by touching a proper ground device.
- **Instruct the end user to read and follow these instructions. Instruct the end user to never let children play with or operate any access control device. This Owner's Manual is the property of the end user and must be left with them when installation is complete.**

# SECTION 1 - INSTALLATION

Installation of the 1812 Classic Telephone Entry System involves the installation of the hardware, by-pass board, and the wiring of these components. Be sure that all dirt, metal or wood debris is removed from inside after mounting it. Any debris inside could damage the control board and cause the 1812 Classic system to malfunction during operation.



When the 1812 Classic is used to control a vehicular gate with an automatic gate operator, it must be mounted a minimum of ten (10) feet away from the gate and gate operator, or in such a way that a person cannot operate the 1812 Classic system and/or touch the gate or gate operator at the same time.

## 1.1 Mount the 1812 Classic

Use the specification dimensions on pages 2 and 3 to help with the installation of your chosen 1812 Classic model.

### Remove the Control Board

The control board removal is the same for all models.

**CAUTION** The control board contains static sensitive components. Discharge any static electricity from your hands by touching a proper ground device **before** removing the control board.

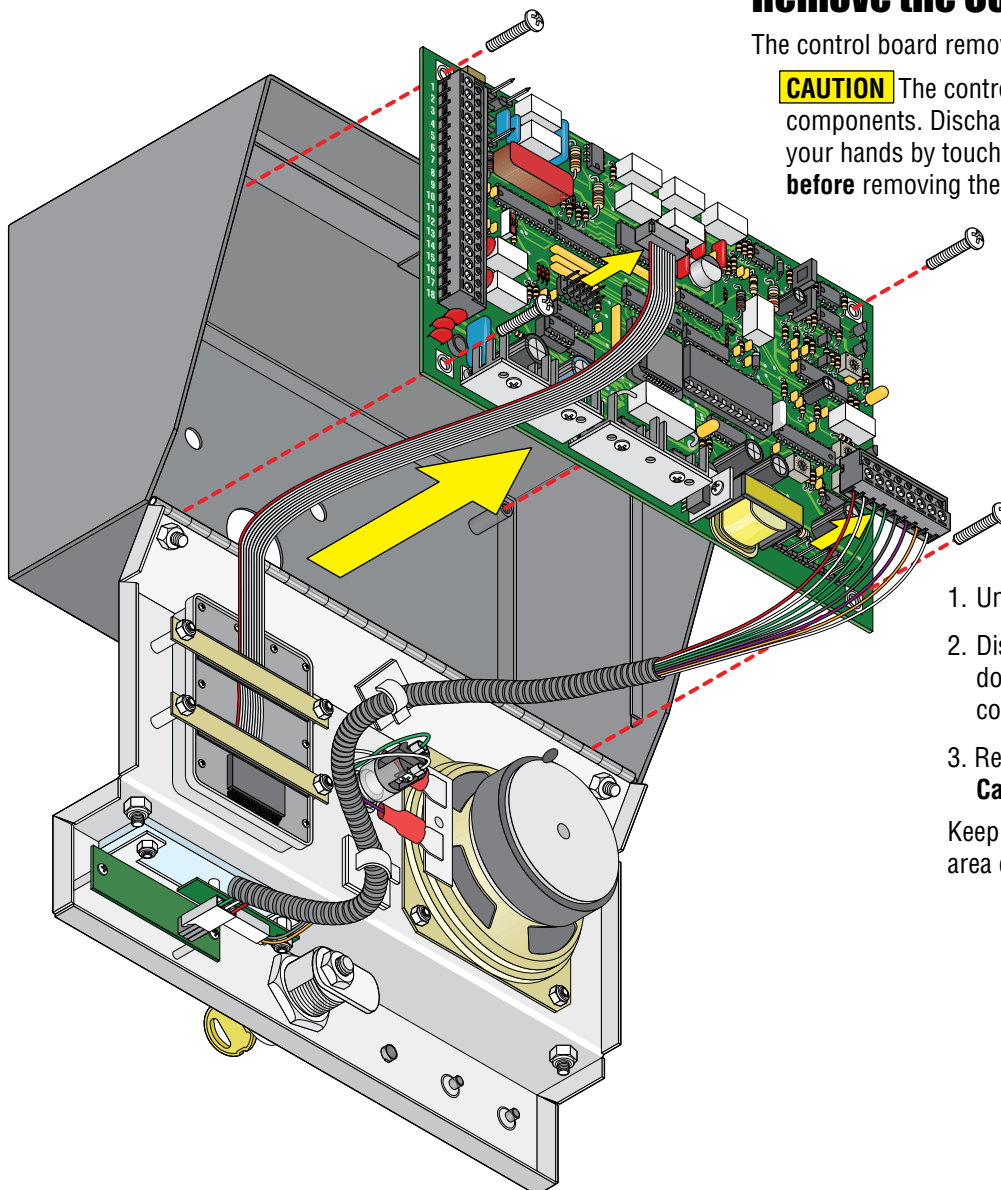

1. Unlock and open the 1812 door.
2. Disconnect the keypad plug and door accessories plug from the control board.
3. Remove the 4 screws.  
**Carefully remove control board.**

Keep the control board in a protected area during the mounting installation.

# Different Mounting Configurations of the 1812 Classic Models

Surface and Wall mount models can be mounted directly to a wall, pilaster or post mounted using a DoorKing mounting post (there are several different styles available). The flush mount model is designed to be mounted into a pilaster, wall or kiosk. In any case, be sure it is securely mounted and is not subject to continuous vibration from closing doors or gates.

## Mount on a Mounting Post

Use existing 4 holes in cabinet box to bolt the surface or wall mount models on a DoorKing mounting post. Use the hardware that is supplied with the mounting post.

Note: A gooseneck mounting post anchored in concrete does not make a good ground.

**IMPORTANT** Choose how your 1812 will function (Telephone Mode or Intercom Mode) on pages 14 thru 18 and run the indicated wires to the cabinet. Run ALL wires that will be needed during the cabinet installation.

## Mount Directly to a Wall or Pilaster

Use the 4 existing holes in the cabinet box. Run conduit inside or outside of wall or pilaster if desired. Use appropriate hardware to mount the cabinet (Not supplied). Be sure that the mounting hardware does not protrude into the cabinet where it could cause a short.

Plastic screw anchors for masonry if required. (Not supplied)

Conduit  
(Shown inside wall)

## Flush Mount in a Pilaster, Wall or Kiosk

Mount rough-in box into the pilaster, wall or kiosk. Run conduit inside wall into bottom of rough-in box if desired. Use appropriate hardware (Not supplied) to secure the rough-in box in place.

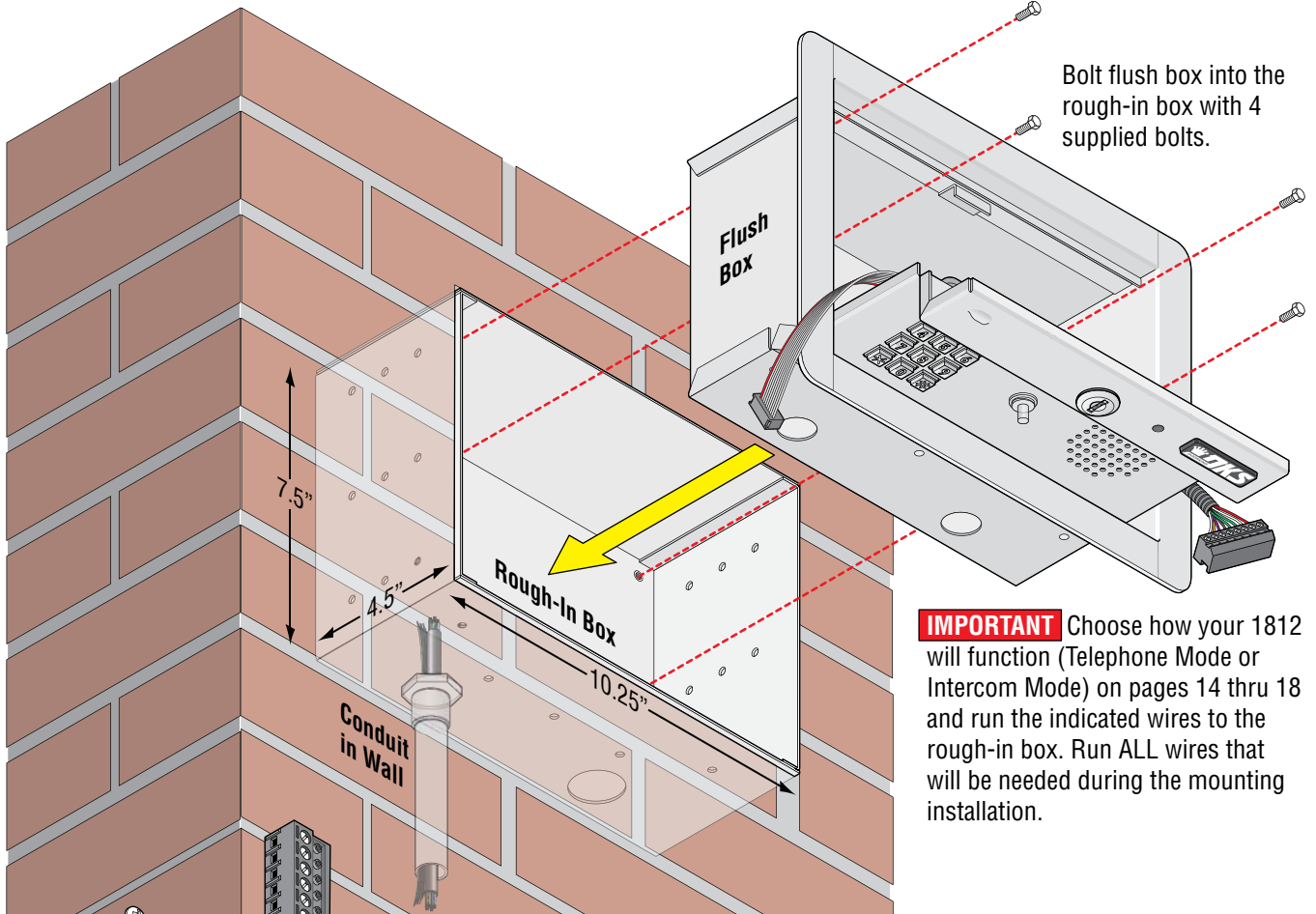

Bolt flush box into the rough-in box with 4 supplied bolts.

**IMPORTANT** Choose how your 1812 will function (Telephone Mode or Intercom Mode) on pages 14 thru 18 and run the indicated wires to the rough-in box. Run ALL wires that will be needed during the mounting installation.

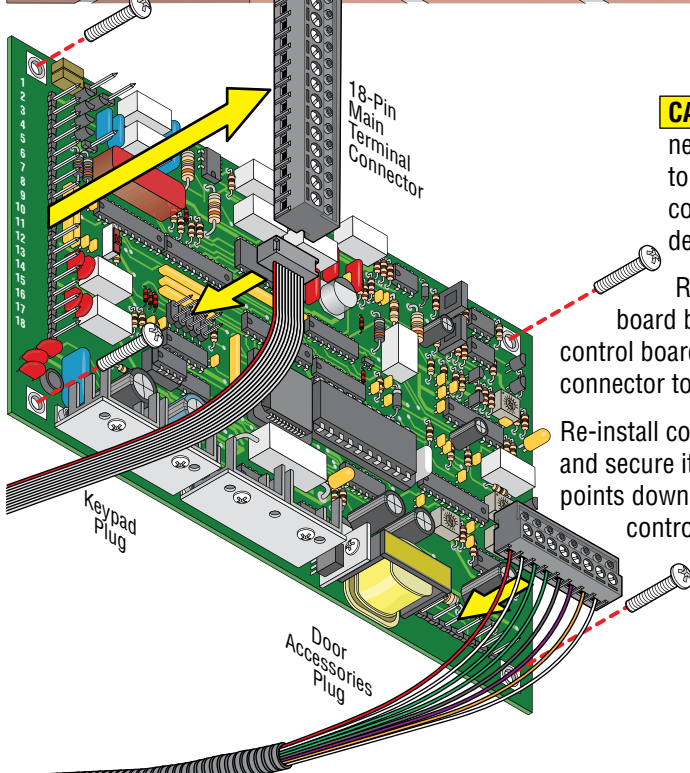

## Re-install the Control Board

**CAUTION** The control board contains static sensitive components. Discharge any static electricity from your hands by touching a proper ground device **before** re-installing the control board. Also make sure that all dirt, metal or wood debris is removed from inside before re-installing the board.

Remove the 18-pin main terminal connector from the control board by **gently** pulling it straight up. This will make wiring to the control board easier. Note the orientation and numbering sequence of the connector to correctly wire it.

Re-install control board by **carefully** routing all incoming wires around it and secure it in place with 4 screws. Re-connect the keypad plug (cable points down) and door accessories plug (red wire goes to the left) to the control board (See 5.2 on page 36 for 1812 wiring information).

Connect all wires to the 18-pin connector (See page 19). **Gently** re-connect it back on the control board. **DO NOT APPLY POWER to the 1812 at this time.**

# 1.2 Install By-Pass Board for “Telephone Mode” Configurations

The 1812’s by-pass board provides a method to by-pass the 1812 and route the incoming telephone line directly to the homeowner’s phone. **The By-Pass board IS NOT optional when using an incoming telephone line or internet (Telephone Mode) – it must be installed as part of the 1812 system. All telephone wires for the 1812 must pass through the by-pass board.** Wire the by-pass board either for a “Single 1812 - telephone mode” pages 14-15 or “Multiple 1812s - telephone mode” page 16.

Mount the by-pass board in a location that is easily accessible by the homeowner. In case of 1812 trouble or maintenance, the homeowner will use the by-pass switch on the board to route the incoming telephone line directly to their home phone. If the by-pass board is installed outdoors, it must be installed in a NEMA Type 4 enclosure (not supplied) to protect the board from direct exposure to landscape sprinklers, rain, snow and other elements.

### “Entry” switch position:

Routes incoming phone line through 1812 and then to the home phone.

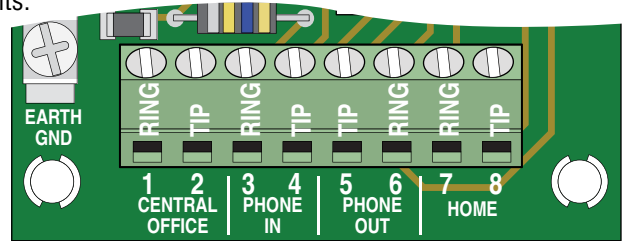
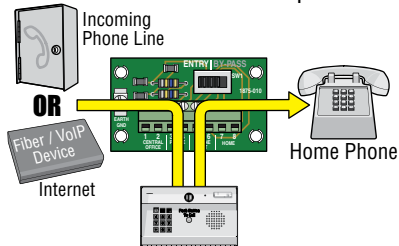

### “Tip” and “Ring” Configuration

Four (4) mounting screws supplied.

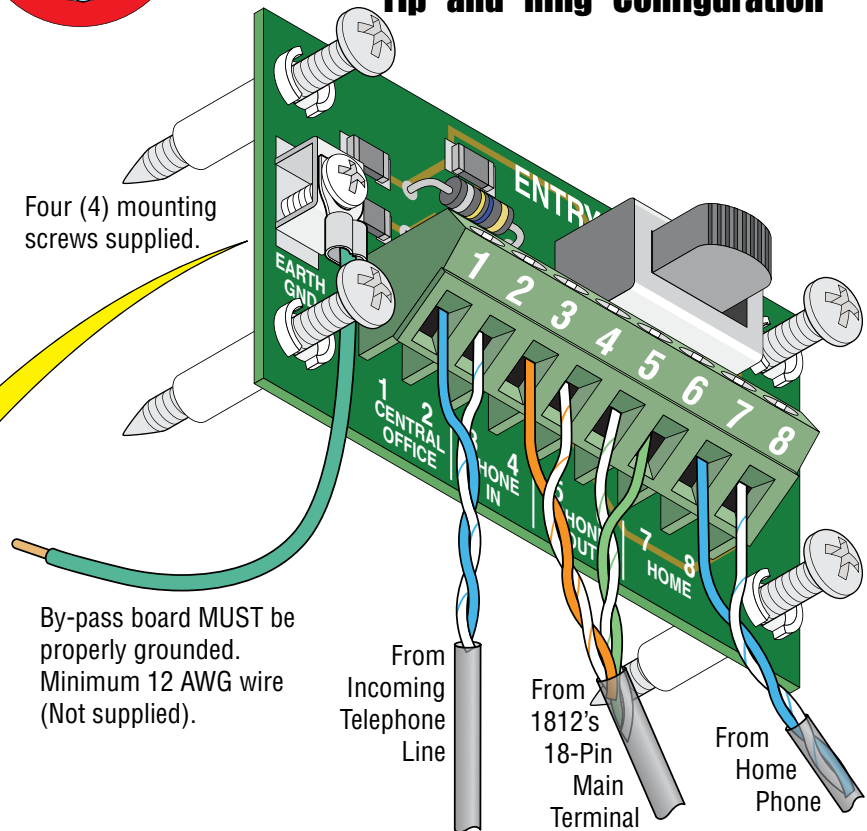

By-pass board **MUST** be properly grounded. Minimum 12 AWG wire (Not supplied).

### “By-Pass” switch position:

Routes incoming phone line directly to the home phone, bypassing 1812.

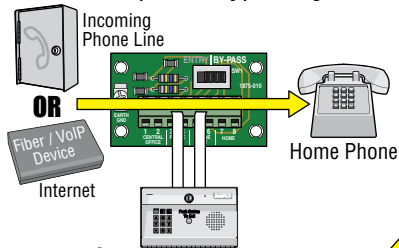

If installed outdoors.

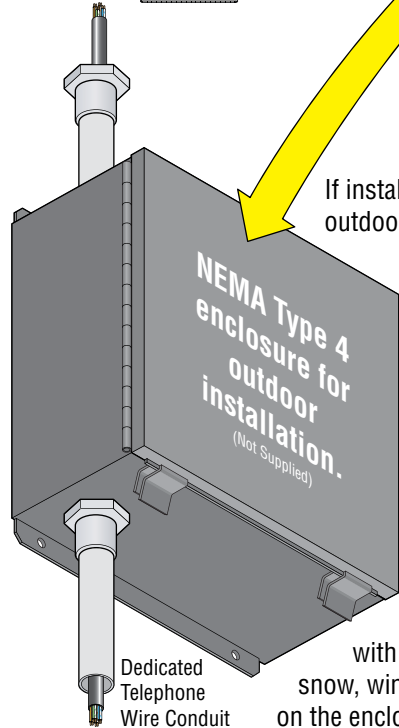

Use only twisted pair telephone wire that is rated for direct underground burial. **DO NOT** use wire that is intended for indoor applications. **Recommend Cat5e Gel Filled (flooded) UV Resistant Direct Burial Cable in conduit.** **DO NOT** run telephone wires and high voltage wires in the same conduit. It is recommended to run all necessary wires to the by-pass board in a “dedicated” telephone wire conduit. Check the phone wire chart on next page for wire size and distances.

National Electrical Manufacturers’ Association (NEMA) - Type 4 - Enclosure constructed for outdoor use to provide a degree of protection to personnel against incidental contact with the enclosed equipment: to provide a degree of protection against falling dirt, rain, sleet, snow, windblown dust, splashing water, and that will be undamaged by the external formation of ice on the enclosure.

# 1.3 Telephone Line Wire

Be sure to observe electrical safety when working with phone lines. Phone lines carry electricity and the ring voltage can deliver a substantial jolt. The best policy is to disconnect the house phone from the phone company Network Interface Device (also known as 'Demarcation Device') before working on the wiring.

In most residential homes, the phone cable contains four wires; green, red, black, yellow. The green and red are twisted to make one pair and the black and yellow are twisted to make another pair (This allowed for the addition of a second phone line since telephones use only two wires). Most phone lines installed in the U.S. in the second half of the 20th Century have this type of wire. This type of wire is now obsolete. All new telephone projects are using Cat5 wire. If you have Cat5 wiring in your home, the conversion is simple:

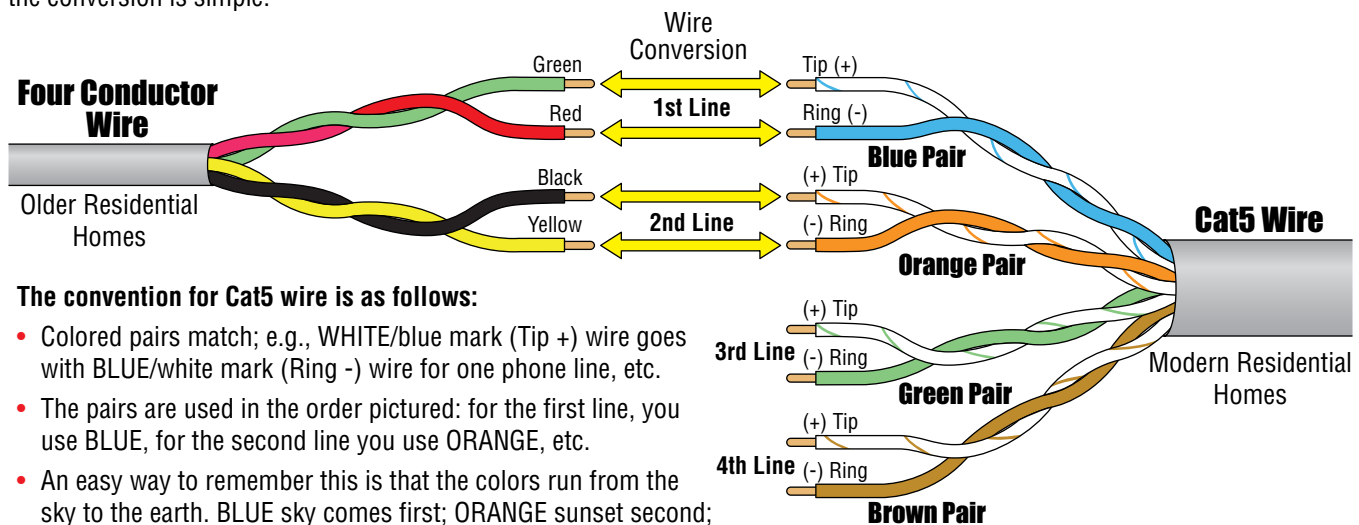

The convention for Cat5 wire is as follows:

- Colored pairs match; e.g., WHITE/blue mark (Tip +) wire goes with BLUE/white mark (Ring -) wire for one phone line, etc.
- The pairs are used in the order pictured: for the first line, you use BLUE, for the second line you use ORANGE, etc.
- An easy way to remember this is that the colors run from the sky to the earth. BLUE sky comes first; ORANGE sunset second; GREEN grass third; BROWN earth last.

**“Tip” and “Ring” Definition.** Common terms in the telephone service industry referring to the two wires or sides of an ordinary telephone line. Tip is the ground side (positive) and Ring is the battery (negative) side of a phone circuit. The ground side is common with the central office of the telephone company (telco); the battery side carries -48 volts of DC voltage when in an “Idle” or “On Hook” state.

**Phone Line Polarity.** Tip and ring reversal is mostly immaterial, except for special circuits including DID (Direct Inward Dialing) trunks, T-1 lines, and ground start lines where the field side (“terminal”) equipment (a company’s PBX switch, for example) can only function correctly with correct tip and ring polarity.

**Wire Type.** It is extremely important to use the correct type of wire in telephone applications. Since the 1812 requires phone lines to be run outdoors or in an underground environment, **we recommend that you use only wire that is rated for direct underground burial.** For example, **use Cat5e Gel Filled (flooded) UV Resistant Direct Burial Cable run in conduit for your 1812 phone line requirements.** Do not use thinly insulated brown-jacketed telephone wire (the type found in the walls of a house) for outdoor or underground phone line wiring. Using **improper wire can cause noise and hum** on the phone line. Be sure that phone wire pairs are twisted.

**Wire Size and Distance.** Phone lines can be run up to 3600 feet, provided that the proper wire size is used.

Telephone Wire Run Table

Wire Size	Max Distance
24 AWG	800 ft
22 AWG	1600 ft
20 AWG	2200 ft
18 AWG	3600 ft

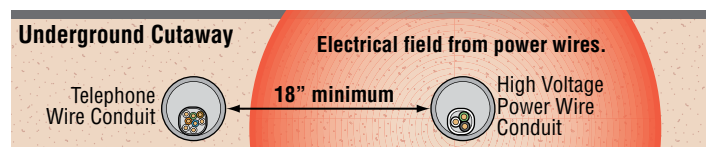

**Note:** Do not run telephone wires and high voltage power wires in the same conduit. Separate the high voltage conduit and the telephone conduit by at least 18 inches to prevent any electrical field interference that could occur.

# 1.4 Power Wiring

The 1812 Classic operates **ONLY** on 24 VAC. Use the supplied power transformer, 24 VAC, 20 VA (or U.L. listed equivalent) to power the telephone entry system. **DO NOT power any other devices (electric strikes, magnetic locks, etc.) from the 1812's power transformer.** See table below for wire run distances.

Wire Size	Max Distance
18 AWG	100 ft
16 AWG	200 ft

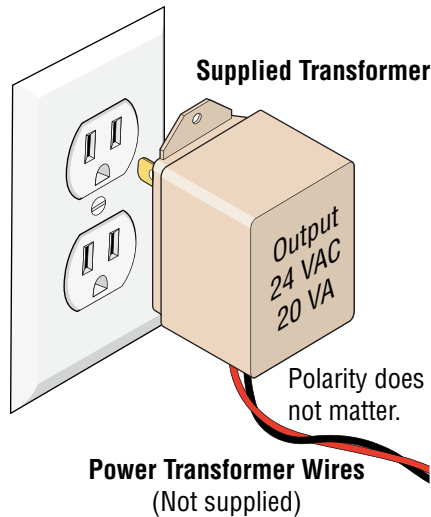

**Power Interruption Note:** The Time and Date calendar chip (Section 2, 2.6.1) in the 1812 Classic will keep time for approximately 48 hours if power to the system is lost or removed. If power is off **longer** than this, **the Time and Date will need to be reprogrammed into the system.** All other specific programming that has been done will remain intact after power has been restored.

DoorKing offers a **12 volt .8 amp hour gel cell battery** that can connect to the main terminals 9 and 10 to provide back-up power during power interruptions. (DoorKing P/N 1801-008)

# 1.5 Grounding and Surge Suppression

Proper Grounding and the use of surge suppressors can significantly reduce the chance of component failure because of static charges or surges. To be effective, ground connections should be made with a minimum 12 AWG wire to a ground point within 10 feet of the device being protected. The ground point can be at an electrical panel, a metallic cold water pipe that runs in the earth or a grounding rod driven at least 10 feet into the soil. **A gooseneck mounting post anchored in concrete does NOT make a good ground.**

## Some Acceptable Ground Sources

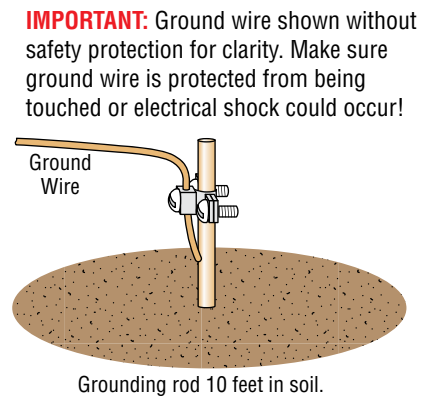
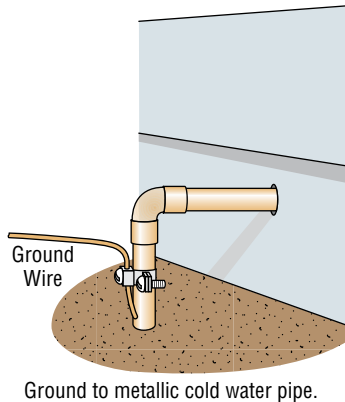
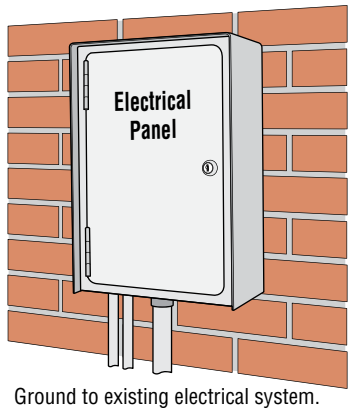

**IMPORTANT:** Ground wire shown without safety protection for clarity. Make sure ground wire is protected from being touched or electrical shock could occur!

## Telephone Line Surge Suppressor

It is highly recommended that telephone line surge suppressor (DoorKing P/N 1877-010) be installed to help protect the system from phone line power surges. Surge suppressor must be positioned 3 ft or less from the ground source, 12 AWG min.

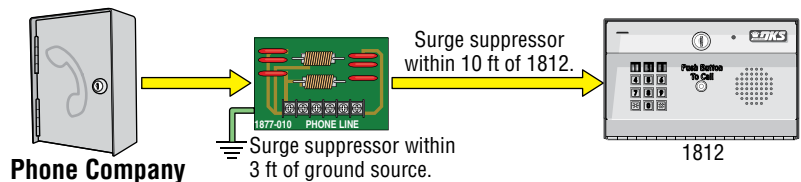

## Low Voltage Surge Suppressor

It is highly recommended that a low voltage surge suppressor (DoorKing P/N 1878-010) be installed to help protect the telephone entry system from power surges. Surge suppressor must be positioned 3 ft or less from the ground source, 12 AWG min.

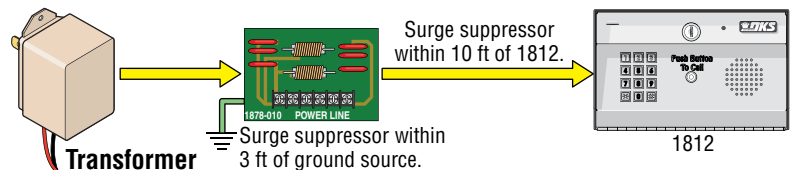

# 1.6 Wire One 1812 to a Telco Line - Telephone Mode

## ⚠️ Connect to Incoming Telephone Company's Phone Line

Locate the telephone company demarcation device. **IMPORTANT** Identify the wires that connect to the homeowner's telephone. Disconnect these 2 wires from the demarcation device and connect them to terminals #7 and #8 HOME on the by-pass board.

Connect a new twisted-pair telephone wire to the telephone company demarcation device where the 2 wires were just removed from. Connect the other end of the new twisted-pair wire to CENTRAL OFFICE terminals #1 and #2 on the by-pass board (Unless using a surge suppressor, then wire to surge board first).

Place the by-pass switch in the "By-Pass" position until the 1812 installation is complete. Test the homeowner's telephone. It should have a dial tone while the switch is in the "By-Pass" position. **See page 11.**

### Telephone Company Demarcation Point

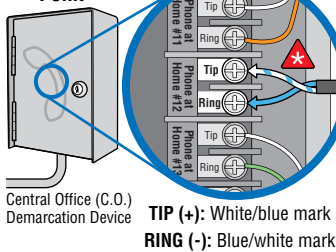

### Phone Line Surge Suppressor

DoorKing Surge Suppressor P/N 1877-010 (or equivalent) is optional but highly recommended. For best protection, surge suppressor ground wire **MUST** be 3-ft. or less in length. Use minimum 12 AWG wire. **Refer to instruction sheet included with surge board for complete information.**

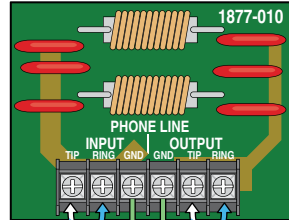

### By-Pass Board

The By-Pass board is **NOT** optional and must be installed as part of the 1812 "Telephone Mode" system.

**See page 11 for complete information.**

Single 1812:  
PHONE IN #3 connects to Main Term #1.  
PHONE IN #4 connects to Main Term #2.  
PHONE OUT #5 connects to Main Term #5.  
PHONE OUT #6 connects to Main Term #4.

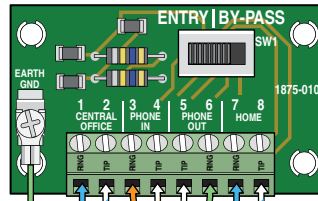

### ⚠️ Check Polarity of Telephone Line

Check for polarity on the incoming telephone line to each board and maintain polarity throughout the telephone line. One potential problem checked when a malfunction occurs in a telephone entry system is to see if the telephone line has been wired to each board with the correct polarity.

Test Example: By-pass board's CENTRAL OFFICE terminals #1 and #2. Terminal #2 must be positive (Tip +) with respect to terminal #1 (Ring -). Set a VOM meter to measure DC volts. Place the positive lead on terminal #2 and the negative lead on terminal #1. **If the meter shows a positive voltage - OK.** If the meter shows a negative voltage (needle moves off scale to the left), reverse the wires on terminals #1 and #2.

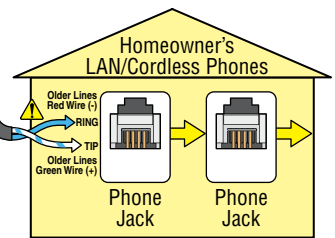

### "Existing" Alarm System Location

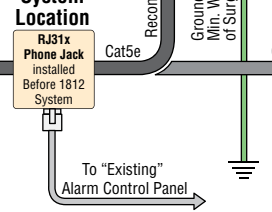

Be sure to properly ground **ALL** boards. **See previous page for acceptable grounding sources.**

### Single 1812 Wiring Configuration

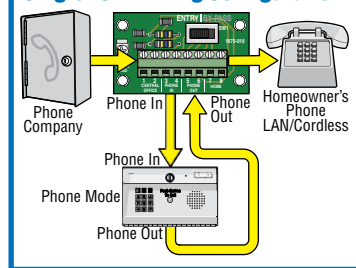

### Access Control Devices

#### "Normally Open" Vehicular Gate Operator

Use minimum 18 AWG wire for runs up to 100 feet. 16 AWG wire for runs up to 200 feet. (Term. 11 and 13)



#### Pedestrian Gate/Door

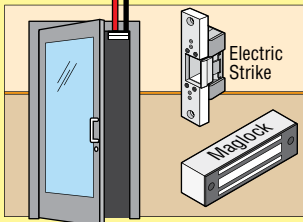

"Normally Close" with Maglock (Terminal 15 and 16)

"Normally Open" with Electric Strike (Terminal 14 and 16)

Magnetic locks or electric strikes must be powered from a separate UL Listed power transformer. **DO NOT** power strikes or magnetic locks from the 1812 power transformer. Use minimum 18 AWG wire for runs up to 100 feet; 16 AWG wire for runs up to 200 feet. It is recommended to keep power wire runs as short as possible.

### Supplied Transformer

Polarity does not matter.

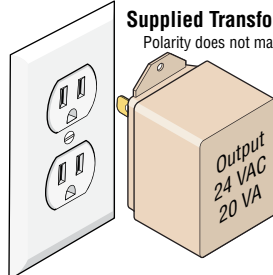

The 1812 Classic operates **ONLY** on 24 VAC. Use the supplied power transformer, 24 VAC, 20 VA (or UL listed equivalent) to power the telephone entry system. **DO NOT** power any other devices (electric strikes, magnetic locks, additional 1812s etc.) from the 1812's power transformer. **See previous page for wire size and run distances.**

**See previous page for wire size and run distances.**

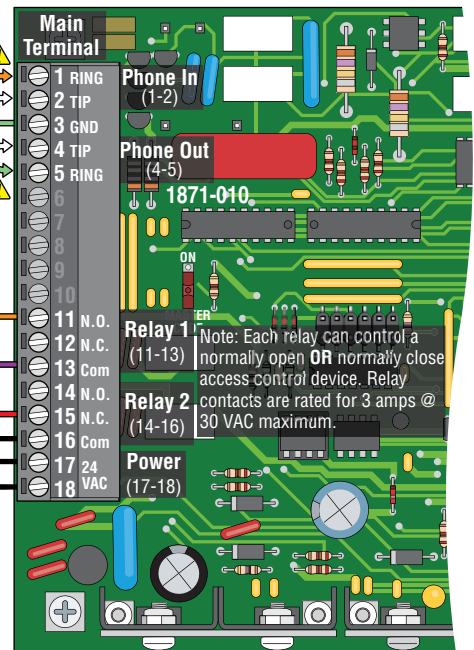

### Low Voltage Surge Suppressor

DoorKing Surge Suppressor P/N 1878-010 (or equivalent) is optional but highly recommended. For best protection, surge suppressor ground wire **MUST** be 3-ft. or less in length. Use minimum 12 AWG wire. **Refer to instruction sheet included with surge board for complete information.**

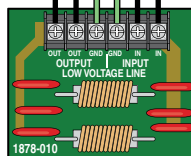



# 1.7 Wire One 1812 to the Internet - Telephone Mode

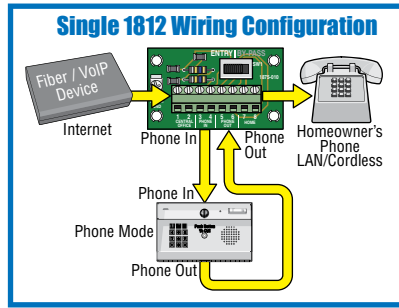
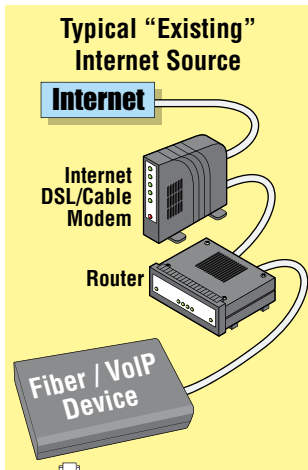

### By-Pass Board

The By-Pass board is **NOT** optional and must be installed as part of the 1812 "Telephone Mode" system. See page 11 for complete information. Single 1812:  
PHONE IN #3 connects to Main Term #1.  
PHONE IN #4 connects to Main Term #2.  
PHONE OUT #5 connects to Main Term #5.  
PHONE OUT #6 connects to Main Term #4.

**Check Polarity of Telephone Line**  
Check for polarity on the incoming telephone line to each board and maintain polarity throughout the telephone line. One potential problem checked when a malfunction occurs in a telephone entry system is to see if the telephone line has been wired to each board with the correct polarity.

Test Example: By-pass board's CENTRAL OFFICE terminals #1 and #2. Terminal #2 must be positive (Tip +) with respect to terminal #1 (Ring -). Set a VOM meter to measure DC volts. Place the positive lead on terminal #2 and the negative lead on terminal #1. If the meter shows a positive voltage - OK. If the meter shows a negative voltage (needle moves off scale to the left), reverse the wires on terminals #1 and #2.

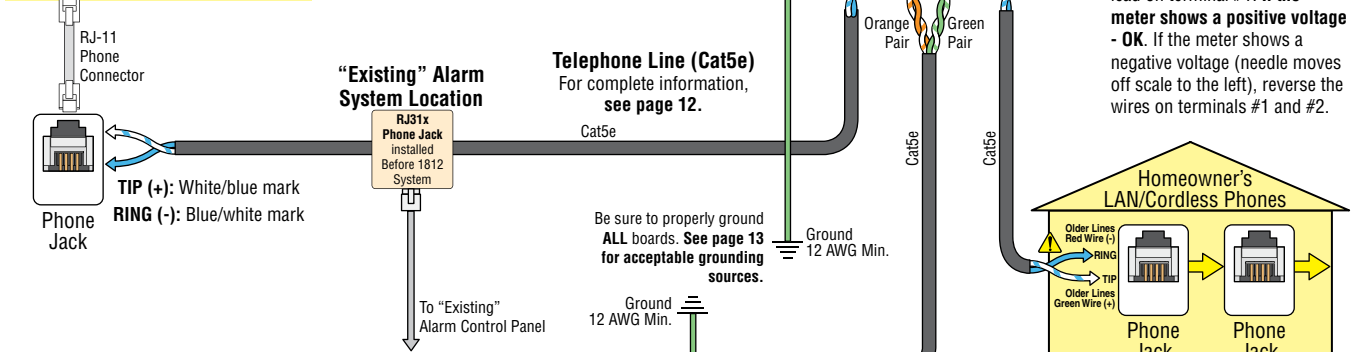

### Access Control Devices

**“Normally Open” Vehicular Gate Operator**  
Use minimum 18 AWG wire for runs up to 100 feet. 16 AWG wire for runs up to 200 feet. (Term. 11 and 13)

**“Normally Close” with Maglock**  
(Terminal 15 and 16)

**“Normally Open” with Electric Strike**  
(Terminal 14 and 16)

Magnetic locks or electric strikes must be powered from a separate UL Listed power transformer. **DO NOT** power strikes or magnetic locks from the 1812 power transformer. Use minimum 18 AWG wire for runs up to 100 feet; 16 AWG wire for runs up to 200 feet. It is recommended to keep power wire runs as short as possible.

### Supplied Transformer

Polarity does not matter.  
Output 24 VAC 20 VA

The 1812 Classic operates **ONLY** on 24 VAC. Use the supplied power transformer, 24 VAC, 20 VA (or UL listed equivalent) to power the telephone entry system. **DO NOT** power any other devices (electric strikes, magnetic locks, additional 1812s etc.) from the 1812's power transformer. See page 13 for wire size and run distances.

### Main Terminal

1	RING
2	TIP
3	GND
4	TIP
5	RING
6	
7	
8	
9	
10	
11	N.O.
12	N.C.
13	Com
14	N.O.
15	N.C.
16	Com
17	24 VAC
18	Power (17-18)

Phone In (1-2)  
Phone Out (4-5)  
1871-010

Relay 1 (11-13)  
Relay 2 (14-16)  
Note: Each relay can control a normally open OR normally close access control device. Relay contacts are rated for 3 amps @ 30 VAC maximum.

Power (17-18)

### Low Voltage Surge Suppressor

DoorKing Surge Suppressor P/N 1878-010 (or equivalent) is optional but highly recommended. For best protection, surge suppressor ground wire **MUST** be 3-ft. or less in length. Use minimum 12 AWG wire. Refer to instruction sheet included with surge board for complete information.

# 1.8 Wire Multiple 1812s: Telco/Internet - Telephone Mode

Use the previous 2 page's wiring diagrams and information to wire multiple 1812s **except** for the By-Pass board's "PHONE IN" and "PHONE OUT" terminal connections. **Up to five (5) 1812s may be wired in series** to the By-Pass board using the method shown on this page: 1st 1812's PHONE OUT to 2nd 1812's PHONE IN; 2nd 1812's PHONE OUT to 3rd 1812's PHONE IN, etc. Connect the last 1812's PHONE OUT back to By-Pass board's PHONE OUT.

## By-Pass Board

The By-Pass board is **NOT** optional and must be installed as part of multiple 1812s "Telephone Mode" system.

**See page 11 for complete information.**

Multiple 1812s:

PHONE IN #3 connects to 1st 1812 Main Term #1.

PHONE IN #4 connects to 1st 1812 Main Term #2.

PHONE OUT #5 connects to Last 1812 Main Term #5.

PHONE OUT #6 connects to Last 1812 Main Term #4.

## Maximum 1812 Wiring Configuration

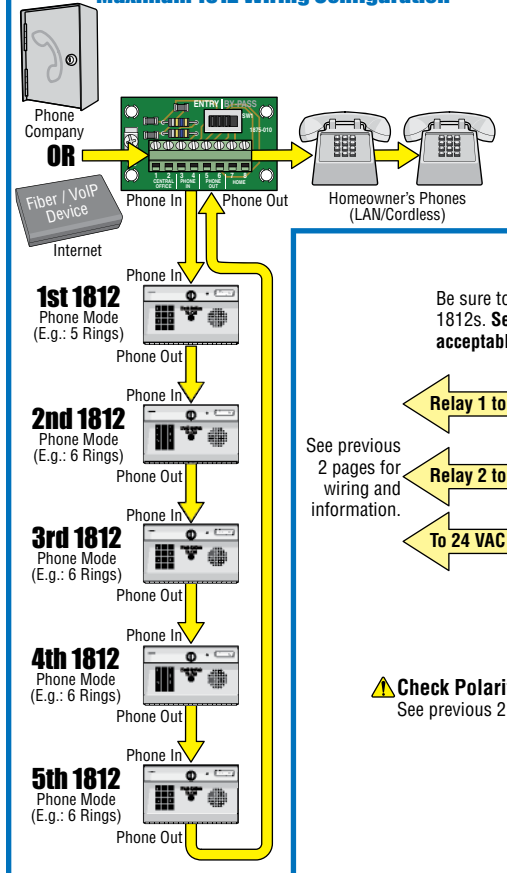

Note: **Each** 1812 must be programmed for MULTIPLE SYSTEMS, have a unique ATTENTION NUMBER (See 2.3.2 and 2.3.3) and have a unique MASTER CODE (See 2.2).

Note: The 1812 that is connected directly to the homeowner's phones (1st 1812) **must** have its "Number of Rings" programming set for 1 less than the other 1812s wired in series (See 2.3.9).

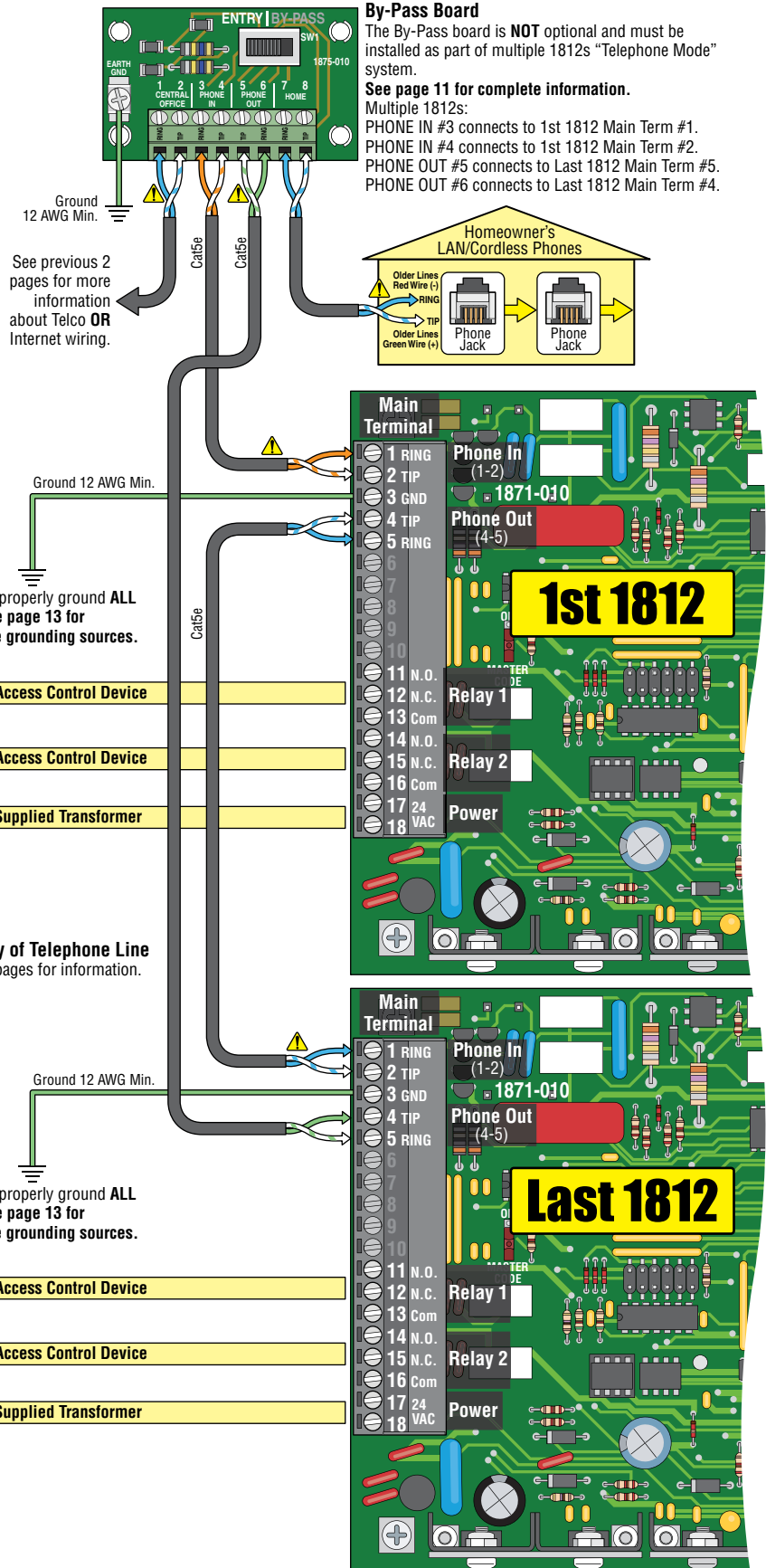

# 1.9 Wire One 1812 - Intercom Mode

## Connect to Homeowner's Telephone

When connecting directly to a single telephone or an un-used C.O. port on a PBX or KSU system, use the PHONE OUT terminals only in the 1812. It must be programmed for INTERCOM mode using this configuration.

When the 1812 is programmed for intercom mode, it provides the constant source of DC voltage necessary for communication. The intercom mode also disconnects the "PHONE IN" terminals (1 and 2) since they are not used.

Be sure that the 1812 is programmed in the intercom mode.

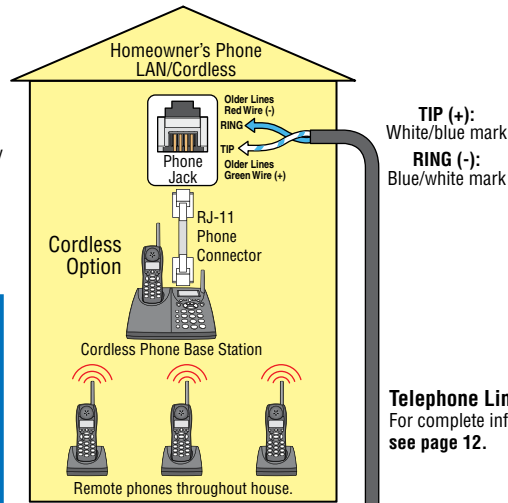

## Single 1812 Wiring Configuration

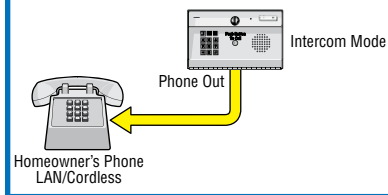

## Wireless Adapter

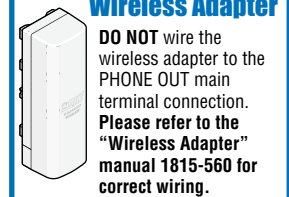

**Telephone Line**  
For complete information, see page 12.

## Access Control Devices

### "Normally Open" Vehicular Gate Operator

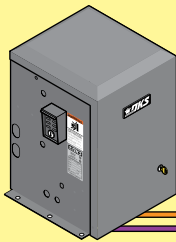

Use minimum 18 AWG wire for runs up to 100 feet. 16 AWG wire for runs up to 200 feet. (Term. 11 and 13)

### Pedestrian Gate/Door

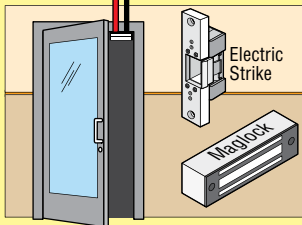

"Normally Close" with Maglock (Terminal 15 and 16)

"Normally Open" with Electric Strike (Terminal 14 and 16)

Magnetic locks or electric strikes must be powered from a separate UL Listed power transformer. **DO NOT** power strikes or magnetic locks from the 1812 power transformer. Use minimum 18 AWG wire for runs up to 100 feet; 16 AWG wire for runs up to 200 feet. It is recommended to keep power wire runs as short as possible.

Be sure to properly ground the 1812. See page 13 for acceptable grounding sources.

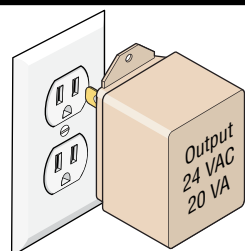

### Supplied Transformer

Polarity does not matter.

The 1812 Classic operates **ONLY** on 24 VAC. Use the supplied power transformer, 24 VAC, 20 VA (or UL listed equivalent) to power the telephone entry system. **DO NOT** power any other devices (electric strikes, magnetic locks, additional 1812s etc.) from the 1812's power transformer. See page 13 for wire size and run distances.

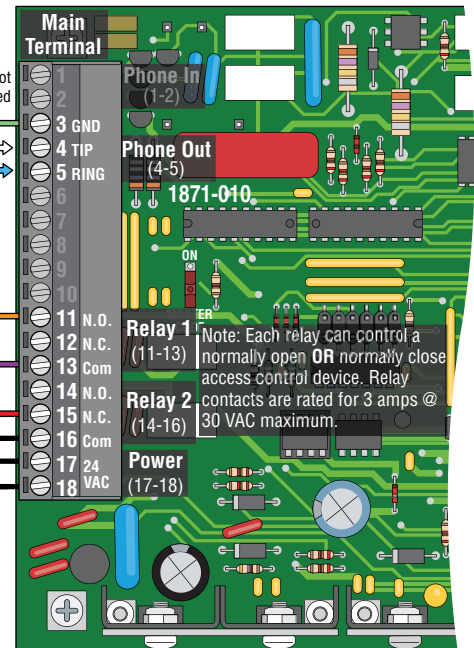

Recommended

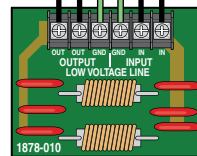

Be sure to properly ground the surge suppressor. See page 13 for acceptable grounding sources.

### Low Voltage Surge Suppressor

DoorKing Surge Suppressor P/N 1878-010 (or equivalent) is optional but highly recommended. For best protection, surge suppressor ground wire **MUST** be 3-ft. or less in length. Use minimum 12 AWG wire. Refer to instruction sheet included with surge board for complete information.

# 1.10 Wire Multiple 1812s - Intercom Mode

Up to five (5) 1812s may be wired in series using the method shown: 1st 1812's PHONE IN to 2nd 1812's PHONE OUT; 2nd 1812's PHONE IN to 3rd 1812's PHONE OUT, etc.

Each 1812 must have a unique ATTENTION NUMBER (See 2.3.3) and a unique MASTER CODE (See 2.2).

The 1812 that is the furthest away from the phone or PBX / KSU system must be programmed for INTERCOM MODE. All other 1812 units in the series are programmed for TELEPHONE MODE (See 2.3.1).

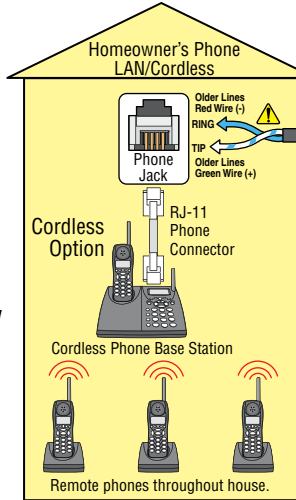

## Connect to Homeowner's Telephone

Connect the 1st 1812's PHONE OUT terminals directly to homeowner's phone or an un-used C.O. port on a PBX or KSU system.

## ⚠️ Check Polarity of Telephone Line

Check for polarity on the incoming telephone line to each 1812 board and maintain polarity throughout the telephone line to the homeowner's phone. One potential problem checked when a malfunction occurs in a telephone entry system is to see if the telephone line has been wired to each board with the correct polarity.

Test Example: 1st 1812 board's PHONE IN terminals #1 and #2. Terminal #2 must be positive (Tip +) with respect to terminal #1 (Ring -). Set a VOM meter to measure DC volts. Place the positive lead on terminal #2 and the negative lead on terminal #1. If the meter shows a positive voltage - OK. If the meter shows a negative voltage (needle moves off scale to the left), reverse the wires on terminals #1 and #2.

**TIP (+):**  
White/blue mark  
**RING (-):**  
Blue/white mark

**Telephone Line**  
For complete information, see page 12.

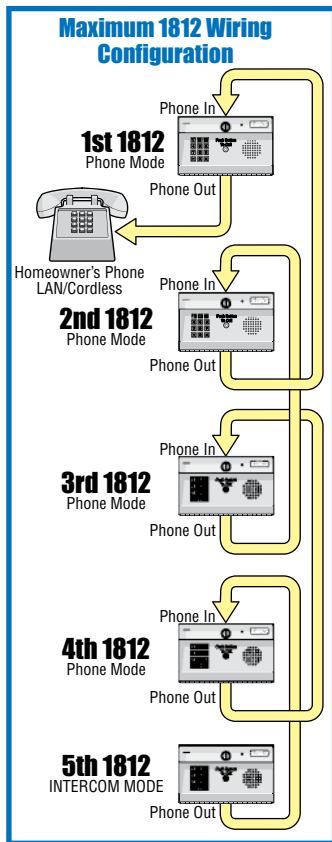

**Wireless Adapter**

DO NOT wire the wireless adapter to the PHONE OUT main terminal connection. Please refer to the "Wireless Adapter" manual 1815-560 for correct wiring.

⚠️ When multiple 1812 systems are connected together, maintain common polarity on ALL phone lines.

Be sure to properly ground ALL 1812s. See page 13 for acceptable grounding sources.

- Relay 1 to Access Control Device
- Relay 2 to Access Control Device
- To 24 VAC Supplied Transformer

Be sure to properly ground ALL 1812s. See page 13 for acceptable grounding sources.

- Relay 1 to Access Control Device
- Relay 2 to Access Control Device
- To 24 VAC Supplied Transformer

To the next 1812's PHONE OUT terminals 4 and 5 wired in the series, if desired.

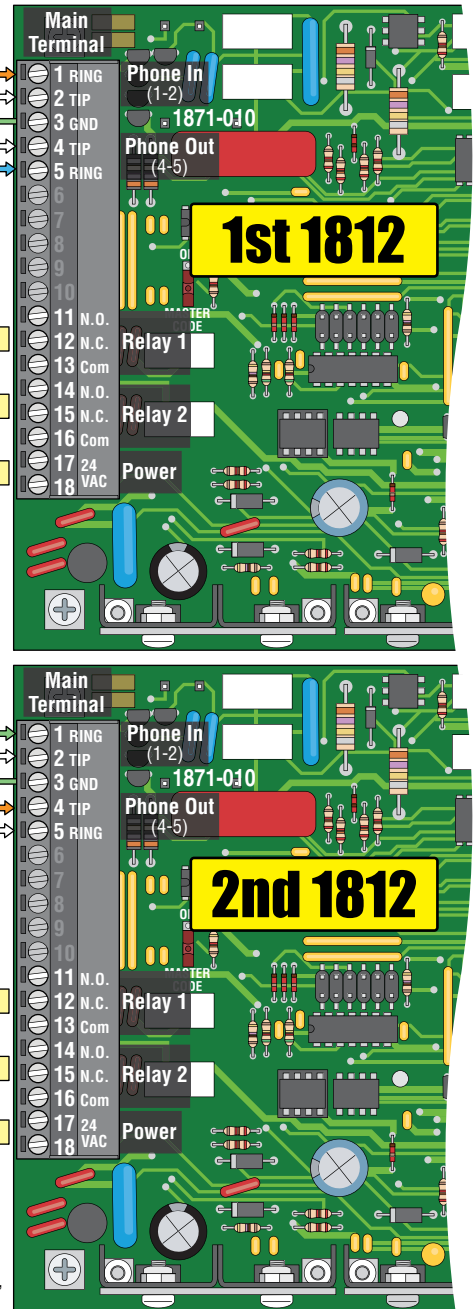

# 1.11 Main Terminal Description

- Phone In (Twisted Pair) OR Wireless Adapter (Polarity Matters!)
  - 1. Phone In (Negative - Ring)
  - 2. Phone In (Positive - Tip)
  - 3. Ground (Required)
- Phone Out (Twisted Pair)
  - 4. Phone Out (Positive - Tip)
  - 5. Phone Out (Negative - Ring)
- Time Clock
  - 6. External Time Clock Input. Connect Common to terminal 9.
- Emergency and/or Postal Entry Switch
  - 7. Switch Input Relay 1. A switch closure across terminals 7 & 9 will activate relay 1 for its programmed strike time.
  - 8. Switch Input Relay 2. A switch closure across terminals 8 & 9 will activate relay 2 for its programmed strike time.
- Back-Up Battery Power
  - 9. - 24 VDC Battery Negative. Also **Common** for terminals 6, 7 & 8.
  - 10. + 24 VDC Battery Positive.
- Relay 1 (Access Control Device)
  - 11. Relay 1 Normally Open
  - 12. Relay 1 Normally Closed
  - 13. Relay 1 **Common**
- Relay 2 (Access Control Device)
  - 14. Relay 2 Normally Open
  - 15. Relay 2 Normally Closed
  - 16. Relay 2 **Common**
- Input Power (Transformer)
  - 17. 24 VAC Input Power
  - 18. 24 VAC Input Power

External time clock input may be used to create an **additional** time zone for access codes (4.14).

**Wireless Adapter**



**DO NOT** wire the wireless adapter to the PHONE OUT main terminal connection. Please refer to the "Wireless Adapter" manual 1815-560 for correct wiring.

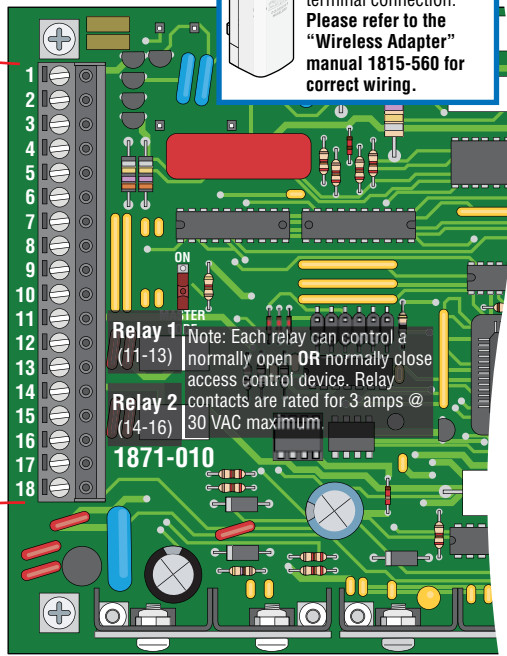

## SECTION 2 - PROGRAMMING

**Before You Start Programming: IMPORTANT!** Make sure the 1812 has power and we strongly suggest that you become familiar with these programming instructions before beginning any programming of the 1812 Classic system.

The 1812 has been programmed at the factory with many of the programming parameters already set (default setting) for a typical residential application with a single 1812. There is no need to reprogram these parameters unless you want to change them. For easy reference, refer to the chart on page 22 that list the various programming functions and their default settings.

### 2.1 Programming Methods

The 1812 Classic can be programmed from the system keypad (Keypad on the 1812) or from a touch-tone telephone connected to the system.

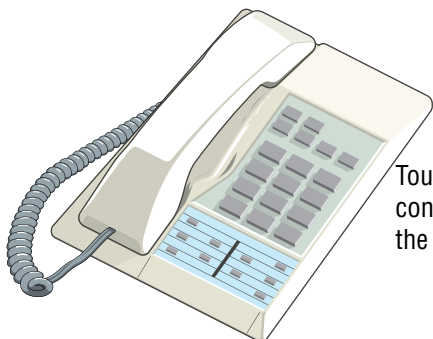
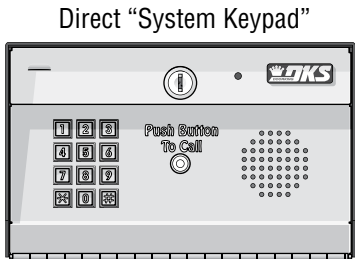

Touch-Tone Telephone connected directly to the system or off-site.

- **System Keypad (Preferred)**  
We strongly recommend that you become familiar with the entire programming sequence before attempting to program some of the more complex features of this system using the system keypad. If you make a single error in the programming steps, you will have to re-do the sequence from the beginning.
- **Touch-Tone Telephone**  
The programmable features that can be programmed using the system keypad can also be programmed using a touch-tone telephone (typically the house phone) connected to the 1812. This method of programming is useful for programming simple steps or for turning certain features ON or OFF, but is not recommended for complex programming steps.

## 2.2 Master Code

The master code is the four-digit number **REQUIRED to gain access to the system memory**. It comes from the factory pre programmed using the “**Last 4-digits of the control board serial number**” but can be reprogrammed to any 4 numbers desired. Follow the 3 steps below to reprogram the master code. Plug in 1812's 24 VAC transformer before programming.

The Master Code can **ONLY** be programmed from the system keypad.



**Step 1.** Open the cabinet of the 1812 and turn the master code switch **ON** (the small sliding switch, see below).

**Note:** After you turn ON the master code switch, the system will sound a short tone after 30 seconds if the master code is not entered. This tone will continue every 30 seconds until a new master code is entered, or until the switch is turned off.

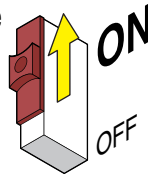

**Step 2.** Enter a four-digit master code then press \*.



Actual keystrokes used on system keypad: ? ? ? ? Then \* **“BEEP”**  
Same keystrokes as written in this manual: [ \_\_\_\_ \* (beep) ]

**Multiple 1812 Master Codes Note:** The master code number is used to distinguish each 1812 when multiple 1812s are connected together. They **CAN NOT** function together with duplicate master codes.

**Step 3.** Turn the master code switch **OFF** and close the cabinet. **You should write down your master code, see note below.**

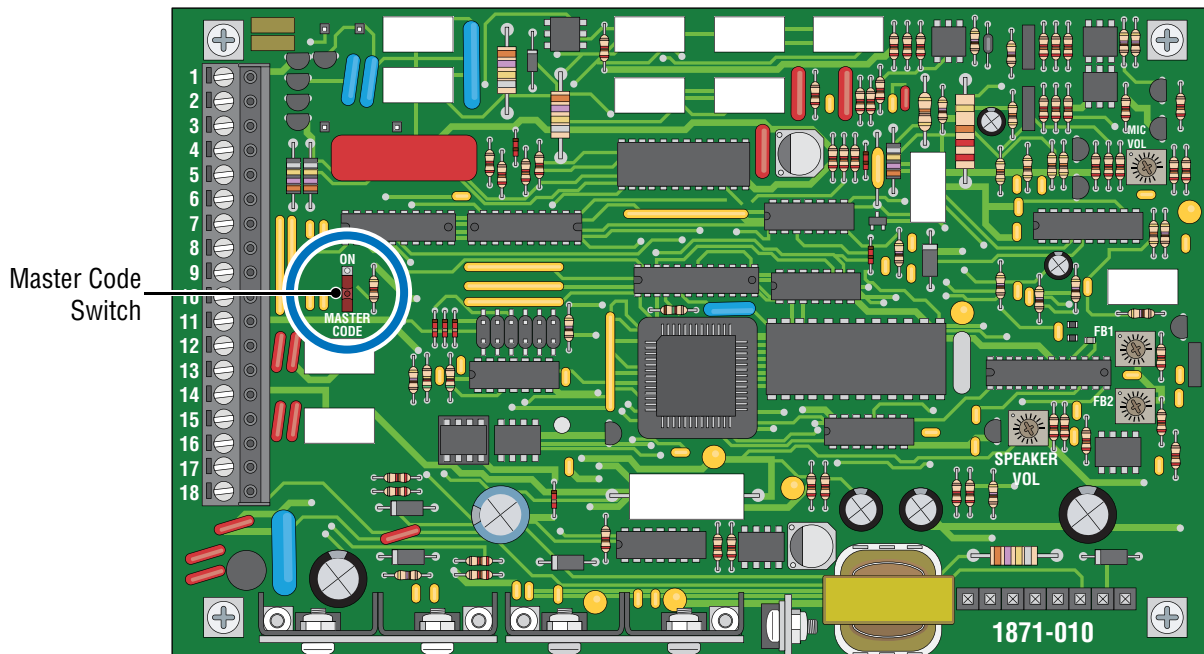

**Programming Documentation Note:** There are programming log sheets in the back of this manual to document your specific master code, and keep track of all other programming that is preformed to this 1812 Classic. Keep this with all other system documentation for future reference. **There is no way of retrieving the master code after it has been programmed in.** If you forget it, you will have to program in a new one but all other previously programmed information will remain intact.

## 2.3 System Parameters Programming

**IMPORTANT!** We strongly suggest that you read these programming instructions in their entirety before beginning any manual programming of the 1812 Classic system.

The programming table on the next page provides a quick reference to:

### Programming from the System Keypad



Follow the programming instructions as described in each section of this manual.

**IMPORTANT** The system will prompt you with short tones (**beep**) when programming steps have been correctly keyed in and with a long tone (**beeeeeep**) when all of the programming steps have been successfully completed in the sequence.

### Programming from a Touch-Tone Telephone

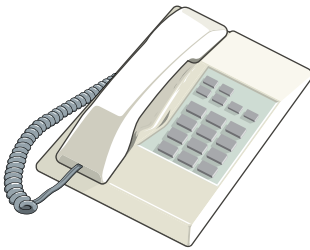

#### Homeowner's Touch-Tone Telephone

Follow these steps when programming the 1812 Classic from the **Homeowner's Touch-Tone Telephone**.

**IMPORTANT** The system will require an "ATTENTION NUMBER". The system attention number is the number that the **1812's programming mode** will respond to when called from the **Homeowner's Phone**. If more than one 1812 is sharing the phone line, be sure that each system's attention number is unique.

Note: The system attention number is **factory set to 7**. This can be changed to any number, and will have to be changed when using multiple systems on the same phone line, see section 2.3.2.

1. Press \* and then the system ATTENTION NUMBER. [**\* 7 (beep)**]
2. Follow the programming instructions as described in each section of this manual. The system will prompt you with short (beep) tones when programming steps have been followed correctly.
3. When complete, hang up. You cannot use 0# pressed together to end programming steps from a touch-tone telephone. Wait 30 seconds before calling back to program another feature.



#### Off-Site Touch-Tone Telephone

Follow these steps when programming the 1812 Classic from an **Off-Site Touch-Tone Telephone**.

**IMPORTANT** The 1812 must have "Answer incoming call - enabled", section 2.3.7.

1. Call the homeowner's telephone number. The 1812 will answer with a short beep after the programmed number of rings.
2. Follow the programming instructions as described in each section of this manual. The system will prompt you with short (beep) tones when programming steps have been followed correctly.
3. When complete, hang up. You cannot use 0# pressed together to end programming steps from a touch-tone telephone. Wait 30 seconds before calling back to program another feature.

## Quick Reference Table

	Page #	Section	Command	Factory Setting
<b>Section 2.3 System Parameters Programming</b>				
Phone Mode or Intercom Mode	23	2.3.1	* 0 6	1 (Phone Mode)
System Set-Up Code (4 #s): 1st #: Single or Multiple Systems 2nd #: System Attention Number 3rd #: Number of Home Phone Rings Before 1812 Hangs Up 4th #: Single or Double Ring	23	2.3.2	* 0 4	<b>1731</b> 1 (Single) 7 3 (3 Rings) 1 (Double Ring)
Talk Time	23	2.3.3	* 0 8	060 (60 Sec.)
Relay Strike Time	24	2.3.4	* 0 3	1 Sec
Tone Open Numbers	24	2.3.5	* 0 5	Relay 1: 9 8 7 6 Relay 2: 5 4 3 2
Answer Incoming Call on X Rings	25	2.3.6	* 1 8	12 (12 Rings)
Answer Incoming Call - Enable / Disable	25	2.3.7	* 1 5	0 (Disable)
<b>Section 2.4 Time Functions</b>				
Time and Date Calendar Chip Programming	26	2.4.1	* 3 3	Empty
Do Not Disturb Time Zone Programming	26	2.4.2	* 3 4	Empty
Automatic Relay Activation Time Zones Programming	27	2.4.3	* 3 5	Empty
Access Code Time Zone Programming	27	2.4.4	* 3 6	Empty
Call Forward Time Zone Programming	28	2.4.5	* 3 7	Empty
"Flash" Access Code Time Zone Programming (One Day Only)	28	2.4.6	* 4 5	Empty
<b>Section 2.5 Programming Dial-Out Functions</b>				
Call Forward Phone Number Programming	29	2.5.1	* 1 0	Empty
Call Forward - Enable / Disable	29	2.5.2	* 1 4	0 (Disable)
Preprogrammed Phone Numbers "Dial a Phone Number"	29	2.5.3	* 21, * 22, * 23	Empty
<b>Section 2.6 Access Codes to Operate Access Control Devices</b>				
Access Code Programming	30	2.6.1	* 0 2	Empty
Delete an Access Code	30	2.6.2	* 0 2	N / A
Delete All Access Codes	30	2.6.3	* 0 0	N / A
<b>Section 4 "From Homeowner's Phone" or 1812</b>				
"Answer incoming call MUST be Enabled" (2.3.7) to program from a phone.				
4.5 Call Forward - Enable / Disable	33	4.5	* 1 4	0 (Disable)
4.6 Call Forward Time Zone - Enable / Disable	34	4.6	* 3 7	0 (Disable)
4.7 Do Not Disturb - Enable / Disable	34	4.7	* 3 4	0 (Disable)
4.8 Access Code Time Zone - Enable / Disable	34	4.8	* 3 6	0 (Disable)
4.9 Relay Activation Time Zones - Enable / Disable	34	4.9	* 3 5	0 (Disable)
4.10 Answer Incoming Call - Enable / Disable Only from Phone	34	4.10	* 1 5	1 (Enable)
4.11 Relay Activation Check	35	4.11	N / A	N / A
4.12 Remote Programming	35	4.12	N / A	N / A
4.13 Remote Relay Activation	35	4.13	N / A	N / A



## 2.3.1 Phone Mode or Intercom Mode

**Factory setting is 1 (Phone Mode).**

The 1812 is normally connected in series with a homeowner's incoming phone line, which supplies a constant source of DC voltage. When the 1812 is connected in this manner, program the unit for PHONE mode.

If the 1812 is to be connected to an open C.O. (Central Office) port or through the internet on a key type telephone system.

If the 1812 is connected directly to a telephone without a C.O. or internet line, program the unit for INTERCOM mode. When programmed in intercom mode, the 1812 will supply the constant DC voltage necessary for operation and will disconnect the PHONE IN terminals 1 and 2 from the circuit board since these are not used in intercom mode.

If the 1812 is programmed for the intercom mode, the call forward and preprogrammed phone numbers "Dial a phone number" features **will not work**.

1. Press \* 0 6 and enter the MASTER CODE. [**\* 0 6** \_ \_ \_ \_ (beep)]
2. Press 1 \* for phone mode **OR** press 0 \* for intercom mode. [ \_ \* (beep)]
3. Press 0 # TOGETHER to end. [**0 #** (beeeeeep)]

## 2.3.2 System Set-up Code

**Factory setting is 1 7 3 1.**

These steps will program the system's "Basic" set-up. The system set-up code is a four-digit number that will program the 1812 for:

**1st digit:** Single or multiple systems on the phone line. **(Factory setting is "1" Single System)**

**2nd digit:** The systems attention number. The "attention number" is the number that the 1812 responds to when called from the residence. If more than one 1812 is sharing the phone line, be sure the attention number to each system is programmed with a unique attention number. **(Factory setting is "7")**

**3rd digit:** The number of rings to the house allowed before the system hangs up. **(Factory setting is "3" Rings)**

**4th digit:** Single or double ring to the house. **(Factory setting is "1" Double Ring)**

You will need to enter a four-digit number in step 2 (see chart below) to program the system set-up code.

1. Press \* 0 4 and enter the MASTER CODE. [**\* 0 4** \_ \_ \_ \_ (beep)]
2. Choose and enter a four-digit system set-up code (see chart below), then press \* .  
[ \_ \_ \_ \_ \* (beep)].
3. Press 0 # TOGETHER to end. [**0 #** (beeeeeep)]

4 Digit System Set-up Code	Valid #	Function
1st Digit (Step 2)	1 or 0	Enter "1" for a single system or "0" when multiple systems are sharing the same phone line.
2nd Digit (Step 2)	0 - 9	System attention number. MUST be unique when using multiple systems on same phone line.
3rd Digit (Step 2)	2 - 9	Number of home phone rings before the 1812 hangs up.
4th Digit (Step 2)	1 or 0	Enter "1" for the double ring or enter "0" for the standard long ring.

## 2.3.3 Talk Time

**Factory setting is 060 (60 Seconds).**

This programming sequence sets the maximum time allowed for conversation when the 1812 places a call to the homeowner's house, **or** if call forwarding is active, **or** if any of the dial out numbers are used. Talk time can be set from 1 second up to 255 seconds (4 minutes, 15 seconds) and is entered as a three-digit number. For example, to set a talk time of 30 seconds, enter 030 in step 2.

1. Press \* 0 8 and enter the MASTER CODE. [**\* 0 8** \_ \_ \_ \_ (beep)]
2. Enter the talk time code (001-255), then press \* . [ \_ \_ \* (beep)]
3. Press 0 # TOGETHER to end. [**0 #** (beeeeeep)]

## 2.3.4 Relay Strike Time

**Factory setting for Relays 1 and 2 is 01 (1 Second).**

System relays 1 and 2 are the two relays on the 1812 main circuit board. These steps will program relay 1 and relay 2 strike times. Relay strike times can be programmed from 1/4 second - enter 0 0 \* in step 3, up to 99 seconds - enter 9 9 \* in step 3.

1. Press \* 0 3 and enter the MASTER CODE. [**\* 0 3 \_ \_ \_ \_ (beep)**]
2. Enter a relay number (1 or 2), then press \*. [**\_ \*(beep)**]
3. Enter the two-digit strike time (00-99), then press \*. [**\_ \_ \*(beep)**]
4. Repeat steps 2 and 3 to set the other relay strike time if necessary.
5. Press 0 # TOGETHER to end. [**0 # (beeeeeep)**]

## 2.3.5 Tone Open Numbers

**Factory setting is 9876 for Relay 1; 5432 for Relay 2.**

These steps will program the tone open number(s) for each relay in the system (each relay is programmed independently). You will need to enter a four-digit number (see chart below) to set each relay in step 3. If a function is not desired, enter # in place of the digit. Use a different number for each of the four-digits in step 3 when multiple functions are desired.

Example 1: If you want the relay to have a “momentary activation” function only, and you want it to activate when the number 9 is pressed, enter 9 # # # \* in step 3.

Example 2: If you only want the relay to hold open when the number 8 is pressed and the relay deactivated when the number 7 is pressed, enter # 8 7 # \* in step 3.

1. Press \* 0 5 and enter the MASTER CODE. [**\* 0 5 \_ \_ \_ \_ (beep)**]
2. Enter a relay number (1 or 2), then press \*. [**\_ \*(beep)**]
3. Choose and enter a four-digit tone open number code (see chart below), then press \*. [**\_ \_ \_ \_ \*(beep)**]  
If a tone open function is not desired, enter # in place of a number.
4. Repeat steps 2 and 3 to set the other relay tone open number(s) if desired.
5. Press 0 # TOGETHER to end. [**0 # (beeeeeep)**]

4 Digit Tone Open Number Code	Function
1st Digit (Step 3)	Momentary activation. Relay will activate for its programmed relay strike time.
2nd Digit (Step 3)	Hold open (latch). Relay will activate and remain activated until commanded to deactivate.
3rd Digit (Step 3)	Deactivates an activated relay. Also hang up tone number to DENY ACCESS to guest.
4th Digit (Step 3)	Hold open 1 hour. Relay will activate for 1 hour and then deactivate itself.

### Tone Open Number Factory Settings:

#### Relay 1

- 9** - Momentary Activation
- 8** - Hold Open
- 7** - Deactivate/Hang Up tone
- 6** - Hold Open 1 Hour

#### Relay 2

- 5** - Momentary Activation
- 4** - Hold Open
- 3** - Deactivate/Hang Up tone
- 2** - Hold Open 1 Hour

### Example for Relay 1 Factory Settings:

If you wish to GRANT ACCESS to a guest, then dial “9” to open the gate.

If you wish to DENY ACCESS to a guest, then dial “7” and Hang-Up.

## 2.3.6 Answer Incoming Call on X Rings

Factory setting is 12 (12 Rings).

This programming section sets the number of rings that the 1812 will allow to pass through the system before it picks up the call to allow remote programming or remote relay activation of the system. The number of rings to answer can be set from 1 to 99 rings and must be entered as a two-digit number.

For example, if you want the 1812 to answer the call after the sixth ring, enter 0 6 \* in step 2.

Once the number of rings has been programmed, the system's "answer incoming call" MUST also be **enabled** for this to function (See 2.3.7 below).

**Important!** If more than one 1812 is connected in the system (2.3.2 set for multiple systems), the **ALL** 1812s that are connected directly to the homeowner's phone must have the "Answer Incoming Call" set for the **SAME** number of rings **AND** more rings than the answering machine's number of rings.

1. Press \* 1 8 and enter the MASTER CODE. [**\* 1 8** \_ \_ \_ \_ (beep)]
2. Enter the number of rings (01-99), then press \*. [ \_ \_ \* (beep)]
3. Press 0 # TOGETHER to end. [**0 #** (beeeeeep)]

Examples:

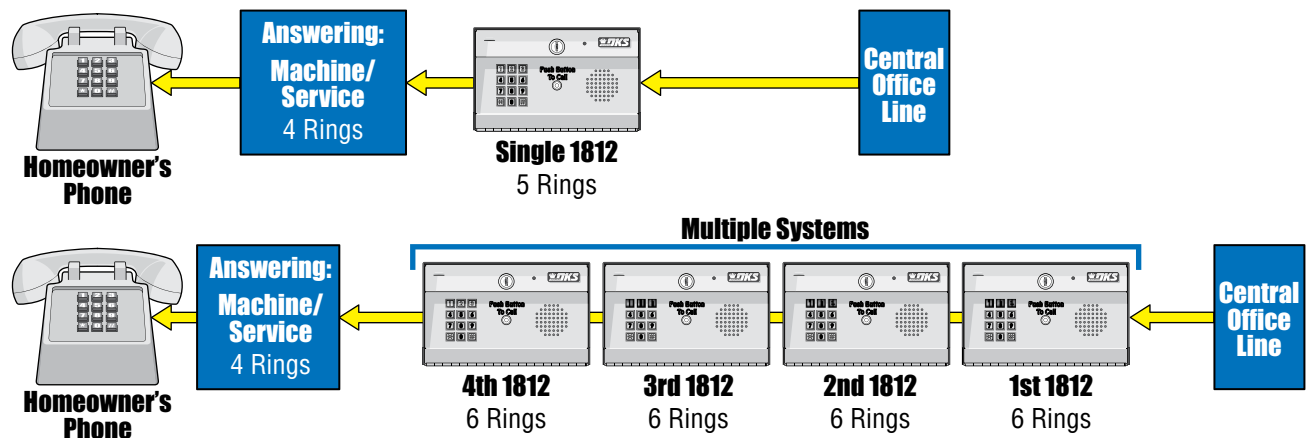

**Answering Machine/Service Note:** If the homeowner has an answering machine or answering service on their phone, this may present a problem. If the answering machine/service is set to answer on the fourth ring, and the 1812 is set to answer on the 6th ring, the answering machine/service will always pick-up the call before the 1812 does. On the other hand, if the 1812 is set to answer on the fourth ring, and the answer machine/service is set to pick-up the call on the 5th ring, the 1812 will always answer the call unless the answer incoming call is disabled (See 2.3.7 below).

## 2.3.7 Answer Incoming Call - Enable / Disable

Factory setting is 0 (Disable).

The 1812 can be programmed to answer calls placed to the home from an off-site phone line. When this feature is enabled, the 1812 will pick-up the call after the number of rings programmed in section 2.3.6. This then allows remote programming or remote relay activation of the system. If this feature is disabled, the 1812 will not answer any call regardless of the number of rings programmed in 2.3.6.

1. Press \* 1 5 and enter the MASTER CODE. [**\* 1 5** \_ \_ \_ \_ (beep)]
2. Press 0 \* to Disable this feature **OR** press 1 \* to Enable this feature. [ \_ \* (beep)]
3. Press 0 # TOGETHER to end. [**0 #** (beeeeeep)]

## 2.4 Time Functions

### 2.4.1 Time and Date Calendar Chip Programming

This programming sequence programs the calendar chip in the 1812 system for the current time and date. The calendar chip must be programmed if any of the time related features are going to be used.

**Note:** The clock / calendar chip in the 1812 Classic will keep time for approximately 48 hours if power to the system is lost or removed. If power is off longer than this, the clock / calendar chip will have to be reprogrammed.

1. Press \* 3 3 and enter the MASTER CODE. [**\* 3 3** \_ \_ \_ \_ (beep)]
2. Enter the current hour (01 to 12) and minutes (01 to 59), then press \*. [ \_ \_ \_ \_ **\*(beep)**  
Note: Do not use military (24 hour) time format
3. Press 0 \* for AM **OR** press 1 \* for PM. [ \_ **\*(beep)**
4. Enter the month (01 to 12), day of the month (01 to 31), the year (00 to 99), day of the week (See example below) then press \*. [ \_ \_ \_ \_ \_ \_ \_ **\*(beeeeeep)**  
Note: Days of the week are Sun =1, Mon = 2, Tue = 3, Wed = 4, Thu = 5, Fri = 6, Sat = 7.

**Example:** Saturday, February 12th, 2011, 11:30 AM.

Your Master Code - **1. \* 3 3** \_ \_ \_ \_ (beep)

Time - **2. 1 1 3 0** **\*(beep)**

AM - **3. 0** **\*(beep)**

Month, Day, Year, Day of the Week - **4. 0 2 1 2 1 1 7** **\*(beeeeeep)**

### 2.4.2 Do Not Disturb Time Zone Programming

The Do Not Disturb (DND) feature allows the resident to program a schedule when they do not want the 1812 to ring the house phones or to call forward when the call button on the unit is pressed. For example, a resident may program a do not disturb schedule from 10 PM to 7 AM on certain days of the week, or all seven days. Once the DND schedule has been programmed, it **MUST** still be enabled or disabled as desired (See 4.7).

1. Press \* 3 4 and enter the MASTER CODE. [**\* 3 4** \_ \_ \_ \_ (beep)]
2. Press 0 \* to turn DND OFF, **OR** press 1 \* to turn DND ON. [ \_ **\*(beep)**
3. Enter the beginning hour (01 to 12) and minutes (01 to 59), then press 0\* for AM **OR** press 1 \* for PM. [ \_ \_ \_ \_ then \_ **\*(beep)**
4. Enter the ending hour (01 to 12) and minutes (01 to 59), then press 0\* for AM **OR** press 1 \* for PM. [ \_ \_ \_ \_ then \_ **\*(beep)**
5. Enter the days of the week that the DND is to be active, then press \*. [ \_ \_ \_ \_ \_ \_ \_ **\*(beep)**  
Sun =1, Mon = 2, Tue = 3, Wed = 4, Thu = 5, Fri = 6, Sat = 7.  
Note: All 7 programming spaces must be populated. After all the desired day numbers have been entered, enter # in all the existing unused spaces.  
For example, for the DND to be active monday through friday only, enter 2 3 4 5 6 # # \*.
6. Press 0 # TOGETHER to end. [**0 #** (beeeeeep)]

## 2.4.3 Automatic Relay Activation Time Zones Programming

---

This program sequence sets up time zones to automatically activate and deactivate the relays on the control board. Each relay can be programmed with two independent time zones. Time zones 1 and 2 affect relay 1 operation; time zones 3 and 4 affect relay 2 operation. These time zones MUST still be independently enabled or disabled after they have programmed (See 4.9).

1. Press \* 3 5 and enter the MASTER CODE. [**\* 3 5** \_ \_ \_ \_ (beep)]
2. Enter a time zone number (1 or 2 for relay 1, 3 or 4 for relay 2), then press \*. [**\_ \***(beep)]
3. Press 0 \* to turn time zone OFF, **OR** press 1 \* to turn time zone ON. [**\_ \***(beep)]
4. Enter the beginning hour (01 to 12) and minutes (01 to 59), then press 0\* for AM **OR** press 1 \* for PM. [ \_ \_ \_ \_ then **\_ \***(beep)]
5. Enter the ending hour (01 to 12) and minutes (01 to 59), then press 0\* for AM **OR** press 1 \* for PM. [ \_ \_ \_ \_ then **\_ \***(beep)]
6. Enter the days of the week that a relay time zone is to be active, then press \*.  
[ \_ \_ \_ \_ \_ \_ \_ \* (beep)]  
Sun = 1, Mon = 2, Tue = 3, Wed = 4, Thu = 5, Fri = 6, Sat = 7.  
Note: All 7 programming spaces must be populated. After all the desired day numbers have been entered, enter # in all the existing unused spaces.  
For example, for a relay to be active monday through friday only, enter 2 3 4 5 6 # # \*.
7. Repeat steps 2 through 6 to program the other time zones (up to 4).
8. Press 0 # TOGETHER to end. [**0 # (beeeeeep)**]

## 2.4.4 Access Code Time Zone Programming

---

This programming sequence sets up a time zone for **ALL** four-digit access codes that have been programmed into the time zoned access code location areas. Access codes that are programmed into these location areas will not work outside of the programmed time zone. This time zone MUST still be enabled or disabled once it is programmed (See 4.8). See 2.6.1 to program access codes.

1. Press \* 3 6 and enter the MASTER CODE. [**\* 3 6** \_ \_ \_ \_ (beep)]
2. Press 0 \* to turn time zone OFF, **OR** press 1 \* to turn time zone ON. [**\_ \***(beep)]
3. Enter the beginning hour (01 to 12) and minutes (01 to 59), then press 0\* for AM **OR** press 1 \* for PM. [ \_ \_ \_ \_ then **\_ \***(beep)]
4. Enter the ending hour (01 to 12) and minutes (01 to 59), then press 0\* for AM **OR** press 1 \* for PM. [ \_ \_ \_ \_ then **\_ \***(beep)]
5. Enter the days of the week that the access code time zone is to be active, then press \*.  
[ \_ \_ \_ \_ \_ \_ \_ \* (beep)]  
Sun = 1, Mon = 2, Tue = 3, Wed = 4, Thu = 5, Fri = 6, Sat = 7.  
Note: All 7 programming spaces must be populated. After all the desired day numbers have been entered, enter # in all the existing unused spaces.  
For example, for the access codes to be active monday through friday only, enter 2 3 4 5 6 # # \*.
6. Press 0 # TOGETHER to end. [**0 # (beeeeeep)**]

## 2.4.5 Call Forward Time Zone Programming

This programming sequence sets up a time zone for the call-forward feature. The 1812 must also have a call forward phone number programmed into the 1812 memory (2.5.1). The call forward feature must be **disabled** (2.5.2) and the call forward time zone feature must be **enabled** (4.6). It will automatically send calls to the forwarding phone number if the time and day are within the time zone boundary that is programmed in this sequence. This feature is also dependent on the time and day being outside the Do Not Disturb time zone boundary (2.4.2), if that has been programmed and enabled (4.7).

1. Press \* 3 7 and enter the MASTER CODE. [**\* 3 7** \_ \_ \_ \_ (beep)]
2. Press 0 \* to turn time zone OFF, **OR** press 1 \* to turn time zone ON. [ \_ \*(beep)]
3. Enter the beginning hour (01 to 12) and minutes (01 to 59), then press 0\* for AM **OR** press 1 \* for PM. [ \_ \_ \_ \_ then \_ \*(beep)]
4. Enter the ending hour (01 to 12) and minutes (01 to 59), then press 0\* for AM **OR** press 1 \* for PM. [ \_ \_ \_ \_ then \_ \*(beep)]
5. Enter the days of the week that the call forward time zone is to be active, then press \*.  
[ \_ \_ \_ \_ \_ \_ \_ \*(beep)]  
Sun = 1, Mon = 2, Tue = 3, Wed = 4, Thu = 5, Fri = 6, Sat = 7.  
Note: All 7 programming spaces must be populated. After all the desired day numbers have been entered, enter # in all the existing unused spaces.  
For example, for the call forward to be active monday through friday only, enter 2 3 4 5 6 # # \*.
6. Press 0 # TOGETHER to end. [**0 # (beeeeeep)**]

## 2.4.6 “Flash” Access Code Time Zone Programming (One Day Only)

“Flash” codes are access codes that are valid for a **single day ONLY**. Programming “flash” codes is a two-step process. This programming sequence only schedules the day of the month that the “flash” access codes will be valid. Section 2.6.1 must still be programmed to enter the four-digit “flash” access codes. There is one “flash” access code per relay (2 total).

1. Press \* 4 5 and enter the MASTER CODE. [**\* 4 5** \_ \_ \_ \_ (beep)]
2. Press 1 for relay 1 **OR** press 2 for relay 2, then press \*. [ \_ \*(beep)]
3. Enter the two-digit day of the month that the “flash” code is to be valid, then press \*. [ \_ \_ \*(beep)]
4. Repeat steps 2 and 3 to set the other relay “flash” code if necessary.
5. Press 0 # TOGETHER to end. [**0 # (beeeeeep)**]

Note: The “flash” code will be valid for a **single day only**. For example, if you program a “flash” code on July 1st to be valid on July 10th, the code will become valid on midnight July 10th, and expire on midnight July 11th. The “flash” code **will NOT** become valid again on August 10th of the following month. For the existing “flash” code to function again, it **MUST** be **reprogrammed** using the 5 steps above for a new valid day.

## 2.5 Programming Dial-Out Functions

### 2.5.1 Call Forward Phone Number Programming

These steps program the call forwarding telephone number into the 1812 memory. Call forwarding can **only** be used when the 1812 is programmed in **phone mode** (see 2.3.1). To Enable/Disable call forward see 2.5.2 below. The call forward phone number can also be set up for a time zone activation (2.4.5).

1. Press \* 1 0 and enter the MASTER CODE. [**\* 1 0** \_ \_ \_ \_ (beep)]
2. If the forwarding phone number is **11 digits**:  
Press 1 then enter the area code, then press \*. [ **1** \_ \_ \_ \* (beep)]  
If the forwarding phone number is **10 digits**:  
Press # then enter the area code, then press \*. [ **#** \_ \_ \_ \* (beep)]  
If the forwarding phone number is **7 digits**:  
Press # # # #, then press \*. [ **# # # #** \* (beep)]
3. Enter the seven-digit phone number, then press \*. [ \_ \_ \_ \_ \_ \_ \_ \* (beep)]  
Note: 7 digits, no dashes.
4. Press 0 # TOGETHER to end. [**0 #** (beeeeeep)]

### 2.5.2 Call Forward - Enable / Disable

This programming sequence Enables/Disables the call forward feature. You must have a call forward phone number programmed into the 1812 memory (See 2.5.1 above). Call forward can **only** be used when the 1812 is programmed in **phone mode** (see 2.3.1). Call forward **MUST** be **disabled** if you are going to use a call forward time zone activation (2.4.5).

1. Press \* 1 4 and enter the MASTER CODE. [**\* 1 4** \_ \_ \_ \_ (beep)]
2. Press 0 \* to disable call forward, **OR** press 1 \* to enable call forward. [ \_ \* (beep)]
3. Press 0 # TOGETHER to end. [**0 #** (beeeeeep)]

### 2.5.3 Preprogrammed Phone Numbers “Dial a Phone Number”

The 1812 has the capability of operating as an auto-dialer system and can store up to 3 phone numbers in its memory. When a visitor enters a “Directory number” 01, 02, or 03 on the system keypad, the 1812 will call the preprogrammed phone number programmed for that specific directory number. This feature can **only** be used when the 1812 is programmed in **phone mode** (see 2.3.1).

Note: These phone numbers function differently than the call forward phone number that was programmed in 2.5.1.

**To program the phone number that will be called when “01” is pressed on the system keypad:**

1. Press \* 2 1 (See note below) and enter the MASTER CODE. [**\* 2 1** \_ \_ \_ \_ (beep)]
2. If the phone number is **11 digits**:  
Press 1 then enter the area code, then press \*. [ **1** \_ \_ \_ \* (beep)]  
If the phone number is **10 digits**:  
Press # then enter the area code, then press \*. [ **#** \_ \_ \_ \* (beep)]  
If the phone number is **7 digits**:  
Press # # # #, then press \*. [ **# # # #** \* (beep)]
3. Enter the seven-digit phone number, then press \*. [ \_ \_ \_ \_ \_ \_ \_ \* (beep)]  
Note: 7 digits, no dashes.
4. Press 0 # TOGETHER to end. [**0 #** (beeeeeep)]

**Note:**

Press \* 2 2 in step 1 to program the phone number called when “02” is pressed on the system keypad.

Press \* 2 3 in step 1 to program the phone number called when “03” is pressed on the system keypad.

## 2.6 Access Codes to Operate Access Control Devices

### 2.6.1 Access Code Programming

This programming sequence programs four-digit “Access Codes” into the system memory. The access codes will operate either relay 1 or relay 2 with a specific function depending on the “location code” number that is choose from the table below for every access code programmed. You can store up to 50 unique access codes into the system memory. We recommend that you keep a log of all programmed access codes in the log sheet in back of this manual.

**Each** relay can have (See table below):

- 14 momentary activation codes - Relay will activate for its programmed relay strike time (2.3.4).
- 1 flash code - Flash code time zone must be programmed (2.4.6).
- 5 hold codes - Automatic relay activation time zone(s) must be programmed (2.4.3) and enabled (4.9).
- 5 time zone codes - Access code time zone(s) must be programmed (2.4.4) and enabled (4.8).

1. Press \* 0 2 and enter the MASTER CODE. [**\* 0 2 \_ \_ \_ \_ (beep)**]
2. Enter the two-digit “location code” (See table below), then press \*. [**\_ \_ \*(beep)**]
3. Choose and enter a four-digit access code, then press \*. [**\_ \_ \_ \_ \*(beep)**]
4. Repeat steps 2 and 3 to enter additional access codes.
5. Press 0 # TOGETHER to end. [**0 # (beeeeeep)**]

Relay 1		Relay 2	
Location Code (Step 2)	Function	Location Code (Step 2)	Function
01 - 14	Momentary Activation	26 - 39	Momentary Activation
15	Flash	40	Flash
16 - 20	Hold	41 - 45	Hold
21 - 25	Time Zone	46 - 50	Time Zone

**External time clock note** (wired to terminal 6 and 9): When this input is activated, access codes that have been programmed into the “Time Zone” location codes will not work (Refer to 1.11 and 4.14).

### 2.6.2 Delete an Access Code

This programming sequence deletes individual existing access codes that have been programmed into the system.

1. Press \* 0 2 and enter the MASTER CODE. [**\* 0 2 \_ \_ \_ \_ (beep)**]
2. Enter the two-digit “location code” (See table above), then press \*. [**\_ \_ \*(beep)**]
3. Enter # # # #, then press \*. [**# # # # \*(beep)**]
4. Repeat steps 2 and 3 to delete additional existing access codes.
5. Press 0 # TOGETHER to end. [**0 # (beeeeeep)**]

### 2.6.3 Delete All Access Codes

This programming sequence deletes **ALL** existing access codes that have been programmed into the system.

**WARNING: Once started, all access codes will be erased and cannot be retrieved.**

1. Press \* 0 0 and enter the MASTER CODE. [**\* 0 0 \_ \_ \_ \_ (beep)**]
2. Press 9 9 9 9, then press \*. [**9 9 9 9 \*(beep)**]
3. The programming sequence will end itself automatically. [**beeeeeep**]



# SECTION 3 - ADJUSTMENTS

## Speaker Volume

The speaker volume potentiometer is labeled SPEAKER VOL on the control board. The speaker volume should be adjusted for adequate sound. Adjusting the speaker volume too loud could cause feedback from the microphone.

1. Open the front of the telephone entry system and locate the speaker volume adjustment.
2. Push the "Push To Call" button to place a call to the resident. While they are talking, adjust the speaker volume potentiometer for adequate sound. To increase the volume rotate the potentiometer clockwise, to decrease the volume rotate the potentiometer counter clockwise.

## Feedback 1

The feedback 1 potentiometer is labeled FB1 on the control board. This adjustment minimizes feedback from the microphone to the speaker when the system is connected to the resident telephone.

1. Open the front of the telephone entry system and locate the Feedback 1 adjustment.
2. Push the "Push To Call" button to place a call to the resident. After they answer, ask the resident to remain silent.
3. While rubbing your finger across the microphone hole, rotate the feedback potentiometer clockwise, and then counter clockwise. When the noise from the speaker is minimum, this is the correct adjustment for the feedback potentiometer.

## Feedback 2

The feedback 2 potentiometer is labeled FB2 on the control board. This adjustment minimizes feedback from the microphone to the speaker when the system has placed a call to an outside phone line. Note: Feedback 2 is not used when the 1812 is programmed in the **intercom mode**.

1. Open the front of the telephone entry system and locate the Feedback 2 adjustment.
2. Enter one of the preprogrammed phone number directory codes (01, 02, 03) on the system keypad to place a call to an outside number (see 2.5.3 to program an outside number). After the party answers, ask them to remain silent.
3. While rubbing your finger across the microphone hole, rotate the feedback potentiometer clockwise, and then counter clockwise. When the noise from the speaker is minimum, this is the correct adjustment for the feedback potentiometer.

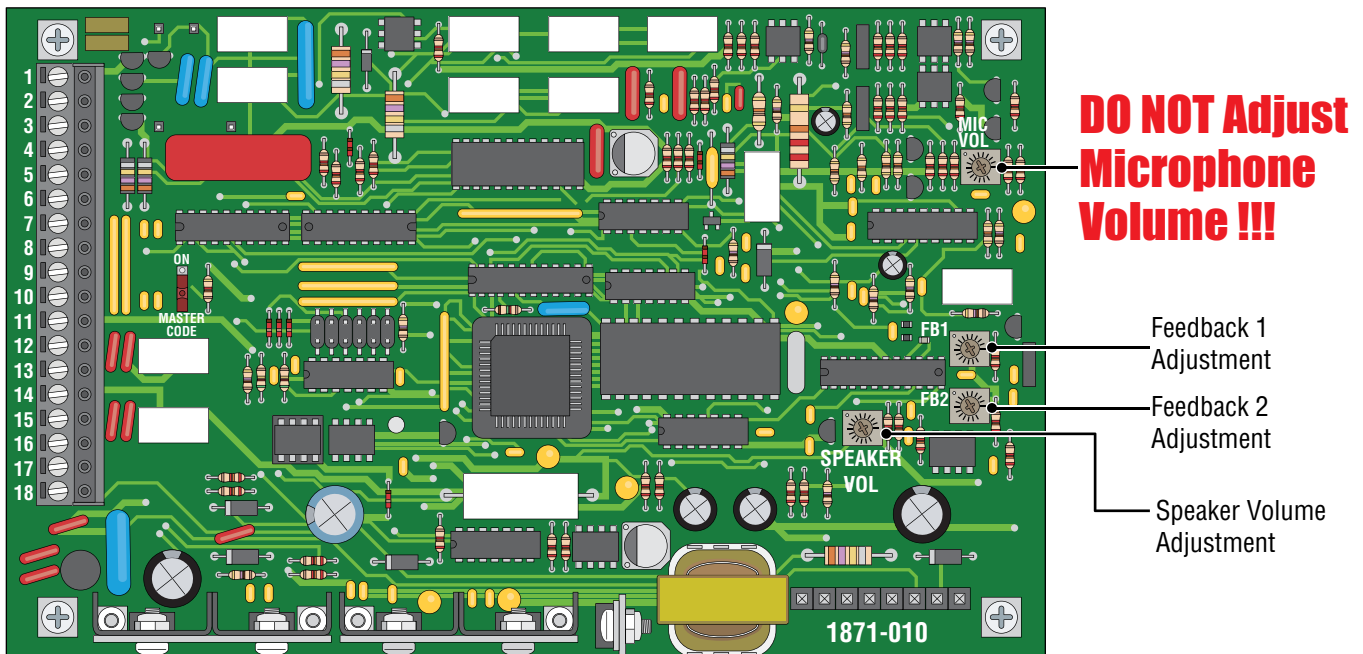

## System Keypad

Used to key in existing Access Codes and Preprogrammed Phone Numbers - Directory Numbers during normal operation. Also used to program the system features.



## Push To Call Button

Places a call from the 1812 to the homeowner's phone.

## SECTION 4 - OPERATING INSTRUCTIONS

### 4.1 Calling the Homeowner's Phone from the 1812

To place a call from the 1812 to the homeowner's house, the guest simply presses the PUSH TO CALL button located on the faceplate, see previous page. Once the guest has been identified by voice communication, the homeowner may grant them access by pressing the appropriate tone open number, or they may deny access by simply hanging up or dialing 7 for relay 1, see below.

1. To grant access to a guest, press the programmed tone open number. (The factory setting for relay 1's tone open number is 9, however this can be programmed to any number desired. See section 2.3.5 to program tone open numbers.) The 1812 will respond with a confirming tone and will open the door or gate connected to relay 1.
2. To deny access, hang up the telephone. (Dial 7 for wireless adapter only, see section 2.3.5 and the wireless manual for more information).

Prior to ringing the homeowner's phone, the 1812 will perform several logic steps to check the status of the Do Not Disturb (DND) and Call Forward features. If the DND feature is **enabled**, the DND time zone will be checked. If the time is within the DND time zone boundary, the system will not ring the homeowner's phone and will not call forward, even if the call forward feature is **enabled**. If the DND feature is **enabled** but the time is outside the DND time zone, the system will then check the call forward function. If the DND feature is **disabled**, the system will check the call forward function.

If the call forward feature is enabled, the 1812 will automatically dial out the preprogrammed call forward phone number when the guest pushes the Push To Call button regardless if the call forward time zone is enabled or disabled. If the call forward feature is **disabled**, the system will then check the call forward time zone. If the call forward time zone is **enabled** and the time is within the call forward time zone boundaries, the system will dial the preprogrammed call forward phone number. If the call forward time zone is **enabled** and the time is outside the call forward time zone boundaries, the system will ring the homeowner's phone. If the call forward time zone is **disabled**, the system will ring the homeowner's phone.

### 4.2 Call Waiting

When the homeowner is on their telephone and a guest pushes the Push To Call push button, the 1812 will sound a short tone in the homeowner's handset. This indicates to the homeowner that a guest is at their door or gate.

1. To place the outside call on HOLD and talk to the guest, press #.  
This will connect the homeowner's telephone with the 1812.
  - A. To **GRANT the guest access**, press the programmed tone open number (2.3.5).  
The 1812 will respond with a confirming tone, open the door or gate, and will reconnect the homeowner's phone with their outside call.
  - B. To **DENY the guest access**, press #.  
The 1812 will disconnect from the homeowner's phone and reconnect it to the outside call.

The same process can be used when the homeowner is talking to a guest **AT** the 1812 and an outside call comes in. The homeowner can place the guest on hold and switch to the outside call.

### 4.3 Preprogrammed Phone Numbers

To use the preprogrammed phone number feature, the guest simply presses 01, 02, or 03 on the system keypad. The 1812 will automatically dial out the specific preprogrammed phone number. Once the call is answered at the other end, that party may grant or deny a guest access by pressing the programmed tone open number or simply hanging up.

Note: These phone numbers function differently than the call forward phone number.

- To call the first preprogrammed number, press "**01**" on the system keypad.
- To call the second preprogrammed number, press "**02**" on the system keypad.
- To call the third preprogrammed number, press "**03**" on the system keypad.

## 4.4 Access Codes

The access codes will operate either relay 1 or relay 2 with a specific function depending on the “location code” number that is chosen from the table in section 2.6.1 for every access code programmed.

1. Press #.
2. Enter four-digit access code.

When the access code is entered on the system keypad, the system will check its memory to see if the code entered is stored and under which location code it has been stored. If the access code is stored under a momentary activation location code, either relay 1 or relay 2 will activate for the programmed relay strike time depending on which location code the access code was programmed for. If the access code is stored under a hold location code, the specific relay will latch on until another access code is entered on the system keypad.

If the access code entered is programmed for a “time zone” location code, the system will first check to see if the access code time zone is enabled or disabled. If this time zone is **disabled**, the access code will activate the specific relay for the programmed relay strike time. If the access code time zone is **enabled**, the system will check the clock to determine if the access code is within the time zone boundary. If the access code is within the time zone boundary, the respective relay will activate for the programmed relay strike time. If the access code is outside of the time zone boundary, the relay will **NOT** activate.

If the access code is programmed for a “flash” location code, the system will check the clock to determine if the current day is the programmed operating day for the access code. If the current day is valid, the respective relay will operate for the programmed relay strike time. If the current day is not valid, the relay will not operate. Once the programmed operating day is past, the flash access code will not work unless a new flash operating day is programmed into the system (2.4.6).

## Homeowner Programming Instructions (From Home Phone or 1812)

When the following programming features are going to be enabled and disabled from the homeowner's touch-tone telephone:

- The 1812 MUST be programmed to “Answer incoming call on X rings” (2.3.6). Factory setting - 6 rings.
- The 1812 MUST be programmed to “Answer incoming call - enabled” (2.3.7). Factory setting - enabled.
- The system “attention number” factory setting - 7.  
If the system “attention number” has been reprogrammed in section 2.3.2, use the new attention number in step 1.

The following features can also be programmed at the **1812 system keypad** by skipping step 1, start with step 2 and press 0 # together instead of hanging up the phone in step 4.

## 4.5 Call Forward - Enable / Disable

To use the call forward feature, be sure that a call forward phone number has been programmed into the system memory (2.5.1). This operating step enables or disables the call forward feature. If this feature is enabled, all calls from the 1812 will be forwarded regardless of whether the call forward time zone is enabled or disabled. If the call forward feature is set up for a time zone, call forward MUST be disabled.

1. Pick up homeowner's telephone and press \* 7. [**\* 7 (beep)**]
2. Press \* 1 4 and enter the MASTER CODE. [**\* 1 4 \_ \_ \_ \_ (beep)**]
3. Press 1 \* to enable call forward, **OR** press 0 \* to disable call forward. [**\_ \* (beep)**]
4. Hang up.

## 4.6 Call Forward Time Zone - Enable / Disable

To use the call forward time zone feature, be sure that a call forward time zone has been programmed into the system (2.4.5), call forward phone number is programmed (2.5.1) and that the call forward is disabled (2.5.2). This will cause the 1812 to check the time zone before forwarding any calls to the forward phone number.

1. Pick up homeowner's telephone and press \* 7. [**\* 7 (beep)**]
2. Press \* 3 7 and enter the MASTER CODE. [**\* 3 7 \_ \_ \_ \_ (beep)**]
3. Press 1 \* to enable call forward time zone, **OR** press 0 \* to disable call forward time zone. [**\_ \*(beep)**]
4. Hang up.

## 4.7 Do Not Disturb - Enable / Disable

To use the Do Not Disturb feature, be sure that a do not disturb time zone has been programmed into the system memory (2.4.2). When the do not disturb feature is enabled and it's time zone is active, the 1812 will not allow calls to the house or allow calls to be forwarded to the house, regardless of whether the call forward feature is enabled or disabled.

1. Pick up homeowner's telephone and press \* 7. [**\* 7 (beep)**]
2. Press \* 3 4 and enter the MASTER CODE. [**\* 3 4 \_ \_ \_ \_ (beep)**]
3. Press 1 \* to enable do not disturb time zone, **OR** press 0 \* to disable do not disturb time zone. [**\_ \*(beep)**]
4. Hang up.

## 4.8 Access Code Time Zone - Enable / Disable

The access code time zone affects only those access codes programmed under the "time zone" access code "location codes" 21-25 for relay 1, 46-50 for relay 2. To use this feature, be sure that four-digit access codes have been programmed into the system under the desired location codes, and be sure that an access code time zone has been programmed (2.4.4).

1. Pick up homeowner's telephone and press \* 7. [**\* 7 (beep)**]
2. Press \* 3 6 and enter the MASTER CODE. [**\* 3 6 \_ \_ \_ \_ (beep)**]
3. Press 1 \* to enable access code time zone, **OR** press 0 \* to disable access code time zone. [**\_ \*(beep)**]
4. Hang up.

## 4.9 Auto Relay Activation Time Zones - Enable / Disable

The four automatic relay activation time zones can be enabled or disabled as required. Time zones one and two operate relay 1, while time zones three and four operate relay 2. To use this feature, be sure that the automatic relay activation time zones have been programmed (2.4.3).

1. Pick up homeowner's telephone and press \* 7. [**\* 7 (beep)**]
2. Press \* 3 5 and enter the MASTER CODE. [**\* 3 5 \_ \_ \_ \_ (beep)**]
3. Enter the automatic relay activation time zone number (1-4), then press \*. [**\_ \*(beep)**]
4. Press 1 \* to enable relay activation time zone, **OR** press 0 \* to disable relay activation time zone. [**\_ \*(beep)**]
5. Hang up.

## 4.10 Answer Incoming Call - Enable / Disable Only from Phone

The auto answer feature must be enabled to allow relay activation and programming of the system from a remote location. When the homeowners phone number is called, the 1812 will pick up the call after the programmed number of rings (2.3.6).

Note: You can only disable this feature from the homeowner's phone. It can only be enabled from the system keypad.

1. Pick up homeowner's telephone and press \* 7. [**\* 7 (beep)**]
2. Press \* 1 5 and enter the MASTER CODE. [**\* 1 5 \_ \_ \_ \_ (beep)**]
3. Press 1 \* to enable incoming call, **OR** press 0 \* to disable incoming call. [**\_ \*(beep)**]
4. Hang up.

## 4.11 Relay Activation Check

The 1812 can be called to check if relay 1, relay 2, or both relays in the system are latched and holding a door or gate in the open (unlocked) position.

1. Pick up homeowner's telephone and press \* 7. [ \* 7 (beep)]
2. Listen for the following sequence of tones:  
**No Tones:** neither relay is activated.  
**Relay 1 Activated:** beep - pause - beep - pause . . .  
**Relay 2 Activated:** beep beep - pause - beep beep - pause . . .  
**Both Relays Activated:** beep beep beep - pause - beep beep beep - pause . . .
3. Hang up.

## 4.12 Remote Programming

The 1812 can be programmed and operated from a remote location (Home or off-site) using a touch-tone telephone. Be sure that the programming for the 1812 to "Answer incoming call" has not been disabled (2.3.7).

Note: The 1812 master code cannot be programmed remotely – it can only be programmed from the system keypad – see Programming the Master Code on page 20.

1. Call the homeowner's phone number. After the programmed number of rings (2.3.6) the 1812 will answer with a tone.
2. Follow the desired programming steps in the Programming Sections of this manual.
3. When complete with the desired programming function, hang up. You cannot use 0# pressed together to end programming steps from a touch-tone telephone. Wait 30 seconds before calling back to program another feature.

## 4.13 Remote Relay Activation

The 1812 system relays can be activated from the home phone or from a remote (off-site) location. The answer incoming call feature must be enabled (2.3.7) to activate any of the relays from a remote location. Refer to the tone open numbers that were programmed in section 2.3.5 to determine each of the relay activation functions. Only one tone open number will function per phone call. E.g.: If you call and want to "Hold Open" the relay, you will have to call back to "Deactivate" it later.

- **Momentary Activation** (Relay activates for its programmed strike time).
- **Hold Open** (Relay will activate and remain activated).
- **Deactivate** (Relay will deactivate).
- **Hold 1 Hour** (Relay will activate for 1 hour and then automatically deactivate).

To activate the relay(s) from the homeowner's house, perform the following steps:

1. Pick up homeowner's telephone and press \* 7. [ \* 7 (beep)]
2. Enter the desired tone open number (2.3.5). [ \_ (beep)]
3. 1812 will automatically hang up.

To activate the relay(s) from a remote (off-site) location, perform the following steps.

1. Call the homeowner's phone number. After the programmed number of rings (2.3.6) the 1812 will answer with a tone.
2. Press \* 1 6 and enter the MASTER CODE. [ \* 1 6 \_ \_ \_ \_ (beep)]  
(Two-way voice communication is also enabled at this point)
3. Enter the desired tone open number. [ \_ (beep)]
4. 1812 will automatically hang up.

## 4.14 Switch Input Operation (Terminals 6, 7, 8 & 9)

A switch closure between terminals 7 and 9 will activate relay 1 for its programmed relay strike time (2.3.4). A switch closure between terminals 8 and 9 will activate relay 2 for its programmed relay strike time (2.3.4).

A switch closure between terminals 6 and 9 will activate the external time zone input. When this input is activated, access codes that have been programmed into the time zone restricted "location codes" will not work (2.6.1).

The 1812 has two time zones available as a built-in programming function. The external time clock input provides a method to activate a third time zone, but requires an external time clock to be wired to terminals 6 and 9 (1.11).

## SECTION 5 - MAINTENANCE

The DoorKing 1812 telephone entry system is essentially a maintenance free device. When the unit is properly installed, it should provide years of trouble free service. Maintenance is limited to updating the access codes on an as needed basis.

The faceplate of the unit should be cleaned on a regular basis to keep contaminants in the air from sticking to the surface and possibly causing pitting. When cleaning the faceplate of the system, never use an abrasive cleaner or cloth. Stainless steel cleaner works very well with a soft cloth for systems with a stainless steel faceplate. A clean damp soft cloth should be used to clean gold plated faceplates.

### 5.1 Troubleshooting

If problems should develop with your telephone entry system, refer to 5.4 troubleshooting table on pages 37 and 38 to try and correct any problems. Our experience has shown that a majority of reported problems are actually programming related and can be corrected on site. If problems persist and they cannot be corrected, contact your authorized DoorKing dealer for assistance. Before performing any troubleshooting, check the following:

1. Have a good VOM meter handy to check voltages and continuity.
2. Have a telephone test set (DoorKing P/N 1800-050 or equivalent) to check the telephone line. Noise on the phone line will cause problems with the entry system.
3. Check the polarity of the phone lines. See section 5.3 on the next page.
4. Be sure that the entry system case is properly grounded.
5. Be sure that the telephone wires are twisted.
6. A hum on the system indicates that the phone line or 24 VAC power lines may be grounded. Check to be sure that the phone lines or power lines are not shorted to ground. Be sure that the cable used for communication is a twisted pair, good quality phone cable insulated for direct underground burial. **Using phone wire that is designed for indoor use only can absorb moisture and cause a hum on your phone line.**
7. Check the 24 VAC system power. Be sure that the transformer is properly rated (20 VA). Keep the wire run from the transformer to the entry system as short as possible. Use 16 or 18 AWG, 600 volt insulated wire only. **The importance of proper power wiring cannot be over stressed!**

### 5.2 1812 Classic Wiring Schematic

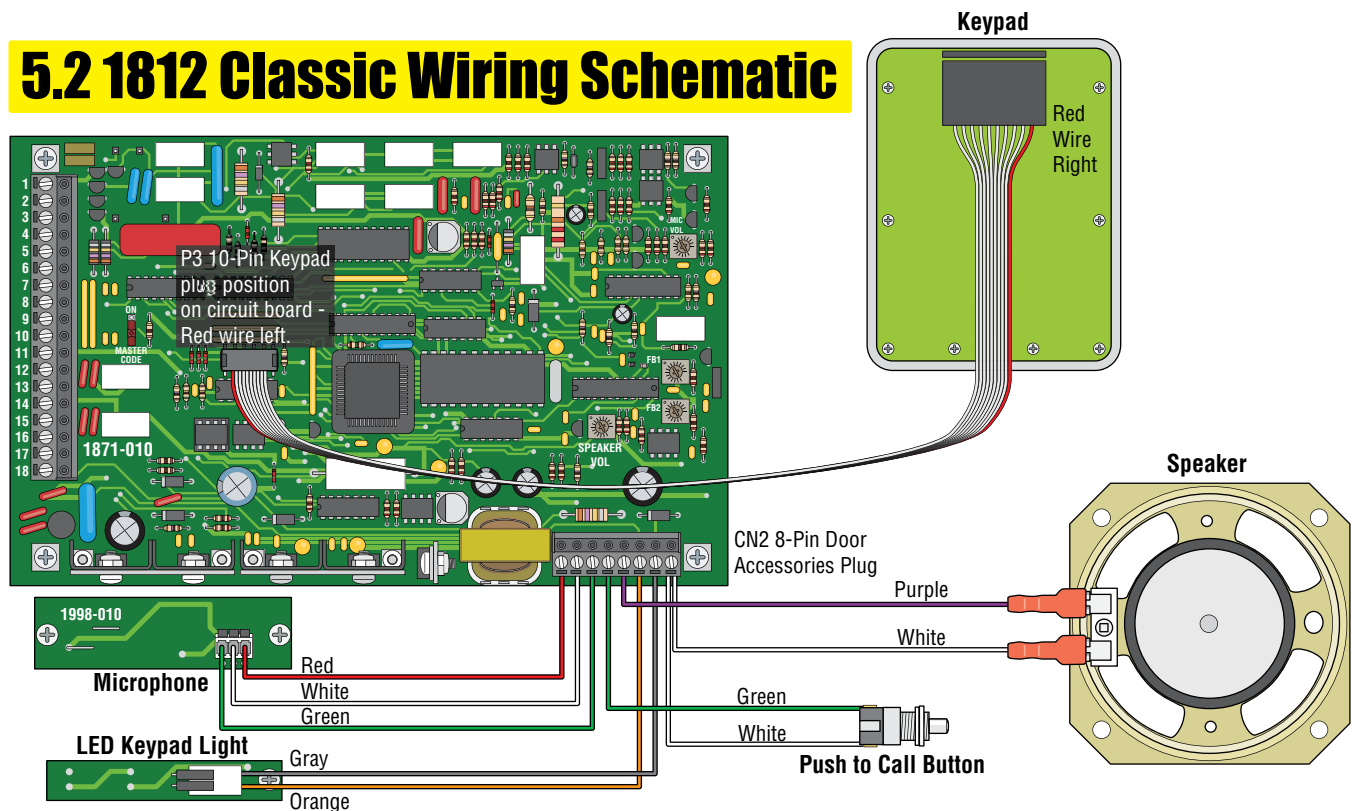

# 5.3 Phone Line Polarity

When troubleshooting 1812 operational problems, check phone line polarity. **Crossed polarities can affect system operation.**

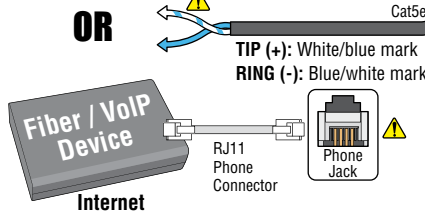
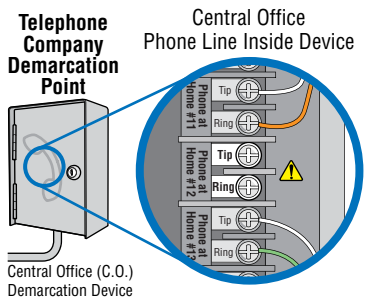
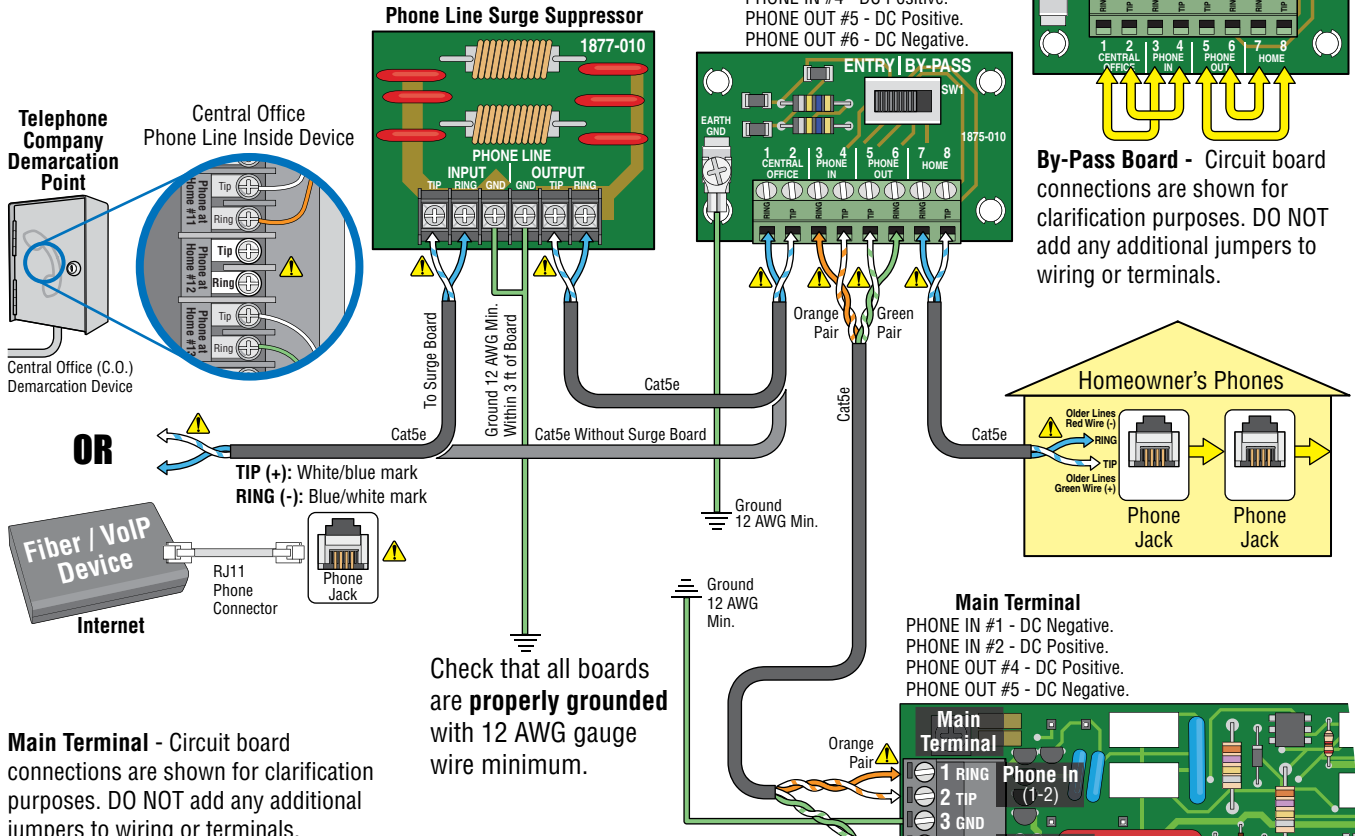

**Main Terminal** - Circuit board connections are shown for clarification purposes. **DO NOT** add any additional jumpers to wiring or terminals.

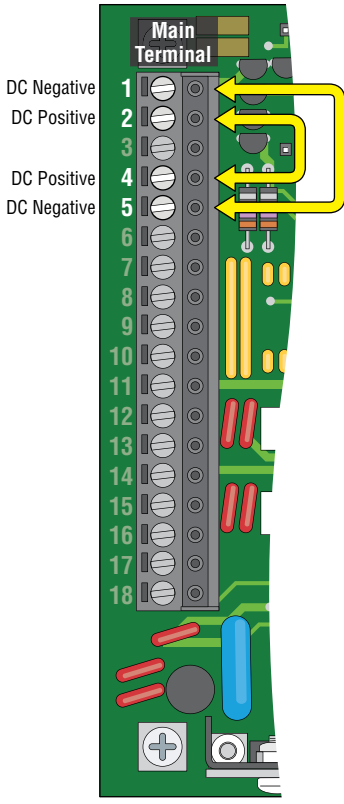

**⚠ Check Polarity on Terminals**  
Example: set a VOM meter to measure DC volts. Place the positive lead on 1812 terminal 2 and the negative lead on 1812 terminal 1. **If the meter shows a positive voltage - OK.** If the meter shows a negative voltage (needle moves off scale to the left), reverse the wires. Repeat this process to check other wire pairs on bypass board and 1812 main terminal.

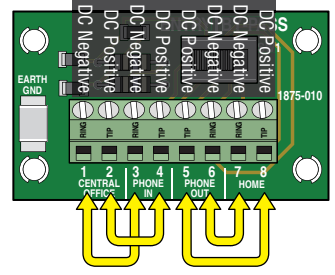

**By-Pass Board** - Circuit board connections are shown for clarification purposes. **DO NOT** add any additional jumpers to wiring or terminals.

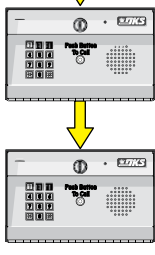
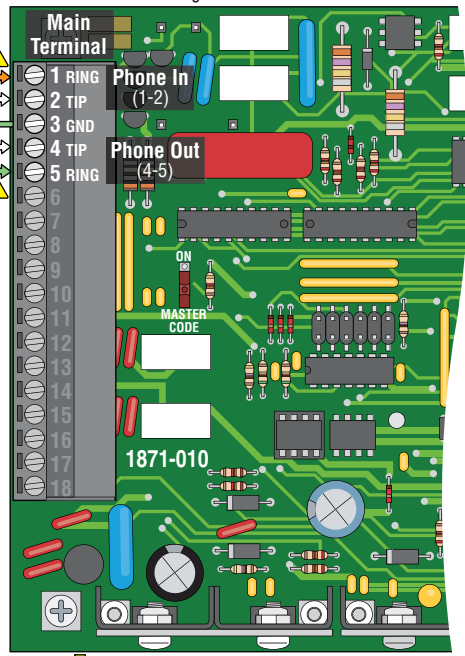
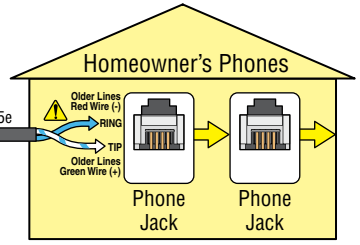

**⚠ When multiple 1812 systems are connected together, maintain common polarity on ALL phone lines.**

## 5.4 Isolating Noise Problems

If noise or hum is present on the homeowner's phone line after installation of the 1812 telephone intercom system, use the procedure on the next page to find and correct the source of the noise. This procedure will require the use of a telephone test set (DoorKing P/N 1800-050 or equivalent). Typically, noise is usually introduced into the system because of incorrect wiring, poor quality of wire, wire runs exceeding maximum distances, phone and high voltage power wires running in the same conduit or in very close proximity to each other, a wrong type transformer was substituted, or the phone lines, power lines or 1812 circuit board is grounded.

1. Place the BYPASS switch in the BYPASS mode (slide switch to right). If noise goes away, problem is with phone in/out wiring, power wiring, or 1812 unit. Place the BYPASS switch in the ENTRY SYSTEM mode (slide switch to left) and proceed to step 3. If noise is still present when switch is in the bypass mode, disconnect C.O. wires and HOUSE wires from bypass switch. Connect the C.O. wires to the HOUSE wires. If the noise goes away, the bypass switch is bad and needs to be replaced. If noise is still present, contact the telephone company for service.
2. Remove all external items connected to the 1812 unit, such as back-up batteries, relay connections, push button switches, or time clocks. All terminals should be free of any wiring except terminals 1 and 2 (PHONE IN WIRES), terminal 3 (CASE GROUND WIRE), terminals 4 and 5 (PHONE OUT WIRES), and terminals 17 and 18 (16.5 VAC POWER WIRES). If noise is still present, proceed to step 3. If noise is gone, the source of the noise is one of the external devices that were connected to the 1812. Reconnect them one at a time until you find the item that is the source of the noise.
3. Remove the PHONE OUT wires from terminals 4 and 5 at the 1812 unit. Connect your handy phone directly to the loose PHONE OUT wires. The wires should be dead and you should not have any dial tone on these wires. If you do have dial tone, the 1812 is wired incorrectly. Disconnect power immediately and refer to the wiring information section in this manual.
4. Disconnect your handy phone from the PHONE OUT wires (step 3). Remove the PHONE IN wires from terminals 1 and 2 at the 1812 unit. Connect the PHONE IN wires to the PHONE OUT wires. This completely disconnects the 1812 unit from the circuit. Check the phones in the house. If the noise is gone, problem is with or in the 1812 unit, or with the power supply or power wiring. Reconnect the PHONE IN wires to terminals 1 and 2, and the PHONE OUT wires to terminals 4 and 5, then proceed to step 5. If the noise is still present, problem is with the PHONE IN or PHONE OUT wires running from the 1812 unit to the bypass switch. These wires will need to be replaced and/or re-routed to correct the problem.
5. Disconnect the 24 VAC wires from terminals 17 and 18. If the phone line is now clear, the problem is in the 24 VAC power run. Check the power lines for a ground, or running next to high voltage wires, or an improper wire size and insulation, or too long of a wire run. If noise is still present, go to step 6.
6. If noise is still present at this step in the trouble shooting sequence, this would indicate a short to ground internally in the 1812 unit. Remove CN2 8-pin door accessories plug from the circuit board, and check for noise again. If noise is gone, this would indicate a problem with the microphone board, speaker, push button, or lights on the front panel assembly. Check for any shorts to ground on any of these components or wiring. Check to be sure that none of the wires are pinched. If noise is still present, check the wires entering the back of the 1812 box and be sure that none are pinched. Be sure that these wires are not touching the back of the 1812 circuit board, possibly causing a short to ground. If all of the above steps fail to identify the source of noise, contact DoorKing for additional assistance.

## 5.5 Troubleshooting Table

Symptom	Possible Solution(s)
Cannot get into programming mode.	<ul style="list-style-type: none"> <li>• Wrong master code entered. Start over.</li> <li>• Waiting too long between pushing buttons. Enter information quicker.</li> <li>• Keypad is not plugged into board correctly. Cable points down (Red wire on the left at circuit board).</li> </ul>
System emits a long tone and cancels programming.	<ul style="list-style-type: none"> <li>• Waiting too long between pushing buttons.</li> <li>• Forgetting to press * first when programming.</li> </ul>
Keypad is dead.	<ul style="list-style-type: none"> <li>• No power. Check for 24 VAC input power.</li> <li>• Check that the keypad is properly connected to the circuit board. The cable on the plug points down when connected to the circuit board.</li> </ul>
Dial tone is heard on the 1812 speaker.	<ul style="list-style-type: none"> <li>• The system is not wired in series with the resident phone line. Check the PHONE IN terminals (1 &amp; 2) and the PHONE OUT terminals (4 &amp; 5).</li> </ul>



Symptom	Possible Solution(s)
Buzz or noise on the line.	<ul style="list-style-type: none"> <li>• Check for a short to ground behind the circuit board.</li> <li>• Check for pinched wires near the door hinge.</li> <li>• Check for 24-volt power shorted to a conduit.</li> <li>• Check for a phone line shorted to ground.</li> <li>• Check that the phone wires are twisted.</li> <li>• Check that all wires, speaker, keypad, etc., are isolated from ground.</li> <li>• Check that the cabinet is properly grounded. Be sure case ground (terminal 3) is not used as a low voltage common.</li> <li>• Check for excessive voltage drop on 24 VAC power.</li> <li>• Check phone line with telephone test set.</li> </ul>
Buzz on telephone line.	<ul style="list-style-type: none"> <li>• Remove the PHONE IN and PHONE OUT wires from the 1812 terminal strip. Connect the PHONE IN wires to the PHONE OUT wires. If the noise is still present, bad PHONE IN or PHONE OUT wires.</li> <li>• Remove 24 VAC wires from the terminal strip. Check house phones. If noise goes away, 24 VAC wires are probably grounded. Replace wires.</li> <li>• Check internal wires, switch wires, battery wires for any pinches or shorts.</li> </ul>
Phones in home will not ring.	<ul style="list-style-type: none"> <li>• Check that the by-pass switch is not set to by-pass mode.</li> <li>• Do Not Disturb time zone may be enabled. Turn Do Not Disturb off or change time zone boundaries.</li> <li>• Call forwarding feature enabled or call forwarding time zone is turned on. Turn off call forwarding and call forwarding time zone. Change call forwarding time zone boundaries.</li> <li>• Voltage drop in 24 VAC supply. Check voltage at terminals 17 &amp; 18.</li> <li>• Disconnect PHONE OUT wires from terminals 4 &amp; 5. Connect test telephone to terminals 4 &amp; 5. If test telephone rings, problem is with phone out wiring. If test phone does not ring, circuit board may be at fault.</li> </ul>
Phones in home ring, but no communication occurs.	<ul style="list-style-type: none"> <li>• Check telephone company demarcation (interface) device placement. 1812 must be wired so that the C.O. wires exiting the demarcation device are connected to the C.O. terminals on the bypass switch. Check the wiring diagram.</li> <li>• Disconnect the PHONE OUT wires and connect a test telephone to the PHONE OUT terminals (4 &amp; 5). If the 1812 cannot communicate with the test phone, PHONE IN and PHONE OUT wires may be connected backwards. Check wiring and reconnect.</li> </ul>
System will not activate relays. Phones do not generate a tone.	<ul style="list-style-type: none"> <li>• Switch the wires on the PHONE OUT terminals (4 &amp; 5).</li> <li>• Switch wires on PHONE IN terminals (1 &amp; 2) if using the call forward or preprogrammed dialing out features.</li> <li>• Check for proper polarity throughout phone lines.</li> </ul>
System generates tone when granting access to a visitor, but will not work on regular phone line.	<ul style="list-style-type: none"> <li>• Switch the wires on the PHONE IN terminals.</li> </ul>
System will not answer when called from the homeowner's phone.	<ul style="list-style-type: none"> <li>• Using the wrong attention number. Re-program attention number (2.3.2).</li> </ul>
System will not answer when called from a remote location.	<ul style="list-style-type: none"> <li>• Answer incoming call feature is disabled. Enable answer incoming call feature (2.3.7).</li> <li>• Number of rings to answer may be programmed too high. Reprogram number of rings to answer.</li> </ul>
Electric strike locks on or gate operator holds open.	<ul style="list-style-type: none"> <li>• Excessive voltage drop on 24 VAC line.</li> <li>• Relay activation time zone is enabled. Disable relay activation time zone (4.9) or reprogram relay activation time zone (2.4.3).</li> <li>• Access code used was programmed under a hold open location code. Reprogram access code into a momentary activation location code (2.6.1).</li> <li>• A hold command was sent to the relay from the homeowner's phone. Deactivate the relay using the homeowner's phone (Tone open numbers, 4.13).</li> </ul>
Access code will not work.	<ul style="list-style-type: none"> <li>• Forgetting to press # first.</li> <li>• Access code is time zone restricted and the access code time zone is enabled. Disable access code time zone (4.8), reprogram time zone boundaries (2.4.4) or reprogram access code for momentary activation location code (2.6.1).</li> <li>• Access code is programmed under a time zone restricted location code and external time zone input (terminals 6 &amp; 9) is shorted (activated). Remove external time zone input or reprogram access code under a momentary activation location code (2.6.1).</li> </ul>

## 5.6 Accessories

**Secondary Keypads:** Allows remote activation of the system relays by use of the access codes. Does not provide any voice communication to the main unit or to the homeowner's telephone. P/N 1812-082 (surface mount); P/N 1812-197 (flush mount)

**Surge Suppressors:**

High voltage (115 V) suppressor. P/N 1879-080.

Phone line suppressor. P/N 1877-010.

Low voltage (28 V) suppressor. P/N 1878-010.

**Mounting Posts:**

Gooseneck mounting post with concrete base plate. P/N 1200-045.

Gooseneck mounting post – direct burial. P/N 1200-046.

**Back-Up Battery:** 12 volt .8 amp hour gel cell provides stand by power during power interruptions. P/N 1801-008.

**Postal Lock Box:** Provides a means for the mail carrier to enter the premise to deliver mail. P/N 1402-080.

**Magnetic Locks:** A variety of magnetic locks are available to meet individual application requirements. Contact your DoorKing dealer.

**Electric Strikes:** A variety of electric strikes are available to meet individual application requirements. Contact your DoorKing dealer.

**Time Clocks (External)** - 7 day and 365 day time clocks can be used to automatically open gate/door at pre-set time and days.

P/N 2600-791 - 7 day clock

P/N 2600-795 - 365 day clock

**CCTV Camera:** Camera mounted in phone system. P/N 1812-147 Day/Night. Not available for the wall mount model.

# 5.7 Programmed Information Log Sheets

Complete the information in the tables on the following pages to maintain a record of the information that has been programmed into the 1812 Classic entry system. 1812 Classic manual is available on-line at: [www.dkaccess.com](http://www.dkaccess.com) if extra log sheets are required.

Master Code			
1st Digit	2nd Digit	3rd Digit	4th Digit

Tone Open Numbers		
Relay		
Tone Number Function	1	2
Momentary Activation		
Hold Open		
Deactivate Relay		
Hold Open 1 Hr.		

Do Not Disturb Time Zone	
Beginning Time	
Ending Time	
Days of the Week	

Call Forward Time Zone	
Beginning Time	
Ending Time	
Days of the Week	

Access Code Time Zone	
Beginning Time	
Ending Time	
Days of the Week	

Preprogrammed Phone Numbers	
01	
02	
03	

Automatic Relay Activation Time Zones				
	Relay 1		Relay 2	
	Time Zone 1	Time Zone 2	Time Zone 3	Time Zone 4
Beginning Time				
Ending Time				
Days of the Week				

**Access Codes: 01 - 25 – Relay 1****26 - 50 – Relay 2**

<b>Relay 1</b>			<b>Relay 2</b>		
<b>Location Code</b>	<b>Function</b>	<b>Access Code #</b>	<b>Location Code</b>	<b>Function</b>	<b>Access Code #</b>
01	Momentary		26	Momentary	
02	Momentary		27	Momentary	
03	Momentary		28	Momentary	
04	Momentary		29	Momentary	
05	Momentary		30	Momentary	
06	Momentary		31	Momentary	
07	Momentary		32	Momentary	
08	Momentary		33	Momentary	
09	Momentary		34	Momentary	
10	Momentary		35	Momentary	
11	Momentary		36	Momentary	
12	Momentary		37	Momentary	
13	Momentary		38	Momentary	
14	Momentary		39	Momentary	
15	Flash (One Day)		40	Flash (One Day)	
16	Hold		41	Hold	
17	Hold		42	Hold	
18	Hold		43	Hold	
19	Hold		44	Hold	
20	Hold		45	Hold	
21	Time Zone		46	Time Zone	
22	Time Zone		47	Time Zone	
23	Time Zone		48	Time Zone	
24	Time Zone		49	Time Zone	
25	Time Zone		50	Time Zone	





[www.doorking.com](http://www.doorking.com)

DoorKing, Inc.  
120 S. Glasgow Avenue  
Inglewood, California 90301  
U.S.A.

Phone: 310-645-0023  
Fax: 310-641-1586