

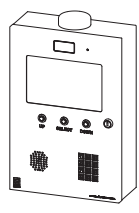



1 Unpack box and make sure you have all items shown here.



Ascent Unit



12-V AC/DC Adapter
(PS-12DC2)



Key



Carriage Bolt
(4x)



Hex Nut
(4x)

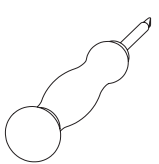

Screwdriver

2 Unlock and open unit for mounting, wiring, and setup.

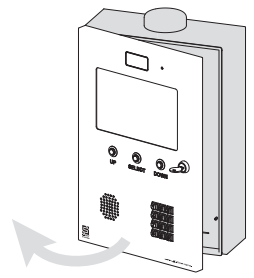

IMPORTANT

This Ascent unit **WILL NOT WORK** until the activation process is **COMPLETE!**

See the included **Activation Guide** to get this unit activated.

If you need help or have any questions, please contact **Summit Control** at **(972) 474-6422**.

WARNING

AUTOMATIC GATES CAN CAUSE SERIOUS INJURY OR DEATH!

ALWAYS CHECK THAT THE GATE PATH IS CLEAR BEFORE OPERATING!

REVERSING OR OTHER SAFETY DEVICES SHOULD ALWAYS BE USED!

3 Mount unit to pedestal using included mounting hardware. (This step may be completed later.)

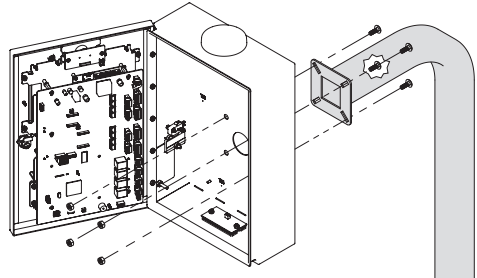

IMPORTANT

We recommend mounting the unit on a gooseneck pedestal using the included mounting hardware.

If using alternate mounting, the **4G LTE Antenna Extension Kit (Model 16-ANTX-1)** should be purchased and installed.

Failure to do so may result in NO SIGNAL!

CAUTION

Use all four carriage bolts when mounting the unit to a pedestal.

Leave the "hockey puck" antenna in place even if using an antenna extension.

Seal all openings created in the enclosure.

Failure to follow these instructions can damage the unit!

STOP

This is a cellular accessory for a gate or door. An uninterrupted cellular connection **CANNOT BE GUARANTEED!**

An emergency egress or primary entry mechanism **SHOULD ALWAYS BE USED!** (transmitter, fire box, mechanical release)

Consult with your dealer, distributor, and/or system designer for more information.

Continued on next page...

Using a Third-Party Power Source (Optional)

IMPORTANT

Verify your power source is compatible with the unit's electrical specifications below.

Not intended for solar applications!

Input	12-24 VAC/DC no more than 10% beyond this range
Current Draw	less than 690 mA @ 12 VDC less than 420 mA @ 24 VDC

P1 Connect wires to unit as shown in Step 4.

P2 Connect wires to your power source, making sure you connect positive to positive and negative to negative.

What's what?
All important components labeled

Unit shown with door fully open. Internal wiring not shown for clarity.

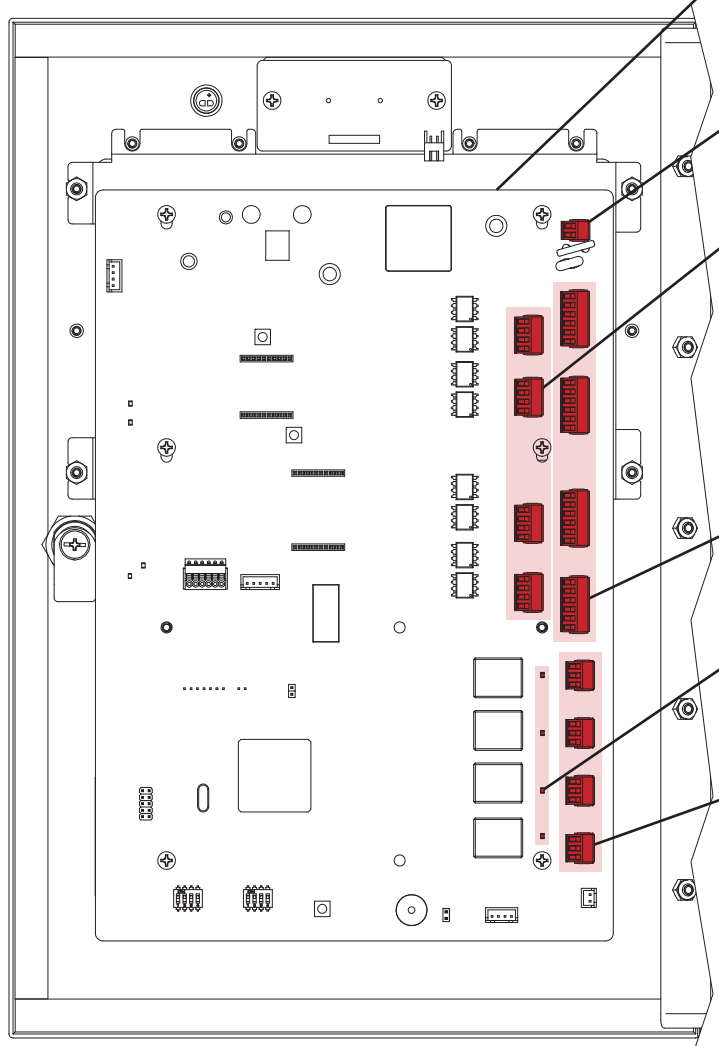

- Cellular Antenna Jacks and SIM Card**
Positioned on second circuit board behind main circuit board
- Power Terminals**
For wiring to power. See Page 2.
- Digital Input Terminals**
For connecting accessory devices. Scan QR code on next page for wiring instructions.
- Wiegand Terminals**
For wiring to Wiegand devices. See Page 2.
- Relay Status LEDs**
Relay is active when lit
- Relay Terminals**
For wiring to gate operator or door opener. See Page 2.

NEED HELP

Call **(972) 474-6422**
Email support@summitcontrol.com
We are available **Mon-Fri / 8am-5pm Central**

4 Connect wires

Feed wires through back of unit, and connect as shown using included screwdriver.

Consult gate/door opener manual for exact connections.

Terminals vary widely across manufacturers and models.

Additional wiring diagrams can be found below and online.

We recommend using 18-gauge stranded wire for all connections.

CAUTION

If the included 12-V AC/DC adapter will not be used, please go to **Page 1** and follow the procedure, **Using a Third-Party Power Source**.

Do not exceed 24 VAC/DC! Failure to choose a compatible power source can damage the unit!

Ascent terminals can be unplugged to make wire connections easier.

Third-Party 12-24-VAC/DC Power Source

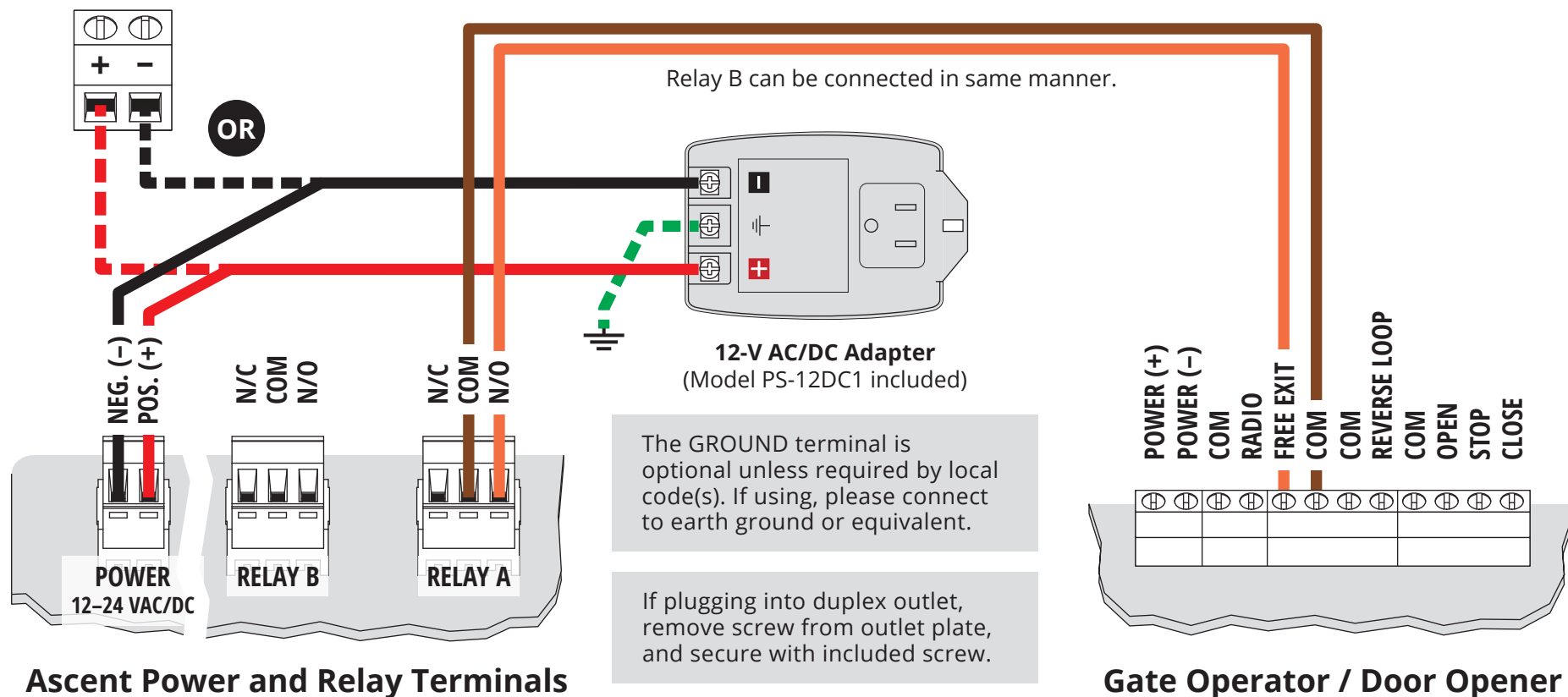

Ascent Power and Relay Terminals

Gate Operator / Door Opener

STOP

Before going forward, double check all wiring and make sure the unit has power!

A wiring diagram for connecting to Wiegand devices can be found below.

For connecting accessories not mentioned, please scan the QR code on this page.

Make sure the gate path is clear before completing Step 5!

5

Key in temporary code 2012 on keypad and confirm gate opens. If it does, close and lock unit.

2 0 1 2

Adding and deleting codes is done through Summit Control and **NOT** from keypad on unit!



INSTALLATION COMPLETE!

Now follow the **Activation Guide** to create an account and begin using Ascent.

A Wiegand Device

Feed wires through back of unit, and connect as shown using included screwdriver.

These terminals are used to connect a Wiegand device such as a card reader or Wiegand keypad.

Any set of Wiegand terminals can be used for wiring and then configured in Summit Control.

CAUTION

Disconnect power to the Ascent unit before connecting Wiegand devices.

Failure to disconnect power can damage the unit!

Need More?

Use the QR code below to get access to more resources, including how-to videos and additional wiring diagrams for connecting accessory devices.



Ascent terminals can be unplugged to make wire connections easier.

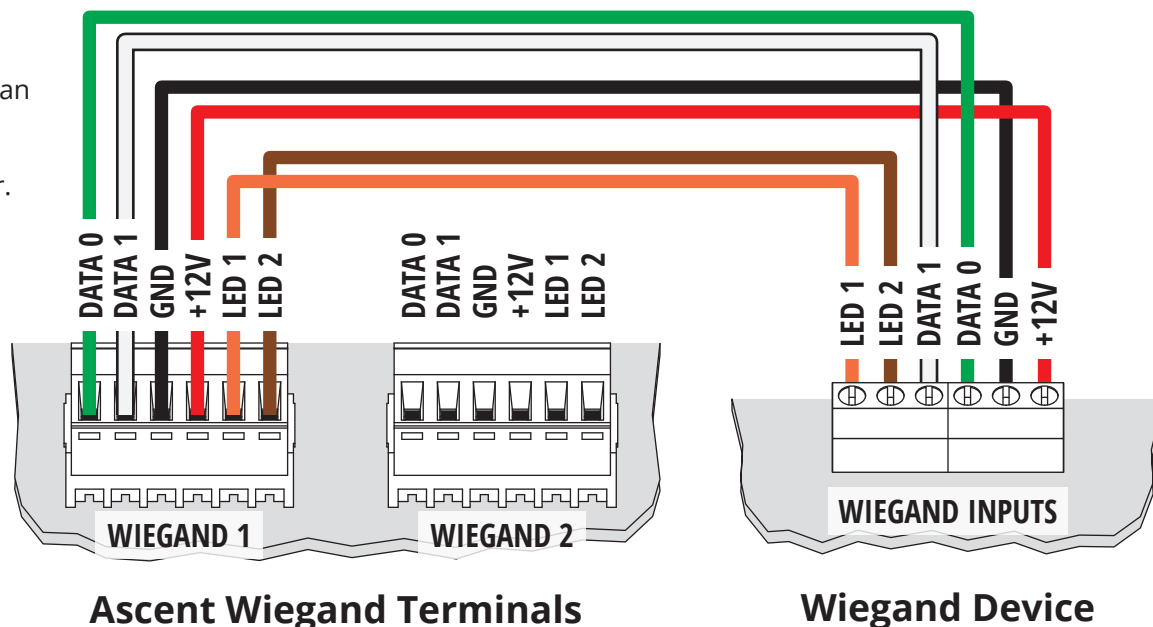

Ascent Wiegand Terminals

Wiegand Device