

STEAM&GO

User's Manual Garment Steamer

MODEL NO: SAG12



Please read all the instructions carefully before using this product

Thank you for purchasing model: SAG-12. This powerful and easy-to-use appliance can provide you new experience in steaming, garment hanging, dust cleaning and wrinkle removal. It is a necessary home appliance for modern household.

Important safety instructions

- 1、 Please make sure that the power supply is AC120V , 60Hz
- 2、 Do not operate another high-wattage appliance (i.e.:air conditioner,heater etc.) on the same circuit.
- 3、 Use the garment steamer only as described in this manual. Please follow the instruction of this manual to avoid accident.
- 4、 Do not immerse the garment steamer or its power cord or plug in water.
- 5、 Do not leave the garment steamer plugged in and unattended.
- 6、 This appliance is not intended for use by persons (including children) with reduced physical sensory or mental capabilities, or lack of experience and knowledge,unless they have been given supervision or instruction concerning use of the appliance by a person responsible for their safety.
- 7、 Do not operate the steamer if the water reservoir is empty.
- 8、 Do not lay hose on the ground or twist it.
- 9、 Be aware of the steam from the nozzle to avoid getting burned .
- 10、 Always move the appliance by grasping the telescopic pole. Do not force the casters if they are struck. Drain the water tank and water reservoir before inspecting the casters.
- 11、 Allow the appliance to cool down completely for at least 30 minutes and drain the water tank and water reservoir before storing.
- 12、 Unplug the unit BEFORE refilling or draining.
- 13、 Unplug the garment steamer.BEFORE maintenance.
- 14、 Keep the appliance from inflammable materials and chemicals.
- 15、 Do not use the garment steamer once Any power cord damage or malfunction is found.
- 16、 When unplugging your garment steamer is strictly prohibited , please grasp the plug with your hand. Do not unplug by yanking the power cord.
- 17、 Do not use the power cord board for extension, to avoid the hazard caused by the overload of the circuit.
- 18、 Do not fill the water tank with hot water or corrosive cleaning agent, otherwise, the garment steamer will be damaged. De-mineralized water or distilled water is strongly recommended.
- 19、 If the power cord is damaged, it should be changed by the certified electrician from the manufacturer or its agent, its maintenance department or after-sales service center.

Note



To avoid electricity leakage and other dangers. The garment steamer must be turned off BEFORE maintenance. If there is any abnormality, or the plug or electric wire is damaged, please don't use the machine, nor remove or change part by yourself, and please inform the service center of the company immediately.

Components

1. Steam nozzle
2. Hanger
3. Folding rack
4. Handle
5. Hose
6. Telescopic Pole
7. Connector nut
8. Hose connector
9. Water tank
10. Switch
11. Rear wheel
12. Folding rack
13. Fabric brush
14. Pant press
15. Steam board
16. Holding nips clips

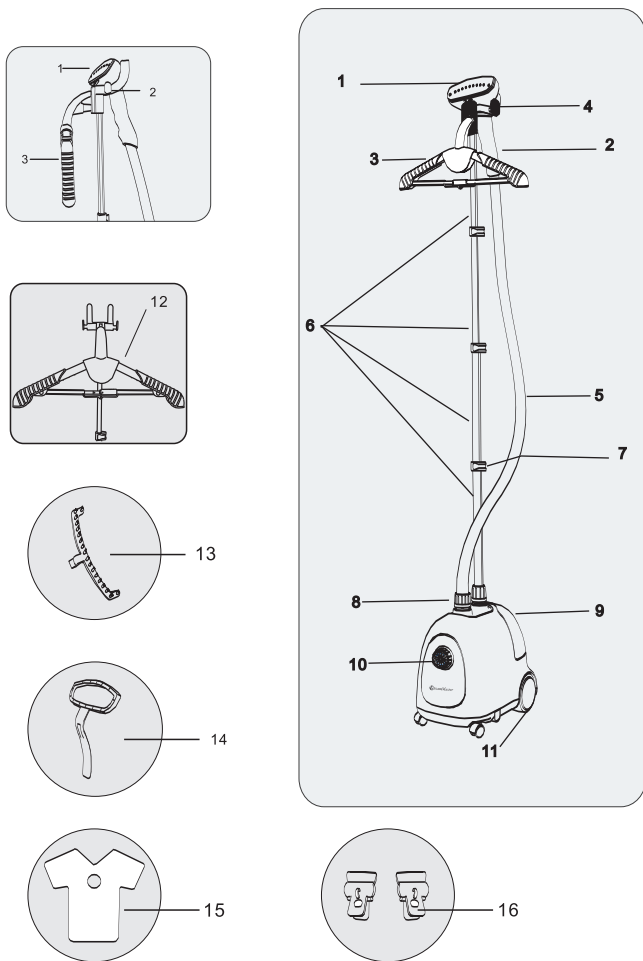

Figure 1

Product Features/Parameters

Models:SAG-12

water tank capacity: 1.5L

Steam output time: 45 seconds

Rated voltage: 120V , 60Hz

Rated power: 1500W

Setting up your garment steamer

- 1、 Put the hanger within in the telescopic pole along the flute. (Figure 2)
- 2、 Insert the telescopic pole into the pole base. (Figure 3)
- 3、 Screw the nut of pole base clockwise until its tightened.
- 4、 Loose the clips on the telescopic pole.
- 5、 Stretch the pole to its full extension, and then tighten the clip of telescopic pole.
- 6、 Install the hose connector into the hose connector according to the direction of arrow, and then turn in clockwise until it is tightened. Do not make it too tight. (Figure 3)
- 7、 Hang the steam nozzle on the steam nozzle hook. (Figure 4)

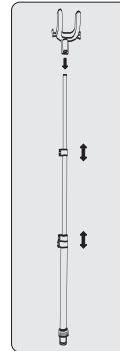

Figure2

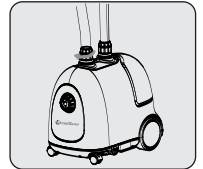
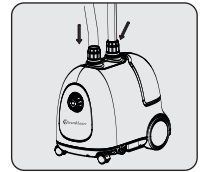

Figure3

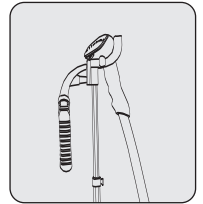

Figure4

Cautions :

- 1、 Put the nozzle on the hanger when the garment steamer is not in operation, to avoid injury by the steam .
- 2、 The telescopic pole shall be fully extended during operation, to ensure the steam hose is smooth unblocked and the steamer is in normal operation.
- 3、 Do not pull the steam hose with excessive force, otherwise, it will damage the hose or cause the steam leakage.
Do not move this machine with the steam hose.

Accessories Instructions

The brush can be fitted:

1. Turn off the garment steamer firstly, and wait until the steam stops spraying.
2. As Figure 5, make the buckle of the brush at the round hole of steam nozzle.
3. Press the brush to the steam nozzle until it is tightened.

Caution:

Please install the accessory only when the steam stops spraying. This accessory cannot be used with the pant press attached to the garment steamer at the same time)

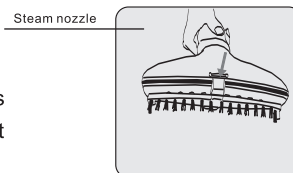
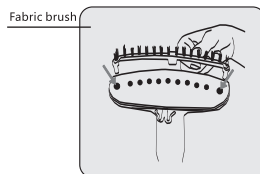

Figure 5

Instructions

- 1、 Before operation, please ensure the the garment steamer is turned off.
- 2、 Take out the water tank, twist off the water tank nut from the bottom (see Figure 6), and fill the water tank with cool water, and then tighten the water tank nut. To extend the service life of your garment steamer, we suggest you not to use the minerals water or distilled water. Put the water tank back. When the garment steamer is operating, don't use the water tank without water, otherwise, it will damage your garment steamer.
- 3、 Plug the unit in.
- 4、 Turn on the switch. When indicator is on, the garment steamer starts working. After 45 seconds, the steam will be sprayed from the nozzle.
- 5、 After steaming, turn off the garment steamer and unplug it .

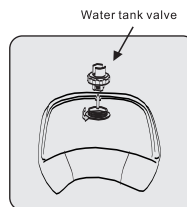

Figure 6

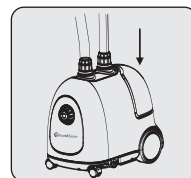
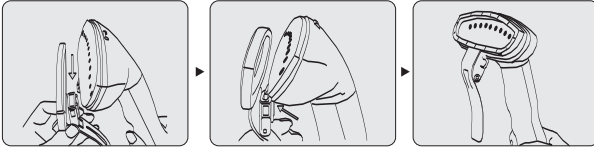

Figure 7

Fixing of pant press

Lean the pant press, so that the flute corner is close to the bulging fixed panel at the bottom of nozzle, and then gently buckle the trousers seam clip upwards along this corner, so the trousers seam clip could be fixed onto the nozzle directly.



(The brush and the pant press cannot be attached to the nozzle at the same time.)

Instructions for using the Folding Rack

1. Firstly, insert the hanger (A) in the pole (B) (as Figure a)
2. Insert the hook (D) of the folding rack (C) into the hole of hanger (A) about tilting 40° (as Figure b)
3. Press and fasten the hook (D) vertically (as Figure c)
4. Gently pull the hanging arm (E) of the folding rack with hands towards both sides, until two supporting poles (F) are on the same straight-line (as Figure d-e)
5. Push hard the positioning sleeve (G) to the supporting pole (F), to make the small hole of the positioning sleeve (G) align at the bump of the supporting pole (F) (as Figure f)

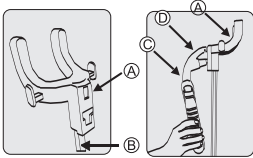

Figure a

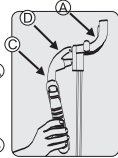

Figure b

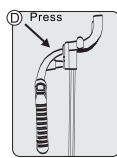

Figure c

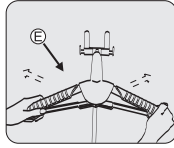

Figure d

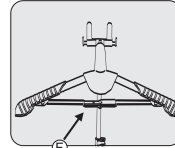

Figure e

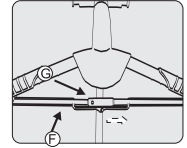

Figure f

USE INSTRUCTION OF THE HAND HELD STEAMING BOARD

FOR COLLAR

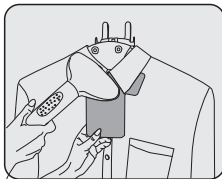

Figure 11

FOR POCKET

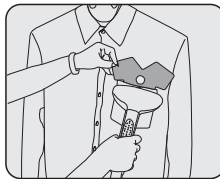

Figure 12

FOR EVERY CORNER

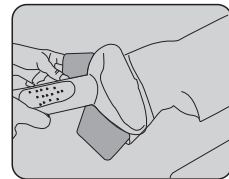
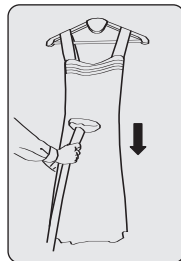

Figure 13

How to steam?

1. The high temperature steam is for softening the cloth fiber only, it is hard to iron the cloth just depending on the steam sprayed from the nozzle. The correct way of steaming cloth is to make the cloth straight with the pulling force. Therefore, this product demonstration point is: grasp the bottom of cloth with hands and pull it downwards. Take care to make the cloth surface as smooth as possible.



-
2. Then put the steam nozzle against the cloth firmly, gently press downwards, and then drag the nozzle up and down, softening the fiber by the high temperature steam, and then fixing the shape with the pulling force.

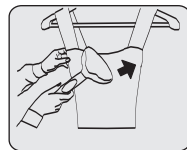

-
3. When ironing the bottom of the cloth, please grasp both sides of the cloth for tightening, and then steam from left to right, up and down. Please be aware of the hot steam from the nozzle.

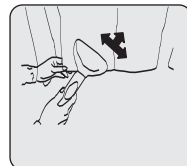

-
4. When ironing the collar, please press downward a little bit harder. The nozzle should be pressed on the folding of the collar for a little longer, and steam pressed back and forth, and up and down.

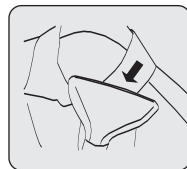
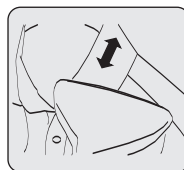

5. When ironing the cloth sleeves, please straighten the sleeve a little hard. The steam nozzle should be longer pressed on the sleeve folding of the sleeve for a little longer, and steam pressed back and forth

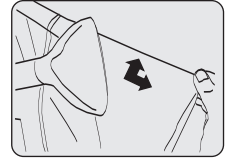

Ironing of Trousers Seam

When ironing the trousers seam, please gently press the bottom buckle of pant press downwards, so that the connectors of the nozzle and pant press are opened to clamp the trousers seam. Gently steam pressing the trousers seam back and forth, so that the trousers seam will become is straight and smooth.

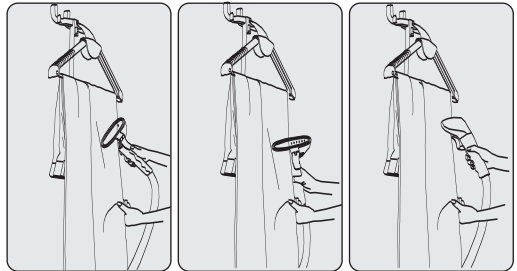

How to use the drain plug

To avoid the remaining water deteriorates and breeds bacteria when the steamer is not used for a long time, there is a drain plug on the side of your garment steamer. Just twist it in anticlockwise, it could easily drain the water. AFTER the water is drained, please tighten the valve in clockwise, to avoid water leakage.

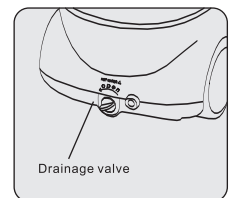

Figure 14

Cleaning and Maintenance

AFTER each use or if you don't use the garment steamer for a long time, we recommend you to carry on the following procedures

1. Please turn off your garment steamer. (Please turn to next page)
2. Wait until this garment steamer is complete cooling (at least 30 minutes).
3. Please shrink the telescopic pole to the shortest, and then put away the hose.
4. Please take out the water tank, and pour out its remaining water. Wash it with clear water, and pour out all water. Put the water tank back to the water reservoir.
5. Store the hose surrounding the telescopic hose, and then put the steam nozzle on the stand. (See Figure 9)
6. Store your garment steamer in the dry place.

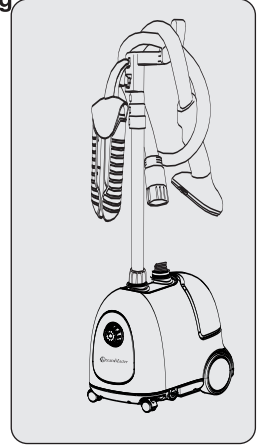

Figure 15

Removal of mineral build-up

Because of high water minerals content of water sources in many countries, the mineral build-up is a common problem for garment steamer. The mineral will remain inside the hose, so that the steam will be sprayed on and off, or even stuck in the hose.

If you DO NOT use the non-mineral water or distilled water, we recommend you to remove the mineral build-up every month as follows:

1. Turn off the garment steamer and turn off the power.
2. Twist and remove the steam hose and telescopic pole out of the garment steamer.
3. Remove the water tank, and drain the out the remaining water of machine inside the garment steamer.
4. Mix 50% vinegar and 50% water, in. In general, appropriate to 900ml mixing liquid is enough.
5. Inject the above mixing liquid from the steam hose connector into the garment steamer slowly.
6. If there is no mixing liquid in the water reservoir hole, please continue to inject the mixing liquid from the steam hose connector, until it is filled half of the water reservoir and close to the top of the steam hose.
7. Wait for 40 minutes.
8. Please turn on the drainage valve, pour the mixing liquid from the water reservoir and drainage valve to the water reservoir or bathtub.
9. Lean the garment steamer body, and then pour the mixing liquid from the steam hose connector to the water reservoir or bathtub.
10. Fill the clear water in the steam hose connector and water reservoir, and then pour all out. Repeat it for several times, until the mixing liquid is clean out.
11. Recombine each accessories, it may be for continuous use.

Troubleshooting

Problems	Reason	Solution
The garment steamer fails to spray the steam, and the indicating light does not illuminate.	The steamer is not plugged in	Insert the plug into the electrical outlet
	The housing power fuse is tripping off or blew out	Check the power or ask for qualified electrician's help
The garment steamer fails to spray the steam, and the indicating light illuminates.	There is sediment accumulation in the water tank	Refer to the instruction manual for the cleaning method of sediment.
	There is no water in the water tank	Refill the water sink in the water tank.
The steam hose makes a noise	The steam is condensed inside the steam hose, and become the small drop, so that it stops the steam to spray normally	It is normal that there is a little sound when spraying the steam. If it is too noisy, please make the steam hose become vertical, so that the water will flow back to the water tank
The steam is successively spraying	There is sediment accumulation in the water tank	It is normal that the steam stops to spray for several seconds. If it stops for long time, please refer to the instruction manual for the cleaning method of sediment

STEAM&GO