

# MODELS HW-120M, 160M, 200M, 225M

## COMMERCIAL GAS COPPER HEAT EXCHANGER WATER HEATER

### BURKAY UP-FLOW MODELS

Including Models with Intermittent Pilot Ignition (I.I.D.)

• Installation • Operation • Maintenance • Limited Warranty



LOW LEAD  
CONTENT

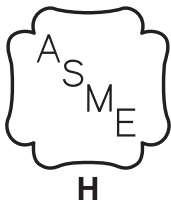

**WARNING:** If the information in these instructions are not followed exactly, a fire or explosion may result causing property damage, personal injury or death.

—Do not store or use gasoline or other flammable vapors and liquids in the vicinity of this or any other appliance.

—WHAT TO DO IF YOU SMELL GAS

- Do not try to light any appliance.
- Do not touch any electrical switch; do not use any phone in your building.
- Immediately call your gas supplier from a neighbor's phone. Follow the gas supplier's instructions.
- If you cannot reach your gas supplier, call the fire department.

— Installation and service must be performed by a qualified installer, service agency or the gas supplier.



### ! WARNING

Read and understand this manual and all Warnings and Cautions within before installing and using this appliance.

Place these instructions adjacent to water heater and notify owner to keep for future reference.

# A.O. Smith®

500 Tennessee Waltz Parkway  
Ashland City, TN 37015  
[www.hotwater.com](http://www.hotwater.com)

PLACE THESE INSTRUCTIONS ADJACENT TO HEATER  
AND NOTIFY OWNER TO KEEP FOR FUTURE REFERENCE

# GENERAL SAFETY



## ⚠️ WARNING

Read and understand this manual and all Warnings and Cautions within before installing and using this appliance.

Place these instructions adjacent to water heater and notify owner to keep for future reference.

## ⚠️ DANGER

### Fire or Explosion Hazard

- Do not store or use gasoline or other flammable vapors and liquids in the vicinity of this or any other appliance.

Flammable Vapors

## ⚠️ DANGER

Untempered hot water can cause severe burns instantly resulting in severe injury or death.

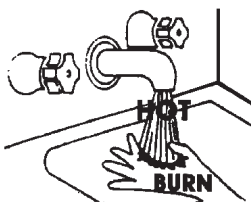

Children, elderly, and the physically or mentally disabled are at highest risk for scald injury.

Feel water before bathing or showering. Temperature limiting valves are available.

Read instruction manual for safe temperature setting.

## ⚠️ WARNING

### Explosion Hazard

- Overheated water can cause water tank explosion.
- Properly sized temperature and pressure relief valve must be installed on the storage tanks.

## ⚠️ WARNING

### Fire or Explosion Hazard

- Do not store or use gasoline or other flammable vapors and liquids in the vicinity of this or any other appliance.
- Avoid all ignition sources if you smell any gases.
- Do not expose water heater control to excessive gas pressure.
- Use only gas shown on rating plate.
- Maintain required clearances to combustibles.
- Keep ignition sources away from faucets after extended period of non-use.

Read instruction manual before installing, using or servicing.

## ⚠️ WARNING

### Breathing Hazard - Carbon Monoxide Gas

- Special consideration must be taken with installations above 2000 feet.
- Please contact an AO Smith qualified service agent to obtain the proper setup and instructions before lighting.
- Failure to implement the proper setup will result in improper and inefficient operation of the appliance resulting in production of increased levels of carbon monoxide gas in excess of the safe limits which could result in serious personal injury or death.

Breathing carbon monoxide can cause brain damage or death. Always read and understand instruction manual.

## ⚠️ WARNING

### Fire Hazard

For continued protection against risk of fire:

- Do not install water heater on carpeted floor.
- Do not operate water heater if flood damaged.

## CAUTION

### Improper installation and use may result in property damage.

- Do not operate water heater if flood damaged.
- Install in location with drainage.
- Fill water heater with water before operation.
- Be alert for thermal expansion.

Refer to instructions in this manual for installation, operating, and service.





# SAFE INSTALLATION, USE AND SERVICE

---

Your safety and the safety of others is extremely important in the installation, use, and servicing of this water heater.

Many safety-related messages and instructions have been provided in this manual and on the water heater to warn you and others of a potential injury hazard. Read and obey all safety messages and instructions throughout this manual. It is very important that the meaning of each safety message is understood by you and others who install, use, or service this boiler.

	This is the safety alert symbol. It is used to alert you to potential personal injury hazards. Obey all safety messages that follow this symbol to avoid possible injury or death.
---	--

	DANGER indicates an imminently hazardous situation which, if not avoided, will result in injury or death.
	WARNING indicates a potentially hazardous situation which, if not avoided, could result in injury or death.
	CAUTION indicates a potentially hazardous situation which, if not avoided, could result in minor or moderate injury.
	CAUTION used without the safety alert symbol indicates a potentially hazardous situation which, if not avoided, could result in property damage.

All safety messages will generally tell you about the type of hazard, what can happen if you do not follow the safety message and how to avoid the risk of injury.

---

## IMPORTANT DEFINITIONS

---

- **Qualified Installer:** A qualified installer must have ability equivalent to a licensed tradesman in the fields of plumbing, electricity, air supply, venting and gas supply, including a thorough understanding of the requirements of the National Fuel Gas Code as it relates to the installation of gas fired boilers. The qualified installer must have a thorough understanding of this instruction manual.
- **Service Agency:** A service agency also must have ability equivalent to a licensed tradesman in the fields of plumbing, electricity, air supply, venting and gas supply, including a thorough understanding of the requirements of the National Fuel Gas Code as it relates to the installation of gas fired boilers. The service agency must also have a thorough understanding of this instruction manual, and be able to perform repairs strictly in accordance with the service guidelines provided by the manufacturer.
- **Gas Supplier:** The Natural Gas or Propane Utility or service who supplies gas for utilization by the gas burning appliances within this application. The gas supplier typically has responsibility for the inspection and code approval of gas piping up to and including the Natural Gas meter or Propane storage tank of a building. Many gas suppliers also offer service and inspection of appliances within the building.

# ROUGH-IN-DIMENSIONS

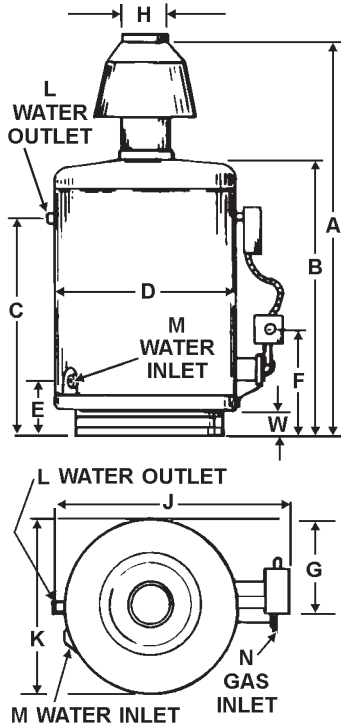

TABLE 1 - ROUGH-IN DIMENSIONS

Models Dimensions	HW-120M		HW-160M		HW-200M		HW-225M	
	Inches	mm	Inches	mm	Inches	mm	Inches	mm
A	49 3/8	1254	50 1/8	1273	53 1/4	1353	60	1524
B	30 3/8	772	30 3/8	772	33 1/8	841	33 1/8	841
C	23 5/8	600	23 5/8	600	27 1/8	689	27 1/8	689
D	20 3/4	527	20 3/4	527	20 3/4	527	20 3/4	527
E	5 1/2	140	5 1/2	140	5 1/2	140	5 1/2	140
F	10	254	10	254	10	254	10	254
G	11 13/16	300	11 13/16	300	11 13/16	300	11 13/16	300
H	6	152	7	178	7	178	7	178
J	26 11/16	678	26 11/16	678	26 11/16	678	26 11/16	678
K	20 3/4	527	20 3/4	527	20 3/4	527	20 3/4	527
L	1 1/4 NPT		1 1/4 NPT		1 1/4 NPT		1 1/4 NPT	
M	1 NPT		1 NPT		1 NPT		1 NPT	
N	1/2 NPT		1/2 NPT		1/2 NPT		1/2 NPT	
W	1 3/4	44	1 3/4	44	1 3/4	44	1 3/4	44
Approx. Shipping Weight	120 lbs.	54 Kg.	155 lbs.	70 Kg.	165 Lbs.	75 Kg.	175 lbs.	79 Kg.

## HEATER PERFORMANCE DATA

NOTE: To compensate for the effects of high altitude areas above 2000 feet, input rating, and therefore recovery ratings, should be reduced approximately 4% for each 1000 feet above sea level.

TABLE 2 - RECOVERY CAPACITIES

Model	Input		U.S. Gallons/Hrs. and Litres/Hr. at TEMPERATURE RISE INDICATED						
			T °F	20	40	50	60	70	80
	BTUH	KW	T °C						
HW 120	120000	35	GPH	576	288	230	192	164	144
			LPH	2179	1090	872	726	623	545
HW 160	160000	47	GPH	767	384	307	256	219	192
			LPH	2905	1453	1162	968	830	726
HW 200	199000	58	GPH	954	477	382	318	273	239
			LPH	3614	1807	1445	1205	1032	903
HW 225	225000	66	GPH	1079	540	432	360	308	270
			LPH	4086	2043	1634	1362	1167	1021

Recovery rating of models shown in chart above are obtained by actual efficiency test data by recognized Certification Agency.

TABLE 3 - GAS AND ELECTRIC CHARACTERISTICS

Model	Manifold Pressure			Maximum Supply Pressure		Minimum Supply Pressure	
	Type of Gas	Inches W.C.	kPa	Inches W.C.	kPa	inches W.C.	kPa
HW-120M thru 225M	NATURAL	3.5	0.87	10.5	2.61	5	1.25
HW-120M thru 200M	PROPANE	10	2.49	13.0	3.23	11	2.74

Minimum Pressure must be maintained under both load and no load (static and firing) conditions. Electrical characteristics: 120 volts/60 Hz and less than 5 amps.

# FOREWORD

This design complies with the current edition of the ANSI Standard Z21.10.3 for gas water heaters Vol. III Storage Water Heaters with input ratings above 75,000 BTU per hour Circulating and Instantaneous.

Detailed installation instructions are in this manual. These instructions will serve to provide the installer with a reference for the materials and method of piping suggested. IT IS ESSENTIAL THAT ALL WATER AND GAS PIPING AND THE ELECTRICAL WIRING BE INSTALLED AND CONNECTED AS SHOWN IN THE DIAGRAMS.

You should thoroughly read and understand this manual before installation and operation of this unit.

CHECK THE DIAGRAMS THOROUGHLY BEFORE STARTING INSTALLATION TO AVOID POSSIBLE ERRORS AND TO MINIMIZE TIME AND MATERIALS COST.

Particular attention should be given to the installation of thermometers at the locations indicated in the diagrams as these are necessary for checking the operation of the heater.

MAKE SURE THE GAS ON WHICH THE HEATER WILL OPERATE IS THE SAME AS THAT SPECIFIED ON THE HEATER MODEL AND RATING PLATE.

The factory warranty will be void if the unit(s) have been improperly installed or operated.

In addition to these instructions, the water heater(s) shall be installed in accordance with those installation regulations in force in the local area where the installation is to be made. These shall be carefully followed in all cases. Authorities having jurisdiction should be consulted before installations are made.

To comply with NSF Standard 5 installation requirements the bottom of the water heater must be sealed to the floor with a silicone based sealant or elevated 6 inches above the floor.

In absence of local codes, the installation must comply with the latest editions.

### In the United States:

The National Fuel Gas Code, ANSI Z223.1 and the National Electric Code, NFPA 70.

### In Canada:

The Installation Code CAN/CGA B149.1 and .2 (latest edition) and the Canadian Electric Code, CSA C22.1.

These are available from the Canadian Standards Association, 8501 East Pleasant Valley Road, Cleveland, OH 44131, USA, or, Canadian Gas Association Laboratories, 55 Scarsdale Road, Don Mills, Ontario M3B 2R3, Canada.

# TABLE OF CONTENTS

	PAGE		PAGE
GENERAL SAFETY INFORMATION.....	2	PIPING DIAGRAMS .....	13
ROUGH-IN DIMENSIONS.....	4	Gas Connections.....	16-17
FOREWORD .....	5	Electrical Information .....	17-18
Precautions .....	5-6	OPERATION.....	19
Grounding Instructions .....	6	Important .....	19
Chemical Vapor Corrosion .....	6	General.....	19
Propane Gas Models.....	6	Filling .....	19
High Altitude Installations .....	6	Gas Line Leak Testing.....	19
FEATURES.....	7	Purging .....	19
Automatic Gas Shutoff Control.....	7	Operating Instructions For I.I.D Models.....	20
Protector Switch (Coil High Limit).....	7	Checking And Adjusting The Input .....	21
Thermal Balancer .....	7	SERVICE INFORMATION.....	22
Intermittent Ignition Control Module .....	7-8	Pilot And Main Burner Maintenance .....	22
Circulating Pump.....	8	I.I.D. Pilot Burner.....	22
Tank Temperature Control (Not Supplied).....	8	Protector Switch (Coil High Limit-All Heaters).....	23
Safety Flow Switch (Not Supplied).....	8-9	Tank Temperature Control.....	23
Drain Valve (Not Supplied).....	9	Automatic Gas Shutoff Control.....	23
Thermometers (Not Supplied).....	9	Thermal Balancer.....	23
INSTALLATION INSTRUCTIONS .....	10	Inspecting The Heat Exchanger And Venting System.....	23
Important .....	10	Gas Pressure Regulator.....	22
Required Ability .....	10	Relief Valve .....	24
Location .....	10	Circulating Pump .....	24
Installation Clearances.....	10	Electrical Service.....	24
Levelling .....	10	Replacement Parts.....	24
Air Requirements.....	10-11	PREVENTIVE MAINTENANCE.....	24
Venting .....	11	Recommended Procedure For Periodic Removal Of Lime	
Relief Valve .....	11-12	Deposits From Coil Type Commercial Water Heaters.....	24-25
Hard Water .....	12	Deliming Solvents.....	25
Closed Water Systems.....	12	Removing Light Deposits .....	25
Thermal Expansion .....	12	Heavy Lime Deposits .....	25-26
Water Line Connections.....	12	CHECKOUT .....	26
Water (Potable) Heating.....	12	LIMITED WARRANTY .....	35

# GENERAL SAFETY INFORMATION

## PRECAUTIONS

DO NOT USE THIS WATER HEATER IF ANY PART HAS BEEN UNDER WATER. Immediately call a qualified service agent to inspect the water heater and to replace any part of the control system and any gas control which has been under water.

IF THE UNIT IS EXPOSED TO THE FOLLOWING, DO NOT OPERATE HEATER UNTIL ALL CORRECTIVE STEPS HAVE BEEN MADE BY A QUALIFIED SERVICE AGENT.

1. EXTERNAL FIRE.
2. DAMAGE.
3. FIRING WITHOUT WATER.
4. SOOTING

KEEP THE HEATER AREA CLEAR AND FREE FROM COMBUSTIBLE MATERIALS, GASOLINE AND OTHER FLAMMABLE VAPORS AND LIQUIDS. AREA AROUND HEATER MUST NOT CONTAIN OBSTRUCTING MATERIAL TO THE FLOW OF COMBUSTION AND VENTILATING AIR.

SHOULD OVERHEATING OCCUR OR THE GAS SUPPLY FAIL TO SHUT OFF, TURN OFF THE MANUAL GAS CONTROL VALVE TO THE WATER HEATER.

Heater must be protected from freezing downdrafts during shutdown periods.

## GROUNDING INSTRUCTIONS

This water heater must be grounded in accordance with the National Electric Code and/or local codes. These must be followed in all cases.

This water heater must be connected to a grounded metal, permanent wiring system; or an equipment grounding conductor must be run with the circuit conductors and connected to the equipment grounding terminal or lead on the water heater.

## CHEMICAL VAPOR CORROSION



### WARNING

CORROSION OF THE FLUEWAYS AND VENT SYSTEM MAY OCCUR IF AIR FOR COMBUSTION CONTAINS CERTAIN CHEMICAL VAPORS. SUCH CORROSION MAY RESULT IN FAILURE AND RISK OF ASPHYXIATION.

Spray can propellants, cleaning solvents, refrigerator and air conditioning refrigerants, swimming pool chemicals, calcium and sodium chloride (water softener salt), waxes, and process chemicals are typical compounds which are potentially corrosive. Do not store products of this sort near the heater. Also, air which is brought in contact with the heater should not contain any of these chemicals. If necessary, uncontaminated air should be obtained from remote or outside sources. The limited warranty is voided when failure of water heater is due to a corrosive atmosphere. (Refer to the limited warranty for complete terms and conditions.)

## PROPANE GAS MODELS

Water heaters for propane or liquefied petroleum gas (LPG) are different from natural gas models. A natural gas heater will not function safely on LP gas and no attempt should be made to convert a heater from natural to LP gas.

LP gas must be used with great caution. It is highly explosive and heavier than air. It collects first in low areas making odor difficult to detect at nose level. If LP gas is present or even suspected, do not attempt to find the cause yourself. Go to a neighbor's house, leaving your doors open to ventilate the house, then call your gas supplier or service agent. Keep area clear until a service call has been made.

At times you may not be able to smell an LP gas leak. One cause is odor fade, which is a loss of the chemical odorant that gives LP gas its distinctive smell. Another cause can be your physical condition, such as having a cold or diminishing sense of smell with age. For these reasons, the use of a propane gas detector is recommended.

IF YOU EXPERIENCE AN OUT-OF-GAS SITUATION, DO NOT TRY TO RELIGHT APPLIANCES YOURSELF. Only trained LP professionals should conduct the required safety checks in accordance with industry standards.

## HIGH ALTITUDE INSTALLATIONS



### WARNING

INSTALLATIONS ABOVE 2000 FEET REQUIRE REPLACEMENT OF THE BURNER ORIFICE IN ACCORDANCE WITH THE NATIONAL FUEL GAS CODE (ANSI Z223.1). FOR CANADIAN INSTALLATIONS CONSULT CANADIAN INSTALLATION CODES AND CAN/CGA B149. FAILURE TO REPLACE THE ORIFICES WILL RESULT IN IMPROPER AND INEFFICIENT OPERATION OF THE APPLIANCE RESULTING IN THE PRODUCTION OF INCREASED LEVELS OF CARBON MONOXIDE GAS IN EXCESS OF SAFE LIMITS WHICH COULD RESULT IN SERIOUS PERSONAL INJURY OR DEATH.

You should contact your gas supplier for any specific changes which may be required in your area.

As elevation above sea level is increased, there is less oxygen per cubic foot of gas. Therefore, the heater input rate should be reduced at high altitudes for satisfactory operation with the reduced oxygen supply. Failure to make this reduction could result in an overfiring of the heater, causing sooting, poor combustion and/or unsatisfactory heater performance.

## U.S. REQUIREMENTS

Ratings specified by manufacturers for most appliances apply for elevations up to 2000 feet (610m). For elevations above 2000 feet (610m), ratings must be reduced at the rate of 4% for each 1000 feet (305m) above sea level. For example, if a heater is rated at 120,000 Btuh (35 Kwh) at sea level, to rate the heater at 4000 feet (1219m), you subtract 4 (once for each thousand feet) x .04 (4% input reduction) x 120,000 (original rating) from the original rating. Therefore, to calculate the input rating at 4,000 feet (121.9m):  $4 \times .04 \times 120,000 = 19,200$  Btuh (5.6 Kwh),  $120,000 (35 Kwh) - 19,200 (5.6Kwh) = 100,800$  Btuh (29.4 Kwh). At 6000 feet (1829m) the correct input rating should be 91,200 Btuh (26.7 Kwh).

The input reduction is primarily achieved by reducing the size of the main burner orifice. To do this, the main burner orifices require replacement with orifices sized for the particular installation elevation. Correct orifice sizing and parts may be obtained from A.O. Smith corporation. When ordering, be sure to state the model number and the altitude of the location where the water heater is being installed.

Upon completion of derating of the heater, adjustment to the gas pressure regulator may be required. See CHECKING THE INPUT section in this manual for inlet and manifold pressure requirements.

Also due to the input rating reduction required at high altitudes, the output rating of the appliance is reduced and should be compensated for in the sizing of the equipment for the application.

# FEATURES

TABLE 4.

Control Device	Factory Setting	Field Adjustment
Heater Automatic Gas Shutoff Control	Fixed 195°F (90.5°C) cut out temp. 190°F (87.7°C) cut in temp.	Non-adjustable
Heater Protector Switch	Fixed 250°F (121°C) cut out temp. 200°F (93.3°C) cut in temp.	Non-adjustable
Tank Temperature Control Safety Flow Switch	Field Supplied and Installed See Table 1	Adjust to Requirements Field Adjustable

## AUTOMATIC GAS SHUTOFF CONTROL

The automatic gas shutoff control, fig. 1, is an automatic safety device which activates at a water temperature of approximately 195°F (90.5°C). This limits the water outlet temperature to a maximum of 200°F (87.7°C).

The device is wired in series with the gas valve. The control will automatically reset when the water temperature cools to approximately 190°F (87.7°C).

Should the automatic gas shutoff control activate during a heating cycle, the heater's gas valve will close; extinguishing the main burners. The pilot burner will also be extinguished. The circulating pump will continue operating as long as the storage tank thermostat continues to "call for heat". When the water temperature in the heater drops to 180°F (82.2°C) or below the control module will begin an ignition cycle which will relight the pilot burner and main burners. Re-ignition of the main burners will occur if the storage tank thermostat continues to call for heat. Otherwise, the normal operating cycle will resume on the thermostat's next call for heat.

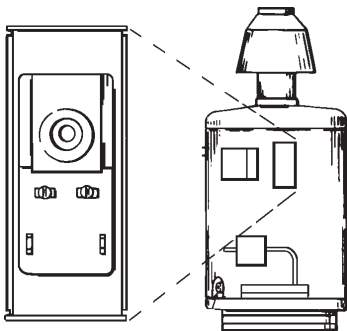

AUTOMATIC GAS SHUTOFF CONTROL  
FIGURE 1

### PROTECTOR SWITCH (Coil High Limit)

This heater is equipped with a manually reset protector switch, Figure 2, located under the small cover on the side of the jacket. This device provides positive shutdown of the heater in the event of heater or system malfunction. Should the surface temperature of the copper tubing heat exchanger reach 250°F (121.1°C), the protector switch will activate. The gas valve will close, and the pilot and main burners will be extinguished. To resume heater operation, the protector switch must be manually reset (remove the protector switch cover and push the reset button) after the coil surface temperature cools to less than 200°F (93.3°C).

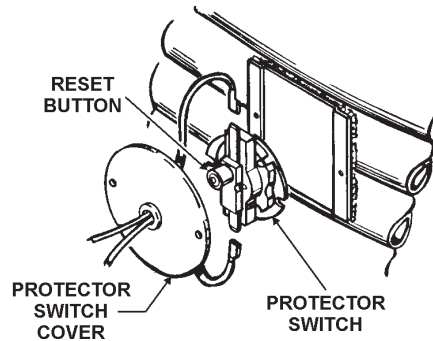

FIGURE 2

DO NOT RESET THIS SWITCH WITHOUT PERFORMING THE SYSTEM CHECKS OUTLINED UNDER PROTECTOR SWITCH IN THE SERVICE INFORMATION SECTION. ALSO, SEE CHART ONE UNDER THE CHECKOUT SECTION. IF NECESSARY, CALL A QUALIFIED SERVICE AGENT. Once the cause of the protector switch activation has been determined and corrected, it will be necessary to restart the heater following the LIGHTING AND OPERATING instructions.

## THERMAL BALANCER

The thermal balancer (standard on Models HW-200M and HW-225M, optional on Models HW-120M and HW-160M) is a delay relay used only on Cer-Temp 80 Recovery systems. It gives immediate pump start but delay of pump shutoff for approximately 2 minutes. Residual heat in the heat exchanger is then recovered after shutdown. This improves efficiency and balances heater temperature with tank temperature at shutdown.

## INTERMITTENT IGNITION CONTROL MODULE

The Honeywell control module contain the electronic components of the system and also serve as a central wiring system for the controls mounted on the heater. The control module performs the following functions:

1. Checks for safe-start by sensing for a flame or false flame condition on start-up.
2. Generates a potential of 15,000 volts for spark ignition of the pilot burner.
3. Turns on or off power to the pilot valve.

4. Discontinues ignition spark when pilot flame is established. The S8600/S8610 control used on propane gas models provides safety lockout if pilot fails to ignite within the pilot flame establishing period. The S-8600/S-8610 control used on natural gas models continues trial for ignition until pilot flame is established.
5. After proof-of-pilot flame, opens the main valve.
6. On a power loss, shuts the heater down. When power is restored it will begin a new ignition cycle.
7. On a loss of flame, shuts off main gas and starts trial for pilot ignition.

PLEASE SEE TROUBLE SHOOTING SECTION FOR MORE INFORMATION.

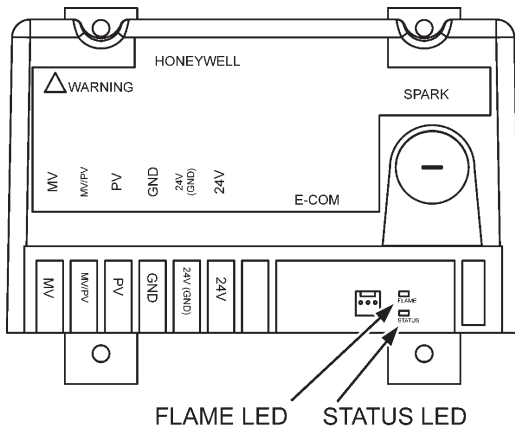

**INTERMITTENT IGNITION CONTROL MODULE (I.I.D.)  
FIGURE 3**

### CIRCULATING PUMP

Constant circulating pump operation of the heater voids the warranty. Constant water flow through the unit will “wash” away the copper’s natural protective coating. This is called velocity erosion. This erosion is not as great a problem when intermittent circulating operation is used per the recommended installation procedure. Constant circulation of water between the storage tank and the building is permissible as long as the water does not constantly flow through the heater.

Only all bronze circulating pumps are used with commercial water heaters.

Although circulating pumps are originally oiled and operated by the manufacturer, THEY MUST BE OILED AGAIN BEFORE OPERATED. Follow the manufacturer’s instructions. See fig. 4.

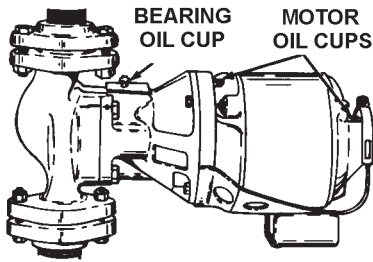

**TYPICAL CIRCULATING PUMP  
FIGURE 4**

Follow the same oiling procedure if a replacement circulating pump is installed into the system.

### TANK TEMPERATURE CONTROL (NOT SUPPLIED)



USE ANTI-SCALD VALVE(S) in the hot water system to reduce the risks of scalds at points of use such as lavatories, sinks and bathing facilities.

The tank temperature control is located in the lower portion of the hot water storage tank, see PIPING DIAGRAMS. It is the primary operating control of the system and regulates the water temperature in the tank.

The storage tank thermostat should have contact ratings that exceed the maximum electrical requirements of the system. Typically, the thermostat should have motor full load and locked rotor current ratings which exceed the total amount of current required to drive the pump(s) controlled by the thermostat.

The thermostat should have a temperature range of 100°F (37.7°C) to 180°F (82.2°C) or more. The preferred initial setting for the storage tank thermostat is 120°F (48.8°C). However, for normal use, the thermostat should be adjusted to the lowest setting which produces an acceptable hot water supply temperature. This will always give the most energy efficient operation. Do not adjust the thermostat to achieve a storage temperature of 190°F (87.7°C) or above. This action may cause the automatic gas shutoff control to activate shutting down the heater.

Intermittent ignition device and circulating pump start and stop simultaneously as the tank thermostat contacts open and close. This basic action, water flowing whenever the burner operates, must not be altered.

### SAFETY FLOW SWITCH (NOT SUPPLIED)

The safety flow switch is a safety device installed at the water outlet of the unit to prevent main burner operation in the event of inadequate water flow through the unit.

An accessory package No. 9005680205 containing a safety flow switch is available for this application.

This switch may be mounted in a horizontal pipe line or a vertical pipe line with upward water flow. Do not install the switch where the water flow is downward.

For proper performance mount the switch in a section of pipe where there is a straight run of at least 5 pipe diameters on each side of the flow switch (i.e. do not locate adjacent to valves, elbows, orifices, etc.).

The flow switch shall be mounted in a standard 1" x 1" x 1" tee for a 1" pipe application. For larger pipe sizes use a reducing tee in order to keep the switch as close to the pipe as possible. Install the flow switch in the branch (top) opening of the reducing tee and provide adequate paddle length in the flow stream. For example in a 2" pipe installation use a 2" x 2" x 1" reducing tee. For 1", 2" or 3" pipe use the paddle segments as supplied. For other pipe sizes (i.e. 1 1/4", 1 1/2", and 2 1/2") trim the paddle to the proper pipe size, see fig. 5. If a standard tee is used, install a face or hex bushing in the top opening. The paddle must be adjusted or trimmed to the size of the pipe in which it will be installed.



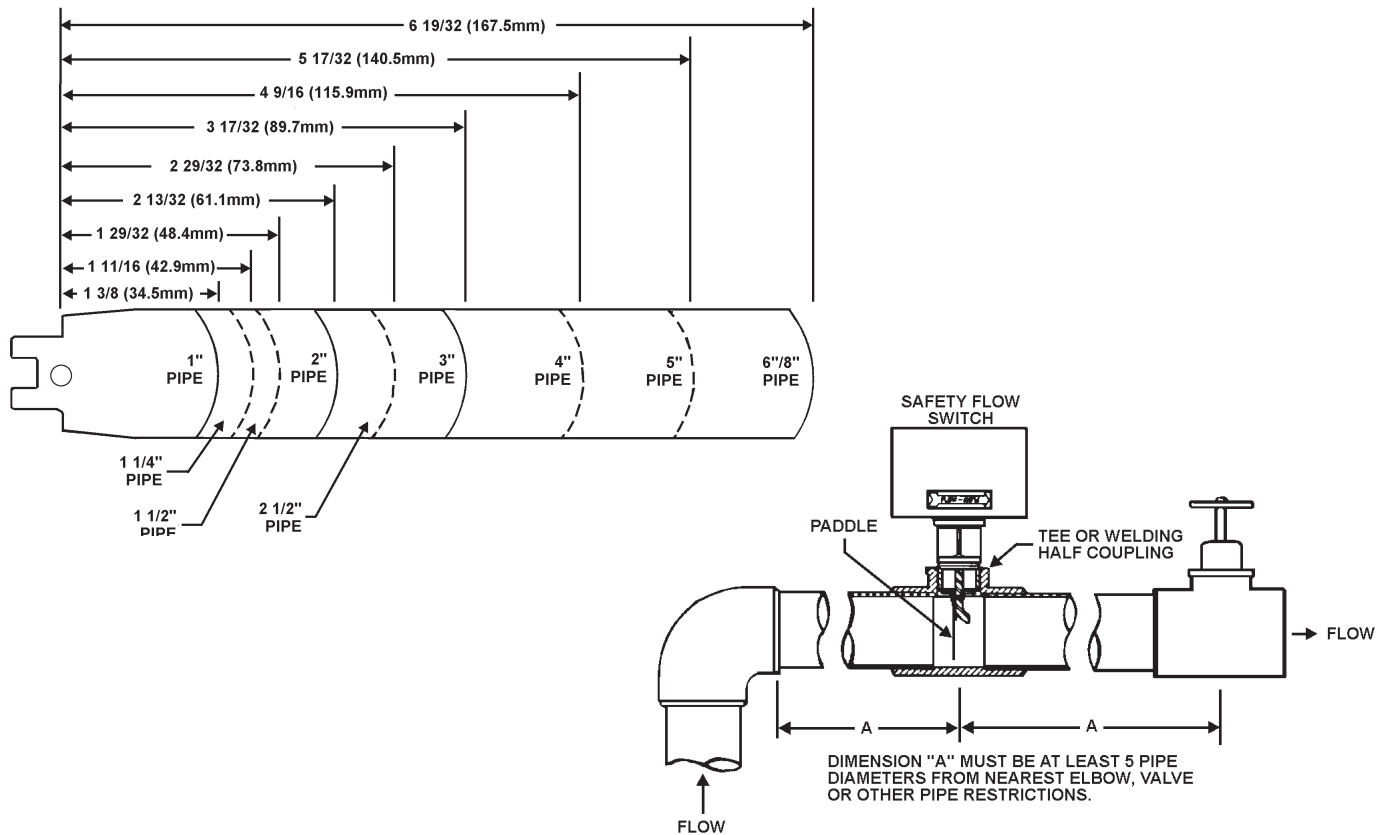

**CAUTION:** The paddle must be trimmed at the dotted arc. It must not touch the pipe or any restrictions when installed.

**FIGURE 5**

**CAUTION**

Any part of the paddle must not touch the pipe or any restrictions in the pipe. Screw the flow switch in position so the flat of the paddle is at right angles to the flow. The arrow on the side case must point in the direction of the flow.

The safety flow switch may be field adjusted to obtain higher minimum flow rates than those shown in Table 5.

To adjust the flow rate setting:

1. Remove the flow switch cover.
2. For higher flow rate—turn the range adjusting screw clockwise.
3. For lower flow rate—turn the range adjusting screw counterclockwise.

**CAUTION**

The switch is factory set at approximately the minimum flow rate, see Table 5. It must not be set lower than the factory setting as this may result in the switch failing to return at a “no flow” condition.

4. Replace the flow switch cover.

**TABLE 5 - SAFETY FLOW SWITCH SETTINGS**

Model	Minimum Flow Rate (GPM/LPM)				Pkg. No.
	Contacts (flow) Closed		Contacts (no flow) Open		
	GPM	LPM	GPM	LPM	
HW-120M, 160M	0.6	2.3	0.3	1.1	9005680205
HW-200M	4.2	15.9	2.5	9.5	9005680205
HW-225M	5.8	22.0	3.7	14.0	9005680205

The installer is cautioned to follow the manufacturer’s instructions exactly when inserting this switch into a pipe tee. This is necessary in order to assure positive action of the switch with water flow. Once the minimum flow rate (Table 5) through the heater is reached, the safety flow switch contacts close and consequently, main burner operation is achieved.

**DRAIN VALVE (NOT SUPPLIED)**

A drain valve must be obtained and installed on each heater and tank for draining purposes, see installation diagrams in this manual.

**THERMOMETERS (NOT SUPPLIED)**

Thermometers should be obtained and field installed as shown in the installation diagrams.

Thermometers are installed in the system as a means of detecting a possible liming condition in the heater. An increase of 5°F over the normal temperature rise through the heater is an indication that lime is present. The term “temperature rise” designates the difference between the heater inlet and outlet water temperatures.

An increase of 5°F (3°C) above the recorded temperature rise may signify a liming condition in the coils or heat exchanger. Refer to PREVENTIVE MAINTENANCE section of this manual for deliming instructions.

Record temperature rise at initial start-up for future reference.

# INSTALLATION INSTRUCTIONS

## IMPORTANT

Strict adherence to installation wiring diagrams shown in this manual is required to prevent constant pump operation when the system temperature control is satisfied, otherwise the warranty is void as stipulated under item 2a (6) of the LIMITED WARRANTY.

## REQUIRED ABILITY

INSTALLATION OR SERVICE OF THIS WATER HEATER REQUIRES ABILITY EQUIVALENT TO THAT OF A LICENSED TRADESMAN IN THE FIELD INVOLVED. PLUMBING, AIR SUPPLY, VENTING, GAS SUPPLY AND ELECTRICAL WORK ARE REQUIRED.

## LOCATION

When installing the heater, consideration must be given to proper location. Location selected should be as close to the stack or chimney as practicable with adequate air supply, and as centralized with piping system as possible.

THE HEATER SHOULD NOT BE LOCATED IN AN AREA WHERE IT WILL BE SUBJECT TO FREEZING.

LOCATE IT NEAR A FLOOR DRAIN. THE HEATER SHOULD BE LOCATED IN AN AREA WHERE LEAKAGE FROM THE HEATER OR CONNECTIONS WILL NOT RESULT IN DAMAGE TO THE ADJACENT AREA OR TO LOWER FLOORS OF THE STRUCTURE.

WHEN SUCH LOCATIONS CANNOT BE AVOIDED, A SUITABLE DRAIN PAN SHOULD BE INSTALLED UNDER THE HEATER. Such pans should be fabricated with sides at least 2" (50.8mm) deep, with length and width at least 2" (50.8mm) greater than the diameter of the heater and must be piped to an adequate drain. The pan must not restrict combustion air flow.

Should the heater be installed in a garage, the heater must be located, or protected, so it is not subject to physical damage by a moving vehicle.

For water heater installation in locations with elevations above 2,000 feet (610M), refer to HIGH ALTITUDE INSTALLATIONS section of this manual for input reduction procedure.

## INSTALLATION CLEARANCES

These units are approved for installation in an alcove having minimum clearances from combustible construction of 44" (1,118mm) from top of the jacket, 6" (152.4mm) from sides, and 6" (152.4mm) from rear and vent connections.

All models may be installed on combustible flooring.

DO NOT INSTALL THIS WATER HEATER DIRECTLY ON A CARPETED FLOOR. A FIRE HAZARD MAY RESULT. Instead the water heater must be placed on a metal or wood panel extending beyond the full width and depth by at least 3 inches (76.2mm) in any direction. If the heater is installed in a carpeted alcove, the entire floor shall be covered by the panel. Also, see the DRAIN REQUIREMENTS.

It is recommended that at least 24" (610mm) be provided on the left side and front of the unit for accessibility and proper servicing. In a utility room installation, the door shall be wide enough to allow the heater to enter or to permit the replacement of another appliance.

## LEVELLING

Each unit should be checked after installation to be certain that it is level.

If the unit is not level, obtain and insert metal shims under the base ring of the unit to correct this condition.

## AIR REQUIREMENTS

### UNCONFINED SPACE

In buildings of conventional frame, brick, or stone construction, unconfined spaces may provide adequate air for combustion, ventilation and draft hood dilution.

If the unconfined space is within a building of tight construction (buildings using the following construction: weather stripping, heavy insulation, caulking, vapor barrier, etc.), air for combustion, ventilation, and draft hood dilution must be obtained from outdoors. The installation instructions for confined spaces in tightly constructed buildings must be followed to ensure adequate air supply.

<b>⚠ DANGER</b>	
	<b>Fire Explosion Hazard</b>
	There is a risk of fire or explosion in areas where gasoline, other flammable liquids, or engine driven equipment and vehicles are stored, operated, or repaired when a fuel burning appliance such as a water heater is operated. Flammable vapors are heavy and travel along the floor. They may be ignited by sparks causing fire or explosion.

	<b>⚠ WARNING</b>
	<b>Fire Hazard</b>
Flammable items, pressurized containers, or any other potential fire hazardous articles must never be placed on or adjacent to the water heater. Open containers or flammable material should not be stored or used in the same room with the water heater.	

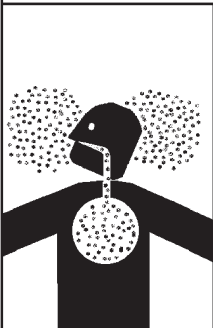
<b>⚠ WARNING</b>	
<b>Carbon Monoxide Gas</b>	
	For safe operation, an ample supply of air must be provided for proper combustion and ventilation in accordance with the National Fuel Gas Code, ANSI Z223.1/NFPA 54 or the Natural Gas and Propane Installation Code CAN/CSA B149.1 or applicable provisions of local codes. An insufficient supply of air will result in a yellow, luminous burner flame, causing carbon or sooting of the finned heat exchanger and creating a risk of asphyxiation. Do not obstruct the flow of combustion and ventilation air.
	Breathing even small amounts of carbon monoxide can cause brain damage or death. Always read and understand instruction manual.

**CONFINED SPACE**



When drawing combustion and dilution air from inside a conventionally constructed building to a confined space, such a space shall be provided with two permanent openings, ONE IN OR WITHIN 12 INCHES (30.5cm) OF THE ENCLOSURE TOP AND ONE IN OR WITHIN 12 INCHES (30.5cm) OF THE ENCLOSURE BOTTOM. Each opening shall have a free area of at least one square inch per 1000 Btuh (2,225mm<sup>2</sup>/Kw) of the total input of all appliances in the enclosure, but not less than 100 square inches (645 square cm).

If the confined space is within a building of tight construction, air for combustion, ventilation and draft hood dilution must be obtained from outdoors. When directly communicating with the outdoors or communicating with the outdoors through vertical ducts, two permanent openings, located in the above manner, shall be provided. Each opening shall have a free area of not less than one square inch per 4000 Btuh (8,900mm<sup>2</sup>/Kw) of the total input of all appliances in the enclosure. If horizontal ducts are used, each opening shall have a free area of not less than one square inch per 2000 Btuh (4,450mm<sup>2</sup>/Kw) of the total input of all appliances in the enclosure. For Canadian installations consult CAN/CGA B149.

Where an exhaust fan is installed in the same room with a heater, sufficient openings for air must be provided in the walls. **UNDERSIZED OPENINGS WILL CAUSE AIR TO BE DRAWN INTO THE ROOM THROUGH THE CHIMNEY, CAUSING POOR COMBUSTION. SOOTING MAY RESULT AND RISK OF ASPHYXIATION WILL OCCUR.**

**VENTING**

<b>⚠ CAUTION</b>
<b>Proper Draft</b>
Proper draft must be maintained to ensure correct operation of this unit.

<b>⚠ WARNING</b>		
<b>Fire and Breathing Hazard</b>		
	The instructions in this section on venting the water heater must be followed to avoid choked combustion or recirculation of flue gases. Such conditions cause sooting or risks of fire and asphyxiation.	

In the United States:

Vent sizing, installation and termination shall be in accordance with current edition of the NATIONAL FUEL GAS CODE. ANSI Z223.1.

Remove all soot or other obstructions from chimney which will retard free draft.

1. Install and size the vent pipe as necessary. The connection from the heater to the chimney should be run full size and should have a minimum pitch upward to the chimney of one quarter inch per foot length.

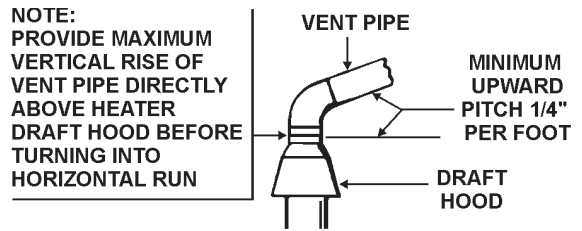

**PROPER VENT PIPE INSTALLATION**  
**FIGURE 6**

Do not install without draft hood and do not install any damper in flueway. Be sure that the vent pipe does not extend beyond the inside wall of the chimney.

2. Where a continuous or intermittent back draft is found to exist, the cause must be determined and corrected. A special vent cap may be required.

**FAILURE TO CORRECT BACK DRAFTS MAY CAUSE AIR CONTAMINATION AND UNSAFE CONDITIONS.**

- If the back draft cannot be corrected by the normal methods or if a suitable draft cannot be obtained, a blower type flue gas exhauster must be employed to assure proper venting and correct combustion.
3. Do not connect the heater to a common flue or chimney with solid fuel burning equipment. This practice is prohibited by many local building codes as is the practice of venting gas fired equipment to the duct work of ventilation systems.
  - Where a separate vent connection is not available and the vent pipe from the heater must be connected to a common flue with an oil burning furnace, the vent pipe should enter the common flue or chimney at a point above the flue pipe from oil furnace.
  4. Where two or more appliances vent into a common vent connector or manifold, the area of the common vent should at least equal the area of the largest flue or vent connector plus 50% of the areas of the additional draft hood outlets.
  5. Refer to the National Fuel Gas Code for information pertaining to multiple heater venting. The ASHRAE HVAC SYSTEMS & EQUIPMENT HANDBOOK, as well as many manufacturers' gas vent and chimney sizing handbooks contain information on multiple heater manifold venting.

**RELIEF VALVE**

An ASME-rated pressure relief valve (Supplied) must be installed in the hot water outlet line as near to the heater as possible. This pressure relief valve is rated in accordance with and complies with the current edition of the ANSI/ASME Boiler and Pressure Vessel Code, Section IV.

A CSA design-certified and ASME-rated temperature and pressure relief valve (Not Supplied) must be installed on each and every water storage tank. This relief valve shall comply with the Standard for Relief Valves for Hot Water Supply systems, "ANSI Z21.22 current edition". This relief valve should have a temperature rating of 210°F (98.8°C), a pressure rating not exceeding the lowest rated working pressure of any system component and a discharge capacity exceeding the total input of the water heaters supplying water to the storage tank.

Select a relief valve with a discharge capacity exceeding the maximum heater input rating and a pressure rating not exceeding the working pressure shown on the rating plate of the heater.

Locate the T & P relief valve in the top of the tank, or in the side of the tank on centerline within the upper 6 inches from the top of the tank. See installation diagrams. Tapping shall be threaded in accordance with the latest version of the Standard for Pipe Threads, General Purpose (inch), ANSI/ASME B1.20.1. Mark location with a Class III label.

Your local code authority may have other specific relief valve requirements not covered in this section.

THE PURPOSE OF A RELIEF VALVE IS TO AVOID EXCESSIVE PRESSURE OR TEMPERATURE INTO THE STEAM RANGE, WHICH MAY CAUSE SCALDING AT FIXTURES, TANK EXPLOSION, SYSTEM OR HEATER DAMAGE.

TO AVOID SCALDING OR WATER DAMAGE, A DRAIN LINE MUST BE CONNECTED TO A RELIEF VALVE TO DIRECT DISCHARGE TO A SAFE LOCATION. A DRAIN LINE MUST NOT BE REDUCED FROM THE SIZE OF THE VALVE OUTLET AND IT MUST NOT CONTAIN ANY VALVES BETWEEN THE HEATER AND THE RELIEF VALVE OR THE RELIEF VALVE AND THE DRAIN LINE EXIT. IN ADDITION, THERE SHOULD NOT BE ANY RESTRICTIONS IN A DRAIN LINE NOR SHOULD IT BE ROUTED THROUGH AREAS WHERE FREEZING CONDITIONS MIGHT OCCUR. DO NOT THREAD OR CAP THE DRAIN LINE EXIT. RESTRICTING OR BLOCKING A DRAIN LINE WILL DEFEAT THE PURPOSE OF THE RELIEF VALVE AND MAY CREATE AN UNSAFE CONDITION. INSTALL A DRAIN LINE WITH A DOWNWARD SLOPE SUCH THAT IT NATURALLY DRAINS ITSELF.

Recommended locations of relief valves are shown in the installation diagrams.

### HARD WATER

Where hard water conditions exist, water softening or the threshold type of water treatment is recommended. This will protect the dishwashers, coffee urns, water heaters, water piping and other equipment. When water softening or water treatment is not practical, a comparatively easy method of periodic lime removal from the heater may be employed by installing gate valves, drain valve and acid fill opening as shown in PREVENTIVE MAINTENANCE section of this manual.

### CLOSED WATER SYSTEMS

Water supply systems may, because of code requirements or such conditions as high line pressure, among others, have installed devices such as pressure reducing valves, check valves, and back flow preventers. Devices such as these cause the water system to be a closed system.

### THERMAL EXPANSION

As water is heated, it expands (thermal expansion). In a closed system the volume of water will grow when it is heated. As the volume of water grows there will be a corresponding increase in water pressure due to thermal expansion. Thermal expansion can cause premature tank failure (leakage). This type of failure is not covered under the limited warranty. Thermal expansion can also cause intermittent Temperature-Pressure Relief Valve operation: water discharged from the valve due to excessive pressure build up. This condition is not covered under the limited warranty. The

Temperature-Pressure Relief Valve is not intended for the constant relief of thermal expansion. A properly sized thermal expansion tank must be installed on all closed systems to control the harmful effects of thermal expansion. Contact a local plumbing service agency to have a thermal expansion tank installed.

### WATER LINE CONNECTIONS

This manual provides detailed installation diagrams for typical methods of application. See piping diagrams.

- Cer-Temp 80 Recovery System (for one temperature water).

These diagrams will serve to provide the installer with a reference for the materials and method of piping necessary for installation. It is essential that all water and gas piping, vent connections, electrical wiring and check and flow regulating valves be installed as shown on the diagrams.

Consult the installation diagrams for appropriate locations to install the safety flow switch(es), drain valves, thermometers, relief valves and the circulating pump(s). Apply suitable pipe thread sealing compounds to only the male threads of parts to be connected. If any of these parts are being replaced in a functioning system, remember to shut off the manual gas and control valve(s) and close off the water inlet(s). Open a nearby faucet to relieve pressure and drain the heater and/or system before attempting to install the new parts.

Check the diagrams thoroughly before starting installation to avoid errors and minimize time and material costs.

If the system is to be filled with water for testing or other purposes during cold weather and before actual operation, care must be taken to prevent a downdraft entering the heater or freezing air from contacting the system. Failure to do so may cause the water in the system to freeze with resulting damage to the system. **Damage due to freezing is not covered by the warranty.**

### WATER (POTABLE) HEATING AND SPACE HEATING

1. All piping components connected to this unit for space heating applications shall be suitable for use with potable water.
2. Toxic chemicals, such as those used for boiler treatment, shall never be introduced into this system.
3. This unit may never be connected to any existing heating system or component(s) previously used with a non-potable water heating appliance.
4. When the system requires water for space heating at temperatures higher than required for domestic water purposes, a tempering valve must be installed. Please refer to installation diagrams on pages 13-15 of this manual for suggested piping arrangements.
5. These water heaters cannot be used in space heating applications only.

# PIPING DIAGRAMS



**⚠ DANGER**

TEMPERATURE SETTING SHOULD NOT EXCEED SAFE USE TEMPERATURE AT FIXTURES. SEE WATER TEMPERATURE CONTROL WARNING ON PAGE 20. IF HIGHER PREHEAT TEMPERATURES ARE NECESSARY TO OBTAIN ADEQUATE BOOSTER OUTPUT, ADD AN ANTI-SCALD VALVE FOR HOT WATER SUPPLIED TO FIXTURES.

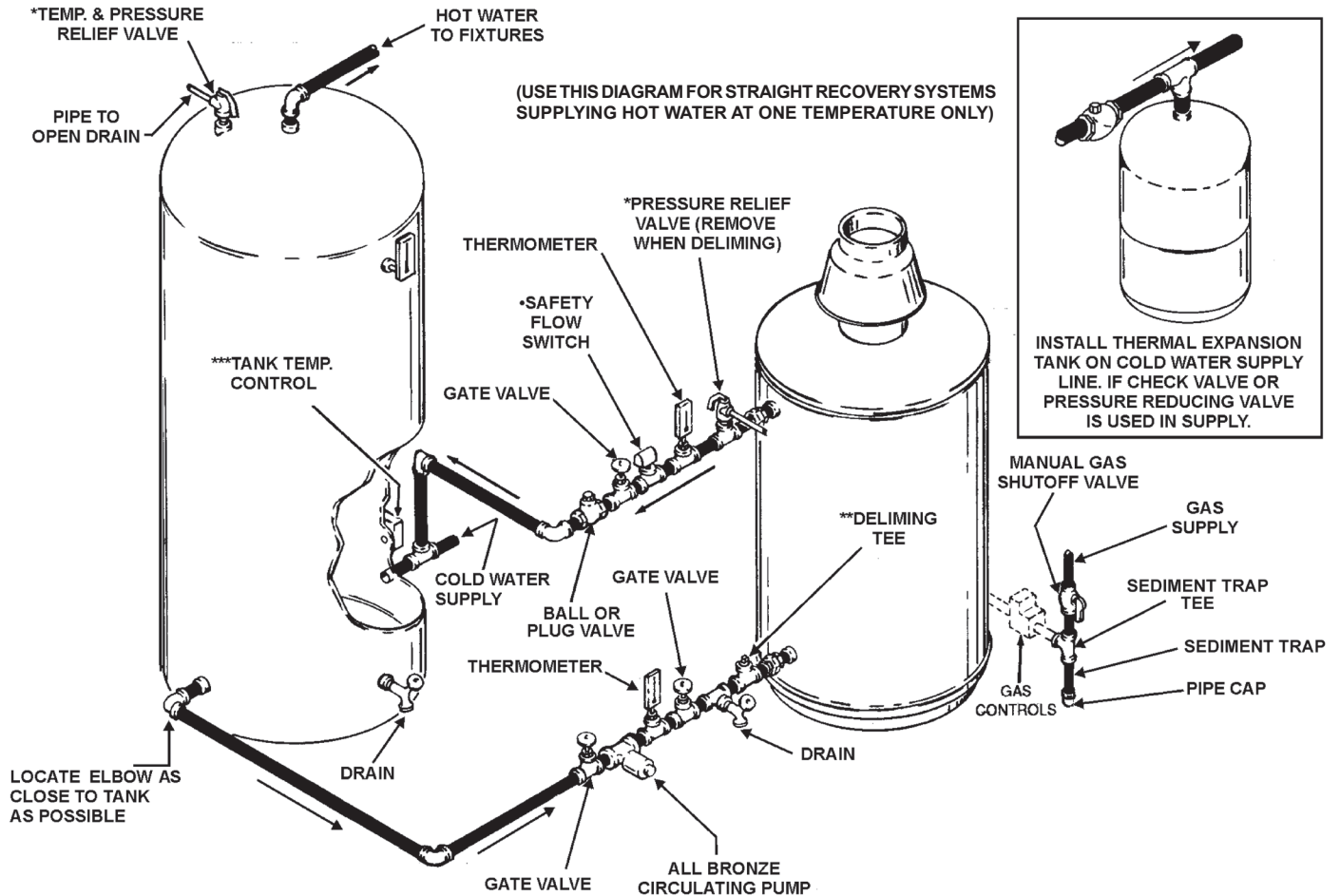

(USE THIS DIAGRAM FOR STRAIGHT RECOVERY SYSTEMS SUPPLYING HOT WATER AT ONE TEMPERATURE ONLY)

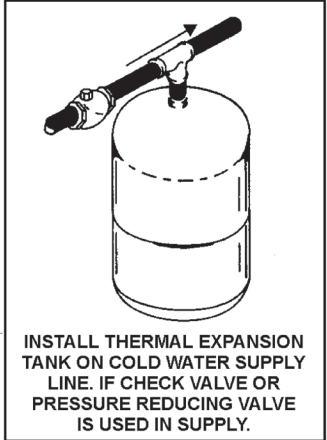

INSTALL THERMAL EXPANSION TANK ON COLD WATER SUPPLY LINE. IF CHECK VALVE OR PRESSURE REDUCING VALVE IS USED IN SUPPLY.

\*PIPE RELIEF VALVE TO OPEN DRAIN. INSTALL IN ACCORDANCE WITH LOCAL CODES.

•IMPORTANT THE INSTALLATION OF THE SAFETY FLOW SWITCH AS SHOWN IS REQUIRED TO PROTECT THE HEATER IN CASE OF WATER SERVICE INTERRUPTION OR CIRCULATOR FAILURE (SEE TABLE 5 FOR A.O.S. PACKAGE NO.)

\*\*ELIMINATION OF DELIMITING FITTING SHOWN MAY MAKE DELIMITING MORE DIFFICULT.

\*\*\* A.O. SMITH MODEL T-140, 200, 350 AND 450 TANKS HAVE TWO TEMPERATURE CONTROL OPENINGS. USE THE LOWER CONTROL OPENING FOR THE TANK TEMPERATURE CONTROL WHEN THE PIPING IS AS SHOWN. USE THE UPPER CONTROL OPENING ONLY WHEN A FLO-PAC FITTING IS USED IN THE WATER OPENING AT THIS LOCATION

**USE THIS TABLE FOR CORRECT PUMP AND PIPE SIZE**

MODEL	MIN. PIPE SIZE	PUMP SIZE
HW-120M	3/4"	"75"
HW-160M	3/4"	"75"
HW-200M	1"	"100"
HW-225M	1-1/4"	"125"

CAUTION: IF BUILDING COLD WATER SUPPLY HAS A BACK-FLOW PREVENTER, CHECK VALVE OR WATER METER WITH CHECK VALVE. PROVISIONS FOR THERMAL EXPANSION OF WATER IN THE HOT WATER SYSTEM MUST BE PROVIDED.

INSTALL IN ACCORDANCE WITH ALL LOCAL CODES.

NOTE: REFER TO PAGES 15 & 16 FOR WIRING DIAGRAMS.

**FIGURE 7**

(USE THIS DIAGRAM FOR STRAIGHT RECOVERY SYSTEMS SUPPLYING HOT WATER AT ONE TEMPERATURE ONLY)

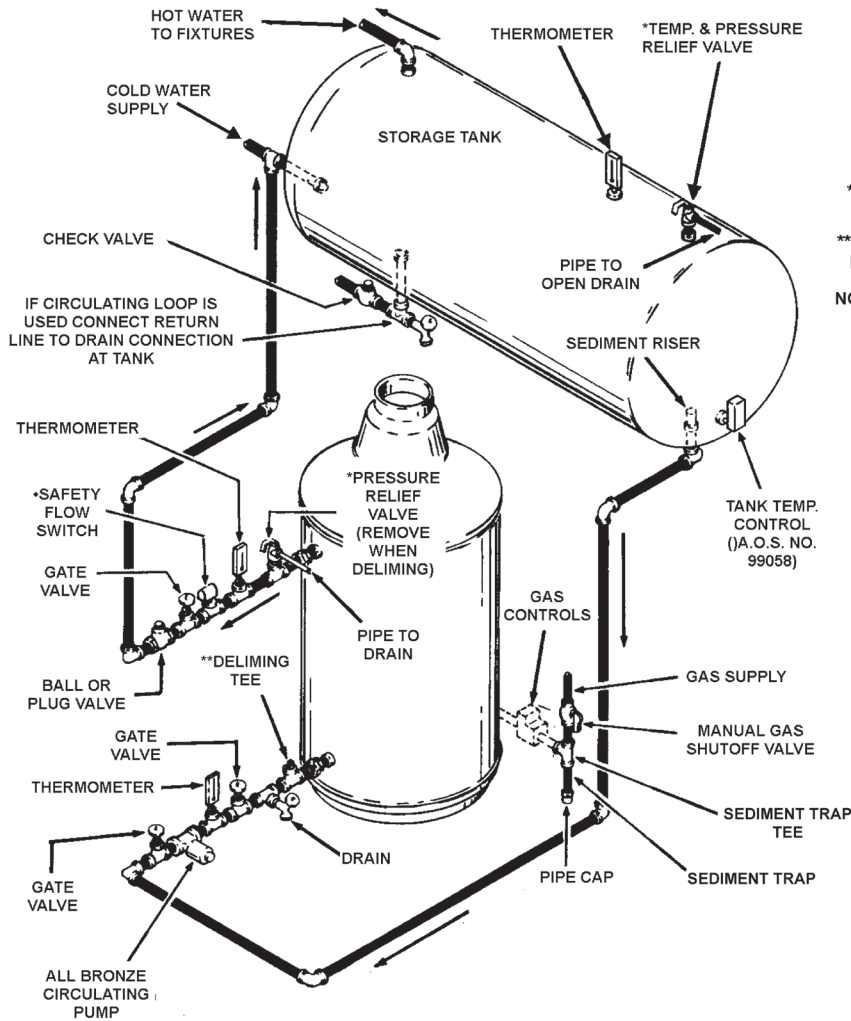

• **IMPORTANT**  
 THE INSTALLATION OF THE SAFETY FLOW SWITCH AS SHOWN IS REQUIRED TO PROTECT THE HEATER IN CASE OF WATER SERVICE INTERRUPTION OR CIRCULATOR FAILURE (SEE TABLE 5 FOR A.O.S. PKG. NO. CAUTION: IF BUILDING COLD WATER SUPPLY HAS A BACK-FLOW PREVENTER, CHECK VALVE OR WATER METER WITH CHECK VALVE. PROVISIONS FOR THERMAL EXPANSION OF WATER IN THE HOT WATER SYSTEM MUST BE PROVIDED.

\*PIPE RELIEF VALVE TO OPEN DRAIN. INSTALL IN ACCORDANCE WITH LOCAL CODES.

\*\*ELIMINATION OF DELIMITING FITTING SHOWN MAY MAKE DELIMITING MORE DIFFICULT.

NOTE: REFER TO PAGES 17 AND 18 FOR WIRING DIAGRAMS

**⚠ DANGER**

TEMPERATURE SETTING SHOULD NOT EXCEED SAFE USE TEMPERATURE AT FIXTURES. SEE WATER TEMPERATURE CONTROL WARNING ON PAGE 20. IF HIGHER PREHEAT TEMPERATURES ARE NECESSARY TO OBTAIN ADEQUATE BOOSTER OUTPUT, ADD AN ANTI-SCALD VALVE FOR HOT WATER SUPPLIED TO FIXTURES.

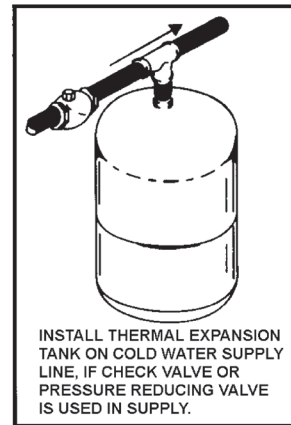

INSTALL IN ACCORDANCE WITH ALL LOCAL CODES.

WIRING  
 ————— BY FACTORY  
 - - - - - BY INSTALLER

USE THIS TABLE FOR CORRECT PUMP AND PIPE SIZE

MODEL	MIN. PIPE SIZE	PUMP SIZE
HW-120M	3/4"	"75"
HW-160M	3/4"	"75"
HW-200M	1"	"100"
HW-225M	1-1/4"	"125"

FIGURE 8

**TWO VERTICAL TANK INSTALLATION**

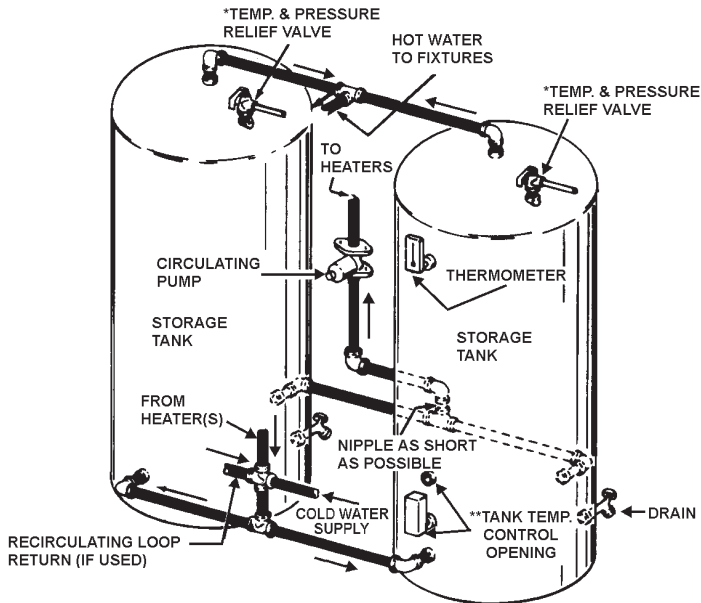

NOTE: CIRCULATING PUMP AND PIPE SIZES TO BE SELECTED FROM THE CER-TEMP 80 DIAGRAM FOR THE MODEL HEATER TO BE INSTALLED.

ALL PIPING FROM TEES TO BE EQUIDISTANT TO TANKS.

\*PIPE ALL RELIEF VALVES TO AN OPEN DRAIN. PRESSURE RELIEF VALVE RATING SHOULD NOT EXCEED PRESSURE CAPACITY OF ANY COMPONENT IN THE SYSTEM.

\*\*A.O. SMITH MODEL T-140, 200, 350 AND 450 TANKS HAVE TWO TEMPERATURE CONTROL OPENINGS. USE THE LOWER OPENING FOR THE TANK TEMPERATURE CONTROL WHEN THE PIPING IS AS SHOWN. DO NOT USE THE UPPER CONTROL OPENING.

**⚠ DANGER**

TEMPERATURE SETTING SHOULD NOT EXCEED SAFE USE TEMPERATURE AT FIXTURES. SEE WATER TEMPERATURE CONTROL WARNING ON PAGE 21. IF HIGHER PREHEAT TEMPERATURES ARE NECESSARY TO OBTAIN ADEQUATE BOOSTER OUTPUT, ADD AN ANTI-SCALD VALVE FOR HOT WATER SUPPLIED TO FIXTURES.

**THREE VERTICAL TANK INSTALLATION**

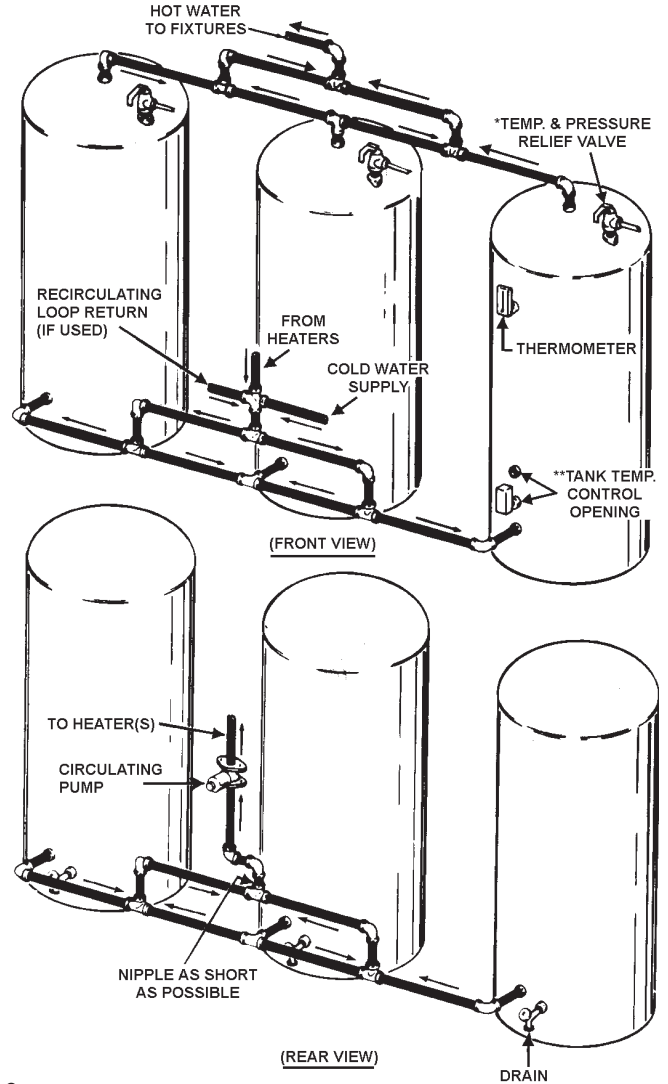

**FIGURE 9**

## GAS CONNECTIONS



### WARNING

THE INLET GAS PRESSURE MUST NOT EXCEED THE VALUE SPECIFIED BY THE MANUFACTURER ON THE RATING PLATE (10.5" W.C. - NATURAL GAS, 13.0" W.C. - PROPANE GAS). EXPOSURE TO HIGHER GAS SUPPLY PRESSURE MAY CAUSE DAMAGE TO THE GAS VALVE WHICH COULD RESULT IN FIRE OR EXPLOSION. IF OVERPRESSURE HAS OCCURRED SUCH AS THROUGH IMPROPER TESTING OF GAS LINES OR EMERGENCY MALFUNCTION OF THE SUPPLY SYSTEM, THE GAS VALVE MUST BE CHECKED FOR SAFE OPERATION. MAKE SURE THAT THE OUTSIDE VENTS ON THE SUPPLY REGULATORS AND THE SAFETY VENT VALVES ARE PROTECTED AGAINST BLOCKAGE. THESE ARE PARTS OF THE GAS SUPPLY SYSTEM, NOT THE HEATER. VENT BLOCKAGE MAY OCCUR DURING ICE STORMS.

IT IS IMPORTANT TO GUARD AGAINST GAS VALVE FOULING FROM CONTAMINANTS IN THE GAS WAYS. SUCH FOULING MAY CAUSE IMPROPER OPERATION, FIRE OR EXPLOSION.

IF COPPER SUPPLY LINES ARE USED THEY MUST BE INTERNALLY TINNED AND CERTIFIED FOR GAS SERVICE.

BEFORE ATTACHING THE GAS LINE BE SURE THAT ALL GAS PIPE IS CLEAN ON THE INSIDE.

TO TRAP ANY DIRT OR FOREIGN MATERIAL IN THE GAS SUPPLY LINE, A SEDIMENT TRAP MUST BE INCORPORATED IN THE PIPING. SEE PIPING DIAGRAMS. THE SEDIMENT TRAP MUST BE READILY ACCESSIBLE AND NOT SUBJECT TO FREEZING CONDITIONS. INSTALL IN ACCORDANCE WITH THE CURRENT EDITION OF ANSI Z223.1 OF THE NATIONAL FUEL GAS CODE.

To prevent damage, care must be taken not to apply too much torque when attaching gas supply pipe to gas valve gas inlet.

Fittings and unions in the gas line must be metal to metal type.

Apply joint compounds (pipe dope) sparingly and only to the male threads of pipe joints. Do not apply compound to the first two threads. Use compounds resistant to the action of liquefied petroleum gases.

BEFORE PLACING THE HEATER IN OPERATION, CHECK FOR GAS LEAKAGE. Use soap and water solution or other material acceptable for the purpose in locating gas leaks.

DO NOT USE MATCHES, CANDLES, FLAME OR OTHER SOURCES OF IGNITION FOR THIS PURPOSE.

DISCONNECT THE HEATER AND ITS MANUAL GAS SHUTOFF VALVE FROM THE GAS SUPPLY PIPING SYSTEM DURING ANY PRESSURE TESTING OF THAT SYSTEM AT TEST PRESSURES IN EXCESS OF 1/2 PSIG. THE GAS SUPPLY LINE MUST BE CAPPED WHEN NOT CONNECTED TO HEATER.

THE HEATER MUST BE ISOLATED FROM THE GAS SUPPLY PIPING SYSTEM BY CLOSING ITS MANUAL GAS SHUTOFF VALVE DURING ANY PRESSURE TESTING OF THE GAS SUPPLY PIPING SYSTEM AT TEST PRESSURES EQUAL TO OR LESS THAN 1/2 PSIG (3.44kPa).

### CORRECT GAS

MAKE SURE the gas on which the heater will operate is the same as that specified on the heater model and rating plate. Do not install the heater if equipped for a different type gas - contact the heater supplier.

### SIZING GAS SUPPLY LINE

The iron pipe or equivalent pipe sizes in Table 6 are derived from Table C-3 in the NATIONAL FUEL GAS CODE. The pipe sizes are based on a supply line gas pressure drop of 0.3 inches of water column from the gas meter to the point of installation of the heater(s). For natural gas, a heating value of 1050 Btu/ft<sup>3</sup> and a specific gravity of 0.60 has been assumed. A heating value of 2500 Btu/ft<sup>3</sup> and a specific gravity of 1.53 has been assumed for L.P. (propane) gas.

Where it is necessary to use an excess number of pipe fittings, i.e., elbows, tees and valves, in the gas supply line, use pipe at least one size larger than that recommended in Table 6 to compensate for the increased pressure drop.

If the service pressure is 4.5 inches W.C. (1.12kPa) for natural gas or (11 inches (1.74kPa) for L.P. gas) of water column or less, use pipe size larger than specified in Table 6 to minimize pressure drop in the line.

### GAS METER SIZE - City Gases Only

Be sure that the gas meter has sufficient capacity to supply the full rated gas input of the heater as well as the requirements of all other gas fired equipment supplied by the meter. If gas meter is too small, ask the gas company to install a larger meter having adequate capacity.

TABLE 6							
GAS SUPPLY PIPE SIZES (IN INCHES)							
Distance To Heater From Meter (FT./M)	NATURAL GAS (1050 Btu/ft <sup>3</sup> )				PROPANE GAS (2500 Btu/ft <sup>3</sup> )		
	HW-120M	HW-160M	HW-200M	HW-225M	HW-120M	HW-160M	HW-200M
10 (3M)	1/2	3/4	3/4	3/4	1/2	1/2	1/2
30 (9.1M)	3/4	3/4	1	1	1/2	3/4	3/4
50 (15.2M)	3/4	1	1	1	3/4	3/4	1
80 (24.4M)	1	1	1 1/4	1 1/4	3/4	1	1
100 (30.5M)	1	1 1/4	1 1/4	1 1/4	3/4	1	1
150 (45.7M)	1	1 1/4	1 1/4	1 1/4	1	1	1 1/4
200 (61M)	1 1/4	1 1/4	1 1/4	1 1/2	1	1 1/4	1 1/4



A minimum gas supply pressure of 4.5" W.C. (1.12kPa) for natural gas and 11" W.C. (2.74kPa) for propane gas is required for purposes of input adjustment.

### ELECTRICAL INFORMATION

ALL ELECTRICAL WORK MUST BE INSTALLED IN ACCORDANCE WITH THE NATIONAL ELECTRICAL CODE IN THE UNITED STATES.

The electrical connections must be made so that both the circulator and intermittent ignition device operate simultaneously when the storage tank temperature control calls for heat.

The water heater, when installed, must be electrically grounded in accordance with local codes or, in the absence of local codes, in the United States with the NATIONAL ELECTRICAL CODE, ANSI/NFPA 70.

A screw is provided in the heater junction box for a ground connection.

All piping diagrams include an electrical wiring diagram to assist the installer in properly wiring of the additional components required to assure correct system operation.

Figures 10 show the heater mounted controls as they are wired

when the heater leaves the factory. Using the individual wiring diagrams on the installation diagrams, the installer connects his wiring to terminals in the heater(s) mounted junction box as shown.

All wiring should be done such that the heater(s) will operate in the following manner:

1. When the tank temperature control calls for heat:
  - The circulating pump starts to operate. Once the safety flow switch contacts close, intermittent ignition device is powered and sequence through steps as described for I.I.D. Control Module on Page 6.
2. When the tank temperature control is satisfied:
  - The main burners should stop firing, but the circulating pump should continue to operate for about 2 minutes when equipped with a thermal balancer.
3. When the automatic gas shutoff control or coil protector switch operate (break electric circuit):
  - The main burners should stop firing. Circulating pump should continue to operate.

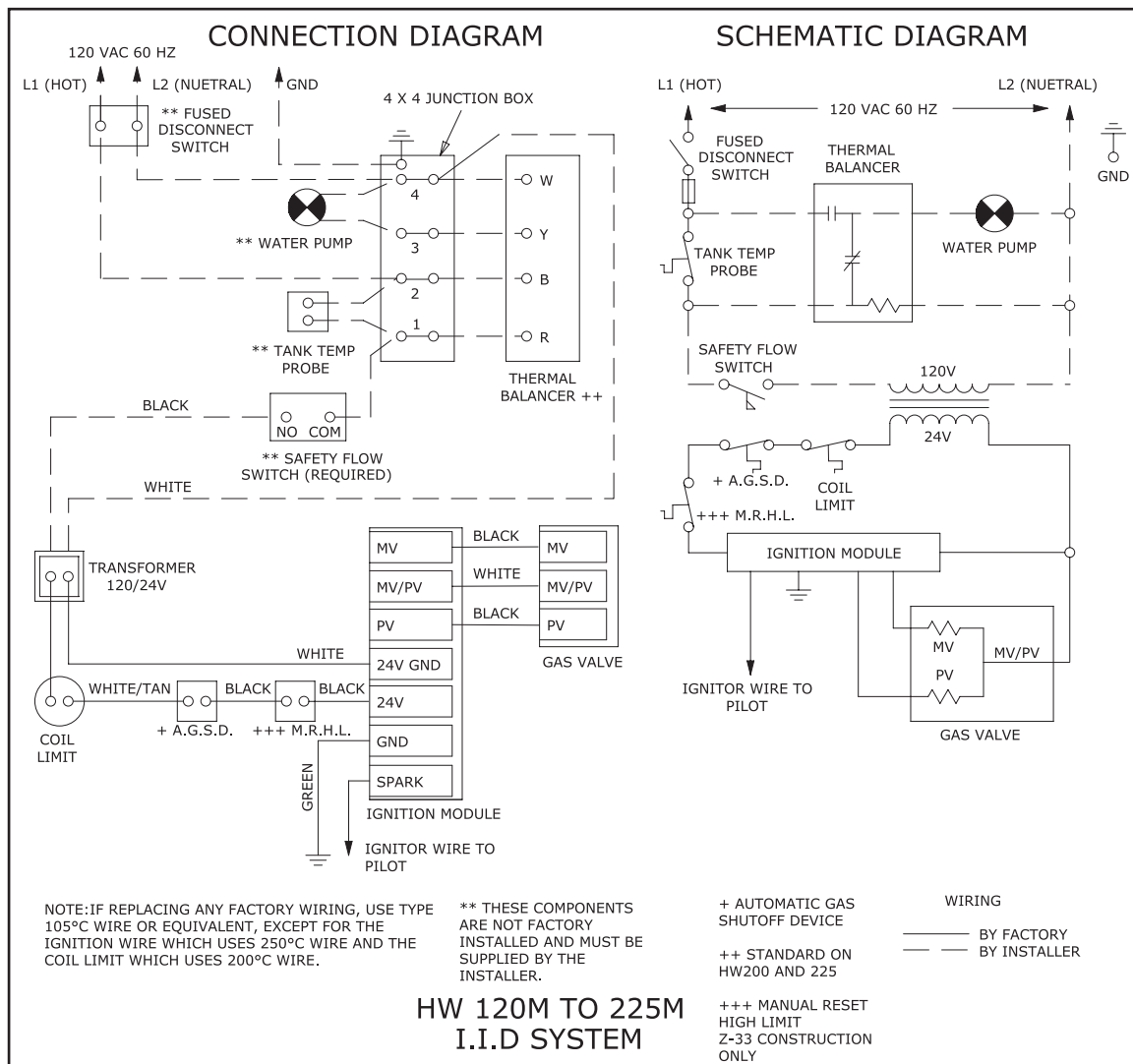

# OPERATION

## IMPORTANT

Only qualified personnel shall perform the initial firing of the heater. At this time the user should not hesitate to ask the start-up technician any questions regarding operation and maintenance of the unit.

Lighting and Operating instructions are included with this manual. By using these instructions, the user may be able to make minor operational adjustments and save unnecessary service calls. However the user should not attempt repairs, but should contact a service technician or gas supplier.

## GENERAL

Never operate the water heater without first making sure the water heater and system are filled with water, in addition:

- Make sure a temperature and pressure relief valve is installed at the water heater and if used, the storage tank. Also check for leaks.
- Also be sure to check the gas piping for leaks before beginning the initial firing of the heater.

## FILLING

1. Close the systems drain valve by turning handle clockwise.
2. Open a nearby hot water faucet to permit the air in the system to escape.
3. Fully open the cold water inlet pipe valve allowing the heater and piping to be filled.
4. Close the hot water faucet as water starts to flow.
5. The heater is ready to be operated.

## GAS LINE LEAK TESTING

	<b>! WARNING</b>
	<b>Fire and Explosion Hazard</b> <ul style="list-style-type: none"><li>• Use joint compound or Teflon tape compatible with propane gas.</li><li>• Leak test before placing the water heater in operation.</li><li>• Disconnect gas piping and main gas shutoff valve before leak testing.</li><li>• Install sediment trap in accordance with NFPA 54.</li></ul>

Any time work is done on the gas supply system perform a leak test to avoid the possibility of fire or explosion.

1. For test pressures exceeding 1/2 psi (3.45 kPa) disconnect the water heater and its Main Gas Shutoff Valve from the gas supply piping system during testing, see Figure 21. The gas supply line must be capped when disconnected from the water heater.
2. For test pressures of 1/2 psi (3.45 kPa) or less, the appliance need not be disconnected, but must be isolated from the supply gas line by closing the Main Gas Shutoff Valve during testing.
3. Coat all supply gas line joints and connections upstream of the water heater with a non-corrosive soap and water solution to test for leaks. Bubbles indicate a gas leak. Do not use matches, candles, flame or other sources of ignition for this purpose.
4. Repair any leaks before placing the water heater in operation.

## PURGING

Gas line purging is required with new piping or systems in which air has entered.

Purging should be performed per the current edition of NFPA 54 the National Fuel Gas Code.

### CAUTION

BEFORE PROCEEDING WITH THE OPERATION OF THE UNIT, MAKE SURE HEATER AND SYSTEM ARE FILLED WITH WATER AND ALL AIR IS EXPELLED FROM HEATER AND PIPING.

THE MAIN MANUAL GAS SHUTOFF VALVE AND THE PILOT ADJUSTING VALVE (WHEN APPLICABLE) MUST HAVE BEEN CLOSED FOR AT LEAST FIVE (5) MINUTES. THIS WAITING PERIOD IS AN IMPORTANT SAFETY STEP. ITS PURPOSE IS TO PERMIT GAS THAT MIGHT HAVE ACCUMULATED IN THE COMBUSTION CHAMBER TO CLEAR. IF YOU DETECT GAS AT THE END OF THIS PERIOD, DO NOT PROCEED WITH LIGHTING. RECOGNIZE THAT GAS ODOR, EVEN IF IT SEEMS WEAK MAY INDICATE PRESENCE OF ACCUMULATED GAS SOMEPLACE IN THE AREA WITH A RISK OF FIRE OR EXPLOSION. SEE THE FRONT PAGE FOR STEPS TO BE TAKEN.

DO NOT USE THIS HEATER IF ANY PART HAS BEEN UNDER WATER. IMMEDIATELY CALL A QUALIFIED SERVICE TECHNICIAN TO INSPECT THE HEATER AND TO REPLACE ANY PART OF THE CONTROL SYSTEM AND ANY GAS CONTROL WHICH HAS BEEN UNDER WATER.

Light the unit in accordance with the instructions on the lighting label attached to the water heater. These instructions are repeated in the following.

## OPERATING INSTRUCTIONS FOR I.I.D. MODELS

The I.I.D. models have an automatic intermittent spark ignition system, figure 3, mounted on the jacket at the front of the heater which ignites the pilot gas whenever system controls call for heat.

Start the unit in accordance with the instructions on the operating label attached to the heater. These instructions are repeated in the following.

FOR YOUR SAFETY READ BEFORE OPERATING





WARNING: IF YOU DO NOT FOLLOW THESE INSTRUCTIONS EXACTLY A FIRE OR EXPLOSION MAY RESULT CAUSING PROPERTY DAMAGE, PERSONAL INJURY OR LOSS OF LIFE.



<p>A. THIS APPLIANCE IS EQUIPPED WITH AN IGNITION DEVICE WHICH AUTOMATICALLY LIGHTS THE PILOT. DO <b>NOT</b> TRY TO LIGHT THE PILOT BY HAND.</p> <p>B. <u>BEFORE OPERATING</u> SMELL ALL AROUND THE APPLIANCE AREA FOR GAS. BE SURE TO SMELL NEXT TO THE FLOOR BECAUSE SOME GAS IS HEAVIER THAN AIR AND WILL SETTLE ON THE FLOOR.</p> <p><b>WHAT TO DO IF YOU SMELL GAS</b></p> <ul style="list-style-type: none"> <li>• DO NOT TRY TO LIGHT ANY APPLIANCE.</li> <li>• DO NOT TOUCH ANY ELECTRIC SWITCH DO NOT USE ANY PHONE IN YOUR BUILDING.</li> <li>• IMMEDIATELY CALL YOUR GAS SUPPLIER FROM A NEIGHBOR'S PHONE. FOLLOW THE GAS SUPPLIER'S INSTRUCTIONS.</li> <li>• IF YOU CANNOT REACH YOUR GAS SUPPLIER, CALL THE FIRE DEPARTMENT.</li> </ul>	<p>C. USE ONLY YOUR HAND TO TURN THE GAS CONTROL KNOB. NEVER USE TOOLS. IF THE KNOB WILL NOT TURN BY HAND, DON'T TRY TO REPAIR IT. CALL A QUALIFIED SERVICE TECHNICIAN. FORCE OR ATTEMPTED REPAIR MAY RESULT IN A FIRE OR EXPLOSION.</p> <p>D. DO NOT USE THIS APPLIANCE IF ANY PART HAS BEEN UNDER WATER. IMMEDIATELY CALL A QUALIFIED SERVICE TECHNICIAN TO INSPECT THE APPLIANCE AND TO REPLACE ANY PART OF THE CONTROL SYSTEM AND ANY GAS CONTROL WHICH HAS BEEN UNDER WATER.</p> <p>E. DO NOT OPERATE APPLIANCE UNLESS UNIT IS FILLED WITH WATER AND INLET LINES AFTER FULLY OPEN.</p>
--	---

GAS VALVE CONTROL KNOB

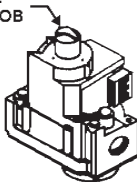
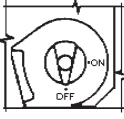
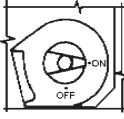

FIGURE "A"







"OFF" POSITION

FIGURE "B"



"ON" POSITION

OPERATING INSTRUCTIONS

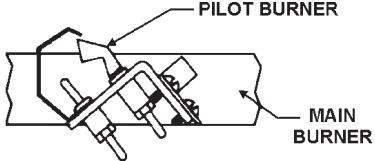
<p>1.  STOP! READ THE SAFETY INFORMATION ABOVE ON THIS LABEL.</p> <p>2. SET THERMOSTAT TO LOWEST SETTING.</p> <p>3. TURN OFF ALL ELECTRIC POWER TO THE APPLIANCE.</p> <p>4. THIS APPLIANCE IS EQUIPPED WITH AN IGNITION DEVICE WHICH AUTOMATICALLY LIGHTS THE PILOT. DO <b>NOT</b> TRY TO LIGHT THE PILOT BY HAND.</p> <p>5. TURN GAS VALVE CONTROL KNOB CLOCKWISE  TO "OFF" (FIG. A) A SLIGHT INDENT CAN BE FELT IN THE "OFF" POSITION.</p> <p>6. WAIT FIVE (5) MINUTES TO CLEAR OUT ANY GAS. THEN SMELL FOR GAS, INCLUDING NEAR THE FLOOR. IF YOU THEN SMELL GAS.</p> <p> STOP! FOLLOW "B" IN THE SAFETY INFORMATION ABOVE IN THIS LABEL. IF YOU DON'T SMELL GAS. GO TO NEXT STEP.</p> <p>7. TURN GAS CONTROL KNOB COUNTERCLOCKWISE  TO "ON" (FIG. B) UNTIL KNOB SNAPS INTO "ON" POSITION.</p>	<p>8. TURN ON ALL ELECTRICAL POWER TO THE APPLIANCE.</p> <p>9. SET THERMOSTAT TO DESIRED SETTING. PILOT WILL BE IGNITED BY ELECTRONIC SPARK. WHEN PILOT IGNITION IS SENSED, THE MAIN BURNERS WILL IGNITE.</p> <p>10. IF MAIN BURNER FAILS TO IGNITE, REMOVE BURNER ACCESS DOOR AND FOLLOW SMALL METAL TUBE FROM GAS VALVE TO PILOT. REPEAT STEPS 2 THRU 9. MAKE SURE PILOT IS BURNING. IF PILOT FAILS TO IGNITE, CHECK FOR PILOT IGNITION SPARK.</p> <p>IF APPLIANCE WILL NOT OPERATE, FOLLOW THE INSTRUCTIONS "TO TURN OFF GAS TO APPLIANCE" AND CALL YOUR SERVICE TECHNICIAN OR GAS SUPPLIER.</p> <div style="text-align: right; margin-top: 20px;">  </div>
--	--

TO TURN OFF GAS TO APPLIANCE

1. SET THE THERMOSTAT TO LOWEST SETTING.
2. TURN OFF ALL ELECTRIC POWER TO THE APPLIANCE IF SERVICE IS TO BE PERFORMED.
3. TURN GAS VALVE CONTROL KNOB CLOCKWISE  TO "OFF". REFER TO STEP 5 OF "OPERATING INSTRUCTIONS" ABOVE.

FIGURE 11

**⚠ DANGER**

HOT WATER TEMPERATURES REQUIRED FOR AUTOMATIC DISHWASHER AND LAUNDRY USE CAN CAUSE SCALD BURNS RESULTING IN SERIOUS PERSONAL INJURY AND/OR DEATH. THE TEMPERATURE AT WHICH INJURY OCCURS VARIES WITH THE PERSON'S AGE AND TIME OF EXPOSURE. THE SLOWER RESPONSE TIME OF CHILDREN, AGED OR DISABLED PERSONS INCREASES THE HAZARDS TO THEM. NEVER ALLOW SMALL CHILDREN TO USE A HOT WATER TAP, OR TO DRAW THEIR OWN BATH WATER. NEVER LEAVE A CHILD OR DISABLED PERSON UNATTENDED IN A BATH TUB OR SHOWER.

THE WATER HEATER SHOULD BE LOCATED IN AN AREA WHERE THE GENERAL PUBLIC DOES NOT HAVE ACCESS TO SET TEMPERATURES.

**⚠ DANGER** Untempered hot water can cause severe burns instantly resulting in severe injury or death.

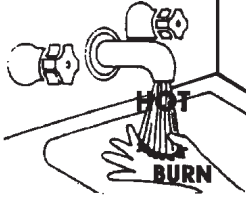

Children, elderly, and the physically or mentally disabled are at highest risk for scald injury.

Feel water before bathing or showering. Temperature limiting valves are available.

Read instruction manual for safe temperature setting.

It is recommended in domestic hot water applications that lower water temperature be used to avoid the risk of scalding. It is further recommended, in all cases, that the water temperature be set for the lowest temperature which satisfies the user's hot water needs. This will also provide the most energy efficient operation of the heater and minimize scale formation in the heat exchanger, thus prolonging the life of the heater.

SETTING THE WATER HEATER TEMPERATURE AT 120°F (49°C) WILL REDUCE THE RISK OF SCALDS. Some states require settings at specific lower temperatures. The table below shows the approximate time-to-burn relationship for normal adult skin.

Water Temperature °F (°C)	Time for 1st Degree Burn (Less Severe Burns)	Time for Permanent Burns 2nd & 3rd Degree (Most Severe Burns)
110 (43)	(normal shower temp.)	
116 (47)	(pain threshold)	
116 (47)	35 minutes	45 minutes
122 (50)	1 minute	5 minutes
131 (55)	5 seconds	25 seconds
140 (60)	2 seconds	5 seconds
149 (65)	1 second	2 seconds
154 (68)	instantaneous	1 second

(U.S. Government Memorandum, C.P.S.C., Peter L. Armstrong, Sept. 15, 1978)

**Table 7**

USE ANTI-SCALD VALVE(S) in the hot water system to reduce the risks of scalding at points of use such as lavatories, sinks and bathing facilities.

**⚠ CAUTION**

IN THE EVENT OF ELECTRIC POWER FAILURE, DO NOT ATTEMPT TO OPERATE THE HEATER.

**CHECKING AND ADJUSTING THE INPUT**

The maximum inlet gas pressure must not exceed the value specified by the manufacturer (10.5" W.C. - natural gas, 13.0" W.C. - propane gas). The minimum value listed on the Rating Plate is for the purposes of input adjustment.

1. Turn the gas valve control knob to "OFF", (See page 19).
2. Attach a pressure gauge or a manometer to the outlet pressure tap, figure 13 and refer to table 3 for correct manifold pressure.
3. Fire the heater by turning the gas valve control knob to "ON".
4. Use this formula to "clock" the meter. Be sure that other gas consuming appliances are not operating during this interval.

$$\frac{3600}{T} \times H = \text{Btuh}$$

T = Time (in seconds) to burn one cubic foot of gas.

H = Heating value of gas (in Btu's per cubic foot of gas).

Btuh = Actual heater input (in Btuh).

EXAMPLE: (Using HW-120M heater)

$$T = 31.5 \text{ seconds/ft}^3$$

$$H = 1050 \text{ Btu/ft}^3$$

$$\text{Btuh} = ?$$

$$\frac{3600}{31.5} \times 1050 = 120,000 \text{ (compare with ratings in Table 2).}$$

Should it be necessary to adjust the gas pressure to the burners to obtain the full input rate, the steps below should be followed.

5. Remove the regulator adjustment sealing cap, fig. 13, and adjust the pressure by turning the adjusting screw with a screwdriver.
  - Clockwise ↻ to increase gas pressure and input rate.
  - Counterclockwise ↺ to decrease gas pressure and input rate.

DO NOT turn the adjusting screw in past the point of little or no manifold pressure change or fully bottom the adjusting screw.

6. "Clock" the meter as in step 4 above.
7. Repeat steps 5 and 6 until the specified input rate is achieved.
8. Turn the gas valve control knob to "OFF". Replace the regulator adjustment sealing cap and remove the pressure gauge or manometer from the outlet pressure tap. Using an allen wrench, replace the set screw in the outlet pressure tap.

9. Turn the gas valve control knob to "ON".

If gas pressure regulator cannot be equipped to give the full input rating with sufficient gas pressure at the valve, contact A.O. Smith Technical Services.

**IMPORTANT**

UNDER NO CIRCUMSTANCES SHOULD THE GAS INPUT EXCEED THE INPUT SHOWN IN TABLE 2. OVERFIRING COULD RESULT IN DAMAGE OR SOOTING OF THE HEATER.

When the heater is operating at full capacity, or full gas input, it should consume 1 cu. ft. of gas in approximately the amount of time indicated in table 8.

**TABLE 8 — TIME REQUIRED TO CONSUME 1 CUBIC FT. OF GAS**

(Heater operating at full input or full capacity. Does not apply to high altitude installations.)

Type of Gas	Heating Value (Btu/Cu. Ft.)	Total Time Required (Seconds)			
		MODEL			
		HW-120M	HW-160M	HW-200M	HW-225M
Natural	1050	31.5	23.6	19.0	16.8
Propane	2500	78.3	56.3	45.2	---

# SERVICE INFORMATION

The installer may be able to observe and correct certain problems which may arise when the unit is put into operation. HOWEVER, it is recommended that only qualified service personnel, using appropriate test equipment, be allowed to service the heater.

Any safety devices used in conjunction with this water heater should receive periodic (at least twice a year) inspection to assure proper operation. All relief valves should be inspected and manually operated every six months.

## PILOT AND MAIN BURNER MAINTENANCE

At least twice a year, check the pilot burner, fig. 14 and the main burners, fig 12, for proper operation.

The burners should display the following characteristics:

- Provide complete combustion of gas.
- Cause rapid ignition and carryover of flame across entire burner.
- Give reasonably quiet operation during ignition, burning and extinction.
- Cause no excessive lifting of flame from burner ports.

If the preceding burner characteristics are not evident, check for accumulation of lint or other foreign material that restricts or blocks the air openings to the burners or heater.

Also check for good flow of combustion and ventilating air to the unit. Maintain a clear area around the heater at all times.

Qualified servicers should follow this procedure when the heater's burners need cleaning.

1. Turn off the electrical power and close the main manual gas shutoff valve.
  - Allow heater parts to cool before disassembly.
2. Remove main burner manifold assembly from heater.
  - Refer to parts list supplied with this manual for disassembly aid.
3. Remove any loose foreign material such as dust or lint with a vacuum. Check all ports, orifices and air openings for blockage. Dislodge any foreign material causing blockage. Do not use sharp metal objects to clean blocked orifices as they will damage the soft brass orifice. Remove any soot or carbon deposits with a rag making sure to remove any lint left on burner by vacuuming again.

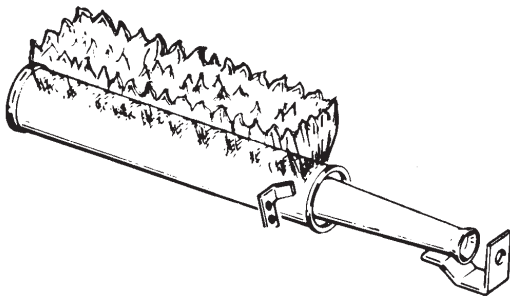

**MAIN BURNER FOR HW HEATERS  
FIGURE 12**

4. Reinstall the burner manifold assembly on heater.

5. Restore electrical power and gas supply to heater.

6. Check for gas leaks and proper heater and vent operation.

## I.I.D. PILOT BURNER

7. Servicing of the pilot burner includes cleaning the burner head and the orifice of the pilot burner, fig. 14.

8. The pilot flame should envelop 3/8 to 1/2 in. of the tip of the insulated rod on the igniter-sensor. If adjustment is required, it is necessary to establish pilot flame without main burner operation. For this to happen, perform the following steps.

1. Follow "TO TURN OFF GAS TO APPLIANCE" steps in the "OPERATING INSTRUCTIONS FOR I.I.D. MODELS".
2. Carefully disconnect the wire terminal connected to the MV terminal of the S8600/S8610 module, fig. 3.
3. Turn gas valve control knob counterclockwise to "ON".
4. Turn on all electric power to the heater.
5. Set tank temperature control to call for heat. Pilot will operate without the main burners igniting.
6. Remove the pilot adjustment cover screw, fig. 13, and turn the inner adjustment screw clockwise ↻ to decrease or counterclockwise ↻ to increase the pilot flame. Be sure to replace cover screw after adjustment to prevent possible gas leakage.
7. Repeat step 1.
8. Carefully reconnect the MV wire terminal to the S8600/S8610 module. Be sure the terminal is securely connected.
9. Follow "OPERATING INSTRUCTIONS FOR I.I.D. MODELS" to put heater back into operation.

10. If the pilot burner ignites but the main burner fails to light, check for gas flow to the main burner.

11. Check for good terminal connections at the igniter-sensor connector (fig. 14) and at the S8600/S8610 module.

12. For further assistance see Chart 2, "S8600/S8610 INTERMITTENT PILOT SYSTEM TROUBLESHOOTING".

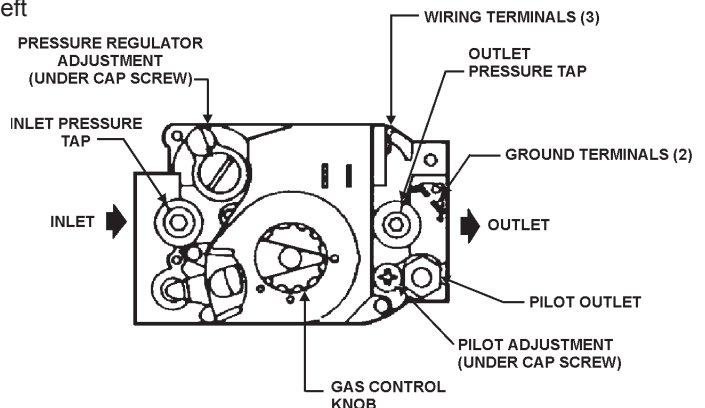

**HONEYWELL GAS VALVE FOR I.I.D. SYSTEM (TOP VIEW)  
FIGURE 13**

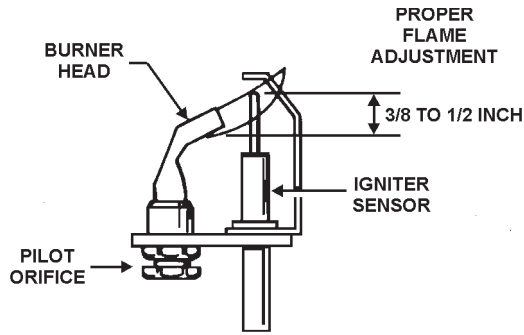

**PILOT BURNER USED ON I.I.D. SYSTEMS**  
**FIGURE 14**

**PROTECTOR SWITCH**  
**(COIL HIGH LIMIT - ALL HEATERS)**

If the protector switch, fig 2, should shut off unit, check for the following conditions:

1. No water in heater.
2. Restricted water flow through the heater.
3. Excessive liming.
4. Improper wiring (automatic gas shutoff control acting as primary control).
5. Pump failure.

After correcting failure condition, remove the protector switch cover and depress reset button. Button will not reset until water temperature in heater coil is down to 200°F. Restart heater, following the "OPERATING INSTRUCTIONS FOR I.I.D. MODELS", PAGE 19.

**PROTECTOR SWITCH CONTINUITY TEST**

Do not depress the protector switch reset button prior to testing. The leads from the switch are removed at the point farthest from the switch.

Attach the leads from a test flashlight to the switch leads.

Check with an Ohm meter.

**TANK TEMPERATURE CONTROL**

The tank temperature control is the primary operating control of the system. The sensing element is mounted on the hot water storage tank. A change of temperature lower than the control setting will cause the element to activate the electrical switch and start the heater.

**AUTOMATIC GAS SHUTOFF CONTROL**

The automatic gas shutoff control, fig. 1, is an automatic device which is wired in series with the gas valve and intermittent ignition control module.

The control settings are fixed at 195°F (90.5°C) cut-out and 190°F (87.7°C) cut-in. Reduced water flow due to lime scale accumulation is one cause of frequent automatic gas shutoff control operations. Refer to "PREVENTIVE MAINTENANCE" section for deliming instructions. If this non-adjustable control is out of calibration, replace control.

**THERMAL BALANCER**

Figure 15 shows the internal wiring of the thermal balancer. The device may be tested after disconnecting the four leads from their respective terminals on the unit.

1. Apply a test light to the yellow and red leads:
  - The lamp should light as the contact in this circuit is normally closed when the resistor is cool.
2. Apply the light to the black and yellow leads.
  - The lamp should not light as the contact in this circuit is normally open when the resistor is cool.
3. Remove the test light.
4. Apply 120 volts to the white and red leads which power the 1900 ohm resistor.
  - After warming period, the contacts of the thermal balancer should change position.
5. Remove the 120 volt power source.
6. Apply the test light as described in steps 1 and 2.
  - While the resistor is still warm, the lamp indications should be the opposite as described above. If this is not the case, replace the thermal balancer.

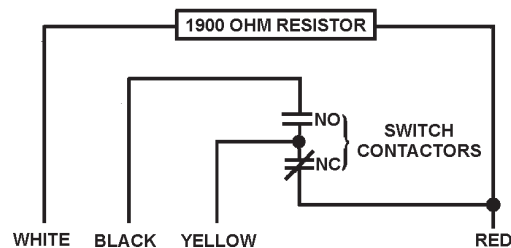

**THERMAL BALANCER SCHEMATIC DIAGRAM**  
**FIGURE 15**

**INPECTING THE HEAT EXCHANGER AND VENTING SYSTEM**

Every 6 months, inspect the venting system (including the chimney) for blockages which will retard free draft and points of flue gas leakage. Remove any obstructions and replace any damaged or deteriorated vent pipe.

Check the heat exchanger to be sure it is not blocked by dirt or soot. It is not sufficient to only look through the flue outlet with the draft hood removed. Examination should also be made using a mirror and light through the burner opening, viewing the entire bottom area of the exchanger.

Qualified servicers should follow this procedure when the heater's external heating surfaces need cleaning.

### CAUTION

DO NOT USE A NYLON BRUSH OR OTHER STATIC CREATING MATERIAL TO CLEAN DUST AND CARBON DEPOSITS FROM HEATING SURFACES AND VENT.

SUCH DEPOSITS ARE FLAMMABLE AND MAY BE IGNITED BY STATIC ELECTRICITY. USE A METAL BRUSH TO MINIMIZE THE DANGER OF EXPLOSION.

1. Turn off the electrical power and main manual gas shutoff valve.
  - Allow heater parts and vent to cool before disassembly.
2. Remove heater draft diverter and vent pipe running to chimney.
  - Check parts and chimney for obstructions and clean as necessary.
  - Replace any damaged or deteriorated parts of the venting system.
3. Remove burners from heater and other metal parts as required to clean and vacuum the heat exchangers and combustion coils.
  - Refer to parts list supplied with this manual for disassembly aid.
4. Reinstall the parts removed in steps 2 and 3.
  - Be sure the vent pipe has a minimum upward pitch of one quarter inch per foot of length and is sealed as necessary.
5. Restore electrical power and gas supply to heater.
  - Check for gas leaks and proper heater and vent operation.

Upon reassembly, a negative draft must be produced by the system. Check for proper draft by holding a lit match near the draft hood opening while the heater is operating. The flame should be drawn into the draft hood opening indicating proper draft.

### **GAS PRESSURE REGULATOR**

The gas pressure regulator is included in the combination gas valve, fig.13, and is set to operate on the gas specified on the heater model and rating plate.

Periodically check main burner, fig. 12, and pilot flame, fig. 14, for proper operation. This should be checked every six months.

Do not subject the gas valve to inlet gas pressure of more than 10.5" W.C. - natural gas, 13.0" W.C. - propane gas. If higher gas pressures are encountered, a service regulator is necessary.

Check for a minimum inlet gas pressure value shown on the Rating Plate before making any adjustment of the regulator.

Attempts to adjust the regulator during periods of low gas supply pressure could result in overfiring of the heater when the gas supply pressure returns to normal.

**DO NOT INCREASE PRESSURE ABOVE THAT SPECIFIED AS OVERFIRING WILL RESULT IN DAMAGE TO THE HEATER**

If gas pressure regulator cannot be adjusted to correct pressure with sufficient gas pressure at the valve, replace with new gas valve.

## **PREVENTIVE MAINTENANCE**

### **RECOMMENDED PROCEDURE FOR PERIODIC REMOVAL OF LIME DEPOSITS FROM COIL TYPE COMMERCIAL WATER HEATERS**

#### CAUTION

Lime accumulation can reduce the life of the equipment, reduce efficiency and waste fuel. Heater failure due to lime or scale buildup voids the warranty.

### **RELIEF VALVE**

At least twice a year the system relief valves should be checked to ensure that they are in operating condition. To check a relief valve, lift the lever at the end of the valve several times. The valve should seat properly and operate freely.

### CAUTION

BEFORE MANUALLY OPERATING A RELIEF VALVE, MAKE SURE THAT A DRAIN LINE HAS BEEN ATTACHED TO THE VALVE TO DIRECT DISCHARGE TO AN OPEN DRAIN. FAILURE TO TAKE THIS PRECAUTION COULD MEAN CONTACT WITH EXTREMELY HOT WATER EXITING THE VALVE DURING THE CHECK OPERATION.

If a relief valve discharges periodically or continuously, it may be due to thermal expansion of water in a closed water supply system, or, it may be due to a faulty relief valve.

Thermal expansion is the normal response of water when it is heated. In a closed system, thermal expansion will cause the system pressure to build until the relief valve actuation pressure is equaled. Then the relief valve will open allowing some water to escape, slightly lowering the pressure.

Installation of a properly sized thermal expansion tank will usually correct this problem. Contact your water supplier or local plumbing inspector for information on how to best correct this situation.

**ABOVE ALL DO NOT PLUG ANY RELIEF VALVE. THIS IS NOT A SOLUTION AND CAN CREATE A HAZARDOUS SITUATION.**

### **CIRCULATING PUMP**

The circulating pump may require occasional lubrication. Refer to circulator manufacturer's instructions for lubrication procedures, and lubrication frequency.

### **ELECTRICAL SERVICE**

#### CAUTION

LABEL ALL WIRES PRIOR TO DISCONNECTION WHEN SERVICING CONTROLS. WIRING ERRORS CAN CAUSE IMPROPER AND DANGEROUS OPERATION.

VERIFY PROPER OPERATION AFTER SERVICING.

### **REPLACEMENT PARTS**

Replacement parts may be ordered through A. O. Smith dealers, authorized servicers or distributors. Refer to the Yellow Pages for where to call or contact the A. O. Smith, 500 Tennessee Waltz Parkway, Ashland City, TN 37015, or on the web at [www.hotwater.com/parts](http://www.hotwater.com/parts). When ordering parts be sure to state the quantity, part number and description of the item including the complete model and serial number as it appears on the product. Refer to the parts list for more information.

The amount of calcium carbonate (lime) released from water is in direct proportion to the water temperature and usage. See Figure 16.

The higher the water temperature or the water usage, the more lime deposits are dropped out of the water. This is the lime scale which forms in pipes, heaters and on cooking utensils.

Lime accumulation not only reduces the life of the equipment, but also reduces efficiency of the heater and increases fuel consumption.

The usage of water softening equipment greatly reduces the hardness of the water. However, this equipment does not always remove all of the hardness (lime). For this reason it is recommended that a regular schedule for delimiting be maintained.

The time between cleaning will vary from weeks to months depending upon water conditions and usage. A change of approximately 5°F in the normal temperature rise through the heater is usually an indication that scale should be removed. For long life, copper or brass is recommended for all valves, pipe and fittings used between gate valves "A" and "B" and the heater, see fig. 17.

Heater failure due to excessive lime build-up voids the warranty

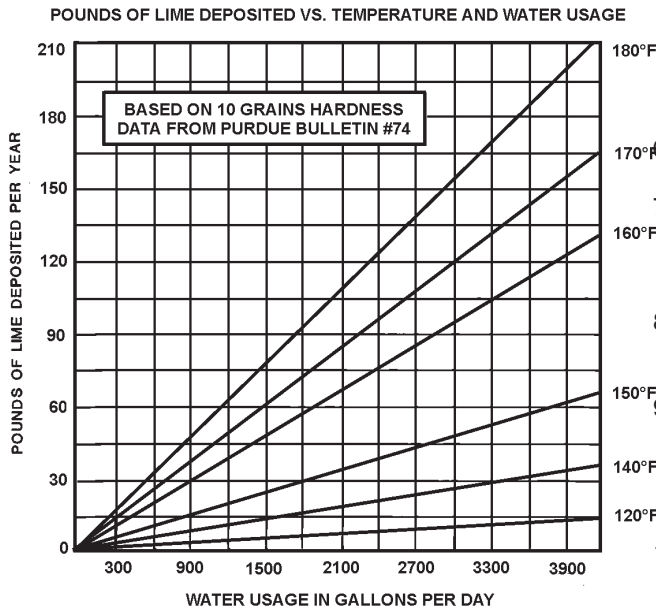

FIGURE 16

### DELIMITING SOLVENTS

A. O. Smith recommends the use of UN•LIME® for delimiting. UN•LIME is a patented food grade acid which is safe to handle and does not create the harmful fumes which are associated with other products.

UN•LIME may be obtained from your dealer, distributor or the A. O. Smith. Order part no. 9005416105 (1 gal.), packed 4 gallons per case, or part no. 9005417105 (5 gal. container).



**CAUTION**

Observe handling instructions on label of product being used.

### REMOVING LIGHT DEPOSITS

1. Shut off electric and gas supply to the burner.
2. Close gate valves "A" and "B".
3. Install drain hose assembly in upper delimiting tee. Open drain cock and drain heater. Install standpipe in lower delimiting tee or in tee from which pressure relief valve has been removed.
4. Close drain valve.
5. Slowly pour 3 gallons of UN•LIME into heater through standpipe. Direct solution into suitable container with a hose, see fig. 17.

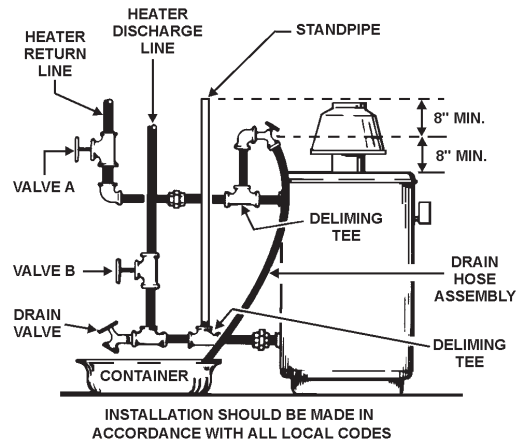

DELIMITING THE HW WATER HEATER  
FIGURE 17

6. Continue to fill until foaming action stops.
7. When foaming action has stopped completely, allow 10 to 15 minutes for UN•LIME to dissolve any remaining scale in the heater.
8. Open the drain valve and drain all UN•LIME from the heater.
9. Remove standpipe and drain hose assembly from tees. Install fittings originally removed into openings. Open valve "A", allowing fresh water to flow through heater and out drain valve for 3 to 5 minutes.
10. Close drain valve and open valve "B". Heater is now ready for operation.

### HEAVY LIME DEPOSITS

If the solvent does not readily pass through the clogged coils or heat exchanger, it will be necessary to use a delimiting pump or contact a service agency for proper cleaning.

A. O. Smith Form No. 4778, entitled "All About Delimiting Coil Type Water Heaters", describes heater cleaning methods and equipment required. UN•LIME and the booklet may be obtained through your dealer, distributor or A. O. Smith.

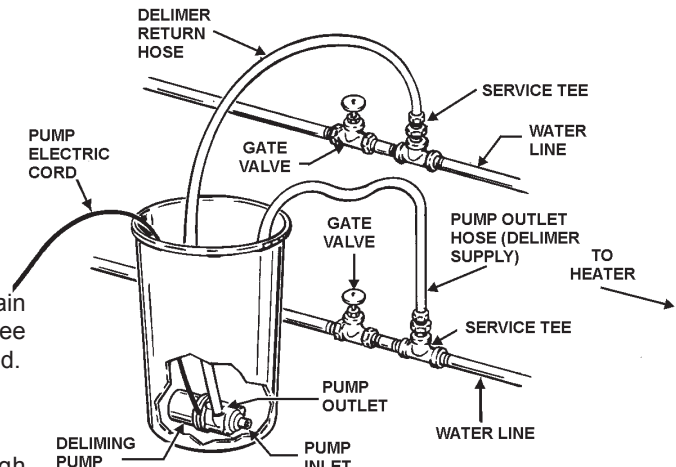

FIGURE 18



# CHECKOUT

The checkout sequence should be used as an on-the-job troubleshooting guide to identify the cause of incorrect system operation and suggest a remedy for its correction.

Because improper piping and wiring can result in unsatisfactory system performance, it is suggested that the installation be

examined before using the checkout procedure. Be sure to refer to the correct piping - wiring diagram and checkout for the type of system that is installed.

The system should be filled with water, purged of air, valves properly set and utilities connected and ready to operate.

**CHART 1 - CER-TEMP 80 RECOVERY SYSTEM CHECKOUT PROCEDURE**

(USE THIS CHECKOUT FOR CER-TEMP 80 RECOVERY SYSTEMS)

Checkout Sequence	SYSTEM OPERATION		Cause	Remedy		
	Contact	Incorrect				
Set tank temperature control 20° (11°C) below tank water temperature	Circulating pump and burner shut off.  With thermal balancer, pump off delay of approximately 2 minutes.	Pump and burner remain on.	Tank temperature control differential wide.	Reduce differential.		
			Tank temperature control defective.	Replace.		
		System wiring is incorrect.	Correct wiring.			
		Circulating pump on.	Pump wired for continuous operation.	Correct wiring.		
		Burner on.	See intermittent pilot system troubleshooting chart 2.			
			Gas valve stuck or defective.	Correct or replace valve.		
System wiring in incorrect.	Correct wiring.					
Set tank temperature control 20° (11°C) above tank water temperature.	Circulating pump and burner on.	Circulating pump on.	Automatic gas shutoff control calibrated too low or differential too wide.	Replace. (If problem proven to be at this control by applying jumper to terminals.)		
			If system has been in extended use it may have lime build-up.	See preventive maintenance.		
			System wiring is incorrect.	Correct wiring.		
			Gas valve or wiring defective.	Check wiring repair or replace valve.		
			See intermittent pilot system trouble-shooting chart 2.			
		Circulating pump and burner off.	Tank temperature control differential too great.	Reduce differential. A 5° differential is generally used.		
			Power off or system wiring is incorrect.	Check power supply and wiring.		
			Tank temperature control defective.	Replace.		
		See intermittent pilot system trouble-shooting chart 2.				
		Burner on.	System wiring is incorrect.	Replace.		
			See intermittent pilot system trouble-shooting chart 2.			
		Heater outlet water temperature exceeds 210°F.	Circulating pump on.	Circulating pump and burner on.	Automatic gas shutoff control defective.	Replace.
					See intermittent pilot system trouble-shooting chart 2.	
		Set tank temperature control for desired water temperature.	System maintains desired water temperature.			

**CHART 2  
S8600/S8610 (NATURAL GAS AND LP GAS)  
INTERMITTENT PILOT SYSTEM TROUBLESHOOTING**

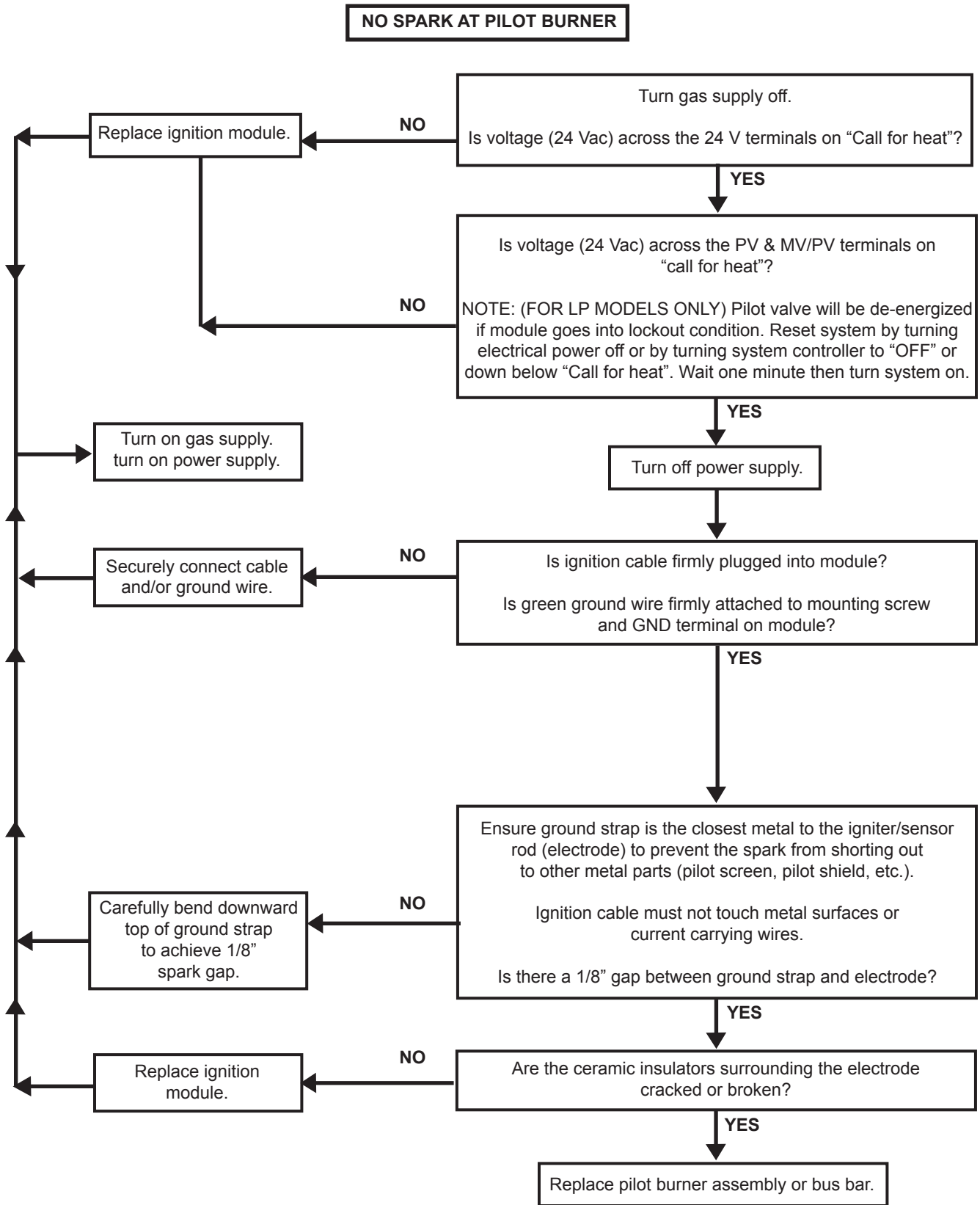

**CHART 2**  
**S8600/S8610 (NATURAL GAS AND LP GAS)**  
**INTERMITTENT PILOT SYSTEM TROUBLESHOOTING**

**SPARK AT PILOT BURNER BUT PILOT WILL NOT LIGHT**

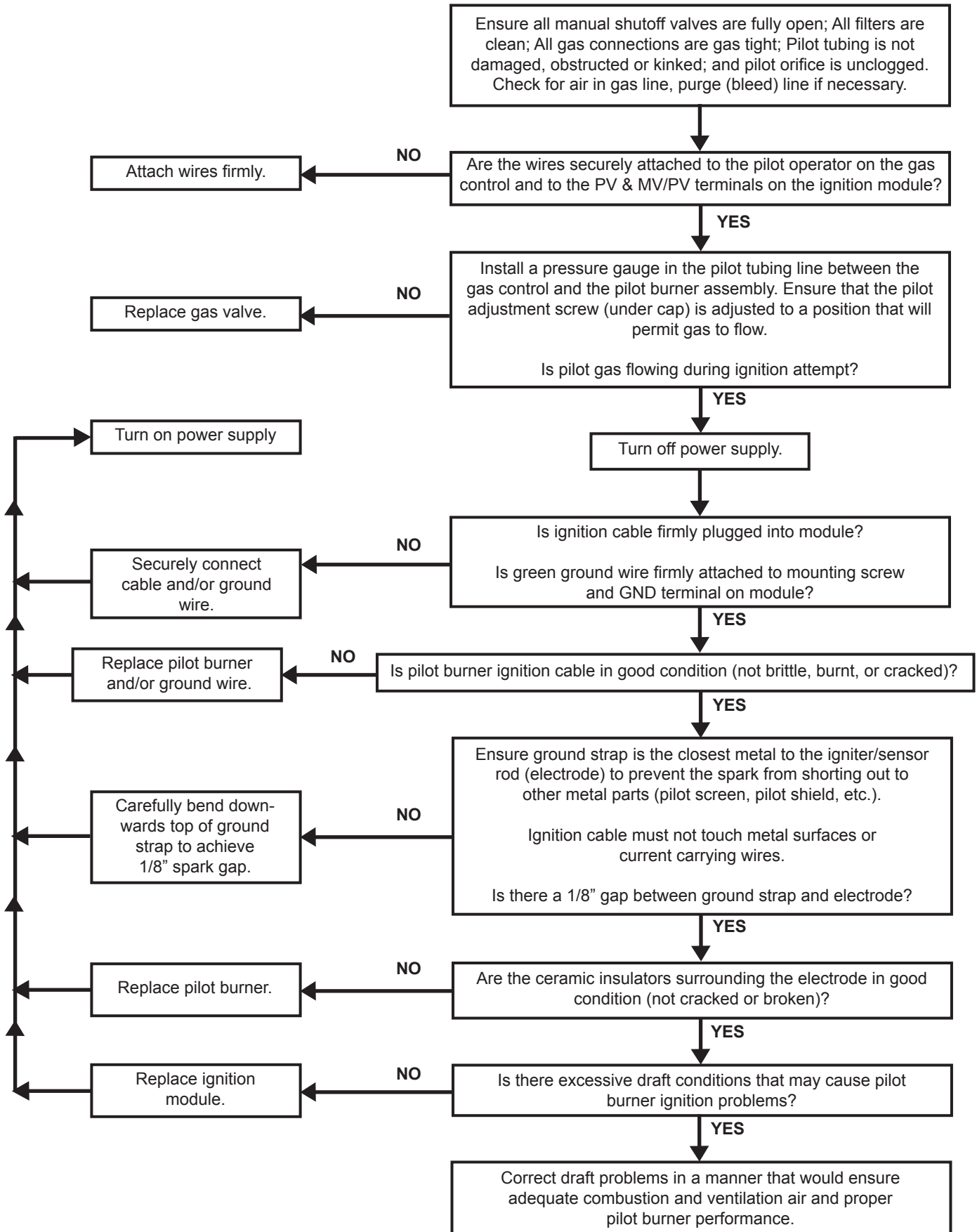

**CHART 2  
S8600/S8610 (NATURAL GAS AND LP GAS)  
INTERMITTENT PILOT SYSTEM TROUBLESHOOTING**

**PILOT BURNER LIGHTS BUT MAIN BURNER DOES NOT LIGHT**

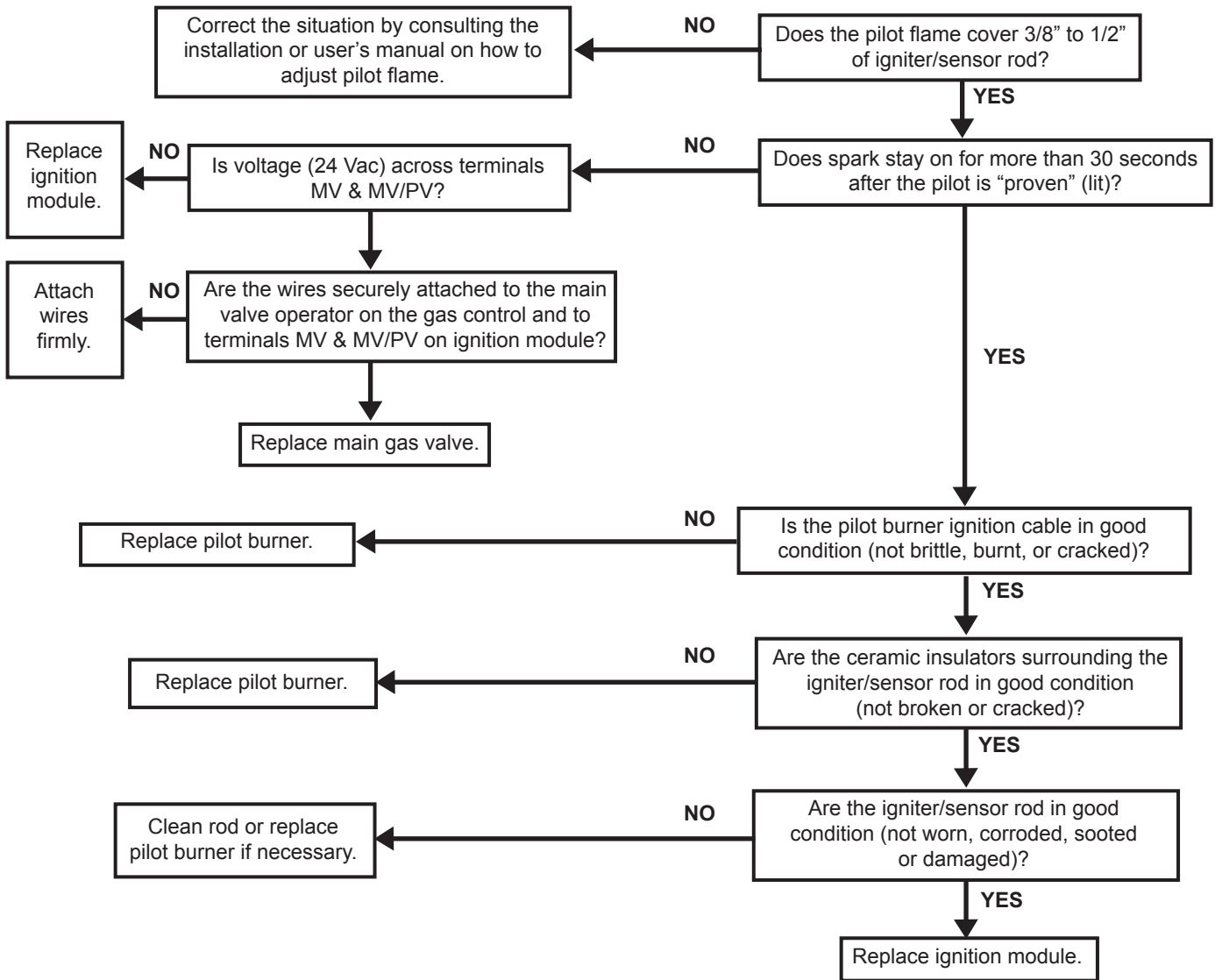

### CHART 3 LED STATUS AND TROUBLE SHOOTING

The following procedures are provided as a general guide. Any module should be replaced if it does not perform properly or checkout on troubleshooting. In addition, replace any module if it is wet or looks like it has ever been wet.

The control has two LEDs; one for flame sensing and one for system status:

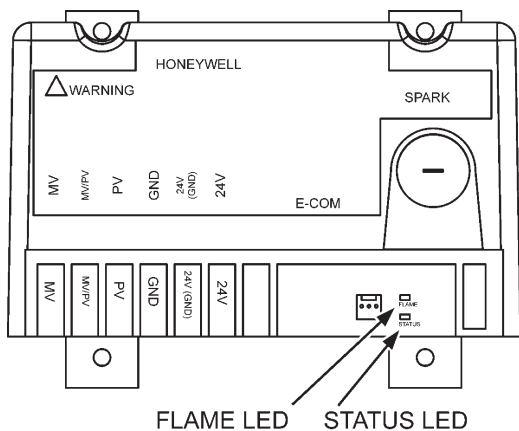

**FIGURE 19. LOCATION OF LEDS.**

- **Flame LED (Yellow)**
  - Indicates flame presence and strength. See Table 6.
- **Status LED (Green)**
  - Indicates system operation status and error conditions. See Table 7 and Table 8 for status specific to each model.
- **<sup>a</sup> Flash Code Descriptions:**
  - Heartbeat: Constant ½ second bright ½ second dim cycles.
  - The flash code number signifies that the LED flashes X times at 2Hz, remains off for two seconds, and then repeats the sequence.

#### YELLOW LED FLAME CODES

Yellow LED Flash Code <sup>a</sup>	Indicates	Recommended Service Action
Heartbeat	Normal Flame Signal	not applicable
2	Weak Flame Signal - System will operate reliably but flame signal is less than desired.  NOTE: This indication may flash temporarily during or shortly after lightoff on some applications.	Perform routine maintenance to assure optimum flame signal.
1	Marginal Flame Signal (less than 1.1µA) - System may not operate reliably over time. Service call recommended.  NOTE: This indication may flash temporarily during or shortly after lightoff on some applications.	Check gas supply, pilot burner, flame sense wiring, contamination of flame rod, burner ground connection.
OFF	No Flame or Flame Signal below minimum threshold for system operation.	not applicable

**CHART 4  
CONTINUOUS RETRY MODEL M - GREEN LED STATUS CODES**

<b>Green LED Flash Code (X + Y)<sup>a</sup></b>	<b>Indicates</b>	<b>Next System Action</b>	<b>Recommended Service Action</b>
OFF	No "Call for Heat"	not applicable	none
Flash Fast	Startup - Flame sense calibration	not applicable	none
Heartbeat	Normal Operation	not applicable	none
2	5 minute Retry Delay -Pilot flame not detected during trial for ignition.	Initiate new trial for ignition after retry delay completed.	If system fails to light on next trial for ignition check gas supply, pilot burner, spark and flame sense wiring, flame rod contaminated or out of position, burner ground connection.
3	Recycle - Flame failed during run.	Initiate new trial for ignition. Flash code will remain through the ignition trial until flame is proved.	If system fails to light on next trial for ignition, check gas supply, pilot burner, flame sense wiring, contamination of flame rod, burner ground connection.
4	Flame sensed out of sequence	If situation self corrects within 10 seconds, control returns to normal sequence. If flame out of sequence remains longer than 10 seconds, control goes to Flash code 6 + 4 (see below).	Check for pilot flame. Replace gas valve if pilot flame present. If no pilot flame, cycle "Call for Heat." If error repeats, replace control.
7	Flame sense leakage to ground	Control remains in wait mode. When the fault corrects, control resumes normal operation after a one minute delay.	Check flame sense lead wire for damage or shorting. Check that flame rod is in proper position. Check flame rod ceramic for cracks, damage or tracking.
8	Low secondary voltage supply - (below 15.5 Vac)	Control remains in wait mode. When the fault corrects, control resumes normal operation after a one minute delay.	Check transformer and AC line for proper input voltage to the control. Check with full system load on the transformer.
6+2	5 minute Retry Delay - On every third retry on the same "Call for Heat"	Initiate new trial for ignition after retry delay completed.	Check gas supply, pilot burner, flame sense wiring, contamination of flame rod, burner ground connection.
6+3	On every 6th flame failure during run on the same "Call for Heat"	5 minute retry delay, then initiate new trial for ignition.	Check gas supply, pilot burner, flame sense wiring, contamination of flame rod, burner ground connection.
6+4	Flame sensed out of sequence - longer than 10 seconds.	Control waits until flame is no longer sensed and then goes to soft lockout. Flash code continues. Control auto resets from soft lockout after one hour.	Check for pilot flame. Replace gas valve if pilot flame present. If no pilot flame, cycle "Call for Heat." If error repeats, replace control.
ON	Soft lockout due to error detected during self check sequences	Control auto resets from soft lockout after one hour.	Reset by cycling "Call for Heat." If error repeats, replace the control.

**<sup>a</sup> Flash Code Descriptions:**

- Flash Fast: rapid blinking.
- Heartbeat: Constant ½ second bright ½ second dim cycles.
- A single flash code number signifies that the LED flashes X times at 2Hz, remains off for two seconds, and then repeats the sequence.
- X + Y flash codes signify that the LED flashes X times at 2Hz, remains off for two seconds, flashes Y times at 2Hz, remains off for three seconds, and then repeats the sequence.

**CHART 5**  
**LOCKOUT MODEL H - GREEN LED STATUS CODES**

Green LED Flash Code (X + Y) <sup>a</sup>	Indicates	Next System Action	Recommended Service Action
OFF	No "Call for Heat"	not applicable	none
Flash Fast	Startup - Flame sense calibration	not applicable	none
Heartbeat	Normal Operation	not applicable	none
3	Recycle - Flame failed during run.	Initiate new trial for ignition. Flash code will remain through the ignition trial until flame is proved.	If system fails to light on next trial for ignition, check gas supply, pilot burner, flame sense wiring, contamination of flame rod, burner ground connection.
	Flame sensed out of sequence	If situation self corrects within 10 seconds, control returns to normal sequence. If flame out of sequence remains longer than 10 seconds, control goes to Flash code 6 + 4 (see below).	Check for pilot flame. Replace gas valve if pilot flame present. If no pilot flame, cycle "Call for Heat." If error repeats, replace control.
	Flame sense leakage to ground	Control remains in wait mode. When the fault corrects, control resumes normal operation after a one minute delay.	Check flame sense lead wire for damage or shorting. Check that flame rod is in proper position. Check flame rod ceramic for cracks, damage or tracking.
	Low secondary voltage supply - (below 15.5 Vac)	Control remains in wait mode. When the fault corrects, control resumes normal operation after a one minute delay.	Check transformer and AC line for proper input voltage to the control. Check with full system load on the transformer.
6+2	Failed trial for ignition resulting in lockout	Remain in lockout until "Call for Heat" is cycled.	Check gas supply, pilot burner, spark and flame sense wiring, flame rod contaminated or out of position, burner ground connection.
6+3	More than 5 flame failures during run on the same "Call for Heat" resulting in lockout	Remain in lockout until "Call for Heat" is cycled.	Check gas supply, pilot burner, flame sense wiring, contamination of flame rod, burner ground connection.
6+4	Flame sensed out of sequence - longer than 10 seconds.	Control waits until flame is no longer sensed and then goes to soft lockout. Flash code continues. Control auto resets from soft lockout after one hour.	Check for pilot flame. Replace gas valve if pilot flame present. If no pilot flame, cycle "Call for Heat." If error repeats, replace control.
ON	Soft lockout due to error detected during self check sequences	Control auto resets from soft lockout after one hour.	Reset by cycling "Call for Heat." If error repeats, replace the control.

**<sup>a</sup> Flash Code Descriptions:**

- Flash Fast: rapid blinking.
- Heartbeat: Constant ½ second bright ½ second dim cycles.
- A single flash code number signifies that the LED flashes X times at 2Hz, remains off for two seconds, and then repeats the sequence.
- X + Y flash codes signify that the LED flashes X times at 2Hz, remains off for two seconds, flashes Y times at 2Hz, remains off for three seconds, and then repeats the sequence.









**COMMERCIAL  
CIRCULATING WATER HEATER  
LIMITED WARRANTY**



**EFFECTIVE**

If within FIVE years after initial installation of the water heater, a heat exchanger or gas burner shall prove upon examination by the warrantor to be defective in material or workmanship, the warrantor, at his option will exchange or repair such part or portion.

For 1 Year, in the event of part failure, we will repair or, at our discretion, replace the defective part.

We warrant this product against defects in materials or workmanship as described in this document if installed within the United States or Canada and provided the product remains at its original place of installation.

Warranty coverage begins the date of installation OR the date of manufacture if installation cannot be verified.

**WHAT'S COVERED**

Subject to these terms, in the event of defect in materials and/or workmanship resulting in a **heat exchanger leak** during the **first five years**, we will:

- Replace or repair the heat exchanger.

Subject to these terms, in the event of a defect in materials and/or workmanship appearing during the **first year**, we will:

- Repair or, at our discretion, replace any part of the water heater covered under this limited warranty excluding parts subject to normal maintenance (Example: non-electronic anode rod, filter, etc)

**Service / labor, shipping, delivery, installation, handling or any other costs are not covered at any time under this warranty.**

Any replacement part or product will be warranted only for the unexpired portion of the original water heater's limited warranty period.

**WHAT'S NOT COVERED**

- Problems caused by improper: gas supply line sizing, gas type, venting, connections, combustion air, voltage, wiring, or fusing
- Failure to follow applicable codes
- Failure to follow printed instructions
- Abuse, misuse, accident, fire, flood, Acts of God
- Improper installation, sizing, delivery, or maintenance
- Claims related to rust, noise, smell, or taste of water
- Failure to conduct authorized factory start up if required
- Alterations to the water heater
- Non-outdoor heaters installed outdoors
- Damages due to a failure to allow for thermal expansion
- Heat exchanger failure due to lack of adequate / proper supply of water
- Heaters moved from their original location
- Service trips to explain proper installation, use, or maintenance of the product/unit or to describe compliance requirements under applicable codes and regulations
- Charges related to accessing your heater including but not limited to door/wall removal, equipment rental, etc.
- Replacement parts after expiration of this warranty

**LIMITATIONS**

NOTWITHSTANDING ANYTHING ELSE TO THE CONTRARY, THIS IS YOUR SOLE AND EXCLUSIVE WARRANTY. ALL OTHER WARRANTIES INCLUDING A WARRANTY OF MERCHANTABILITY OR FITNESS FOR PARTICULAR PURPOSE ARE EXPRESSLY DISCLAIMED. SELLER SHALL NOT BE LIABLE FOR ANY CONSEQUENTIAL, INCIDENTAL, SPECIAL, PUNITIVE OR OTHER INDIRECT DAMAGES. TOTAL LIABILITY ARISING AT ANY TIME SHALL NOT EXCEED THE PURCHASE PRICE PAID WHETHER BASED ON CONTRACT, TORT, STRICT LIABILITY OR ANY OTHER LEGAL THEORY.

**SERVICE INQUIRIES:**

For service inquiries call the telephone number listed below. Be prepared to provide the following information: name, address, and telephone number; the model and serial number of the water heater; proof of installation; and a clear description of the problem.

For your records, fill in the product:

Serial: \_\_\_\_\_

Model: \_\_\_\_\_

U.S. Customers:

**A. O. Smith Corporation**  
500 Tennessee Waltz Parkway  
Ashland City, Tennessee 37015  
800-527-1953  
[www.hotwater.com](http://www.hotwater.com)

Canadian Customers:

**P. O. Box 310 – 768 Erie Street**  
Stratford (Ontario) N5A 6T3  
800-265-8520



500 Tennessee Waltz Parkway, Ashland City, TN 37015  
Technical Support: 800-527-1953 • Parts: 800-433-2545  
[www.hotwater.com](http://www.hotwater.com)