



**McLennan** PRODUCTS, INC.  
CUSTOM LOCKERS



## OVER 30 YEARS AS AN INDUSTRY LEADER

### EXECUTIVE LOCKERS AND BENCHES

Ideal Products, Inc., has set the standard for quality, function and design of manufactured wood lockers. The pride of the industry, each locker is handcrafted by experts using modern designs evolved over thirty years of research and development. Ideal's techno-advanced factory is equipped with the latest in automatic, computer-controlled machinery to insure precise fabrication of all components and assembly with the utmost integrity.

Product innovation and creative design has established Ideal lockers as the true market leader. Today the Executive Style, or more commonly known "Z-locker" we introduced many years ago, is the single best-selling design available.

Our manufacturing facilities are located in the distribution center of Southern California, at the intersection of six major interstate freeways and minutes from the ports of Los Angeles and Long Beach, extending our capabilities to conveniently service our international customers.

### CUSTOM AND STANDARD DESIGN CAPABILITIES

Ideal's extensive manufacturing process, geared for expeditious mass-producing of lockers, is flexible for easy accommodation of custom and unique designs. Customers may select one of our many standard configurations or, with our assistance, design their own to meet special needs. Our designers will assist customers by analyzing specific criteria and create locker designs to meet individual requirements. Dimensions can be altered and/or add a hat, shoe, or golf ball shelves, vanity mirror, security vault, pull drawers, extra doors, coat rod, handles, coin trays, etc.

### IDEAL'S SERVICE DEMONSTRATES ATTENTION TO DETAIL

When analyzing our customer's locker requirements, Ideal will need to know the physical space available for lockers (both square and linear footage) to determine locker frame sizing; estimated maximum number of persons to use lockers during peak hours; and anticipated type of personal belongings to be

# LOCKER CONFIGURATIONS

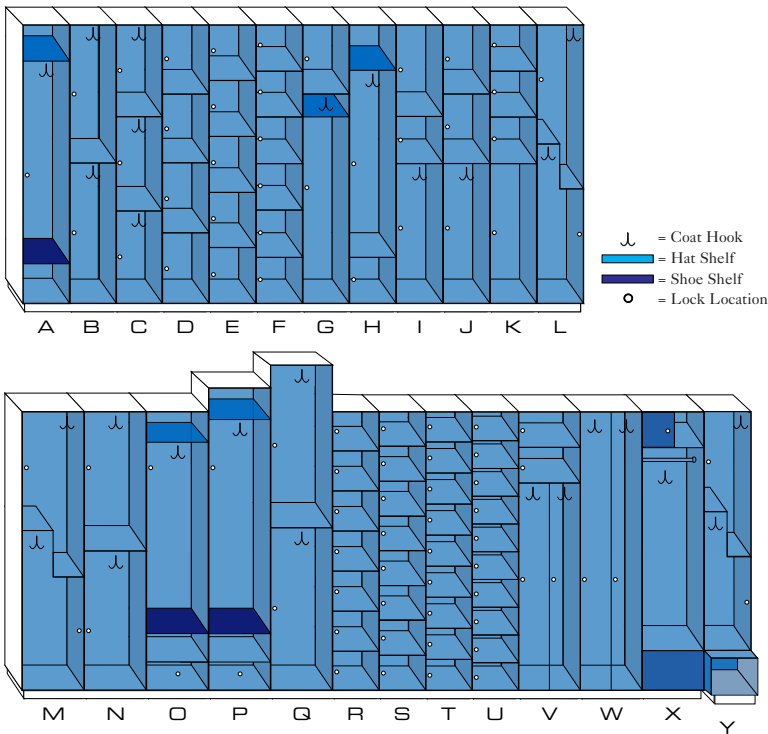

| ITEM | DESCRIPTION              | WIDTH | DEPTH | HEIGHT |
|------|--------------------------|-------|-------|--------|
| A    | One Tier                 | 12"   | 18"   | 72"    |
| B    | Standard Two Tier        | 12"   | 18"   | 72"    |
| C    | Three Tier - Gymbag      | 12"   | 18"   | 72"    |
| D    | Four Tier                | 12"   | 18"   | 72"    |
| E    | Five Tier                | 12"   | 18"   | 72"    |
| F    | Six Tier - Purse Size    | 12"   | 18"   | 72"    |
| G    | Modified Two Tier        | 12"   | 18"   | 72"    |
| H    | Modified Two Tier        | 12"   | 18"   | 72"    |
| I    | Modified Three Tier      | 12"   | 18"   | 72"    |
| J    | Modified Three Tier      | 12"   | 18"   | 72"    |
| K    | Modified Four Tier       | 12"   | 18"   | 72"    |
| L    | Executive Style Two Tier | 12"   | 18"   | 72"    |
| M    | Executive Style Two Tier | 16"   | 18"   | 72"    |
| N    | Standard Two Tier        | 16"   | 18"   | 72"    |
| O    | Tennis Club              | 16"   | 18"   | 72"    |
| P    | Country Club             | 16"   | 18"   | 78"    |
| Q    | Maxi-space               | 16"   | 18"   | 84"    |
| R    | Seven Tier               | 12"   | 18"   | 72"    |
| S    | Eight Tier               | 12"   | 18"   | 72"    |
| T    | Nine Tier                | 12"   | 18"   | 72"    |
| U    | Ten Tier - Sneaker       | 12"   | 18"   | 72"    |
| V    | Vertical Quad Tier       | 16"   | 18"   | 72"    |
| W    | Vertical Two Tier        | 16"   | 18"   | 72"    |
| X    | Epicenter                | 16"   | 18"   | 72"    |
| Y    | 3000 Series Model "L"    | 12"   | 18"   | 72"    |

## ORDERING INFORMATION

Examples: Ideal 1000 Series, Model B, 12" x 18" x 72", PL, RP, EH, VT  
 or: (1) (2) (3) (4) (5) (6) (7)

Examples: Ideal 2000 Series, Model F, 12" x 12" x 72", PL, DC, CH, SE

- Specify Ideal 1000 or 2000 Series for Fire-Retardant Plastic Laminate Wood Lockers. 1000 Series includes (VT) Vinyl T-molding and (EH) Exposed Knuckle Hinges. 2000 Series includes (SE) Self-Edging or (PVC) 1mm Poly Vinyl Chloride Edging and (CH) Concealed Hinges.
- Select the style and size locker compartment such as Model B, our standard double tier or Model F, our purse size lockers.

- Confirm the frame dimensions: Width x Depth x Height.
- Select plastic laminate as your exterior surface and choose any color or combination of colors.
- Specify Locks: (RP) Recessed Padlock Hasp; (PC) Pushbutton Combination; (DC) Dial Combination; (CL) Card Lock; (CO) Coin-Operated; (CC) Coin-Collect; (KL) Keyed; (TL) Token; (DKP) Digilock KP; (DKT) Digilock KT; or (DTL) Digilock TL.
- Specify Hinges: (CH) Concealed Hinge; or (EH) Exposed Knuckle.
- Specify Edging: (VT) Polyethylene Vinyl T-molding; (SE) Self-Edging; (PVC) 1mm Poly Vinyl Chloride; (WT) Wood Tape; or (WM) 1/4" Wood Molding.

stored in lockers—overcoats, suits, gym bags, wallets, purses—to assist our designers in determining required locker configurations.

Ideal's customers can consider their special requirements for locker accessories—lock requirements such as I.D. card operation or coin-collect rental lockers, security vaults, ski boot and pole storage, racket accommodation. When this information is compiled Ideal Products will determine your locker requirements, prepare shop drawings and present an itemized written quotation.

## USES, APPLICATIONS

Ideal Products' lockers, with their furniture-like quality and appearance, can be used where ever a need for personal security exists. Ideal lockers are found in Doctor's lounges, nurse's stations, colleges and universities, park and recreation facilities, health and fitness clubs, country clubs, sport stadiums, medical offices, and any number of work place related settings. See page 13 for a list of references.



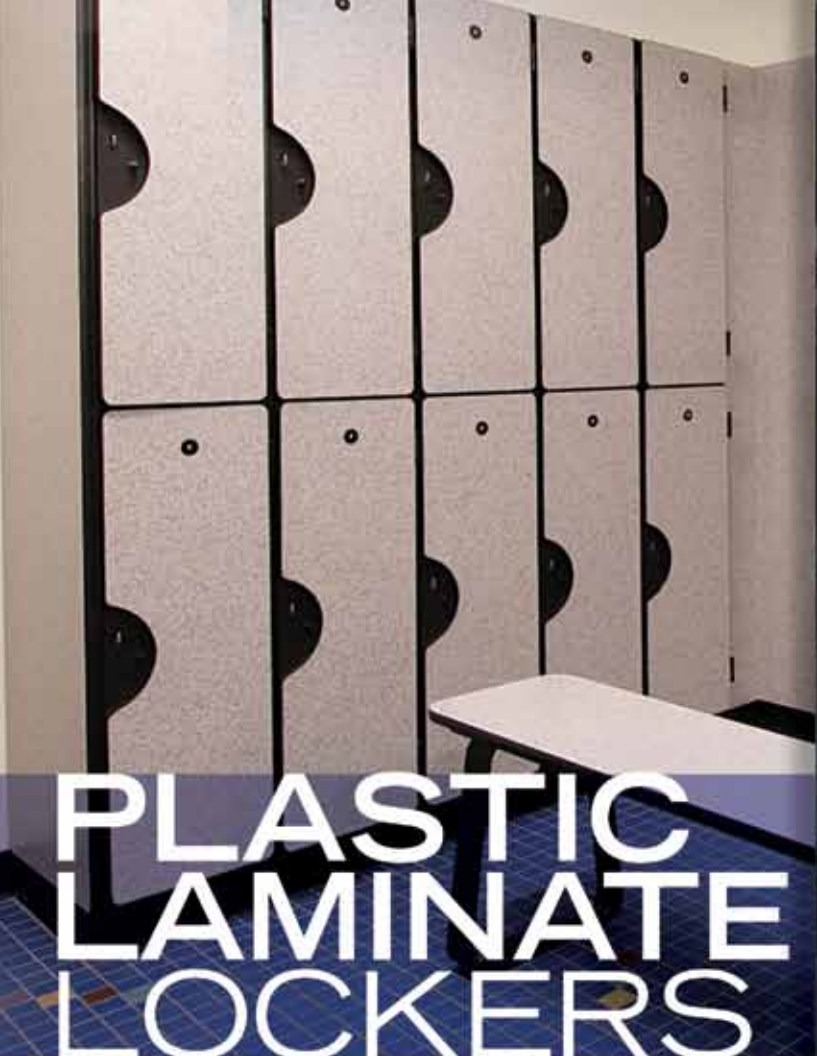

# PLASTIC LAMINATE LOCKERS



IMAGE 1000

## FURNITURE QUALITY & ECONOMY GRADE

- Custom and Standard Designs
- Thermal-Fused Melamine
- 40 Standard Colors
- One Year Warranty

## SPECIFICATIONS

**Material:** 48 lb. density, industrial grade particle board.

**Assembly:** Blunt joint and nail.

**Finish:** Thermal-fused low pressure melamine. Choose from 40 standard colors. Samples available upon request.

**Edging:** Vinyl T-Molding for doors and frame. Select from standard colors: black, white, grey, sand or brown.

**Hinges:** Heavy duty institutional, 2 3/4" five exposed knuckle (black).



## Ideal's Plastic Laminates for Durability and Variety

Ideal laminated doors, modern and economical, select one or several colors, textures, patterns, metallic or wood-grain plastic laminates as manufactured by Formica®, Wilsonart®, Nevamar®, Laminart®, Pionite® and Micarta®. Specify colors and alternate your selections by the frame for vertical stripes or by the door for a checkerboard-type appearance. Our laminated door construction has been tested and awarded UL Class B(II) fire rating.



Ideal 1000 Series — "L" lockers showing their versatility with white vinyl interiors.



IDEAL 3000

## FURNITURE QUALITY & FIRE RETARDANT

- Custom and Standard Designs
- Class II-B Fire Retardant
- Unlimited Color Selection
- Formica®, Wilsonart®, Nevamar®, Pionite®, Laminart®, Micarta® Finishes
- Three Year Warranty

## SPECIFICATIONS

**Material:** Fire-retardant, formaldehyde-free, 48 lb. industrial grade particle board.

**Assembly:** Blunt joint and nail.

**Finish:** Plastic laminate, class II-B, fire-retardant, water resistant, NEMA-LD-1 vertical grade .028" thick high pressure plastic laminate exposed.

**Edging:** Vinyl T-Molding for doors and frame. Select from standard colors: black, white, grey, sand or brown.

**Hinges:** Heavy duty institutional, 2 3/4" five exposed knuckle (black).

# IDEAL 1000

## FURNITURE QUALITY & FIRE RETARDANT

- Custom and Standard Designs
- Class II-B Fire Retardant
- Unlimited Color Selection
- Formica®, Wilsonart®, Nevamar®, Pionite®, Laminart®, Micarta® Finishes
- Three Year Warranty

### SPECIFICATIONS

**Material:** Fire-retardant, formaldehyde-free, 48 lb. industrial grade particle board.

**Assembly:** Blunt joint and nail.

**Finish:** Plastic laminate, class II-B, fire-retardant, water resistant, NEMA-LD-1 vertical grade .028" thick high pressure plastic laminate exposed.

**Edging:** Vinyl T-Molding for doors and frame. Select from standard colors: black, white, grey, sand or brown.

**Hinges:** Heavy duty institutional, 2 3/4" five exposed knuckle (black).



# IDEAL 2000

## FURNITURE QUALITY & FIRE RETARDANT

- Custom and Standard Designs
- Class II-B Fire Retardant
- Unlimited Color Selection
- Formica®, Wilsonart®, Nevamar®, Pionite®, Laminart®, Micarta® Finishes
- Three Year Warranty

### SPECIFICATIONS

**Material:** Fire-retardant, formaldehyde-free, 48 lb. industrial grade particle board.

**Assembly:** Blunt joint and nail.

**Finish:** Plastic laminate, class II-B, fire-retardant, water resistant, NEMA-LD-1 vertical grade .028" thick high pressure plastic laminate exposed.

**Edging:** Self-edging to match plastic laminate, 1mm, 2mm or 3mm PVC 1/8" 1/4" 5/8" lumber.

**Hinges:** Heavy duty, self-closing, 6-way adjustable, 125 degree opening euro-concealed (chrome).



IDEAL 3000-1

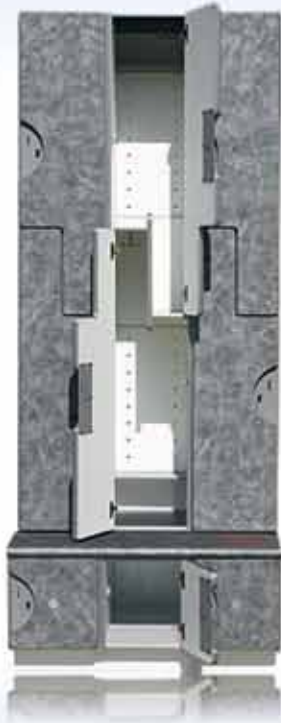

IDEAL 3000-2



IDEAL 3000-3

Our Ideal 3000 Series Plastic Laminate Lockers includes an integral seat and raised platform. Use any locker model that suits your needs and select from one of three options for the raised platform: lower cubby, lower locker and / or lower platform. For example specify; Ideal 3000-1 Series Model L, Executive Style Double Tier Lockers, 12x18x72" PL,VT,EH,RP. This specification includes all of the standard features of our lockers plus a postformed plastic laminate benchtop and lower cubby. The 3000-2 includes a lower locker and our 3000-3 includes a finished lower platform.

# MED-X 2000

## WATER RESISTANT & FIRE RETARDANT

- Custom and Standard Designs
- Class II-B Fire Retardant
- Unlimited Color Selection
- ASTM Six Cycle Tested Core Materials
- Three Year Warranty

### SPECIFICATIONS

**Material:** Woodstalk Gold MR Fiberboard. Exceeds ANSI A208, 1-1999 M3 low fuming resin according to ASTM E 1333-96, and less than .01 ppm formaldehyde emissions.

**Assembly:** Blunt joint and nail.

**Finish:** Plastic laminate, class II-B, fire-retardant, water resistant, NEMA-LD-1 vertical grade .028" thick high pressure plastic.



# EPICENTER 1000

## ATHLETIC LOCKERS

- Custom and Standard Designs
- Class II-B Fire Retardant
- Unlimited Color Selection
- Available in Formica®, Wilsonart®, Nevamar®, Laminart®, Pionite® and Micarta® Finishes
- Three Year Warranty

### SPECIFICATIONS

**Material:** Fire-retardant, formaldehyde-free, industrial grade particle board.

**Assembly:** Dowel and glue joining.

**Finish:** Plastic laminate, class II-B, fire-retardant, water resistant, NEMA-LD-1 vertical grade .028" thick high pressure plastic laminate exposed.



# DURA-FR 1000/2000

## FIRE RATED PLASTIC LAMINATE LOCKERS

- Custom and Standard Designs
- **Class I-A Fire-Retardant**
- Unlimited Color Selection
- Complies with HUD 24 CFR 3280 for Formaldehyde Emission Limit
- Fulfills the requirements of CPAQ1-02
- Three Year Warranty

### SPECIFICATIONS

**Material:** Duraflake FR particleboard UL approved Class I-A fire-retardant substrate for all components.

**Assembly:** Blunt joint and nail.

**Finish:** Plastic laminate, Class I-A fire-retardant and scratch resistant, NEMA-LD-1 vertical grade .032" thick high pressure plastic laminate on exposed surfaces.

#### Dura-FR 1000:

Vinyl T-molding  
Exposed Black 5 Knuckle Hinges

#### Dura-FR 2000:

Plastic Laminate Edging to Match  
Concealed Hinges



# SECURA 1000/2000

## COIN COLLECTION LOCKERS

- Custom and Standard Designs
- Class II-B Fire Retardant
- Unlimited Color Selection
- One to Six Coin Operation
- Common Collection Tube
- Three Year Warranty
- Security Vault

### SPECIFICATIONS

**Material:** Fire-Retardant, Formaldehyde-Free, 48-lb. Industrial Grade Particleboard

**Assembly:** Blunt Joint and Nail

**Finish:** Plastic laminate, class II-B, fire-retardant, water resistant, NEMA-LD-1 vertical grade .028" thick high-pressure plastic laminate exposed.

**Secura 1000:**  
Vinyl T-molding  
Exposed Hinges

**Secura 2000:**  
Edging to match  
Plastic Laminate  
Concealed Hinges

# WALLET LOCKERS

## FURNITURE QUALITY

Small, durable and attractive, our wallet lockers or valuables vaults are available in your choice of decorative, high-pressure plastic laminate with either keyed or dial combination locksets. Set them on your countertop or hang them on the wall. The wallet lockers are custom built to your specific requirements.



FIVE TIER WALLET LOCKER with keyed locks.

# CUBBIES 1000

## FURNITURE QUALITY

For short term storage of non-valuable personal belongings in areas such as aerobic rooms, reception areas or lobbies, weight rooms, etc. Our cubbies include water-resistant, fire-retardant high-pressure plastic laminate on all exposed surfaces and are available in standard frame sizes of 12" x 18" x 72" with either three, four, five or six storage spaces or custom sizes to satisfy your facilities requirements.



Eclipse Door



Rio Door



Deserée Door

Available variations of plastic laminate door styles for that more custom appearance.

## EXTERIOR FINISHES



[formica.com](http://formica.com)



[laminart.com](http://laminart.com)



[nevamar.com](http://nevamar.com)



[wilsonart.com](http://wilsonart.com)



[pionite.com](http://pionite.com)

Ideal offers a virtually limitless number of exterior laminates from these fine companies. Plastic laminates are available in solid colors, patterns, metallics, simulated woodgrains and more. Please visit these manufacturers' websites to see the vast selection available for your Ideal lockers.

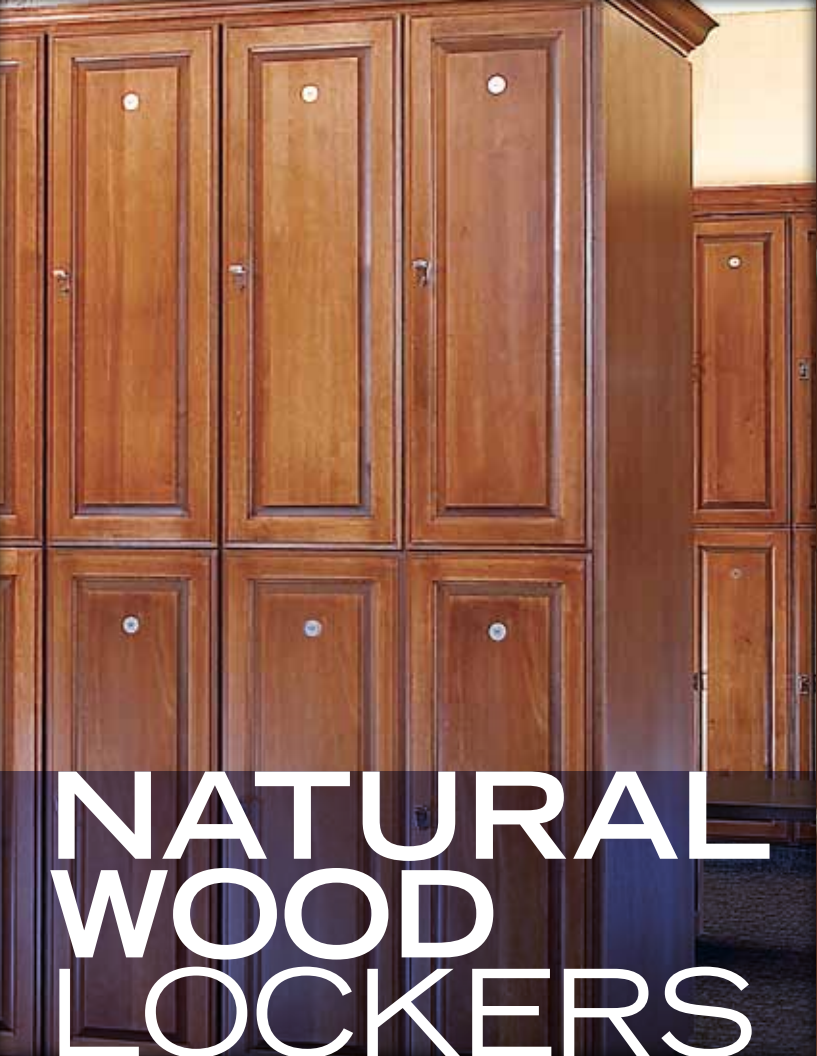

IMPERIAL 1000

# NATURAL WOOD LOCKERS

## FURNITURE QUALITY with VENEER DOORS

- Custom and Standard Designs
- Plain Sliced
- Quarter Sawn
- Rift Cut
- Book or Slip Matched
- Three Year Warranty

### SPECIFICATIONS

**Material:** 1/32" thickness select natural wood as specified. Grade AA on PB core.

**Assembly:** Blunt joint and nail.

**Finish:** Premium grade 3 coats clear satin, sanding between coats. Stains to match samples: custom or standard.

### FINISHES

Red or White Oak, Maple, Birch, Cedar, Elm, Knotty Pine, Teak, Mahogany, Walnut, Douglas Fir, Cherry, or Ash (limited to natures' resources).



### Ideal's Natural Wood Veneers or Solids for Elegance

We have the widest selection of natural woods possible: i.e., red or white oak; cedar; birch; cherry; Phillipine, Honduras, or African mahogany; teak; maple; walnut; knotty pine; douglas fir; and ash. Most will be available in various cuts such as plain sliced, rotary cut, quarter sawn, etc. Specify a stain or finish.

When specifying, use (WV) wood veneer, (RP) raised panel, (BB) butcher block, or (LO) louver and include the wood species.



#### STANDARD DIMENSIONS

Width: 12" or 16"  
 Depth: 18" or 20"  
 Height: 72", 78", or 84"

|                   |  |                     |
|-------------------|--|---------------------|
| Red Oak           | White Oak                                  | Cedar               |
| Birch             | Cherry                                     | Phillipine Mahogany |
| Honduras Mahogany | MOST POPULAR<br>NATURAL WOOD<br>SELECTIONS | African Mahogany    |
| Teak              | Maple                                      | Walnut              |
| Knotty Pine       | Douglas Fir                                | Ash                 |



# IMPERIAL 2000

## FURNITURE QUALITY with SOLID DOORS

- Custom and Standard Designs
- Raised Panel Design
- Genuine Louver
- Recess Panel
- Finger Joint
- Three Year Warranty

### SPECIFICATIONS

**Material:** 3/4" kiln dried solid select natural wood as specified.

**Assembly:** Blunt joint and nail.

**Finish:** Premium grade 3 coats clear satin, sanding between coats. Stains to match samples: custom or standard.

### FINISHES

Red or White Oak, Maple, Birch, Cedar, Elm, Knotty Pine, Teak, Mahogany, Walnut, Douglas Fir, Cherry, or Ash (limited to nature's resources).



# EPICENTER 2000

## FURNITURE QUALITY WOOD VENEER ATHLETIC LOCKERS

- Custom and Standard Designs
- Three Year Warranty

### SPECIFICATIONS

**Material:** 3/4" kiln dried solid select natural wood as specified.

**Assembly:** Blunt joint and nail.

**Finish:** Premium grade 3 coats clear satin, sanding between coats. Stains to match samples: custom or standard.

### FINISHES

Red or White Oak, Maple, Birch, Cedar, Elm, Knotty Pine, Teak, Mahogany, Walnut, Douglas Fir, Cherry, or Ash (limited to nature's resources).



## NEW WATER BASED WOOD STAINS:

### Stain Name

Clear

Light

Dark

### Wood Species

Cherry



Cherry



Red Oak



Maple



Maple



Alder



Louvered Panel Door



Liverpool Raised Panel Door



Cathedral Door



Full Length Finger Pul Door

# LOCKER ROOM AMENITIES

## BENCHES

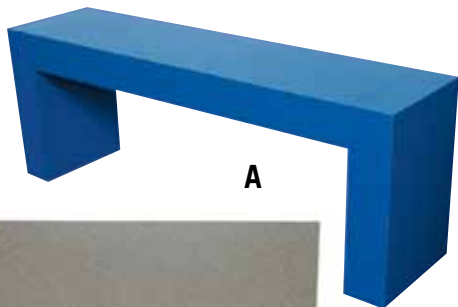
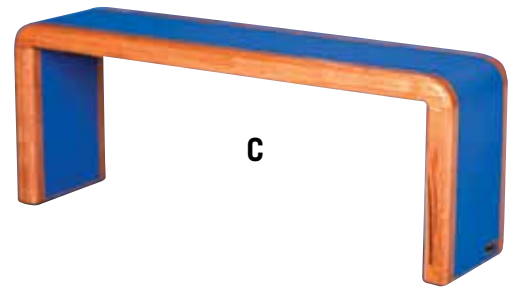

Quality crafted benches and stools are manufactured with the same care and attention as Ideal's lockers, each designed to complement the locker style of your choice. A variety of styles are standard in wood and laminate with carpet inserts as an added option on some styles. Available widths are 12" or 16" with lengths of 24", 36", 48", 60", 72", 84", or 96". Average heights of all of our benches is 17". Custom sizes or designs are also available.

**A ONTARIO BENCH** Sturdy and modern in appearance, all plastic laminate finished design to match lockers. Available in all standard sizes and ADA handicapped accessible.

**B VENTWOOD BENCH** Durable, yet aesthetically appealing; manufactured with clear vertical grain douglas fir slats, oak doweling, clear satin finish, and black powder coated legs. Legs are not sold separately.

**C WATERFALL BENCH** Edging is completed with 1" x 3" butcherboard in either red oak or maple. Inlay is fire retardant, water resistant, scratch resistant, and high pressure post forming plastic laminate. Standard clear satin finish and custom stains are available.

**D FAIRBANKS BENCH** Attractive and modern in appearance, our Fairbanks bench comes with legs of 4" wide red oak veneer edged with red oak butcherblock. Seat is completed with coordinated carpet. Finished with three coats of clear lacquer for added durability. Carpeting not included.

## STOOLS



Ideal offers the widest selection of matching stools available today. Like our benches, they are designed to complement your locker finish while enduring cruel and unusual punishment. Stools are available in 12" or 14" diameters and are 16" high in either plastic laminate or natural wood with black powder coated legs.

## LEGS



Black powder coated Tri-legs, T-legs, and Permanent Pedestal bases with lasting durability and beauty.

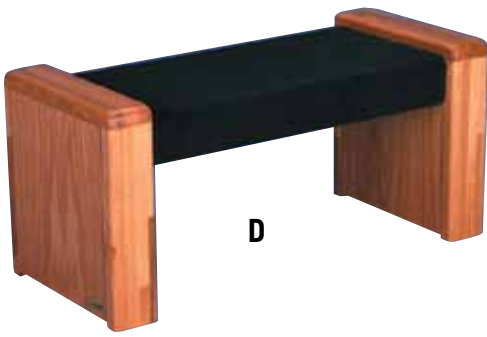

D



E

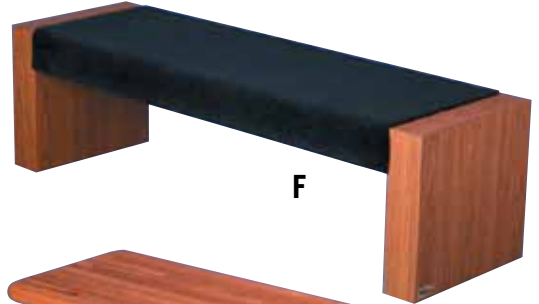

F



G

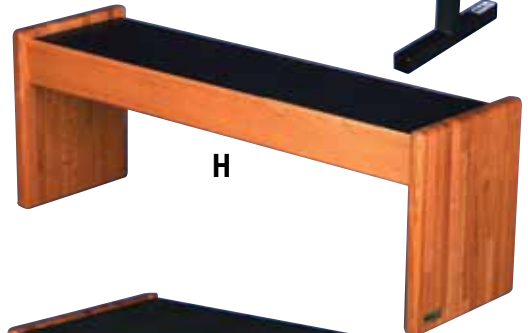

H



I

**E ECONO BENCH** Ideal's most popular bench style is available with plastic laminate tops and poly vinyl edging to match our lockers. Black powder-coated legs are either movable tri-legs or permanent pedestals.

**F COUNTRY CLUB BENCH** Mitered 4" plastic laminate legs with a carpet wrapped seat to match our laminate lockers. Construction of 1/2" solid maple with radius corners is used for interior structure. Standard clear satin finish. Legs are finished with matching plastic laminate. Carpeting not included.

**G BUTCHERBLOCK BENCH** Made of either red oak or maple butcherblock. 1 1/4" thickness available with stained and clear satin finish. The Butcherblock bench can be ordered with T-legs (shown) or 1 1/4" thick butcherblock legs.

**H BUTCHERBLOCK WITH INLAY BENCH** A beautiful bench to match plastic laminate lockers and add the luxury of natural wood. The laminate is inlayed with 3/4" natural red oak or maple butcherblock uprights. Standard clear satin finish and custom stains.

**I LOS ANGELES BENCH** Butcherblock legs with a carpet wrapped seat enhances that designer look. Legs are made of 1 1/4" thick solid butcherblock either in red oak or maple. Standard clear satin finish and custom stains are available. Carpeting not included.

## GROOMING STATIONS



J



K

**J ECONO GROOMING STATION** Designed to match lockers and finish off the ending of a double row of lockers. Includes a 24" mirror, strip lighting, 110V electrical outlet and a 12" shelf.

**K DELUXE GROOMING STATION** An excellent way to finish off a double row of lockers and add luxury to the room. Our Deluxe Grooming Station matches the lockers and includes a 24" mirror, strip lighting, 110V electrical outlet, two drawers, along with storage space.

## LOCKS



### Padlock Hasps

- A** Recessed
- B** Surface
- C** Campadlock

### Keyed Locks

- D** Standard
- E** High Security 6 Pin

### Dial Combination

- F** Master Lock 1670
- G** Master Lock 3670

### Programmable Mechanical

- H** Zephyr 3310
- I** Digilock ATS
- J** RL9041
- K** RL9046

### Electronic

- L** Ojmar OCS
- M** Zephyr 2310
- N** Codelock CL1000

### RFID

- O** Zephyr 2154
- P** Zephyr 2255
- Q** Ojmar Proximity

### Specialty

- R** Coin Operated
- S** Card Operated

## ACCESSORIES AND COMPONENTS

Designed and constructed for beauty and durability, Ideal has added optional items along with our standards to better satisfy our customer's needs. Add that extra shelf, swing-out mirror, or even a security vault — the amenities are numerous.



- A** Mirror
- B** Security Vault
- C** Double Prong, Ceiling Hung Coat Hook
- D** Double Prong Side Mounted Coat Hook
- E** Standard Nickel Plated Coat Rod
- F** 1 1/16" Dia. Chrome Coat Rod
- G** Name Plate
- H** Locking Roll-out Drawer
- I** Shoe Shelves
- J** Ventilation Grill

- K** Full Length Wood Pull
- L** Wire Pulls (3", 4", 5", Finish: Chrome or Brass)
- M** Black Knob
- N** Recessed Pulls
- O** Strike Plate
- P** Number Discs; 1 1/2" and 1 1/4" Black, Satin Chrome and Satin Brass
- Q** Heavy Duty Exposed Five Knuckle Hinge
- R** Nickel Plated Euroconcealed Hinge

# LOCKER ROOM DIAGRAMS

## GENERAL NOTES

- Locker to be standard as manufactured by Ideal Lockers.
- $\frac{5}{8}$ " spacers edged with matching edging to allow for hand clearance.
- Single end panels  $18\frac{5}{8}$ " wide to cover rear ventilation.
- Double end panels  $36\frac{5}{8}$ " wide to allow for air space.
- Fillers are required.
- TLW (total locker width) = Total number of lockers x locker width.  
12" lockers are 12.0625" wide; 16" lockers are 16.0625" wide.
- Consult factory for requirements.

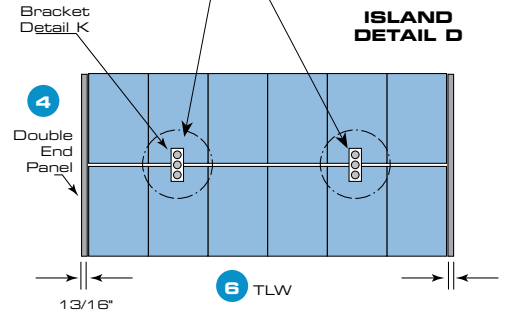
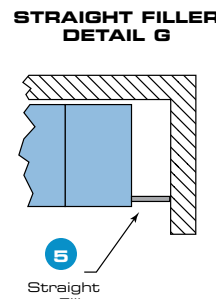
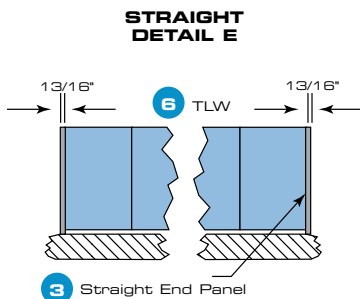
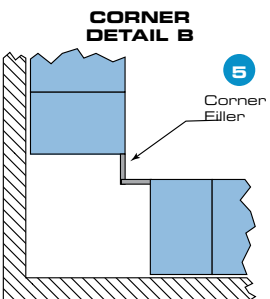
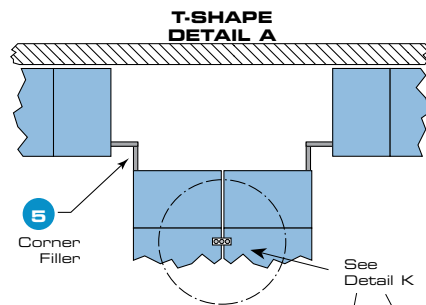
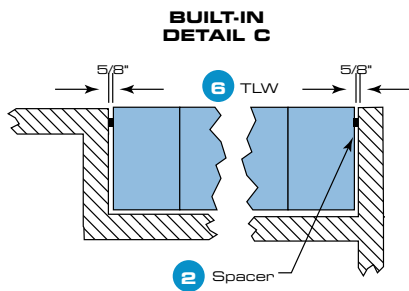
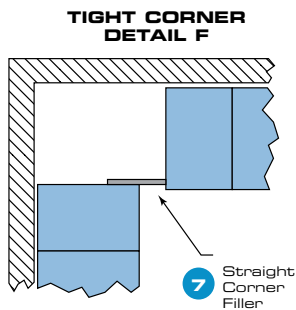
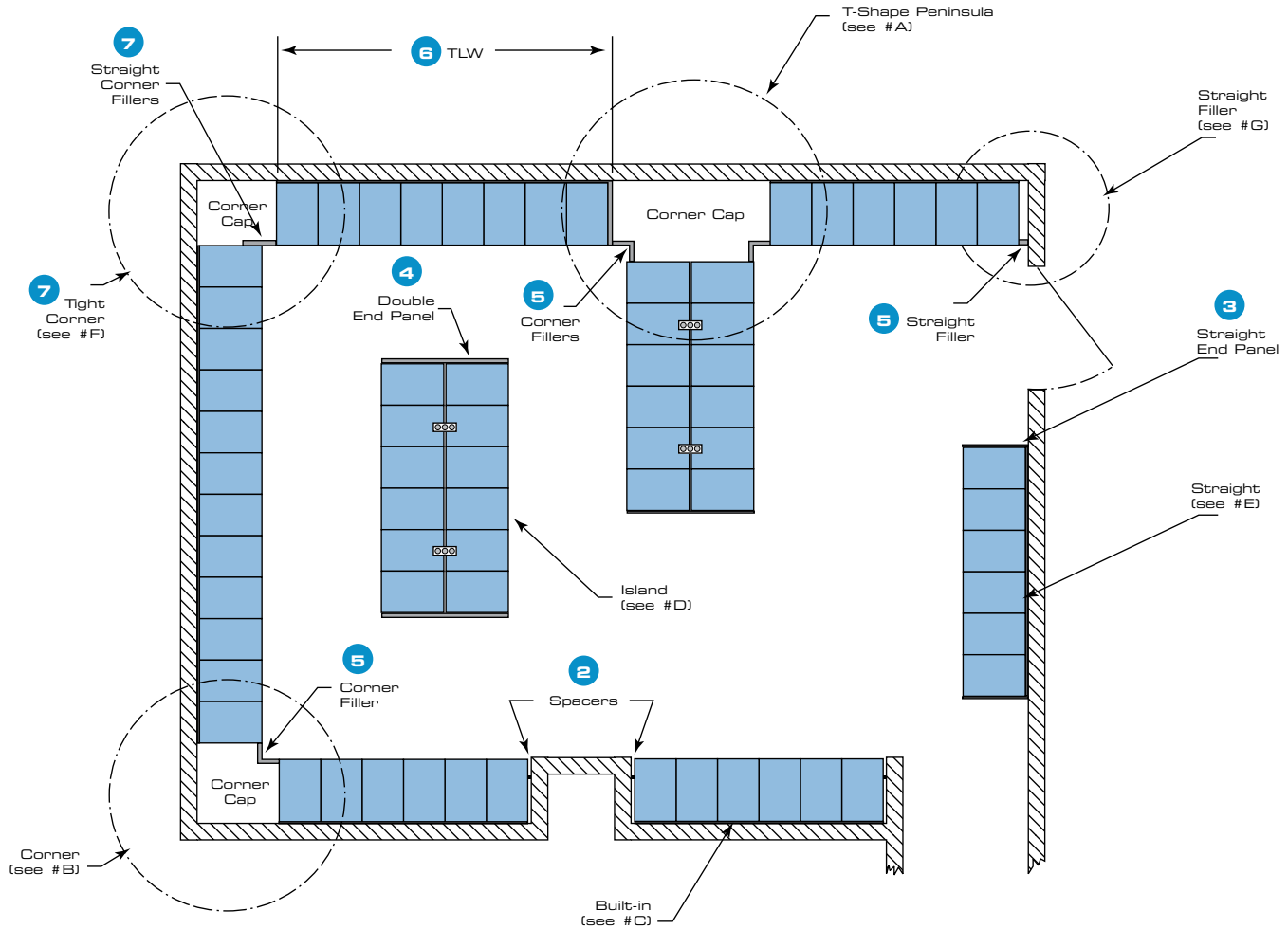

# HANDICAPPED OPTIONS

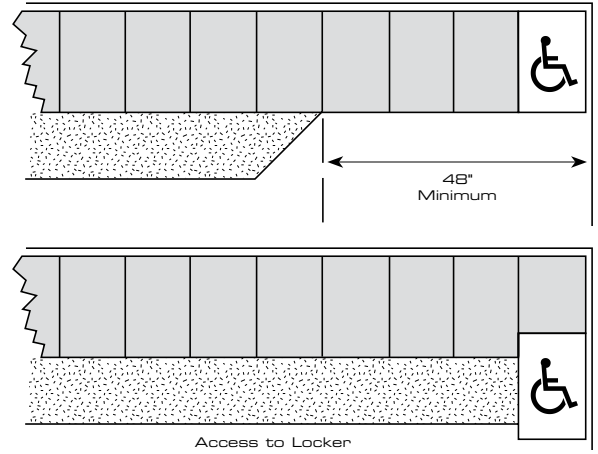
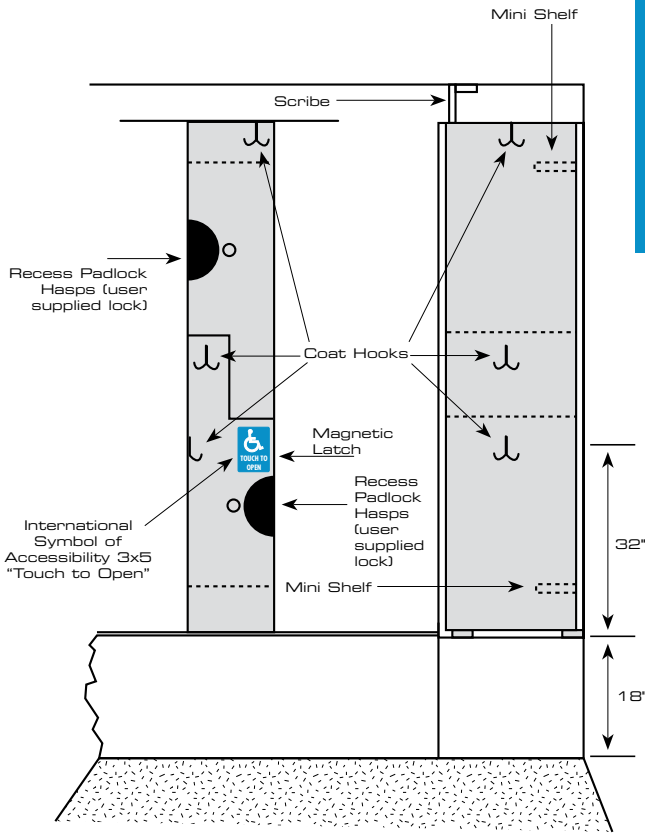

Local building officials will eventually require your clubs to comply with The Americans with Disabilities Act of 1990 which requires the following: At least one of each type locker offered, and for double-tier lockers only the bottom row, be provided for handicapped people. A clear floor space of 30"x48" minimum will allow for either forward or parallel approach by a person using a wheelchair. Storage spaces such as shelves, hooks, coat rods, etc., shall be located at a height of 9" minimum and 48" maximum from the finished floor. Acceptable hardware for accessible lockers are touch latches and U-shaped pulls located as close to the top of the door as possible.

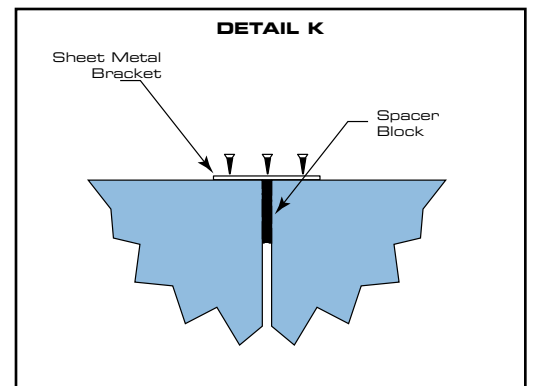
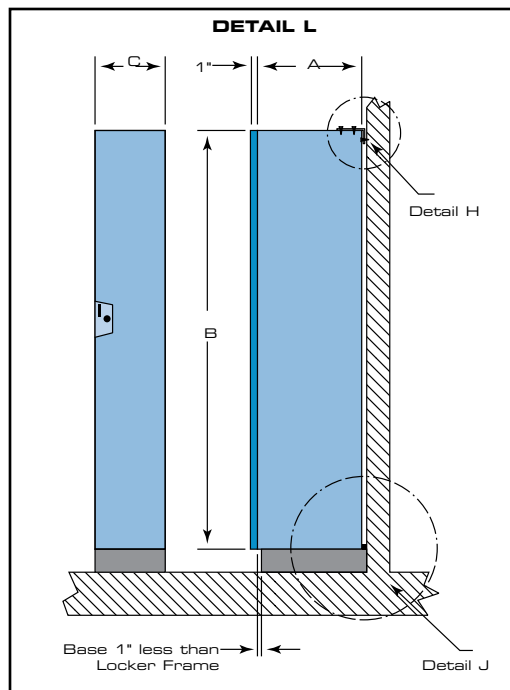
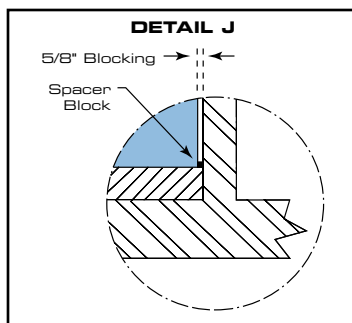
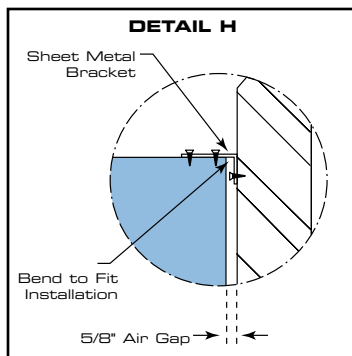

# REFERENCES

- Captain Cook Hotel, Fairbanks, AK  
Alaska Club, Juneau, AK  
Palos Verde Golf Club, Palos Verde Estates, CA  
Claremont Country Club, Oakland, CA  
Auburn Country Club, Loomis, CA  
Claremont Club, Claremont, CA  
Westin Riverfront, Avon, CO  
Blue Lakes Country Club, Twin Falls, ID  
Lexington Athletic Club, Lexington, KY  
Louisville Athletic Club, Louisville, KY  
New Bedford Country Club, North Dartmouth, MA  
Latitude Sports Club, Peabody, MA  
Gold's Gym, Millis, MA  
Columbia Country Club, Chevy Chase, MD  
Beaver Creek Golf Club, Hagerstown, MD  
Stadium Club, Reno, NV  
Mid-Hudson Athletic Club, Kingston, MD  
West Hills Racquet Club, Tigard, OR  
Lakeview Country Club, Northeast, PA  
Silver Mountain Sports Club, Park City, UT  
Country Club of Fairfax, Fairfax, VA  
Mercer Island Country Club, Mercer Island, WA  
Chamizal Tennis Club, Salinas, CA  
The Ridge Club, Cincinnati, OH  
Maryland Athletic Club, Timonium, MD  
Cardio Club, Orlando, FL  
Hardscrabble Club, Brewster, NY  
LA Fitness, Avondale, AZ  
Fitness Works, Chandler, AZ  
Ultimate Fitness, American Canyon, CA  
Disney Fitness, Anaheim, CA  
Touchstone Climbing, San Francisco, CA  
No Limits, Vista, CA  
USN Submarine Base, Point Loma, CA  
Body Xchange Sports Club, Bakersfield, CA  
VRC Fitness, Abbotsford, BC, CAN  
Canyon Meadows, Calgary, AL, CAN  
Spa Lady, Calgary, AL, CAN  
World Health, Calgary, AL, CAN  
Tori Plaza Gym, Medicine Hat, AL, Can  
Forsa Fitness Center, Denver, CO  
One Boulder Fitness, Boulder, CO  
Big Sky Fitness, New Britton, CT  
Fitness Edge, Shelton, CT  
Results Gym, Washington, DC  
Nemours's Fitness, Wilmington, DE  
Compass Health & Fitness, Ocala, FL  
Workout Anytime, Marietta, GA  
Resolution Fitness, Atlanta, GA  
Aspen Athletic Club, Des Moines, IA  
New Life Fitness, Cedar Park, IA  
Provena Fitness Aurora, IL  
Gold's Gym, Gurnee, IL  
Inwood Athletic Club, Joliet, IL  
Louisville Athletic Club, Clarksville, IN  
Sasebo Fitness Center, Sasebo, Japan  
Baly's Total Fitness, Baton Rouge, LA  
Slidell Athletic Club, Slidell, LA  
Power Fitness LLC, Boston, MA  
Body Shapers, Burlington, MA  
Swansea Total Fitness, Swansea, MA  
Gold's Gym, Medford, MA  
Maryland Athletic Club, Baltimore, MD  
Barton Marlow Fitness, Detroit, MI  
E-Fitness & Wellness, Biloxi, MS  
Rush Fitness, Burlington, NC  
Millennium Sports Club, Durham, NC  
Glaxo-Smith-Kline Fitness Center, Research Triangle Park, NC  
Gold's Gym, Concord, NH  
Morris Crossroads Fitness, Budd Lake, NJ  
Strength & Fitness Club, Cranford, NJ  
Defined Fitness, Albuquerque, NM  
Premier Fitness & Health Spa, Alamogordo, NM  
St. Mary's Wellness Center, Reno, NV  
Big Al's Fitness Center, Astoria, NY  
Gold's Gym, Clifton Park, NY  
Planet Fitness, Dewitt, NY  
Fitness Forum, Fayetteville, NY  
MAC Fitness, Kingston, NY  
Club H Fitness, New York, NY  
The Life Gym, New York, NY  
Planet Fitness, Schenectady, NY  
Sport Time Fitness, Schenectady, NY  
Synergy Fitness, Staten Island, NY  
Gold's Gym, Williamsville, NY  
World Gym, East Schenectady, NY  
Fit Happens, Amsterdam, NY  
Tec town Fitness, Waterloo, ONT, CAN  
The Dales Fitness & Court Club, The Dales, OR  
Lifestyle Family Fitness, Windsor, ALB, CAN  
LA Fitness, Hillsboro, OR  
Sweat Fitness, King of Prussia, PA  
Y Sweat, Inc. Philadelphia, PA  
Well fit Express, Brodheadsville, PA  
Workout Fitness, Lancaster, PA  
New Life Fitness World, Lexington, SC  
World Gym, Chattanooga, TN  
The Rush Fitness Center, Knoxville, TN  
Murfreesboro Athletic Club, Murfreesboro, TN  
Fit Athletic Club, Houston, TX  
Panhandle Fitness, Midland, TX  
Gold's Gym, San Angelo, TX  
Bodyworks, LLC; Lubbock, TX  
Gold's Gym, Layton, UT  
Gold's Gym, Taylorsville, UT  
Van Winkle Fitness, Salt Lake City, UT  
American Family Fitness, Richmond, VA  
LA Fitness, Covington, WA  
LA Fitness, Federal Way, WA  
Sammamish Club, Issaquah, WA  
Washington Athletic Club, Seattle, WA  
All Star Fitness, Seattle, WA  
LA Fitness, Mill Creek, WA  
Get Fit Health Club, Beaver Dam, WI  
Capitol Fitness, Madison, WI  
Prairie Athletic Club, Sun Prairie, WI  
Preferred Fitness, Inc. Muskego, WI  
Global Fitness Center, Leominster, MA  
Gold's Gym, Conroe, TX  
Eclipse Fitness, Dunellen, NJ  
Ashburn Village Sports Pavilion, Ashburn, VA  
Hyatt Regency Spa, Las Vegas, NV  
American Family Fitness, Middlethian, VA  
Merritt Athletic Club, Baltimore, MD  
Carmel Ranch Tennis club, Carmel, CA  
Goal's Soccer Center, Southgate, CA  
Student Fitness & Recreation, Normal, IL  
LA Fitness, Riverside, CA  
Martini Fitness, Stoughton, MA  
CIA Fitness Center, McLean, VA  
Planet Fitness, Dewitt, NY  
American Family Fitness, Colonial Heights, VA  
LA Fitness, Miami, FL  
World's Gym, Wayne, NJ  
Fusion Fitness, Santa Rosa, CA  
Cox Fitness & Rehab, Springfield, MO  
Mike's Gym, Dracut, MA  
Metalmark Gym, Fresno, CA  
BOE Racquetball Center, Woodside, NY  
West End Racquet Club, Torrance, CA  
Downtown YMCA, Phoenix, AZ  
Milton-Orange YMCA, Milford, CT  
Schroeder YMCA, Brown Deer, WI  
Scheu Family YMCA, Upland, CA  
Parkville Family YMCA, Parkville, MA  
Valley of the Sun YMCA, Phoenix, AZ  
McGrath YMCA, Spring Valley, CA  
South Pasadena YMCA, South Pasadena, CA  
YMCA, Spartanburg, SC  
Family YMCA, Bartlesville, OK  
Pepperdine University, Malibu, CA  
Southwestern College, San Diego, CA  
California Academy of Science, San Gabriel, CA  
California Lutheran University, Thousand Oaks, CA  
St. Augustine University, San Marcos, CA  
Elmcrest College of Applied Arts, Toronto, ONT, CAN  
University of Colorado, Aurora, CO  
University of Colorado, Boulder, CO  
University of Connecticut, West Haven, CT  
University of Iowa, Iowa City, IA  
University of Illinois, Champaign, IL  
Zachary High School, Zachary, LA  
Boston University, Boston, MA  
Tuft's University, Boston, MA  
Bloomberg School of Public Health, Baltimore, MD  
Bryan Mawr School, Baltimore, MD  
University of Maryland, Catonsville, MD  
Davenport University, Caledonia, MI  
Duke University Medical Center, Durham, NC  
College of New Rochelle, New Rochelle, NY  
Oak Hills High School, Cincinnati, OH  
Waterloo University, Waterloo, ONT, CAN  
Milton Hershey School, Hershey, PA  
Harpeth Hall Upper School, Nashville, TN  
Toole Elementary School, Farmersville, TX  
The Fay School, Houston, TX  
University of Wisconsin, Madison, WI  
Johnson & Wales University, Providence, RI  
Western University, Pomona, CA  
Iowa State University, Ames, IO  
Princess Nora University, Jeddah, Saudi Arabia  
Doha International Airport, Dohar, Qatar  
Abbot Vascular, Temecula, CA  
Western University Veterinary Clinic, Pomona, CA  
Amylin Pharmaceuticals, San Diego, CA  
Dupage Medical Center, Glenn Ellyn, IL  
Boston Healthcare for the Homeless, Boston, MA  
Brunswick Forest Wellness Center, Leland, NC  
Wyeth Administration Building, Sanford, NC  
Spectrum Orthopedics, Canton, OH  
St. Elizabeth Healthcare, Youngstown, OH  
St. John's Medical Center, Tulsa, OK  
Prairie Life Center, Franklin, TN  
Dixie Regional Medical Center, St. George, UT  
Swedish Orthopedics, Seattle, WA  
Hannah Center, Marshfield, WI  
Charlton Methodist Bed tower, Dallas, TX  
Genentech Research, Dixon, CA  
Jefferson Regional Medical Center, Little Rock, AR  
Sharp Grossmont Hospital, La Mesa, CA  
Lazarus Oral Health Center, Aurora, CO  
USC Acute Care Tower, Los Angeles, CA  
St. Joseph's Health Center, Warren, OH  
Roseville Health & Wellness, Folsom, CA  
Children's Ambulatory Care, Seattle, WA  
Lexington Medical Center, Lexington, KY  
Osceola Regional Medical Center, Kissimmee, FL  
L5 Heart Center, Oakland, CA  
St. Mary's Wellness Center, Reno, NV  
Mercy San Juan Medical Center, Carmichael, CA  
Martin's Point Healthcare, Kennebunk, ME  
Riddle Surgery Center, Media, PA  
Immanuel Medical Center, Omaha, NE  
Spectrum Medical Health Group, Sparta, MI  
Hackensack Medical Center, Hackensack, NJ  
Augusta Medical Center, Fishersville, VA  
Cancer Treatment Center, Goodyear, AZ  
Emory Hospital, Atlanta, GA  
St. Elizabeth's Medical Center, Brighton, MA  
Hackle Hospital, Grand Rapids, MI  
Maple Grove Hospital, Crosby, MN  
Chippewa County Hospital, Montevideo, MN  
St. Luke's Outpatient, Chesterfield, MO  
SEMO Hospital, Florissant, MO  
Spartanburg Regional Healthcare, Spartanburg, NC  
North Carolina Special Care Center, Wilson, NC  
Catholic Medical Center, Manchester, NH  
Essex Country Hospital, Cedar Grove, NJ  
St. Peter's University Hospital, New Brunswick, NJ  
Albuquerque Regional Medical Center, Albuquerque, NM  
West Chester Medical Center, West Chester, OH  
Salem Hospital, Salem, OR  
CCMH Patient Care, Parkersburg, WV  
Sherman Hospital, Elgin, IL  
Lakeside Hospital, Omaha, NE  
Northwest Community Hospital, Arlington Heights, IL  
IH Des Moines West Hospital, West Des Moines, IA  
Children's Hospital of Los Angeles, CA  
Children's Hospital of Orange County, Irvine, CA  
Children's Hospital of Phoenix, AZ  
Moore Regional Hospital, Southern Pines, NC  
Bay Health Medical Center, Dover, DE  
South Austin Hospital, Austin, TX  
York Hospital, York, ME  
Seattle Children's Hospital, Bellevue, WA  
Children's Hospital of Omaha, NE  
Lompoc Hospital, Lompoc, CA  
Sherman Hospital, Elgin, IL  
North Florida Hospital, Gainesville, FL  
Lancaster General Hospital, Lancaster, PA  
Fresno Heart Hospital, Fresno, CA  
St. Francis Hospital, Cape Girardeau, MO  
Swedish Issaquah Hospital, Issaquah, WA  
McConnell AFB



Phone 951/727-8600

Fax 951/727-8612

800-88-IDEAL

**idealockers.com**

P.O. Box 4090 | Ontario, CA 91761

