



Operator Manual

Generator Set with QSJ5.9G Engine and PowerCommand® 1.1 Control

C45 N6 (Spec A)
C50 N6 (Spec A)
C60 N6 (Spec A)
C70 N6 (Spec A)
C80 N6 (Spec A)
C100 N6 (Spec A)

**CALIFORNIA
Proposition 65**

Warning: Natural Gas/Liquid Propane Gas engine exhaust and some of its constituents are known to the State of California to cause cancer, birth defects, and other reproductive harm.

Table of Contents

1. IMPORTANT SAFETY INSTRUCTIONS	1
1.1 Warning, Caution, and Note Styles Used in This Manual	1
1.2 General Information	1
1.3 Generator Set Safety Code	4
1.4 Moving Parts Can Cause Severe Personal Injury or Death	4
1.5 Electrical Shocks and Arc Flashes Can Cause Severe Personal Injury or Death.....	5
1.6 Fuel and Fumes Are Flammable	5
1.7 Batteries Can Explode	6
1.8 Exhaust Gases Are Deadly.....	7
1.9 The Hazards of Carbon Monoxide.....	9
1.10 Earth Ground Connection	9
2. INTRODUCTION.....	11
2.1 Safety.....	11
2.2 About This Manual.....	11
2.3 Schedule of Abbreviations	12
2.4 Related Literature	14
2.5 Model Specifications	15
2.6 After Sales Services.....	19
2.7 General Operating Conditions	20
2.8 Generator Set Nameplate	21
2.9 Manufacturing Facilities	23
3. CONTROL SYSTEM.....	25
3.1 Control System Description	25
3.2 Display Text or Symbolic Version	29
3.3 Exercise Settings	30
3.4 Brightness and Contrast	38
3.5 History and About Menu	40
3.6 Fault Log.....	42
3.7 Selecting Operating Modes.....	44
3.8 Operating Modes	49
4. OPERATION - POWERCOMMAND 1.1	51
4.1 Introduction	51
4.2 General Operating Conditions	51
4.3 Generator Set Operation.....	51
5. MAINTENANCE	63
5.1 Maintenance Safety	63
5.2 Periodic Maintenance	66
5.3 Exercising the Generator Set	71
5.4 Engine Oil	71

5.5 Air Intake System.....	77
5.6 Batteries.....	79
5.7 Spark Plugs	83
6. TROUBLESHOOTING	85
6.1 Avoiding Generator Set Shutdowns	85
6.2 Fault Code Introduction.....	85
6.3 Engine Is Difficult to Start or Does Not Start	85
6.4 Code 143 - Engine Oil Pressure Low (Warning)	86
6.5 Codes 146 and 151 - Engine Coolant Temperature High (Warning or Shutdown)	86
6.6 Code 155 - Intake Manifold Temperature High (Shutdown).....	87
6.7 Code 197 - Coolant Level Low (Warning)	87
6.8 Code 415 - Engine Oil Pressure Low (Shutdown).....	88
6.9 Code 441 - Battery Voltage Low (Warning).....	88
6.10 Code 488 - Intake Manifold Temperature High (Warning).....	89
6.11 Code 1438 - Fail to Crank (Shutdown).....	90
6.12 Code 1472 - High AC Current (Shutdown).....	90
6.13 Code 5134 - Unknown Shutdown at Idle	90

1 IMPORTANT SAFETY INSTRUCTIONS

SAVE THESE INSTRUCTIONS. This manual contains important instructions that should be followed during installation and maintenance of the generator set and batteries.

Safe and efficient operation can be achieved only if the equipment is properly operated and maintained. Many accidents are caused by failure to follow fundamental rules and precautions.

1.1 Warning, Caution, and Note Styles Used in This Manual

The following safety styles and symbols found throughout this manual indicate potentially hazardous conditions to the operator, service personnel, or equipment.

DANGER

Indicates a hazardous situation that, if not avoided, will result in death or serious injury.

WARNING

Indicates a hazardous situation that, if not avoided, could result in death or serious injury.

CAUTION

Indicates a hazardous situation that, if not avoided, could result in minor or moderate injury.

NOTICE

Indicates information considered important, but not hazard-related (e.g., messages relating to property damage).

1.2 General Information

This manual should form part of the documentation package supplied by Cummins Inc. with specific generator sets. If this manual has been supplied in isolation, please contact your authorized dealer.

NOTICE

It is in the operator's interest to read and understand all warnings and cautions contained in the documentation relevant to the generator set operation and daily maintenance.

General Safety Precautions

WARNING

Hot Pressurized Liquid

Contact with hot liquid can cause severe burns.

Do not open the pressure cap while the engine is running. Let the engine cool down before removing the cap. Turn the cap slowly and do not open it fully until the pressure has been relieved.

WARNING

Moving Parts

Moving parts can cause severe personal injury.

Use extreme caution around moving parts. All guards must be properly fastened to prevent unintended contact.

WARNING

Toxic Hazard

Used engine oils have been identified by some state and federal agencies to cause cancer or reproductive toxicity.

Do not ingest, breathe the fumes, or contact used oil when checking or changing engine oil. Wear protective gloves and face guard.

WARNING

Electrical Generating Equipment

Incorrect operation and maintenance can result in severe personal injury or death.

Do not operate equipment when fatigued, or after consuming any alcohol or drug.

Make sure that only suitably trained and experienced service personnel perform electrical and/or mechanical service.

WARNING

Toxic Gases

Substances in exhaust gases have been identified by some state and federal agencies to cause cancer or reproductive toxicity.

Do not breathe in or come into contact with exhaust gases.

WARNING

High Noise Level

Generator sets in operation emit noise, which can cause hearing damage.

Wear appropriate ear protection at all times.

⚠ WARNING**Hot Surfaces**

Contact with hot surfaces can cause severe burns.

The unit is to be installed so that the risk of hot surface contact by people is minimized. Wear appropriate PPE when working on hot equipment and avoid contact with hot surfaces.

⚠ WARNING**Toxic Hazard**

Ethylene glycol, used as an engine coolant, is toxic to humans and animals.

Wear appropriate PPE. Clean up coolant spills and dispose of used coolant in accordance with local environmental regulations.

⚠ WARNING**Combustible Liquid**

Ignition of combustible liquids is a fire or explosion hazard which can cause severe burns or death.

Do not store fuel, cleaners, oil, etc., near the generator set. Do not use combustible liquids like ether.

⚠ WARNING**Combustible Gases**

Generator sets in operation have combustible gases under pressure, which if ignited can cause eye and ear damage.

Wear appropriate eye and ear protection at all times.

⚠ WARNING**Combustible Gases**

Generator sets in operation have combustible gases under pressure, which if ignited can cause severe injury.

Do not operate the generator set with any doors open.

⚠ WARNING**Fire Hazard**

Materials drawn into the generator set, as well as accumulated grease and oil, are a fire hazard. Fire can cause severe burns or death.

Keep the generator set and the surrounding area clean and free from obstructions. Make sure the generator set is mounted in a manner to prevent combustible materials from accumulating under the unit.

⚠ WARNING***Automated Machinery***

Accidental or remote starting of the generator set can cause severe personal injury or death.

Isolate all auxiliary supplies and use an insulated wrench to disconnect the starting battery cables (negative [-] first).

NOTICE

Keep multi-type ABC fire extinguishers close by. Class A fires involve ordinary combustible materials such as wood and cloth. Class B fires involve combustible and flammable liquid fuels and gaseous fuels. Class C fires involve live electrical equipment. (Refer to NFPA No. 10 in the applicable region.)

NOTICE

Before performing maintenance and service procedures on enclosed generator sets, make sure the service access doors are secured open.

NOTICE

Stepping on the generator set can cause parts to bend or break, leading to electrical shorts, or to fuel, coolant, or exhaust leaks. Do not step on the generator set when entering or leaving the generator set room.

1.3 Generator Set Safety Code

Before operating the generator set, read the manuals and become familiar with them and the equipment. **Safe and efficient operation can be achieved only if the equipment is properly operated and maintained.** Many accidents are caused by failure to follow fundamental rules and precautions.

⚠ WARNING***Electrical Generating Equipment***

Incorrect operation and maintenance can result in severe personal injury or death.

Read and follow all Safety Precautions, Warnings, and Cautions throughout this manual and the documentation supplied with the generator set.

1.4 Moving Parts Can Cause Severe Personal Injury or Death

- Keep hands, clothing, and jewelry away from moving parts.

- Before starting work on the generator set, disconnect the battery charger from its AC source, then disconnect the starting batteries using an insulated wrench, negative (–) cable first. This will prevent accidental starting.
- Make sure that fasteners on the generator set are secure. Tighten supports and clamps; keep guards in position over fans, drive belts, etc.
- Do not wear loose clothing or jewelry in the vicinity of moving parts or while working on electrical equipment. Loose clothing and jewelry can become caught in moving parts.
- If any adjustments must be made while the unit is running, use extreme caution around hot manifolds, moving parts, etc.

1.5 Electrical Shocks and Arc Flashes Can Cause Severe Personal Injury or Death

- Only qualified service personnel certified and authorized to work on power circuits should work on exposed energized power circuits.
- All relevant service material must be available for any electrical work performed by certified service personnel.
- Exposure to energized power circuits with potentials of 50 VAC or 75 VDC or higher poses a significant risk of electrical shock and electrical arc flash.
- Refer to standard NFPA 70E, or equivalent safety standards in corresponding regions, for details of the dangers involved and for safety requirements.

1.6 Fuel and Fumes Are Flammable

Fire, explosion, and personal injury or death can result from improper practices.

- Do not fill fuel tanks while the engine is running unless the tanks are outside the engine compartment. Fuel contact with hot engine or exhaust is a potential fire hazard.
- Do not permit any flame, cigarette, pilot light, spark, arcing equipment, or other ignition source near the generator set or fuel tank.
- Fuel lines must be adequately secured and free of leaks. Fuel connection at the engine should be made with an approved flexible line. Do not use copper piping on flexible lines as copper will become brittle if continuously vibrated or repeatedly bent.
- Make sure all fuel supplies have a positive shutoff valve.
- Make sure the battery area has been well-ventilated prior to servicing near it. Lead-acid batteries emit a highly explosive hydrogen gas that can be ignited by arcing, sparking, smoking, etc.

Do Not Operate in Flammable and Explosive Environments

Flammable vapor can cause an engine to over speed and become difficult to stop, resulting in possible fire, explosion, severe personal injury, and death. Do not operate a generator set where a flammable vapor environment can be created, unless the generator set is equipped with an automatic safety device to block the air intake and stop the engine. The owners and operators of the generator set are solely responsible for operating the generator set safely. Contact your authorized Cummins distributor for more information.

Spillage

Any spillage that occurs during fueling, oil top-off, or oil change must be cleaned up before starting the generator set.

Fluid Containment

NOTICE

Where spillage containment is not part of a Cummins supply, it is the responsibility of the installer to provide the necessary containment to prevent contamination of the environment, especially water courses and sources.

If fluid containment is incorporated into the bedframe, it must be inspected at regular intervals. Any liquid present should be drained out and disposed of in line with local health and safety regulations. Failure to perform this action may result in spillage of liquids which could contaminate the surrounding area.

Any other fluid containment area must also be checked and emptied, as described above.

1.7 Batteries Can Explode

Batteries can explode, causing severe skin and eye burns and can release toxic electrolytes.

WARNING

Combustible Gases

Batteries can explode, causing severe skin and eye burns, and can release toxic electrolytes.

Do not dispose of the battery in a fire, because it is capable of exploding. Do not open or mutilate the battery. Do not charge frozen batteries.

⚠ WARNING***Electric Shock Hazard******Batteries present the risk of high short circuit current.******When servicing the generator set:***

- ***Remove watches, rings, or other metal objects.***
- ***Use tools with insulated handles.***

NOTICE**Serviceing of batteries must be performed or supervised by personnel knowledgeable of batteries and the required precautions. Keep unauthorized personnel away from batteries.**

- Wear safety glasses.
- Do not smoke.
- Do not charge frozen batteries.
- To prevent arcing when disconnecting the battery:
 1. Press the Off switch from the display and then press the E-Stop button.
 2. Disconnect AC power from any battery chargers.
 3. Remove the negative (-) battery cable to prevent starting.
- To prevent arcing when reconnecting the battery:
 1. Reconnect the positive (+) cable.
 2. Reconnect the negative (-) cable.
 3. Reconnect the battery charger to AC power supply.
- When replacing the generator set battery, always replace it with a battery as specified in this manual.

1.8 Exhaust Gases Are Deadly

- Provide an adequate exhaust system to properly expel discharged gases away from enclosed or sheltered areas, and areas where individuals are likely to congregate. Visually and audibly inspect the exhaust system daily for leaks per the maintenance schedule. Make sure that exhaust manifolds are secured and not warped. Do not use exhaust gases to heat a compartment.
- Make sure the unit is well ventilated.

Exhaust Precautions

WARNING

Hot Exhaust Gases

Contact with hot exhaust gases can cause severe burns.

Wear personal protective equipment when working on equipment.

WARNING

Hot Surfaces

Contact with hot surfaces can cause severe burns.

The unit is to be installed so that the risk of hot surface contact by people is minimized. Wear appropriate PPE when working on hot equipment and avoid contact with hot surfaces.

WARNING

Toxic Gases

Inhalation of exhaust gases can cause asphyxiation and death.

Pipe exhaust gas outside and away from windows, doors, or other inlets to buildings. Do not allow exhaust gas to accumulate in habitable areas.

WARNING

Fire Hazard

Contaminated insulation is a fire hazard. Fire can cause severe burns or death.

Remove any contaminated insulation and dispose of it in accordance with local regulations.

The exhaust outlet may be sited at the top or bottom of the generator set. Make sure that the exhaust outlet is not obstructed. Personnel using this equipment must be made aware of the exhaust position. Position the exhaust away from flammable materials - in the case of exhaust outlets at the bottom, make sure that vegetation is removed from the vicinity of the exhaust.

The exhaust pipes may have some insulating covers fitted. If these covers become contaminated they must be replaced before the generator set is run.

To minimize the risk of fire, make sure the following steps are observed:

- Make sure that the engine is allowed to cool thoroughly before performing maintenance or operation tasks.
- Clean the exhaust pipe thoroughly.

1.9 The Hazards of Carbon Monoxide

Carbon monoxide (CO) is an odorless, colorless, tasteless and non-irritating gas. You cannot see it or smell it. Red blood cells, however, have a greater affinity for CO than for oxygen. Therefore, exposure even to low levels of CO for a prolonged period can lead to asphyxiation (lack of oxygen) resulting in death. Mild effects of CO poisoning include eye irritation, dizziness, headaches, fatigue and the inability to think clearly. More extreme symptoms include vomiting, seizures and collapse.

Engine-driven generator sets produce harmful levels of carbon monoxide that can injure or kill you.

Special Risks of CO near the Home

WARNING

Toxic Gases

Carbon monoxide (CO) gas can cause nausea, fainting, or death. Residents can be exposed to lethal levels of CO when the generator set is running. Depending on air temperature and wind, CO can accumulate in or near the home.

To protect yourself and others from the dangers of CO poisoning, it is recommended that reliable, approved, and operable CO detector alarms are installed in proper locations in the home as specified by their manufacturer.

Protecting Yourself from CO Poisoning

- Locate the generator set in an area where there are no windows, doors, or other access points into the home.
- Make sure all CO detectors are installed and working properly.
- Pay attention for signs of CO poisoning.
- Check the exhaust system for corrosion, obstruction, and leaks every time you start the generator set and every eight hours when you run it continuously.

1.10 Earth Ground Connection

The neutral of the generator set may be required to be bonded to earth ground at the generator set location, or at a remote location, depending on system design requirements. Consult the engineering drawings for the facility or a qualified electrical design engineer for proper installation.

NOTICE

The end user is responsible to make sure that the ground connection point surface area is clean and free of rust before making a connection.

NOTICE

The end user is responsible for making sure that an earthing arrangement that is compliant with local conditions is established and tested before the equipment is used.

2 Introduction

2.1 Safety

 **WARNING**

Hazardous Voltage

Contact with high voltages can cause severe electrical shock, burns, or death.

Make sure that only a trained and experienced electrician makes generator set electrical output connections, in accordance with the installation instructions and all applicable codes.

 **WARNING**

Electrical Generating Equipment

Faulty electrical generating equipment can cause severe personal injury or death.

Generator sets must be installed, certified, and operated by trained and experienced person in accordance with the installation instructions and all applicable codes.

2.2 About This Manual

The purpose of this manual is to provide the users with sound, general information. It is for guidance and assistance with recommendations for correct and safe procedures. Cummins Inc. cannot accept any liability whatsoever for problems arising as a result of following recommendations in this manual.

The information contained within the manual is based on information available at the time of going to print. In line with Cummins Inc. policy of continuous development and improvement, information may change at any time without notice. The users should therefore make sure that they have the latest information available before starting any work. The latest version of this manual is available on QuickServe Online (<https://quickserve.cummins.com>).

Users are respectfully advised that, in the interests of good practice and safety, it is their responsibility to employ competent people to carry out any installation work. Consult your authorized dealer for further installation information. It is essential that the utmost care is taken with the application, installation, and operation of any generator set due to their potentially hazardous nature. Careful reference should also be made to other Cummins Inc. literature. You must operate and maintain your generator set properly if you are to expect safe and reliable operation.

For further assistance, contact your authorized Cummins dealer.

NOTICE

This device complies with part 15 of the FCC rules. Operation is subject to the following two conditions:

- This device may not cause harmful interferences.
- This device must accept any interference received, including interference that may cause undesired operation.

2.3 Schedule of Abbreviations

This list is not exhaustive. For example, it does not identify units of measure or acronyms that appear only in parameters, event/fault names, or part/accessory names.

AmpSentry, INSITE, and InPower are trademarks of Cummins Inc. PowerCommand is a registered trademark of Cummins Inc.

ABBR.	DESCRIPTION	ABBR.	DESCRIPTION
AC	Alternating Current	LED	Light-emitting Diode
AMP	AMP, Inc., part of Tyco Electronics	LTS	Long Term Storage
ANSI	American National Standards Institute	LVRT	Low Voltage Ride Through
ASOV	Automatic Shut Off Valve	MFM	Multifunction Monitor
ASTM	American Society for Testing and Materials (ASTM International)	Mil Std	Military Standard
ATS	Automatic Transfer Switch	MLD	Masterless Load Demand
AVR	Automatic Voltage Regulator	NC	Normally Closed
AWG	American Wire Gauge	NC	Not Connected
CAN	Controlled Area Network	NFPA	National Fire Protection Agency
CB	Circuit Breaker	NO	Normally Open
CE	Conformité Européenne	NWF	Network Failure
CFM	Cubic Feet per Minute	OEM	Original Equipment Manufacturer
CGT	Cummins Generator Technologies	OOR	Out of Range

ABBR.	DESCRIPTION	ABBR.	DESCRIPTION
CMM	Cubic Meters per Minute	OORH / ORH	Out of Range High
CT	Current Transformer	OORL / ORL	Out of Range Low
D-AVR	Digital Automatic Voltage Regulator	PB	Push Button
DC	Direct Current	PCC	PowerCommand® Control
DEF	Diesel Exhaust Fluid	PGI	Power Generation Interface
DPF	Diesel Particulate Filter	PGN	Parameter Group Number
ECM	Engine Control Module	PI	Proportional/Integral
ECS	Engine Control System	PID	Proportional / Integral / Derivative
EMI	Electromagnetic interference	PLC	Programmable Logic Controller
EN	European Standard	PMG	Permanent Magnet Generator
EPS	Engine Protection System	PPE	Personal Protective Equipment
E-Stop	Emergency Stop	PT	Potential Transformer
FAE	Full Authority Electronic	PTC	Power Transfer Control
FMI	Failure Mode Identifier	PWM	Pulse-width Modulation
FRT	Fault Ride Through	RFI	Radio Frequency Interference
FSO	Fuel Shutoff	RH	Relative Humidity
Genset	Generator Set	RMS	Root Mean Square
GCP	Generator Control Panel	RTU	Remote Terminal Unit
GND	Ground	SAE	Society of Automotive Engineers
LCT	Low Coolant Temperature	SCR	Selective Catalytic Reduction
HMI	Human-machine Interface	SPN	Suspect Parameter Number
IC	Integrated Circuit	SWL	Safe Working Load
ISO	International Organization for Standardization	SW_B+	Switched B+

ABBR.	DESCRIPTION	ABBR.	DESCRIPTION
LBNG	Lean-burn Natural Gas	UL	Underwriters Laboratories
LCD	Liquid Crystal Display	UPS	Uninterruptible Power Supply

2.4 Related Literature

Before any attempt is made to operate the generator set, the operator should take time to read all of the manuals supplied with the generator set, and to familiarize themselves with the warnings and operating procedures.

The literature provided with the generator set is as follows:

- Operator Manual (A051X877)
- Installation Manual (A051X873)

NOTICE
<p>A generator set must be operated and maintained properly if you are to expect safe and reliable operation. The Operator manual includes a maintenance schedule and a troubleshooting guide.</p> <p>The Health and Safety manual must be read in conjunction with this manual for the safe operation of the generator set:</p> <ul style="list-style-type: none"> • Health and Safety Manual (0908-0110) • Warranty Statement (A028U870) • <i>C45 N6, C50 N6 and C60 N6 models only: Emissions Component Defect Warranty Statement (A028X278)</i> • <i>C70 N6, C80 N6 and C100 N6 models only: Emissions Component Defect Warranty Statement (A028X279)</i>

The relevant manuals appropriate to your generator set are also available. The documents below are in English:

- Service Manual (A051X880)
- Parts Manual (A051X891)
- EControls, Inc., Global Control Platform (GCP) Software Service Manual (A035C596)
- EControls, Inc., 4G Software Service Manual (A052G032)
- EControls, Inc., GCP Engine Display Interface Software (EDIS) Training Manual (A035C608)
- EControls, Inc., 4G Software Operator Manual (A052G024)
- Engine Operation & Maintenance Manual for QSJ5.9G (4388606)
- RA Series Transfer Switch Owner Manual (A046S594) - if applicable

- PowerCommand® 1302 Controller Owner's Manual (900-0661)
- Service Tool Manual (A043D529)
- Standard Repair Times - HL Family (A053K365)
- T-030: Liquid Cooled Generator Set Application Manual (A040S369) - for application information

2.5 Model Specifications

NOTICE

Damage caused by failure to follow the manufacturer's recommendation will not be covered by the warranty. Please contact your authorized distributor.

TABLE 1. 5.9L MODEL VARIATIONS

Models	Description
C45 N6, C50 N6, C60 N6, C70 N6, C80 N6, C100 N6	60 Hz, 1800 RPM

TABLE 2. COLD WEATHER SPECIFICATIONS (ALL MODELS)

Temperature	Description	Battery Type	Group
Above 4 °C (40 °F)	Battery charger	Standard	34
-17 to 4 °C (0 to 40 °F)	Battery charger, coolant heater (1000W), CCV heater ¹	Standard	34
Below -17 °C (0 °F)	Battery charger, coolant heater (1500W), oil heater, battery heater, CCV heater ¹ , cold weather starter ²	Larger	4D

¹CCV heaters are provided as part of the cold and extreme cold coolant heater packages.

²The cold weather starter is provided as part of the extreme cold coolant heater package.

NOTICE

For NFPA 110 applications, a coolant heater is required. A factory option is available.

TABLE 3. FUEL SPECIFICATIONS 60 HZ, 1800 RPM

Type	Unit	C45 N6	C50 N6	C60 N6	C70 N6	C80 N6	C100 N6
Liquid Propane Full Load	scfh	289.6	321.6	370.2	384.2	420.8	518.7
	BTU/hr	651,600	723,600	832,950	864,450	946,800	1,167,075
Natural Gas Full Load	scfh	711.2	806.3	933.8	988.4	1,083.5	1,317.7
	BTU/hr	721,868	818,395	947,807	1,003,226	1,099,753	1,337,466
Fuel Pressure	6-13 inches of water column (1.5 - 3.2 kPa) under any condition						

TABLE 4. ENGINE SPECIFICATIONS (ALL MODELS)

Type	Specification
Engine	6 cylinder-in-line, single-cam, liquid-cooled, 4-stroke, spark ignited
Bore	102 mm 94.02 in)
Stroke	120 mm (4.72 in)
Displacement	5.88 L (359 in ³)
Compression Ratio (Natural Gas & LPG)	8.5:1
Firing Order	1-5-3-6-2-4
Spark Plug Gap 45, 50, 60 kW)	0.508 mm (0.020 in)
Spark Plug Gap (70, 80, 100 kW)	0.40 mm (016 in)
Spark Plug Torque	38 Nm (8 ft-lb)
Crankshaft Rotation (Viewed from the Front of the Engine)	Clockwise
Engine Weight (Dry, Long Block Only)	413 kg (911 lb)
Valve Clearance (Intake)	0.305 mm (0.012 in)
Valve Clearance (Exhaust)	0.610 mm (0.024 in)
Coolant	<ul style="list-style-type: none"> • 50/50 coolant solution (50% pure water and 50% anti-freeze) • 16 L (4.23 gal) capacity
Oil Capacity	15 L (4 gal)

Type	Specification
Oil Standards	<ul style="list-style-type: none"> • Must adhere to Cummins® Engineering Standard (CES) 20085 • Use of improper oils can result in engine damage. Use only the required oils: <ul style="list-style-type: none"> ◦ 5W-40 (all ambient temperatures) ◦ 15W-40 (above 4 °C [40 °F] ambient temperature) (use of GEO 15W-40 oil in ambient temperatures below 4 °C [40 °F] could result in engine turbocharger damage) • A sulfated ash limit of 0.6% mass has been placed on all engine lubricating oils recommended for use in Cummins® B, natural gas engines. Higher ash oils can cause valve and/or piston damage, cause spark plug fouling, and lead to excessive oil consumption and degradation of the catalyst.

TABLE 5. LUBRICATING OIL SYSTEM SPECIFICATIONS

Type	Specification
Lubricating Oil Pressure at Idle (Minimum)	104 kPa (15 psi)
Lubricating Oil Pressure at Rated Speed (Minimum)	
Filter Bypass Valve-Opening Pressure	311 kPa (45 psi)
Pressure Regulator Valve-Opening Pressure	449 kPa (65 psi)
Lubricating Oil Capacity (Standard Sump):	
--High	14.2 L (15 qt)
--Low	12.4 L (13 qt)
--Total System	15.1 L (16 qt)

TABLE 6. GENERATOR SET SIZE SPECIFICATIONS

Enclosure Type	Size (L x W x H)
Open/Weather	2489 x 1016 x 1473 mm (98 x 40 x 58 in); does not include exhaust discharge elbow
Sound Level 1	3023 x 1016 x 1473 mm (119 x 40 x 58 in)
Sound Level 2	3454 x 1016 x 1473 mm (136 x 40 x 58 in)

TABLE 7. GENERATOR SET WET WEIGHT (POUNDS) (60 HZ, 1800 RPM)

Configuration	C45 N6	C50 N6	C60 N6	C70 N6	C80 N6	C100 N6
Open	2180	2180	2431	2449	2587	2719
Weather	2359	2359	2610	2628	2766	2898
Sound Level 1	2455	2455	2706	2724	2862	2994
Sound Level 2	2485	2485	2736	2754	2892	3024

NOTICE

Weights are approximate and can be affected by selected options. Refer to outline drawings for specific weight information.

TABLE 8. ALTERNATOR SPECIFICATIONS 60 HZ, 1800 RPM

Type	C45 N6	C50 N6	C60 N6	C70 N6	C80 N6	C100 N6
Generator	Brushless, 4-pole rotating field, single bearing					
Power (kVA) 1 Phase	45	50	60	70	80	100
Power (kVA) 3 Phase	56.3	62.5	75	87.5	100	125
Rated Voltages (V)	120/240, 1 Ph					
	227/480, 3 Ph					
	347/600, 3 Ph					
	120/240, 3 Ph					
	120/208, 3 Ph					
	127/220, 3 Ph					
	F1PO (Reconnectable, Full Single Phase Output)					

NOTICE

Maximum $I_2 = 8\%$. Generator set load unbalance must not exceed 25% between any phases.

TABLE 9. GENERATOR SET DERATING GUIDELINES

Model	Phase	Engine Power Available Up To...		Derate At...	
		Elevation	Ambient Temperature	Elevation	Temperature
C45 N6	Both	675 m (2200 ft)	40 °C (104 °F)	4% per 300 m (985 ft)	2% per 10 °C (18 °F)
C50 N6	Both	150 m (490 ft)	25 °C (77 °F)		
C60 N6	Both	1000 m (3280 ft)	40 °C (104 °F)		
C70 N6	1	2575 m (8450 ft)			
	3	3048 m (10000 ft)			
C80 N6	1	1825 m (5985 ft)			
	3	2500 m (8200 ft)			
C100 N6	1	700 m (1560 ft)	25 °C (77 °F)		
	3	1000 m (3280 ft)	40 °C (104 °F)		

TABLE 10. CONTROL SPECIFICATIONS (ALL MODELS)

Control	Purpose
PC 1.1	Generator Set
Enovations I28 EPR	Engine (45, 50, 60 kW Generator Sets)
Enovations 4G LDI	Engine (70, 80, 100 kW Generator Sets)

TABLE 11. DC SYSTEM SPECIFICATIONS (ALL MODELS)

Type	Specification
Nominal Battery Voltage	12 VDC
Battery Group	34 standard, 4D high capacity (requires large battery tray)
Battery Type	Maintenance-free
Minimum Cold Crank Amps	850 standard, 1080 high capacity (requires large battery tray)

2.6 After Sales Services

Cummins offers a full range of maintenance and warranty services.

Maintenance

WARNING

Electrical Generating Equipment

Incorrect service or parts replacement can result in severe personal injury, death, and/or equipment damage.

Make sure service personnel are qualified to perform electrical and mechanical service.

For expert generator set service at regular intervals, contact your Cummins Inc. service provider. See power.cummins.com/sales-service-locator for service locations that service this application. Maintenance tasks should only be undertaken by trained and experienced technicians provided by your Cummins Inc. service provider.

Warranty

For details of the warranty coverage for your generator set, refer to the *Warranty Statement* listed in the Related Literature section.

Extended warranty coverage is also available. In the event of a breakdown, prompt assistance can normally be given by factory trained service technicians with facilities to undertake all minor and many major repairs to equipment on site.

For further warranty details, contact your authorized dealer.

NOTICE

Damage caused by failure to follow the manufacturer's recommendations will not be covered by the warranty. Please contact your authorized dealer.

Warranty Limitations

For details of the warranty limitations for your generator set, refer to the warranty statement applicable to the generator set.

How to Obtain Service

For parts, service, and product information, contact the nearest authorized Cummins Inc. dealer. To easily locate the nearest certified distributor/dealer for Cummins generator sets in your area, or for more information, contact us at 1-800-CUMMINS™ (1-800-286-6467) or visit <http://www.cummins.com/support>.

2.7 General Operating Conditions

The area surrounding the generator set is critical for safety and its performance. Follow the guidelines below.

- Do not stack anything on top of the generator set.

- Do not store anything inside of the generator set.
- Keep areas clear in front of the cool air in and hot air out (free of obstructions, debris, plants, etc.).

NOTICE

All maintenance procedures must be performed or supervised by authorized and trained service personnel only.

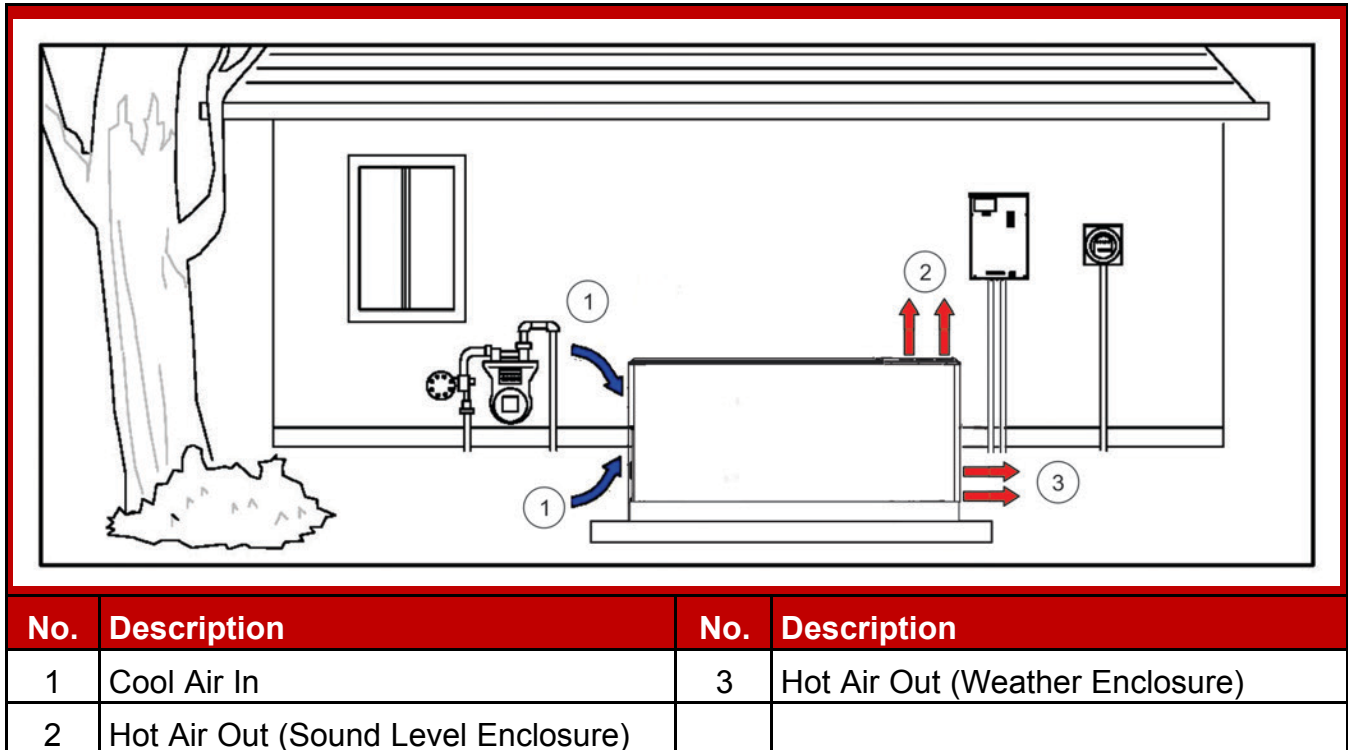

FIGURE 1. EXAMPLE OF GENERATOR SET LOCATION

2.8 Generator Set Nameplate

⚠ WARNING

Electrical Generating Equipment
Improper service or replacement of parts can lead to severe personal injury or death and to damage to equipment and property.
Make sure service personnel are qualified to perform electrical and mechanical service.

NOTICE

Unauthorized modifications or replacement of fuel, exhaust, air intake or speed control system components that affect engine emissions are prohibited by law in the State of California.

Model, Spec, and Serial Numbers: Be ready to provide the model, spec, and serial numbers on the generator set nameplate when contacting Cummins Inc. for information, parts, and service. The nameplate is located on the inside of the control access door on enclosed products or on the side of the radiator for open products.

Record these numbers so that they are easy to find when needed. Each character in these numbers is significant for obtaining the right parts listed in the Parts Catalog. Genuine Cummins Inc. replacement parts are recommended for best results.

My Generator Set Information

Model	
Spec	
Serial Number	

2.9 Manufacturing Facilities

Facility	Address	Phone Numbers
U.S. and CANADA	Cummins Inc. 1400 73rd Ave. NE Minneapolis, MN 55432 USA	Toll Free 1-800-CUMMINS™ (1-800-286-6467) Phone +1 763-574-5000 Fax +1 763-574-5298
EMEA, CIS	Cummins Inc. Columbus Avenue Manston Park Manston, Ramsgate Kent CT12 5BF United Kingdom	Phone +44 1843 255000 Fax +44 1843 255902
	Cummins Inc. Royal Oak Way South Daventry Northamptonshire NN11 8NU United Kingdom	Phone +44 1843 255000 Fax +44 1843 255902
ASIA PACIFIC	Cummins Inc. 10 Toh Guan Road #07-01 TT International Tradepark Singapore 608838	Phone +65 6417 2388 Fax +65 6417 2399
BRAZIL	Rua Jati, 310, Cumbica Guarulhos, SP 07180-900 Brazil	Phone +55 11 2186 4195 Fax +55 11 2186 4729
CHINA	Cummins Inc. 2 Rongchang East Street, Beijing Economic – Technological Development Area Beijing 100176, P.R. China	Phone 86 10 59023001 Fax +86 10 5902 3199
INDIA	Cummins Inc. Power Generation Business Unit, Plot No B-2, SEZ Industrial Area, Village-Nandal & Surwadi, Taluka- Phaltan Dist- Satara, Maharashtra 415523 India	Phone +91 021 66305514
LATIN AMERICA	3350 Southwest 148th Ave. Suite 205 Miramar, FL 33027 USA	Phone +1 954 431 551 Fax +1 954 433 5797

Facility	Address	Phone Numbers
MEXICO	Eje 122 No. 200 Zona Industrial San Luis Potosi, S.L.P. 78395 Mexico	Phone +52 444 870 6700 Fax +52 444 824 0082

3 Control System

3.1 Control System Description

The control system is used to start and stop the generator set, and provides full generator set monitoring capability and protection in a stand-alone situation (non-paralleling) from the display screen. It monitors the engine for temperature, as well as oil pressure and speed. It also provides voltage and current metering. In the event of a fault, the unit indicates the fault type and, on critical faults, automatically shuts down the generator set.

All indicators, control buttons, and the display screen are on the face of the operator panel, as illustrated in the figure below.

There are three fault level signals generated by the control system:

- **Event:** Signals that a temporary condition exists.
- **Warning:** Signals an imminent or non-critical fault for the engine. The control provides an indication only for this condition.
- **Shutdown:** Signals a potentially critical fault for the engine. The control immediately takes the engine off-load and automatically shuts it down.

The standard control system operates on 12 VDC (or 24 VDC if applicable) battery power. History data is stored in non-volatile memory and is not deleted if battery power is lost.

Standard Operator Panel

The operator panel includes indicator lights (LEDs), display buttons used to navigate through the menus, control mode buttons, and an LCD display. The display enables the operator to check the status, adjust the settings, and start and stop the generator set. The standard operator panel (shown below) is located on every generator set. An optional in-home operator panel accessory is also available for location inside the home.

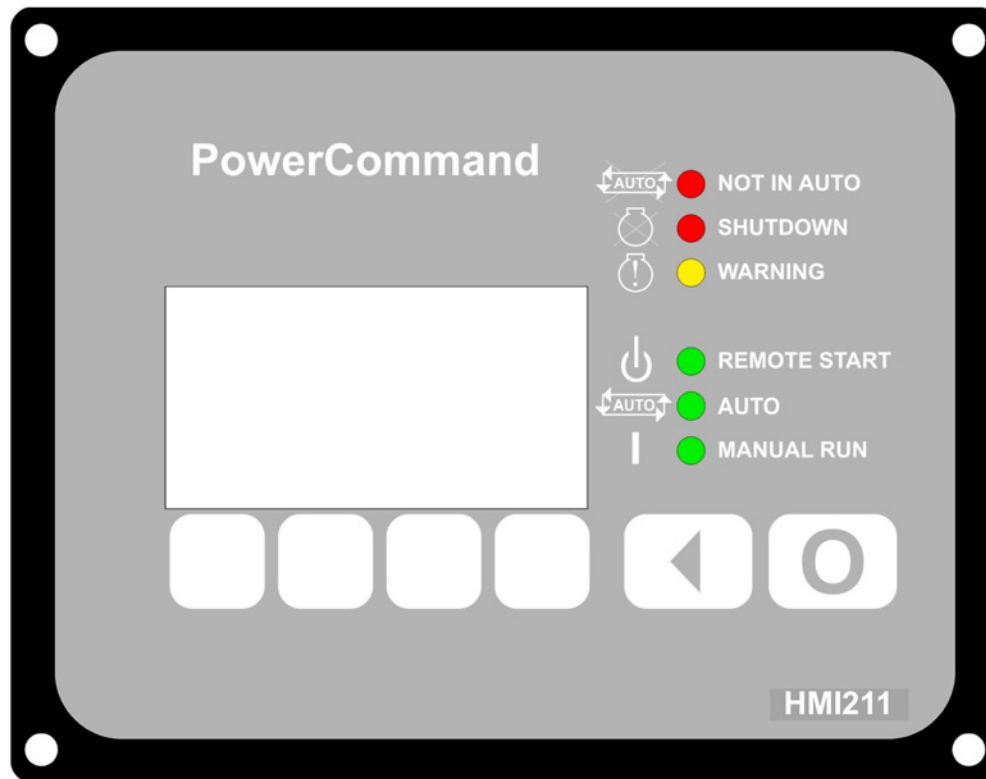

FIGURE 2. STANDARD OPERATOR PANEL (HMI211)

Standard Key Functions (HMI211)

The user interface includes two fixed action buttons and four soft key buttons. The action of the soft key buttons changes to meet the requirements of each screen.

TABLE 12. KEY FUNCTIONS

Key/Symbol	Action
○	Switches to Off mode (fixed action button).
↔AUTO↔	Switches to Auto mode.
☞	Switches to Manual Run mode.
◀	Navigates to the previous menu level (fixed action button).
▲	(Up Arrow) Navigates to the previous screen/menu in a list.
▼	(Down Arrow) Navigates to the next screen/menu in a list.
▲and ▼	Hold the up and down arrows simultaneously for two seconds from any Info Menu to navigate to the Menu screen.
Save	Saves changes and navigates to the associated screen.
Adjust	Navigates to the Adjust Menu of a specific menu.
→	(Right Arrow) Advances the highlighted field to the next editable field.

Key/Symbol	Action
-	Decreases value of the highlighted editable field.
+	Increases value of highlighted editable field.

Standard LED Indicators (HMI211)

The operator panel has six LED indicators. Colors, flashing frequency, and conditions to turn them on/off/blink are included in the table below.

TABLE 13. LED INDICATORS

LED	Color	Action
Not in Auto	Red	Indicates the generator set is in Manual or Off Mode.
Shutdown	Red	Indicates a Shutdown Fault has occurred.
Warning	Yellow	Indicates a Warning Fault has occurred.
Remote Start	Green	Indicates that the generator set has received a Remote Start Command.
Auto	Green	Indicates that the generator set is in Auto Mode. The generator starts when it receives a Remote Start Command.
Manual Run	Green	Indicates that the generator set has received a Manual Run Command.

In-Home Operator Panel (Accessory)

The in-home operator panel is an optional display that may be purchased. This panel is intended to serve as a convenience option to the standard operator panel mounted on the generator set.

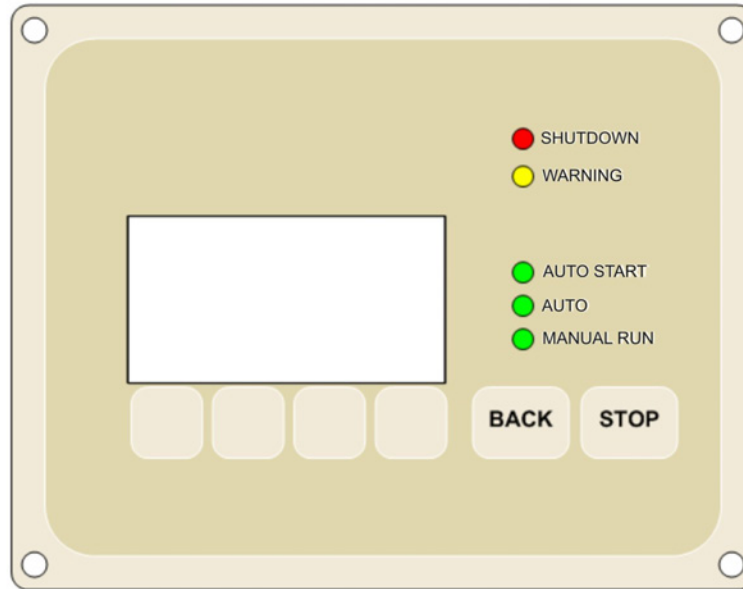

FIGURE 3. IN-HOME OPERATOR PANEL

Key Functions (In-Home Operator Panel)

The user interface includes two fixed action buttons and four soft key buttons. The action of the soft key buttons changes to meet the requirements of each screen.

TABLE 14. KEY FUNCTIONS

Key/Symbol	Action
Stop	Switches to Off mode. This key works from any screen (fixed action button).
▲	(Up Arrow) Navigates to the previous screen/menu in a list.
▼	(Down Arrow) Navigates to the next screen/menu in a list.
▲and ▼	Hold the up and down arrows simultaneously for two seconds from any Info Menu to navigate to the Service Menu.
Back	Navigates to the previous screen/menu in a list (fixed action button). In Adjust screens, settings are not saved.
Save	Saves changes and navigates to the associated screen.
Adjust	Navigates to the Adjust Menu of a specific menu.
→	(Right Arrow) Advances the highlighted field to the next editable field.
-	Decreases value of the highlighted editable field.
+	Increases value of highlighted editable field.

LED Indicators (In-Home Operator Panel)

The operator panel has five LED indicators. Colors, flashing frequency, and conditions to turn them on/off/blink are included in the table below.

TABLE 15. LED INDICATORS







LED	Color	Action
Shutdown	Red	Indicates a Shutdown Fault has occurred.
Warning	Yellow	Indicates a Warning Fault has occurred.
Auto Start	Green	Indicates that the generator set has received a Remote Start Command.
Auto	Green	Indicates that the generator set is in Auto Mode. The generator starts when it receives a Remote Start Command.
Manual Run	Green	Indicates that the generator set has received a Manual Run Command.









3.2 Display Text or Symbolic Version

The operator panel graphical display can be set to show text (English only) or symbols for fault messages, operator menus, and the Mode Change Menu. Descriptions of commonly used symbols are included in the following table. Combinations of symbols are used to display some fault conditions.

When shipped from the factory, the display is set to display symbols. Qualified service personnel are required to change the default setting.

TABLE 16. SYMBOLS

Symbol	Text
	Generator Warning Fault
	Generator Shutdown Fault
	Coolant Temperature
	Oil Pressure
	Voltage Alternating Current (VAC)
	Voltage Direct Current (VDC)
	AC Current
Hz	Frequency

Symbol	Text
	Battery
	Out of Range
	High or Pre-High
	Low or Pre-Low
	Annunciator
	Over Speed
	Crank Fail
	Emergency Stop

3.3 Exercise Settings

NOTICE

When battery power is lost, these settings must be reset.

NOTICE

Not applicable without an RA series transfer switch.

To access the Clock/Exerciser Menu:

1. From any Information Menu, hold down the up and down arrows simultaneously for two seconds. The Service Menu appears.
2. Navigate through the screens to find and select **Clock/Excr** in the Service Menu.

NOTICE

The following screens represent the standard operator panel (that is, HMI211). If using an in-home operator panel, which may be additionally purchased as an option, the screens may look slightly different. This procedure applies to both operator panels.

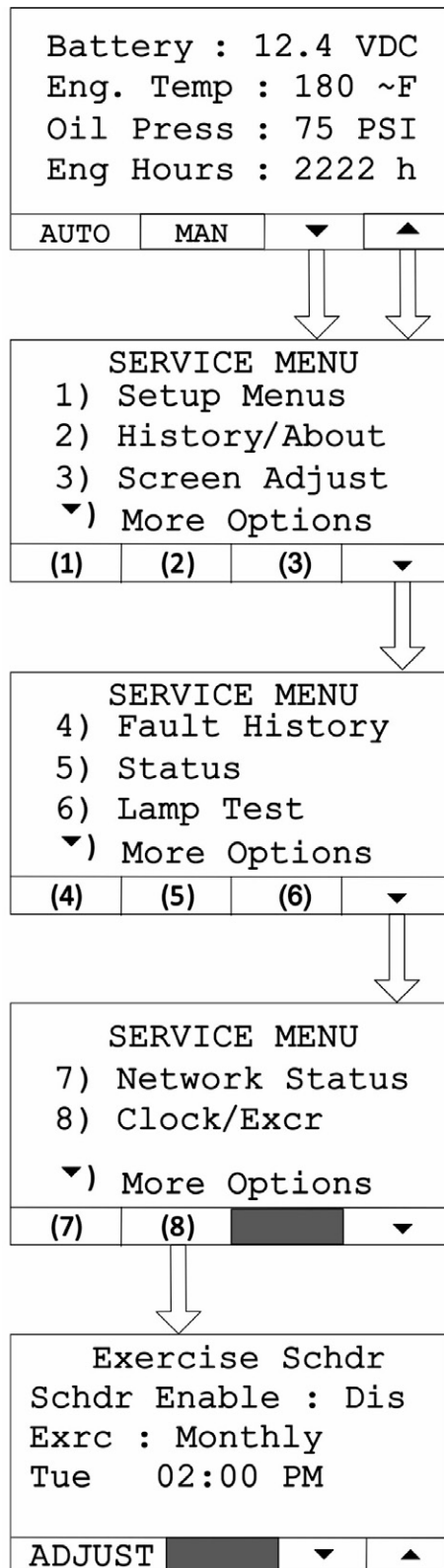

FIGURE 4. CLOCK/EXERCISER MENU NAVIGATION

Updating Exercise Frequency (3-Phase ATS)

NOTICE**Not applicable without an RA series transfer switch.**

To update the exercise frequency and dates on the Clock/Exerciser Menu:

1. From any Information Menu, hold down the up and down arrows simultaneously for two seconds. The Service Menu appears.
2. Access the Time Setup screen by selecting **Clock Exerciser** on the Genset Service Menu.
3. Press the down key on the Time Setup screen to access the Daylight Saving Adjust screen.
4. Select **Adjust**.
5. Press the down key on the Daylight Saving Adjust Start screen.
6. Select **Adjust**.
7. Press **Exercise Schdr** on the Daylight Saving Adjust End screen.
8. Press **Adjust**.

When updating these settings, the functions of the keys are as follows:

- The horizontal right arrow key is used to select successive blocks for editing settings on the screen.
- Use the + or - keys to edit the following settings:
 - Schdr Enable: Enable or Disable
 - Exercise Schedule: Semi-Annual (every six months), Quarterly, Monthly, Bi-Weekly (every two weeks) , or Weekly
 - Exercise Schedule: Day, Hours, Minutes, AM/PM
- Press **Save** to save any changes. After saving, the Save button changes to the Adjust button.

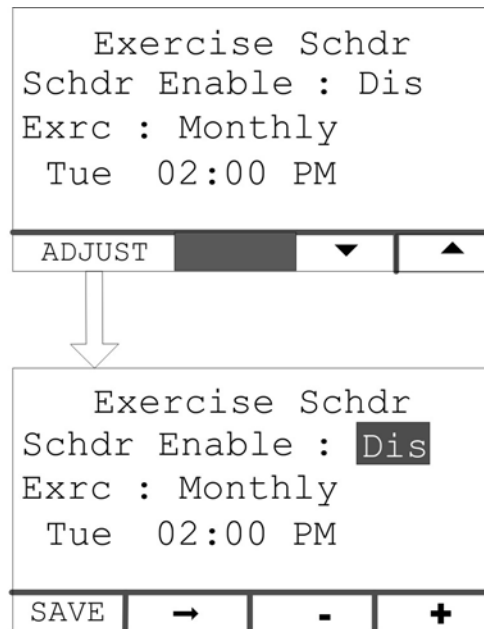

FIGURE 5. EXERCISE FREQUENCY NAVIGATION

Updating Exercise Duration (3-Phase ATS)

NOTICE

Not applicable without an RA series transfer switch.

To update the exercise duration on the Clock/Exerciser Menu:

1. From any Information Menu, hold down the up and down arrows simultaneously for two seconds. The Service Menu appears.
2. Access the Time Setup screen by selecting **Clock Exerciser** on the Genset Service Menu.
3. Press the down key on the Time Setup screen to access the Daylight Saving Adjust screen.
4. Select **Adjust**.
5. Press the down key on the Daylight Saving Adjust Start screen.
6. Select **Adjust**.
7. Press **Exercise Schdr** on the Daylight Saving Adjust End screen.
8. Press the down key on the Exercise Schdr Menu.
9. Press **Adjust**.

When updating these settings, the functions of the keys are as follows:

- The horizontal right arrow key is used to select the duration block for editing exercise duration.
- Use the + or - keys to edit the exercise duration minutes.

- Press **Save** to save any changes. After saving, the Save button changes to the Adjust button.

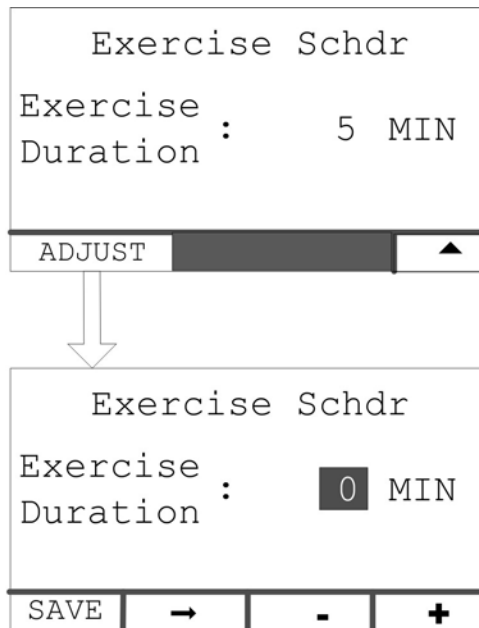

FIGURE 6. EXERCISE DURATION NAVIGATION

Time Setup (3-Phase ATS)

NOTICE

When battery power is lost, these settings must be reset.

NOTICE

Not applicable without an RA series transfer switch.

To set up the generator set clock for the current date and time:

1. From any Information Menu, hold down the up and down arrows simultaneously for two seconds. The Service Menu appears.
2. Access the Time Setup screen by selecting **Clock Exerciser** on the Genset Service Menu.
3. Select **Adjust**.

When updating these settings, the functions of the keys are as follows:

- The horizontal right arrow key is used to select successive blocks for editing settings on the screen.
- Select the left arrow to return to the previous screen.
- Adjust values by using the + or - keys on the Adjust Menu of the Time Setup screen.
- Press **Save** to save any changes. After saving, the Save button changes to the Adjust button.

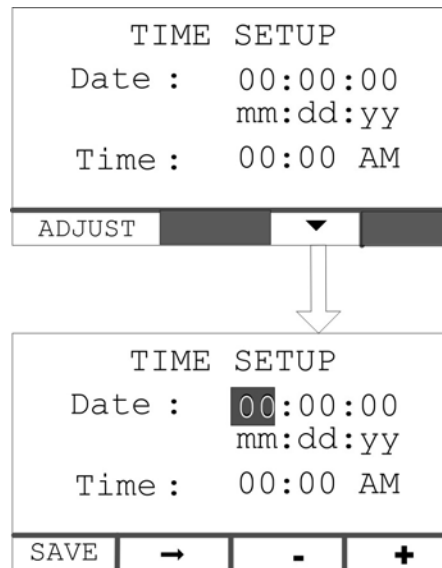

FIGURE 7. TIME SETUP SCREEN

Updating Daylight Saving Adjust Screens

Update Values on the Daylight Saving Adjust Screen

1. From any Information Menu, hold down the up and down arrows simultaneously for two seconds. The Service Menu appears.
2. Navigate to the Genset Service Menu.
3. Select **Clock Exerciser** to access the Time Setup screen.
4. Press the down key on the Time Setup screen to access the Daylight Saving Adjust screen.
5. Select **Adjust**. When updating these settings, the functions of the keys are as follows:

TABLE 17. KEY FUNCTIONS ON THE DAYLIGHT SAVING ADJUST SCREEN

Key/Button	Function
Horizontal right arrow key	Select successive blocks for editing settings on the screen
Left arrow key	Return to the previous screen
+ or - keys	Adjust values on the Adjust screen of the Daylight Saving Adjust screen
Save button	Save any changes; after saving, the Save button changes to the Adjust button

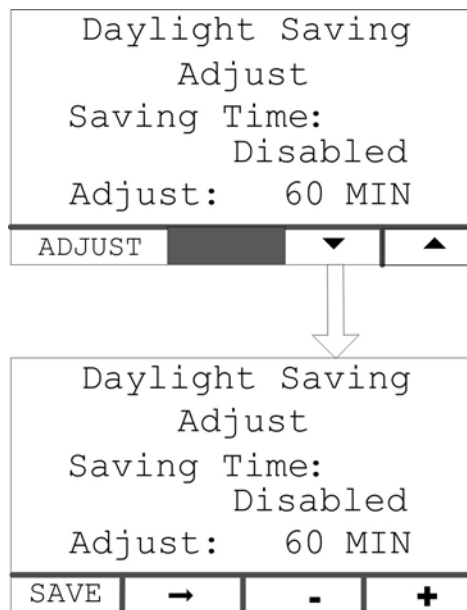

FIGURE 8. "DAYLIGHT SAVING ADJUST SAVING TIME" SCREEN NAVIGATION

Access and Update the Daylight Saving Adjust Start Screen

1. Press the down arrow key on the Daylight Saving Adjust screen.
2. Press **Adjust**. When updating these settings, the functions of the keys are as follows:

TABLE 18. KEY FUNCTIONS ON THE DAYLIGHT SAVING ADJUST START SCREEN

Key/Button	Function
Horizontal right arrow key	Select successive blocks for editing settings on the screen
+ or - keys	Adjust Month, Week, Day or Hour
Save button	Save any changes; after saving, the Save button changes to the Adjust button

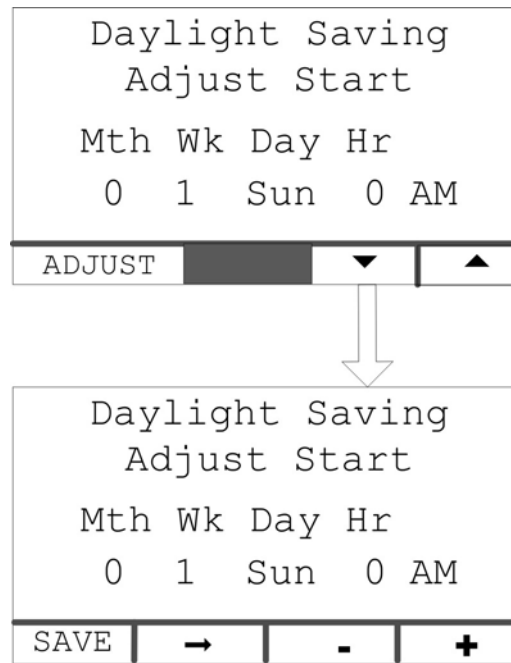

FIGURE 9. DAYLIGHT SAVING ADJUST START SCREEN

Update the Daylight Saving Adjust End Screen

1. Press the down key on the Daylight Saving Adjust Start screen.
2. Press **Adjust**. When updating these settings, the functions of the keys are as follows:

TABLE 19. KEY FUNCTIONS ON THE DAYLIGHT SAVING ADJUST END SCREEN

Key/Button	Function
Horizontal right arrow key	Select successive blocks for editing settings on the screen
+ or - keys	Adjust Month, Week, Day or Hour
Save button	Save any changes; after saving, the Save button changes to the Adjust button

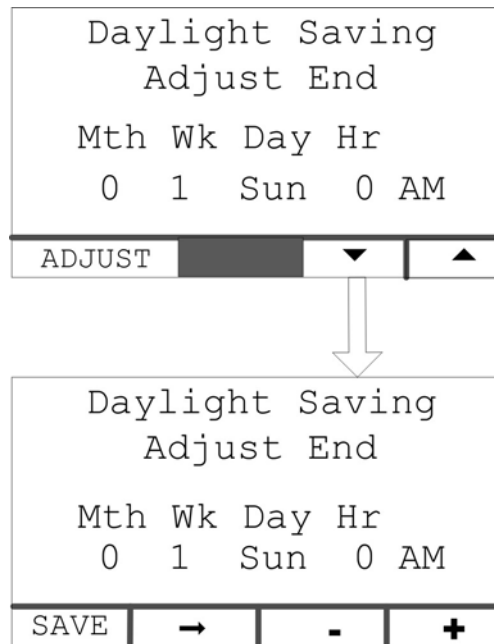

FIGURE 10. DAYLIGHT SAVING ADJUST END SCREEN

3.4 Brightness and Contrast

The Screen Adjust screen allows the contrast, brightness, and units to be set. To access the Screen Adjust screen:

1. From any Information screen, hold down the up and down arrows simultaneously for two seconds to gain access to the Service Menu screen.
2. Select **Screen Adjust**.

To adjust the contrast, brightness, or units from the Screen Adjust screen:

1. From the Screen Adjust screen, select **Adjust** to access the screen variables.
2. Press the right arrow to move between the variables.
3. Adjust settings, and press **Save** to save any changes.

When updating these settings, the functions of the keys are as follows:

- The horizontal right arrow key is used to select successive blocks for editing settings on the screen.
- Select the left arrow to return to the previous screen.
- Adjust values by using the + or - keys on the Adjust screen of the Display Setup screen.
- Press **Save** to save any changes. After saving, the Save button changes to the Adjust button.

NOTICE

The following screens represent the standard operator panel (HMI211). If using an in-home operator panel, which may be additionally purchased as an option, the screens may look slightly different. This procedure applies to both operator panels.

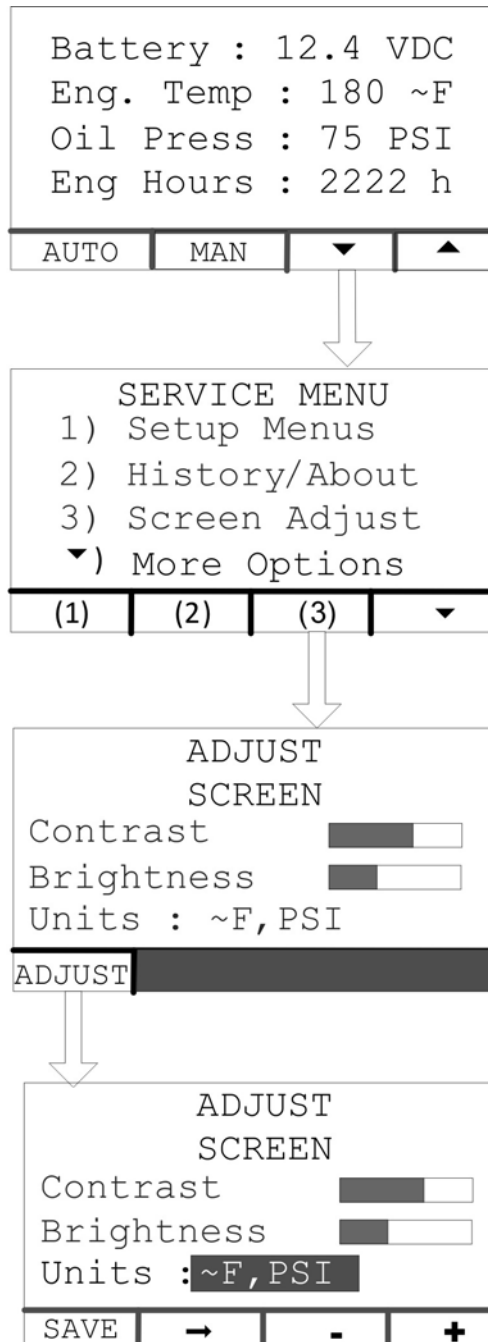

FIGURE 11. BRIGHTNESS AND CONTRAST SCREEN NAVIGATION

NOTICE

Adjusting the brightness on the operator panel adjusts the brightness of both the LCD backlight and the LEDs on the display. The contrast should never be 0 or 100% on any of the screens. The default value for Brightness is 50%.

3.5 History and About Menu

To access the History/About screen:

1. From any Information Menu, hold down the up and down arrows simultaneously for two seconds. The Service Menu appears.
2. Select **History/About**.
3. Advance through the screens to view information about the generator set, control, and display.

NOTICE

The following screens represent the standard operator panel (HMI211). If using an in-home operator panel, which may be additionally purchased as an option, the screens may look slightly different. This procedure applies to both operator panels.

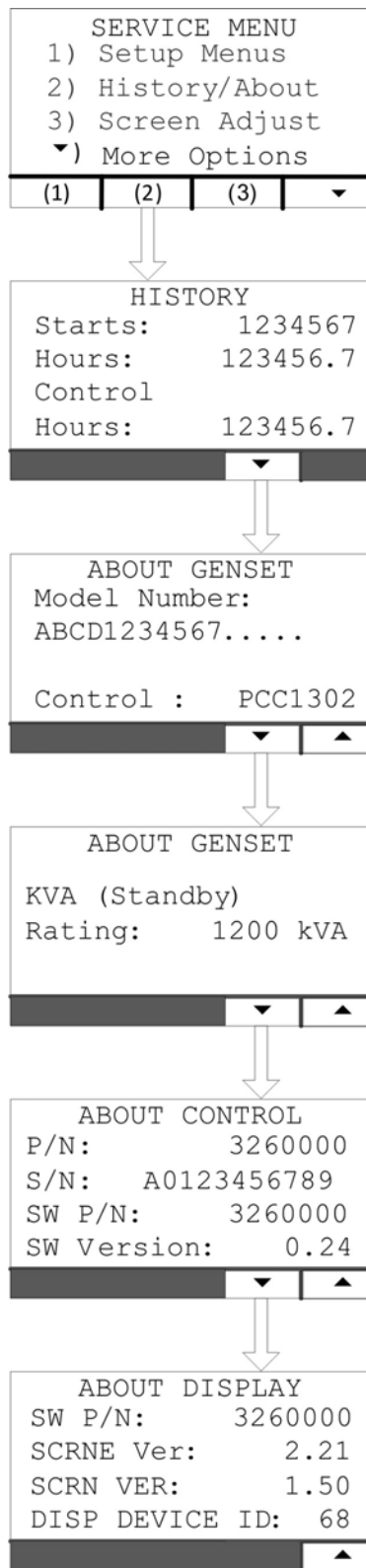

FIGURE 12. HISTORY/ABOUT MENU

3.6 Fault Log

To check the fault log:

1. From any Information Menu, hold down the up and down arrows simultaneously for two seconds. The Service Menu appears.
2. Select **Fault History**.

NOTICE

The active faults are displayed first. If there are no active faults, this screen is skipped. Following the Active Faults screen are the Fault History screens. These screens display the faults in chronological order from newest to oldest.

NOTICE

The following screens represent the standard operator panel (HMI211). If using an in-home operator panel, which may be additionally purchased as an option, the screens may look slightly different. This procedure applies to both operator panels.

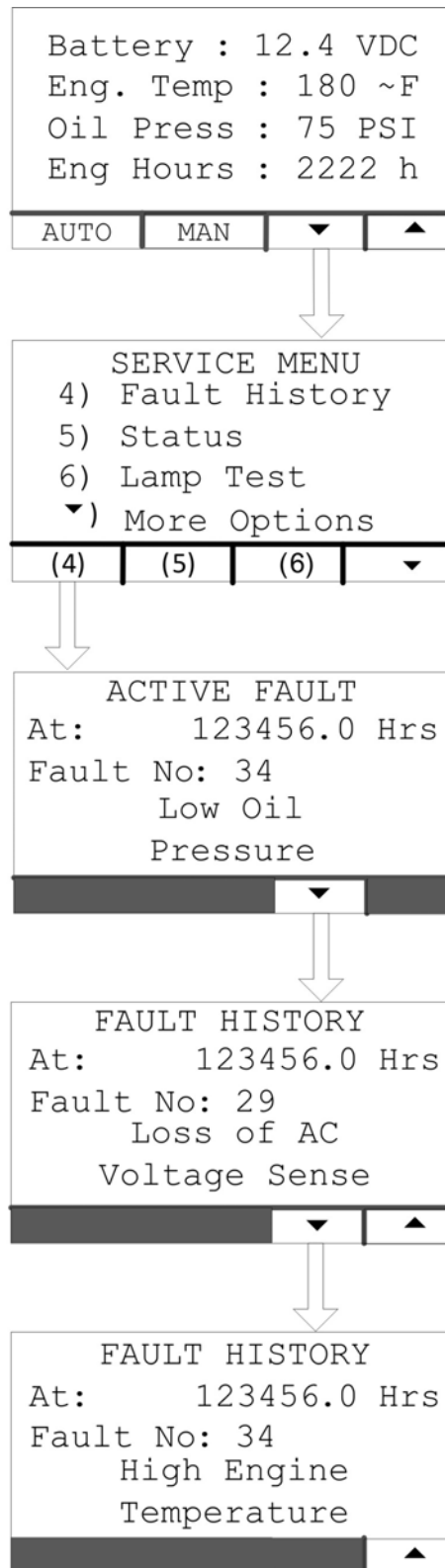

FIGURE 13. FAULT LOG SCREEN

3.7 Selecting Operating Modes





Selecting Manual Run Mode

WARNING

Electrical Generating Equipment

When changing modes, the generator set can start or stop without warning (for example, Auto Mode may have been selected with no mains (utility) power available).

Make sure there is no danger to personnel or equipment, if the generator set starts or stops when changing modes.

1. Before proceeding to change the mode, make sure that it is safe to do so.
2. Press the  Manual Run button on any of the Operator menus or the "Establishing/Re-establishing communication with control" menus.
3. If the Mode Change Access Code menu is enabled, the Mode Change Access Code is displayed. Enter the Mode Change Access Code.
4. A menu with alternating arrows is displayed above a second  symbol.
5. Press the second  Manual Run button, and the generator set will now begin the Manual start sequence. The Operator menu that was displayed before Manual Run mode was selected is re-displayed, but with the  symbol blacked out.

NOTICE

To disable Manual Run mode, press the Off button.

NOTICE

Auto mode can also be selected while in Manual Run mode. Switching to Auto mode may result in the generator set shutting down.

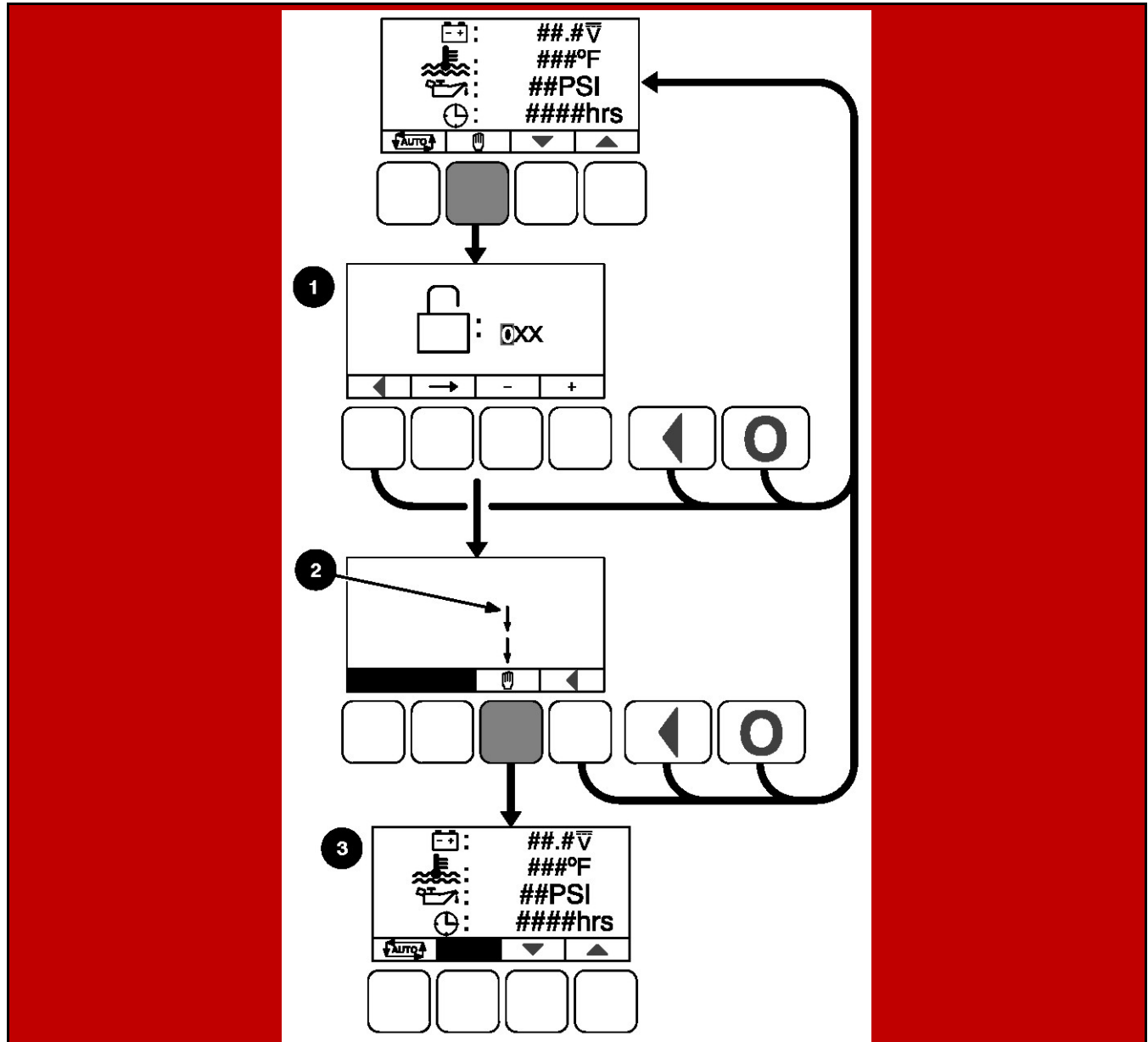

No.	Description	No.	Description
1	Menu Displayed Only When the Mode Change Access Code Feature Is Enabled	3	Manual Run Mode Selected
2	Alternating Arrows Displayed		

FIGURE 14. SELECTING MANUAL RUN MODE

Selecting Auto Mode





WARNING

Electrical Generating Equipment

When changing modes, the generator set can start or stop without warning (for example, Auto Mode may have been selected with no mains (utility) power available).

Make sure there is no danger to personnel or equipment, if the generator set starts or stops when changing modes.

To switch to Auto mode (see [Figure 15 on page 47](#)),

1. Ensure that it is safe to do so before proceeding to change the mode.
2. Press the  Auto button on any of the Operator menus, or the 'Establishing/Re-establishing communication with control' menus.
3. If the mode change access code feature is enabled, the Mode Change Access Code menu is displayed. Enter the Mode Change Access Code.
4. A menu with alternating arrows will then be displayed above a second  Auto symbol.
5. Press this second  Auto button. The Operator menu that was displayed before Auto mode was selected is re-displayed, but with the  Auto symbols blacked out and  Manual Run symbols visible.

To disable Auto mode, press the Off button.

The generator set is now ready to receive a remote start signal that will initiate the Auto run mode.

WARNING

Should a remote start signal be received, the generator set starts automatically. Make sure there is no danger to personnel or equipment should the generator set start without warning.

NOTICE

Manual Run mode can also be selected FROM Auto mode. Switching to Manual Run mode results in the generator set starting up.

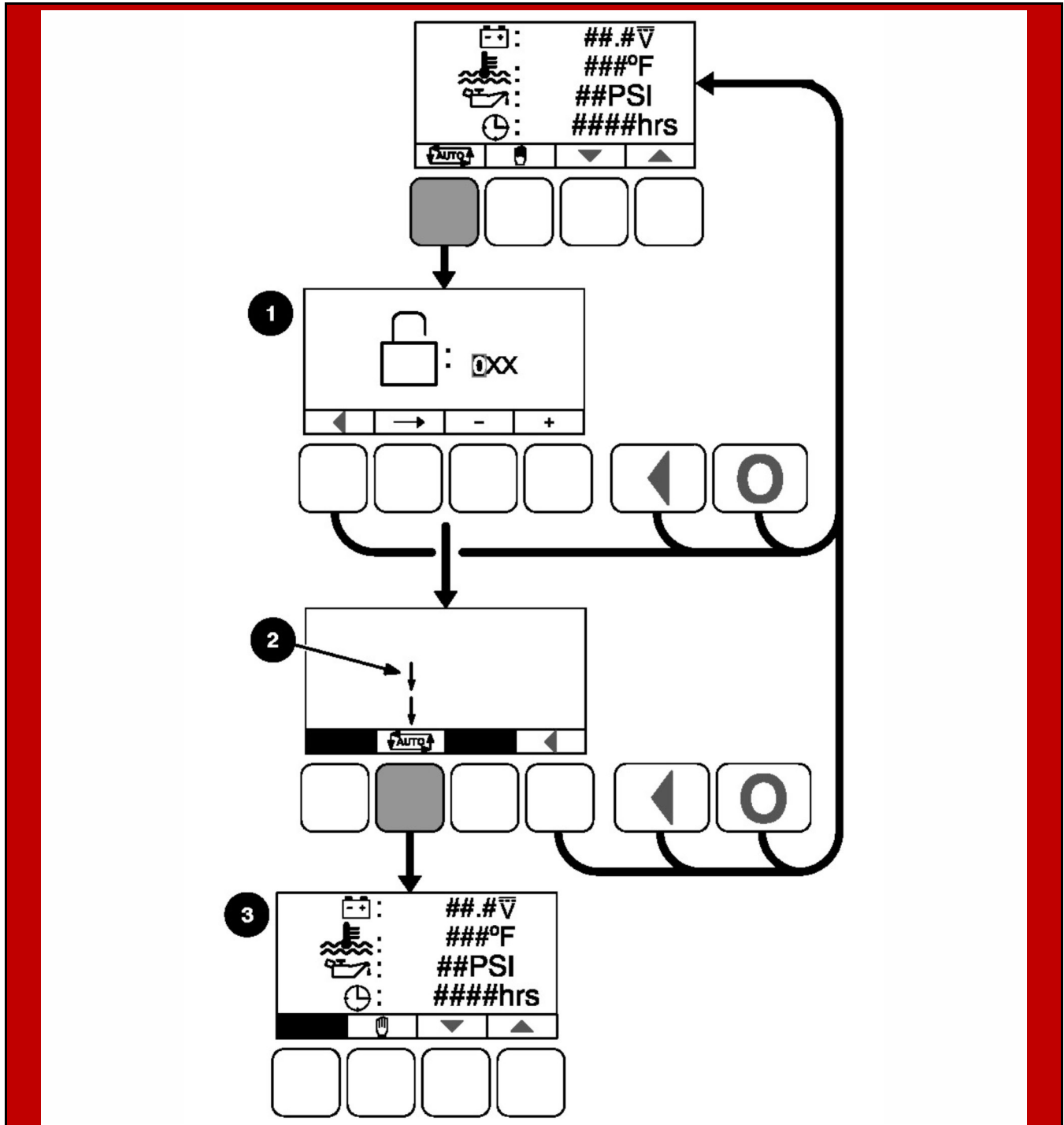

No.	Description	No.	Description
1	This Menu Is Displayed Only if the Mode Change Access Code Feature Is Enabled	3	Auto Mode Selected
2	Alternating Arrows Are Displayed		

FIGURE 15. SELECTING AUTO MODE

Selecting Off Mode

⚠ WARNING

Electrical Generating Equipment

When changing modes, the generator set can start or stop without warning (for example, Auto Mode may have been selected with no mains (utility) power available).

Make sure there is no danger to personnel or equipment, if the generator set starts or stops when changing modes.

To switch to Off mode (see the figure below),

1. Make sure that it is safe to do so before proceeding to stop the set.
2. Press the Off button on any of the Operator menu or the "Establishing/Re-establishing communication with control" menus.
3. If the Mode Change Access Code is enabled, the Mode Change Access Code will be displayed. Enter the Mode Change Access Code.
4. On entering the last correct digit, the basic screen will re-appear, and the set will stop without a Time Delay to Stop.

NOTICE

Make sure that there is no danger to personnel or equipment if the generator set is stopped.

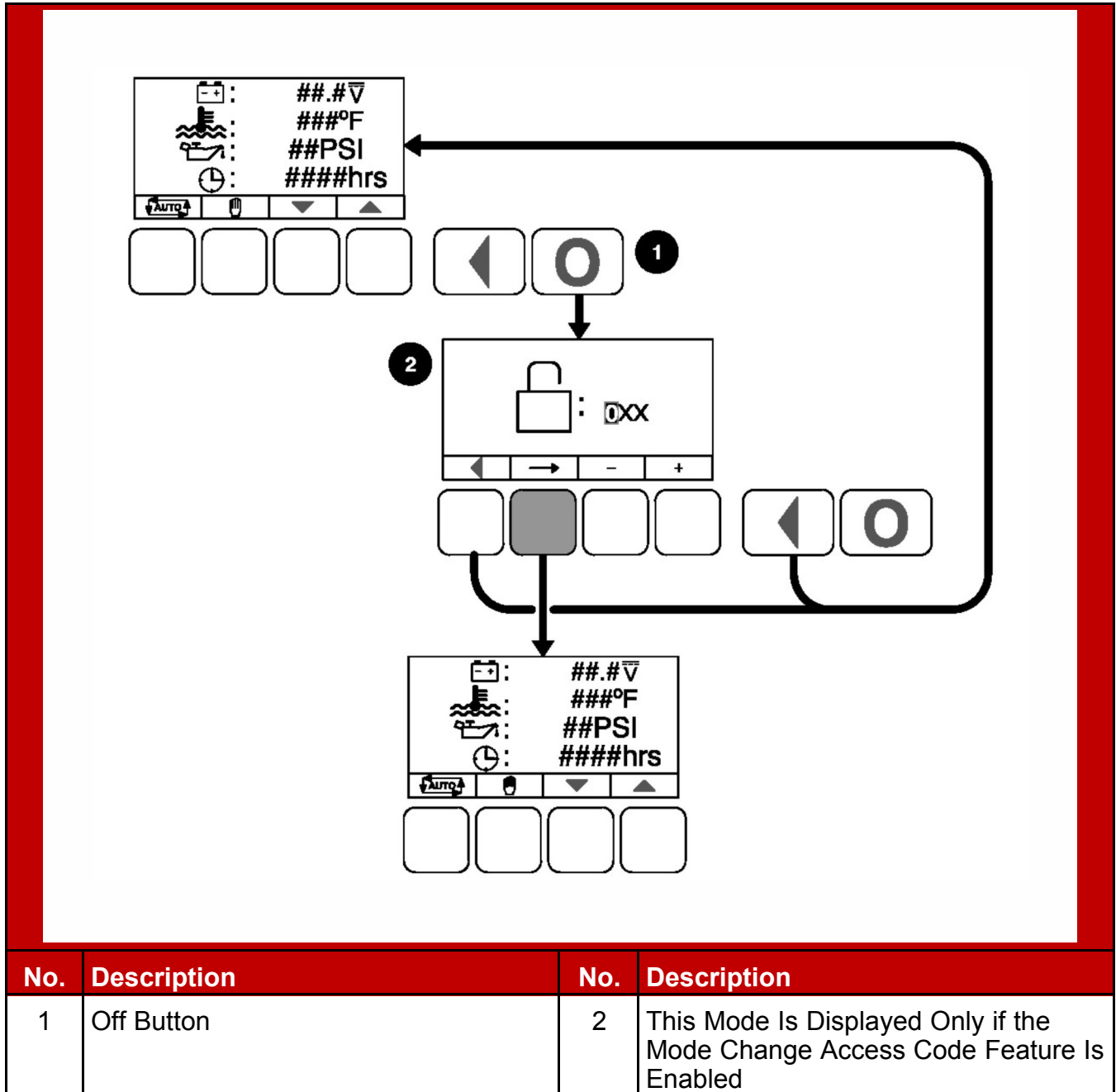

FIGURE 16. SELECTING OFF MODE

3.8 Operating Modes

The generator set's PowerCommand® control has **Manual Run**, **Off**, and **Auto** operating modes that are available from the operator panel.

Off Mode

When in Off mode, the control does not allow the generator set to start. If the generator set is already running and the control is set to Off, it initiates a normal shutdown sequence.

Manual Run Mode

When in Manual Run mode, the generator set starts and continues to run until the control is put into the Off mode. While in Manual Run mode, the remote start signal is ignored.

Auto Mode

When in Auto mode, the control allows the generator set to be started with a remote start signal only.

When in Auto mode, the generator set can start at any time. When a remote start signal is received, the genset starts after a time delay preheat (if programmed) and time delay start (if programmed) is completed.

If the generator set is running in Auto mode and the Off button is pressed, the control immediately stops the genset and the control transitions to the Off mode.

When all remote start signals are removed, the control performs a normal shutdown sequence which may include a time delay stop.

4 Operation - PowerCommand 1.1

4.1 Introduction

This section describes the operation of the generator set. The text should be read in conjunction with the Control System section of this manual.

All indicators, control switches/buttons, and graphical display are located on the face of the Operator Panel.

4.2 General Operating Conditions

The area surrounding the generator set is critical for safety and its performance. Follow the guidelines below.

- Do not stack anything on top of the generator set.
- Do not store anything inside of the generator set.
- Keep areas clear in front of the cool air in and hot air out (free of obstructions, debris, plants, etc.).

NOTICE

All maintenance procedures must be performed or supervised by authorized and trained service personnel only.

4.3 Generator Set Operation

WARNING

Combustible Vapors

Do not operate an engine where there are or can be combustible vapors. These vapors can be sucked through the air intake system and cause engine acceleration and overspeeding, which can result in a fire, an explosion, personal injury and extensive property damage.

Correct care of your engine will result in longer life, better performance, and more economical operation.

Cummins Inc. does not know how you will use your generator set. The equipment owner and operator, therefore, is responsible for safe operation in the installation site environment. Consult your authorized Cummins dealer for further information.

NOTICE

Diesel engines only: Cummins Inc. recommends the installation of an air intake shutoff device or a similar safety device to minimize the risk of overspeeding where an engine will be operated in a combustible environment.

NOTICE

Long periods of idling (more than ten minutes) can damage an engine. Do not idle the engine for excessively long periods.

Sequence of Operation

NOTICE

The following sequences are based on an approximate time duration. Your generator set may vary slightly from the timing diagrams in this manual. All referenced times are based on default control settings. The following sequences are applicable to generator sets connected to an RA series transfer switch.

Power Outage Sequence

The sequence of operation after a power outage (when the generator set is in Auto Mode) is as follows:

1. In normal operation, the utility power is running to the transfer switch and then to the building load, and the generator set is off.
2. The utility power turns off (power outage).
3. One second after the power outage, the transfer switch sends the command to the generator set to start.
4. If the ambient temperature is below 20 °F/-6.7 °C, the generator set will idle at 800 rpm for up to 2 minutes to allow sufficient turbo lubrication.
 - The set points are 20 °F/-6.7 °C and below, ramping linearly from 0 sec (20 °F/-6.7 °C) to 2 minutes (-40 °F/-40 °C) and held constant at 2 minutes if below -40 °F/-40 °C.

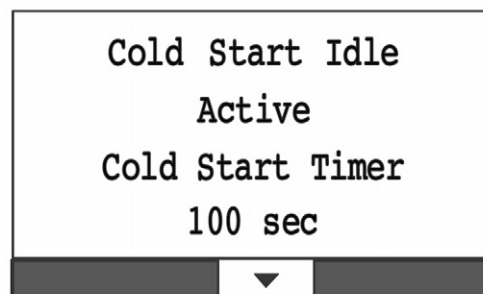

FIGURE 17. COLD START IDLE ACTIVE

NOTICE

The control box area is equipped with an ambient temperature sensor for controlling the idle feature. Do not install any heaters in the control box area as this can influence the sensor and lead to engine damage.

- 5. After the generator set ramps up to rated speed, the generator set provides voltage to the transfer switch, but the transfer switch does not switch (allowing the voltage to go to the building) until after a delay.

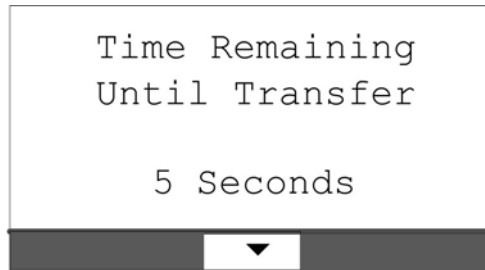

FIGURE 18. TIME REMAINING UNTIL TRANSFER SCREEN

- 6. Five seconds after starting, the generator set provides a signal to the transfer switch to transfer the building load to the generator set.

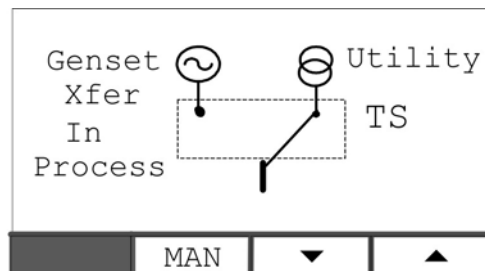

FIGURE 19. BUILDING LOAD TRANSFER IN PROCESS

- 7. The transfer switch switches the generator set power to the building load. The building is now running on generator power.

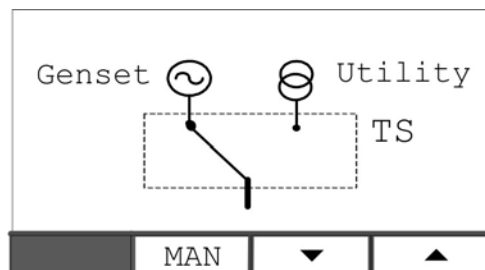

FIGURE 20. GENERATOR SET POWERING BUILDING LOAD

- 8. When the utility power is back and providing voltage to the transfer switch, the transfer switch waits for utility power stability.

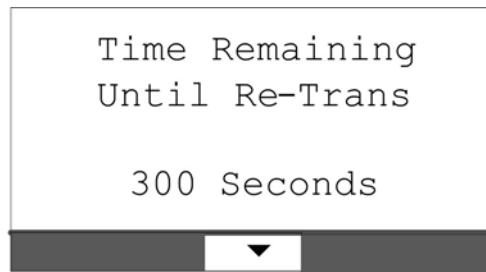

FIGURE 21. TIME REMAINING UNTIL RE-TRANSFER

9. When the utility power is stable for 5 minutes, the transfer switch switches back to utility power.

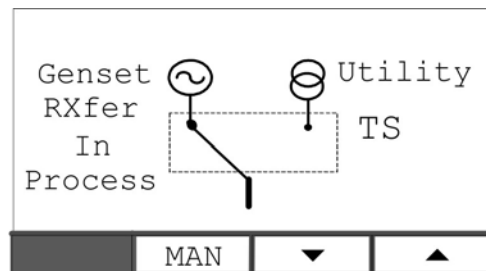

FIGURE 22. BUILDING LOAD TRANSFER IN PROCESS

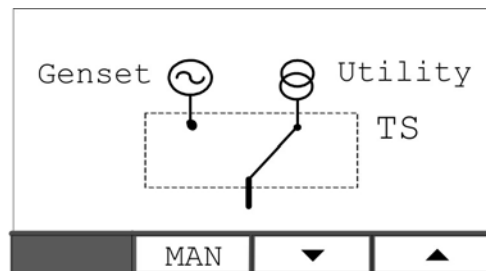

FIGURE 23. UTILITY POWERING BUILDING LOAD

10. The generator set runs for a 5-minute cooldown and shuts off.

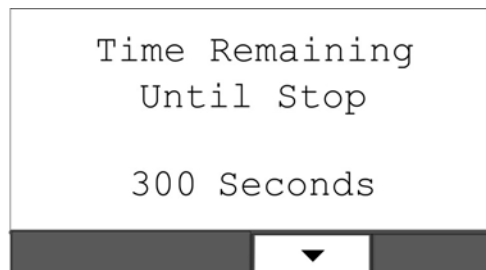

FIGURE 24. TIME REMAINING UNTIL STOP

11. Normal operation resumes.

Exercise Sequence

The exercise sequence when the programmed exercise time is realized (the generator set is in Auto Mode) is as follows:

1. The generator set starts and runs.

2. If the ambient temperature is below 20 °F (6.7 °C), the generator set will idle at 800 rpm for up to 2 minutes to allow sufficient turbo lubrication.
 - Idle time is linear from 2 minutes at -40 °F (4 °C), or below to off at 20 °F (6.7 °C) or above.

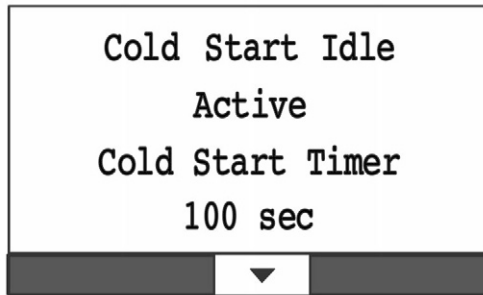

FIGURE 25. COLD START IDLE ACTIVE

3. The Exerciser Scheduler On screen displays every 3 seconds and toggles between the existing Information screen that is displayed for 1 second.

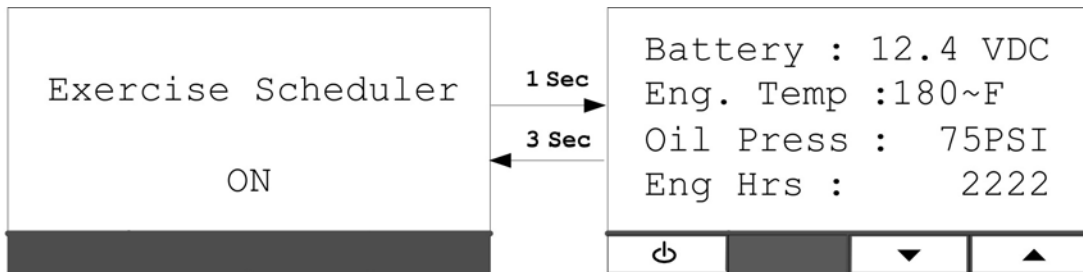

FIGURE 26. EXERCISER SCHEDULER SCREEN AND INFORMATION SCREEN TOGGLE - EXAMPLE

4. The transfer switch is not commanded to switch the building load to the generator set.

NOTICE

The user may navigate to other screens from the Information screens during this duration. No functional keys are active on the Exerciser Scheduler On screen.

5. The generator set stops after programmed exercise run time.

Manually Starting the Generator Set Sequence

If the generator set is manually started with the standard operator panel, HMI211 (the generator set is in Man Mode), the sequence is as follows:

NOTICE

Open the generator set main line circuit breaker to prevent the transfer switch from transferring building load to the generator set. The generator set display will still show the RA series ATS transfer; however, the switch will not transfer if the generator set breaker is open.

1. In normal operation, the utility power is running to the transfer switch and then to the building load, and the generator set is off.
2. Manually start the generator set via the standard control (HMI211) mounted on the generator set.

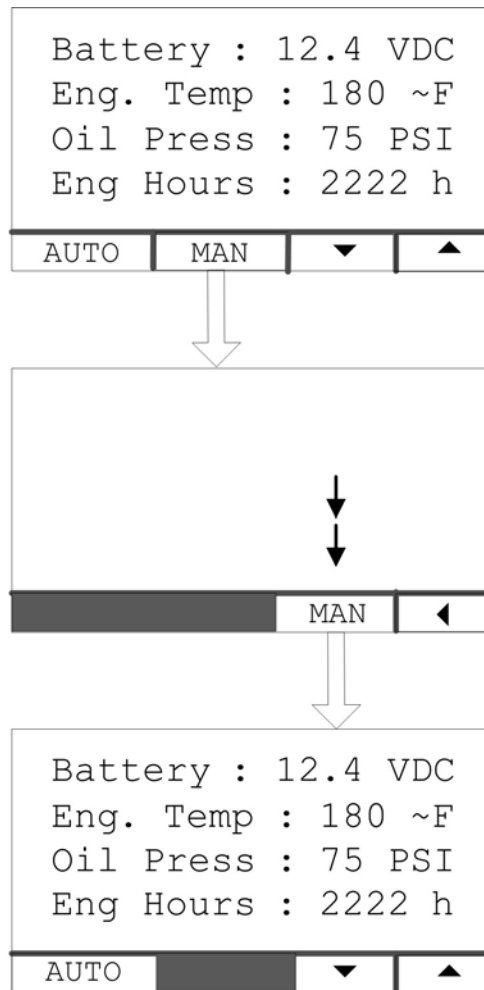

FIGURE 27. MANUAL START SCREEN, STANDARD OPERATOR PANEL

3. The generator set starts.
4. If the ambient temperature is below 20 °F (6.7 °C), the generator set will idle at 800 rpm for up to 2 minutes to allow sufficient turbo lubrication after which the generator will ramp up to rated speed.
 - Idle time is linear from 2 minutes at -40 F (4 °C), or below to off at 20 °F (6.7 °C) or above.

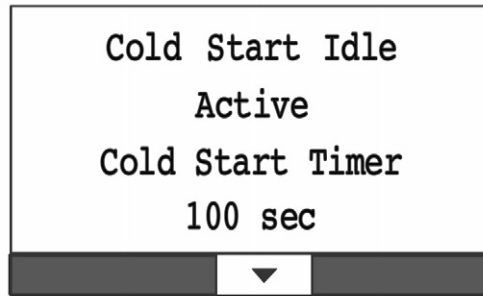

FIGURE 28. COLD START IDLE ACTIVE

5. The generator set provides voltage to the transfer switch. (However, the transfer switch does not transfer in manual mode.)

Remote Starting the Generator Set Sequence

If the generator set is remote started with the in-home operator panel accessory, if equipped (the generator set is in Auto Mode), the sequence is as follows:

1. In a normal operation, the utility power is running to the transfer switch and then to the building load, and the generator set is off.
2. The generator set-mounted control (HMI211) is set in Auto Mode.

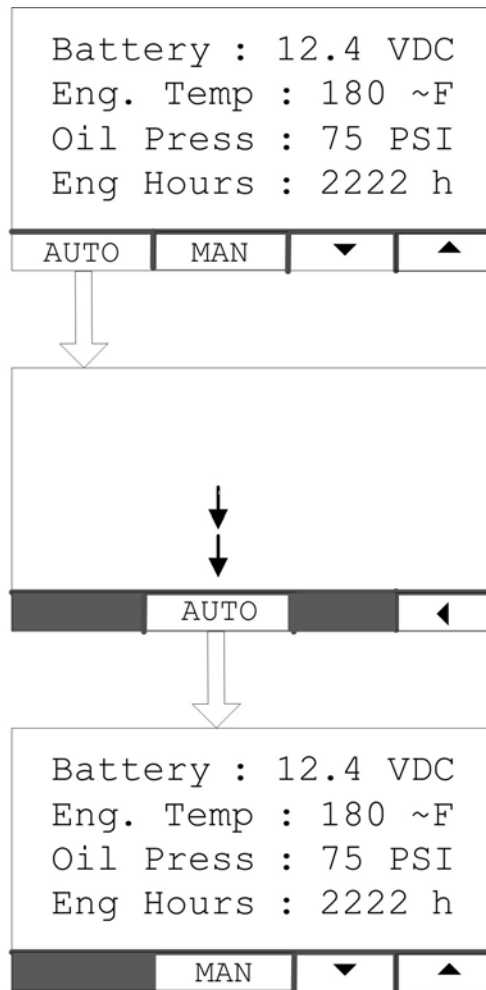

FIGURE 29. HMI211 SET IN AUTO MODE

3. Manually start the generator set via the in-home operator panel.

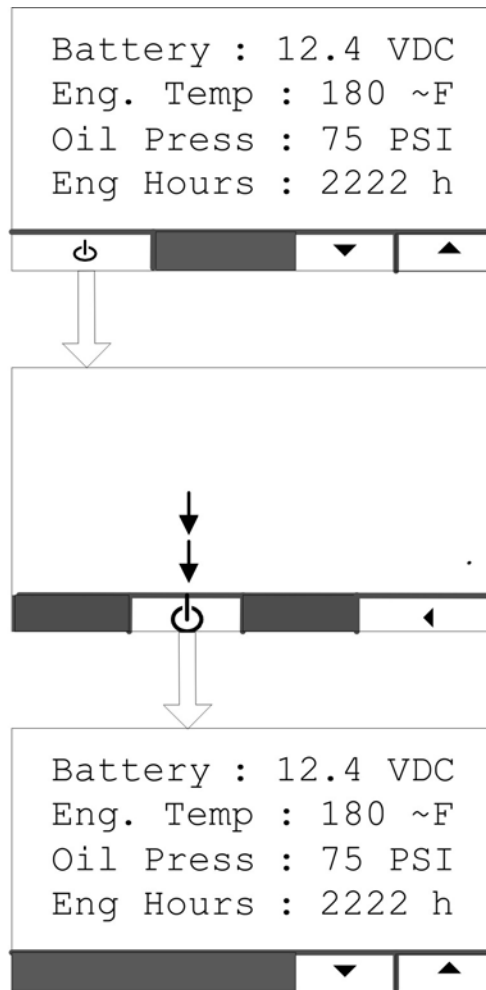

FIGURE 30. MANUAL START SCREEN, IN-HOME OPERATOR PANEL

- 4. The generator set starts and provides voltage to the transfer switch, but the transfer switch does not switch (allowing the voltage to go to the building) until after a delay.

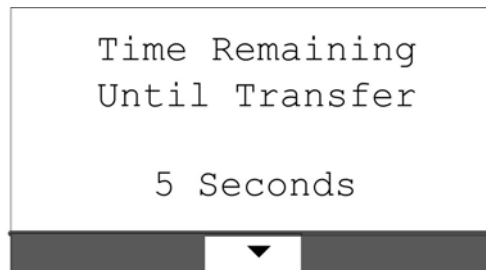

FIGURE 31. TIME REMAINING UNTIL TRANSFER SCREEN

- 5. Five seconds after starting, the generator set provides a signal to the transfer switch to transfer the building load to the generator set.

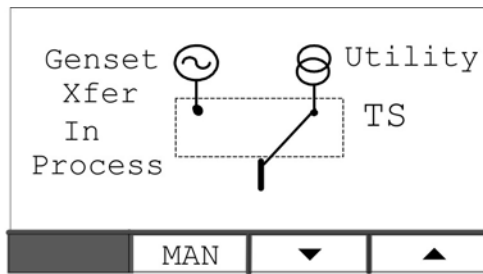

FIGURE 32. BUILDING LOAD TRANSFER IN PROCESS

6. If the ambient temperature is below 20 °F (6.7 °C) , the generator set will idle at 800 rpm for up to 2 minutes to allow sufficient turbo lubrication.
 - Idle time is linear from 2 minutes at -40 F (40 °C), or below to off at 20 °F (6.7 °C) or above.

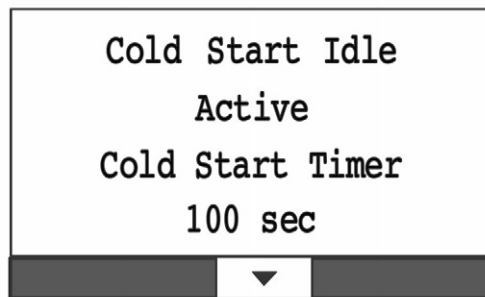

FIGURE 33. COLD START IDLE ACTIVE

7. The transfer switch switches the generator set power to the building load. The building is now running on generator power.

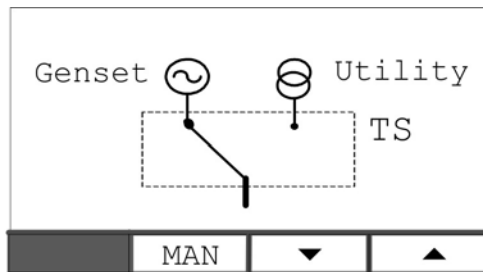

FIGURE 34. GENERATOR SET POWERING BUILDING LOAD

8. When the remote display Stop button is pressed, the transfer switch switches back to utility power after a 5 minute retransfer delay.

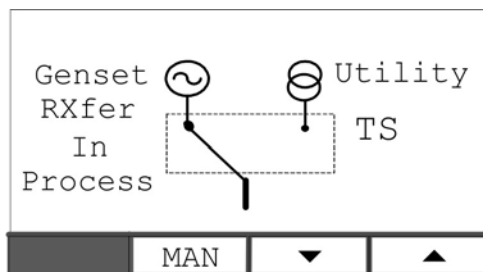

FIGURE 35. BUILDING LOAD TRANSFER IN PROCESS

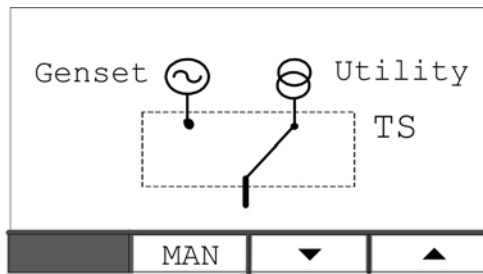

FIGURE 36. UTILITY POWERING BUILDING LOAD

9. The generator set runs for a 5-minute cooldown and shuts off.



FIGURE 37. TIME REMAINING UNTIL STOP

10. Normal operation resumes.

This page is intentionally blank.

5 Maintenance

5.1 Maintenance Safety

 **WARNING**

Automated Machinery

Accidental or remote starting of the generator set can cause severe personal injury or death.

Isolate all auxiliary supplies and use an insulated wrench to disconnect the starting battery cables (negative [-] first).

 **WARNING**

Hydrogen Gas

Arcing can ignite explosive hydrogen gas given off by batteries, causing severe personal injury or death. Arcing can occur when cables are removed or replaced, or when the negative (-) battery cable is connected and a tool used to connect or disconnect the positive (+) battery cable touches the frame or other grounded metal part of the generator set.

Insulated tools must be used when working in the vicinity of the batteries. Always remove the negative (-) cable first and reconnect last.

 **WARNING**

Explosive Fumes

Arcing can ignite explosive fumes causing severe personal injury or death.

Make sure hydrogen from the battery, engine fuel and other explosive fumes are fully dissipated before working on the generator set.

 **WARNING**

Working at Heights

Using the incorrect equipment when working at heights can result in severe personal injury or death.

Suitable equipment for performing these tasks must be used in accordance with the local guidelines and legislation. Failure to follow these instructions can result in severe personal injury or death.

⚠ WARNING**Access**

Using the generator set or part of as a means of access when attaching lifting shackles, chains, or other lifting aids, may damage the generator set, causing severe personal injury or death.

Do not use the generator set as a means of access. Failure to follow these instructions can result in severe personal injury or death.

⚠ WARNING**Exposed Terminations**

Some panel internal components may have live exposed terminations even if the generator set is not running. Voltages are present which can cause electrical shock, resulting in personal injury or damage to equipment.

Isolate all external electrical supplies prior to access of the control panel

NOTICE

Only authorized and qualified maintenance technicians who are familiar with the equipment and its operation should carry out maintenance.

NOTICE

Dependent upon the control system fitted, this unit may operate automatically and could start without warning.

NOTICE

Always disconnect a battery charger from its AC source before disconnecting the battery cables. Failure to do so can result in voltage spikes high enough to damage the DC control circuits of the generator set.

All maintenance tasks must be performed, but be sure to assess them for health and safety risks before starting. For example, perform a task with someone present if doing so will add significantly to the safety of the task.

Read, understand, and comply with all Caution, Warning, and Danger notes in this section, the Important Safety Instructions section, and the documentation supplied with the generator set.

Make sure that adequate lighting is available.

Locking the Generator Set Out of Service

NOTICE

Automated Machinery

Accidental or remote starting of the generator set can cause severe personal injury or death.

Isolate all auxiliary supplies and use an insulated wrench to disconnect the starting battery cables, negative (–) cable first.

Before any work is carried out for maintenance, etc., the generator set must be immobilized. Even if the generator set is put out of service by pressing the Off switch on the Operator Panel (or the STOP button if applicable), the generator set cannot be considered safe to work on until the engine is properly immobilized, as detailed in the following procedure.

NOTICE

Refer also to the engine-specific Operator Manual, if applicable. This manual contains specific equipment instructions that may differ from the standard generator set.

To immobilize the generator set:

1. Press the Off switch from the display and then press the E-Stop button to shut down the engine. This will prevent the starting of the generator set regardless of the Start signal source and will therefore provide an additional safety step for immobilizing the generator set. Alternatively, make sure the generator set is in manual mode (which allows it to be started by manually pushing the buttons).

NOTICE

When the E-Stop button is pressed, the Operator Panel indicates the Shutdown condition by illuminating the red Shutdown status LED  and displaying a message on the graphical LCD display.

2. Thoroughly ventilate the generator set before disconnecting any leads.
3. Turn off and disconnect the heater (where fitted) from the AC source before disconnecting the battery cables.
4. Turn off and disconnect the battery charger (where fitted) from the AC source before disconnecting the battery cables.
5. Turn off the fuel supply to the engine.
6. Disconnect the battery. Disconnect the negative (–) cable first, using an insulated wrench.
7. Place warning notices at each of the above locations that state, "Maintenance in Progress – Immobilized for Safe Working."

5.2 Periodic Maintenance

 **WARNING**

Electrical Generating Equipment

Accidental or remote starting of the generator set can cause severe personal injury or death.

Before working on the generator set, make sure that the generator set is in Off mode, disable the battery charger, and remove the negative (-) battery cable from the battery to prevent starting.

The table(s) that follow show the recommended service intervals for a generator set on standby service. If the generator set will be subjected to extreme operating conditions, the service intervals should be reduced accordingly.

At each scheduled maintenance interval, perform all previous maintenance checks that are due for scheduled maintenance.

Some of the factors that can affect the maintenance schedule are:

- Extremes in ambient temperature
- Exposure to elements
- Exposure to salt water
- Exposure to windblown dust or sand

Consult with your authorized Cummins Inc. service provider if the generator set will be subjected to any extreme operating conditions, and determine if extra protection or a reduction in service intervals is needed. Use the engine hours shown on the system status screen to keep an accurate log of all service performed for warranty support. Perform all service at the time period indicated, or after the number of operating hours indicated, whichever comes first.

Repair or replace worn, damaged, or improperly functioning components identified during periodic maintenance procedures.

Periodic Maintenance Guidelines

Regularly performing the following periodic maintenance tasks greatly reduces the chances of a generator set shutdown:

- Maintain an appropriate oil level.
- Keep battery connections clean and tight.
- Do not overload the generator set.
- Keep the air inlet and outlet openings clear.

Periodic Maintenance Schedule

NOTICE

Perform maintenance tasks as specified using daily or hourly periods, whichever is sooner.

TABLE 20. PERIODIC MAINTENANCE SCHEDULE

Maintenance Items	After Every 24 Hours of Run Time ¹	After Every 50 Hours of Run Time	12 Months or After 250 Hours ²	2 Years or After 500 Hours ²
Check air cleaner restriction indicator (where fitted): If the indicator shows red, replace air cleaner element and reset the indicator.	■			
Check air intake system for leaks: Visually inspect for signs of wear or damage. Check audibly when the generator set is running. Replace worn or damaged components.	■			
Check coolant level of radiator: If low, top up to coolant system specifications level, with Cummins recommended coolant mix.	■			
Check cooling fan blades: Visually inspect the blades through the guarding for signs of wear or damage. To replace, contact your authorized distributor.	■			
Checking drive belt condition and tension: Visually check belt for evidence of wear or slippage. To replace, contact your authorized distributor.	■			

Maintenance Items	After Every 24 Hours of Run Time ¹	After Every 50 Hours of Run Time	12 Months or After 250 Hours ²	2 Years or After 500 Hours ²
Check radiator airflow: Visually inspect the radiator through the guarding for blockage, debris or signs of wear or damage. To clean or replace, contact your authorized distributor.	■			
Check fuel lines and hoses: Visually check for leaks, worn or damaged hoses. To replace, contact your authorized distributor.	■			
Check engine oil level: If low, top up to engine specifications level with recommended oil.	■			
Check charge alternator: Check visually and audibly when the generator set is running. To replace, contact your authorized distributor.	■			
Check all exhaust components and hardware (fittings, clamps, fasteners, etc.): Visually inspect the exhaust system for signs of wear or damage. Check audibly when the generator set is running.	■			
Check generator set enclosure: Visually check enclosure. Make sure no inlets/outlets are restricted, service access doors are operational. To replace damaged parts, contact your authorized distributor.	■			
Check operation of operator panel: Check display (the system will perform a control panel test on initial activation). Replace component if not functioning properly.	■			

Maintenance Items	After Every 24 Hours of Run Time ¹	After Every 50 Hours of Run Time	12 Months or After 250 Hours ²	2 Years or After 500 Hours ²
Check operation of Emergency Stop Button (where fitted): With the generator set running, press the Emergency Stop button. Check all systems before resetting the fault.		■		
Replace air cleaner.			■ ³	
Check coolant lines and radiator hoses for leaks, wear and cracks: Visually check the hoses. Replace worn or damaged components.			■	
Clean radiator core.			■ ³	
Check water pump for leaks. Check weep holes for evidence of leaks. Replace if leaking.			■	
Verify that the coolant heater has power and is running (where fitted). Check for evidence of leaks. Remove any corrosion from fittings.			■	
Check CCV heater (where fitted). Check for evidence of leaks. Remove any corrosion from fittings.			■	
Check alternator heater (where fitted). Check general condition and wiring connections.			■	
Check battery heater (where fitted). Check general condition and wiring connections.			■	
Check engine oil heater (where fitted). Check general condition and wiring connections.			■	
Check battery: Check connections to verify that they are secure.			■	

Maintenance Items	After Every 24 Hours of Run Time ¹	After Every 50 Hours of Run Time	12 Months or After 250 Hours ²	2 Years or After 500 Hours ²
Check battery for general condition. Remove any corrosion on terminals with wire brush.			■	
Check electrical connections (battery, starter motor, alternator connections). Check for tight connections, general condition and remove any corrosion.			■	
Replace engine oil and filters. Refer to the Engine Oil section for the procedure.		■ ⁴	■ ⁴	
Check engine ground. Clean as necessary.			■	
Check engine mounts for general condition and for signs of excessive wear.			■	
Check starting motor.			■	
Check turbocharger for signs of leakage. Listen for excessive noise when test running the generator set.			■	
Inspect spark plugs. Replace if showing signs of excessive wear, carbon deposits, oil accumulation or damaged.			■	
Replace spark plugs and spark plug wires.				■
Check charge air cooler for damage and debris.			■	
Check valve lash and adjust if required. See the Valve Clearance Adjustment procedure (service manual only).				■
Check fan drive idler arm and fan belt tensioner for general condition, as well as for excessive play in both.				■

Maintenance Items	After Every 24 Hours of Run Time ¹	After Every 50 Hours of Run Time	12 Months or After 250 Hours ²	2 Years or After 500 Hours ²
Replace cooling system coolant. Check coolant sensor for damage and debris.				■
<p>¹ This interval is based on generator run time: daily in an outage or after every 24 hours of run time.</p> <p>² To be performed by a qualified Service Technician.</p> <p>³ Cleaning schedule may be reduced depending on operating conditions/environment.</p> <p>⁴ After the initial 50 hour interval and every 250 hours thereafter.</p>				

5.3 Exercising the Generator Set

NOTICE

Audible engine RPM variation may be heard when there is no load applied. This is normal and does not affect the generator set performance.

Exercising the generator set drives off moisture, relubricates the engine, and removes oxides from electrical contacts. The result is better starting, more reliable operation and longer engine life.

The generator set exerciser mode defaults are as follows.

- Day: Tuesday
- Time: 2:00 pm
- Period: Monthly
- Run Time: 5 minutes

Refer to the Exercise Settings section of this manual for more information on setting up the exerciser.

5.4 Engine Oil

Recommended Engine Oil

Check the oil level prior to starting the generator set to verify that the oil level is between the High and Low marks. The generator set is shipped with engine oil.

The use of quality engine oils combined with appropriate oil and filter change intervals are critical factors in maintaining engine performance and durability.

Cummins Inc. recommends the use of a high quality SAE 5W-40 GEO (all ambients) or SAE 15W-40 GEO (above 40 °F [4 °C]) engine oil for natural gas engines. In addition, oil needs to conform with CES 20085. Refer to the Model Specifications section for oil specification details.

NOTICE

Use of improper oils can result in engine damage. Use only the recommended oils.

NOTICE

Use of GEO 15W-40 oil in ambient temperatures below 40 °F (4 °C) could result in engine turbocharger damage.

Checking Engine Oil Level

⚠ WARNING***Automated Machinery***

Accidental or remote starting of the generator set can cause severe personal injury or death.

Isolate all auxiliary supplies and use an insulated wrench to disconnect the starting battery cables, negative (-) cable first.

⚠ WARNING***Hot Surfaces***

Contact with hot surfaces can cause severe burns. Wear appropriate PPE when working on hot equipment and avoid physical contact with hot surfaces.

⚠ WARNING***Toxic Hazard***

State and federal agencies have determined that contact with used engine oil can cause cancer or reproductive toxicity.

Avoid skin contact and breathing of vapors. Use rubber gloves and wash exposed skin.

⚠ WARNING***Toxic Hazard***

Crankcase pressure can blow out hot oil and cause severe burns.

Do NOT check oil while the engine is operating.

NOTICE

Check the engine oil level when the engine is not running and is out of Auto mode.

NOTICE

Overfilling can cause foaming or aeration of the oil, and operation below the low mark may cause loss of oil pressure. Do not operate the engine with the oil level below the low mark or above the high mark.

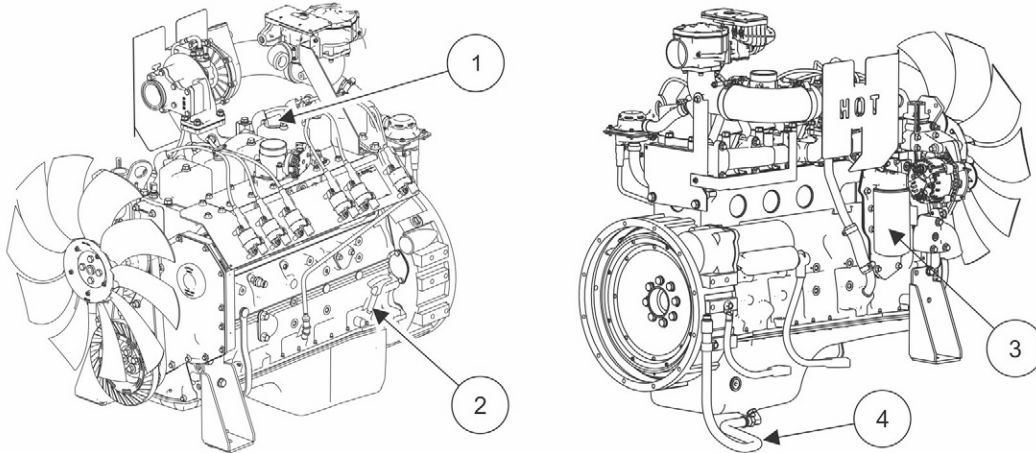

No.	Description	No.	Description
1	Fill Cap	3	Oil Filter
2	Dipstick	4	Oil Drain Hose

FIGURE 38. ENGINE OIL COMPONENTS

1. Make sure the generator set is shut down and disabled:
 - a. Press the Off switch from the display and then press the E-Stop button to stop the generator set. Allow the generator set to thoroughly cool to the touch.
 - b. Turn off and disconnect the battery charger from the AC source before disconnecting the battery cables.
 - c. Disconnect the negative (–) cable from the battery and secure it from contacting the battery terminals to prevent accidental starting.
2. To check the engine oil level:
 - a. Make sure that the engine has not been running for approximately five minutes.
 - b. Clean off the area surrounding the dipstick port to prevent entry of debris into the oil pan.
 - c. Pull out the dipstick and wipe it clean.

- d. Reinsert and fully seat the dipstick.
- e. Remove the dipstick and check the oil level.

NOTICE

The engine oil level indicated on the dipstick should be between the High (15 qt [14.2L]) and Low (13 qt [12.4L]) marks.

- f. Reinsert and fully seat the dipstick.

If the engine oil level check shows excessive or insufficient levels of oil (that is, oil level line above the High mark or below the Low mark), oil must be drained or added. Refer to the following sections for instructions and guidelines for draining and adding oil.

Adding or Draining Oil

⚠ WARNING**Hot Surfaces**

Contact with hot surfaces can cause severe burns. Wear appropriate PPE when working on hot equipment and avoid physical contact with hot surfaces.

⚠ WARNING**Hot Engines**

Contact with hot engines can cause severe burns. Ensure that the generator set engine has cooled down before adding or draining the oil.

NOTICE

Too much oil can cause high oil consumption. Too little oil can cause severe engine damage. Keep the oil level between the High and Low marks on the dipstick.

Adding Oil

If the oil level is found to be insufficient, oil must be added.

1. Ensure that the oil fill cap area is clean, and prevent debris from entering the engine.
2. Add the appropriate amount of oil, based on the engine oil level check. Refer to the Checking Engine Oil Level section and the Model Specifications section.
3. Recheck the engine oil level. Based on the results, add or drain oil.
4. Clean up and dispose of any oil in accordance with local/state regulations.

Draining Oil

If the oil level is found to be excessive, oil must be drained from the engine.

1. Detach the oil drain hose from the side of the engine.
2. Place the end of the drain hose into an appropriate container.

Refer to local regulations to determine the appropriate container for used oil.

- Open the oil drain valve to release oil from the engine into the appropriate container.
- Recheck the engine oil level. Based on the results, add or drain oil.
- When a sufficient amount of oil has been drained from the system:
 1. Close the oil drain valve.
 2. Wipe the oil drain valve clean.
 3. Re-attach the drain hose to the side of the engine.
 4. Dispose of the used oil in accordance with local/state regulations.

Changing Engine Oil and Oil Filter

WARNING

Automated Machinery

Accidental or remote starting of the generator set can cause severe personal injury or death.

Isolate all auxiliary supplies and use an insulated wrench to disconnect the starting battery cables, negative (-) cable first.

WARNING

Toxic Hazard

State and federal agencies have determined that contact with used engine oil can cause cancer or reproductive toxicity.

Avoid skin contact and breathing of vapors. Use rubber gloves and wash exposed skin.

NOTICE

If the oil and/or oil filter are not reused, dispose of them in accordance with local environmental regulations.

NOTICE

Change the engine oil and filter when the engine is not running and is out of Auto mode.

NOTICE

Change the oil more often in hot and dusty environments.

NOTICE

Cummins highly recommends that any service or maintenance work be performed by qualified technicians.

1. Before changing the oil, the generator set should be operated until the water temperature is approximately 60 °C (140 °F).
2. Make sure the generator set is shut down and disabled:
 - a. Press the generator set's "O" (Off) button to stop the generator set. Allow the generator set to thoroughly cool to the touch.
 - b. If applicable, turn off and disconnect the battery charger from the AC source before disconnecting the battery cables.
 - c. Disconnect the negative (–) cable from the battery and secure it from contacting the battery terminals to prevent accidental starting.
3. Drain the oil. Place the end of the drain hose into an appropriate container.

NOTICE

Refer to local regulations to determine the appropriate container for used oil.

4. Remove the oil filter, and clean the filter mounting surface on the engine block. Remove the old gasket if it remains.
5. Make sure the gasket is in place on the new filter and apply a thin film of clean oil to the gasket.
6. Install the new filter until the gasket just touches the block. Turn it an additional 1/2 to 3/4 turn. Do not over-tighten.
7. Remove the container used to collect oil when removing the oil filter.
8. Close the oil drain valve.
9. Add the appropriate amount of oil.

NOTICE

Too much oil can cause high oil consumption. Too little oil can cause severe engine damage. Keep the oil level between the High and Low marks.

10. Operate the engine at idle to inspect for leaks at the lubricating oil filter and the drain plug.
11. Confirm that the correct oil level is in the pan:
 - a. Shut the generator set off and wait 5 minutes.
 - b. Check the engine oil level.
12. Check and repair any leaks identified.

13. Dispose of the used oil and oil filter according to local environmental regulations.

5.5 Air Intake System

The direct flow air cleaner consists of a primary filter and a secondary filter within the air cleaner housing. The air cleaner has been designed for a maximum restriction at 25 in water column (6.2 kPa), at which point the filter elements should be changed.

Normal Duty Air Cleaner Element Replacement

NOTICE

Holes, loose-end seals, dented sealing surfaces, corrosion of pipes, and other forms of damage render the air cleaner inoperative and require immediate element replacement or engine damage can occur.

NOTICE

Cummins Inc. does not recommend cleaning paper-type air cleaner elements.

1. Remove the existing air cleaner:
 - a. Loosen the strap clamp (2).
 - b. Wipe away any debris accumulated around the air cleaner connection to the engine. Ensure that no debris is allowed to enter the body of the air cleaner or the connection on the engine.
 - c. Remove the dirty air cleaner (1).
 - d. Dispose of the dirty element in accordance with local environmental agency requirements.
2. Install the replacement air cleaner (1) as follows:
 - a. Install the air cleaner (1).
 - b. Tighten strap clamp (2). Torque to 2.5 - 3.3 ft-lb (4.3 - 4.65 Nm).

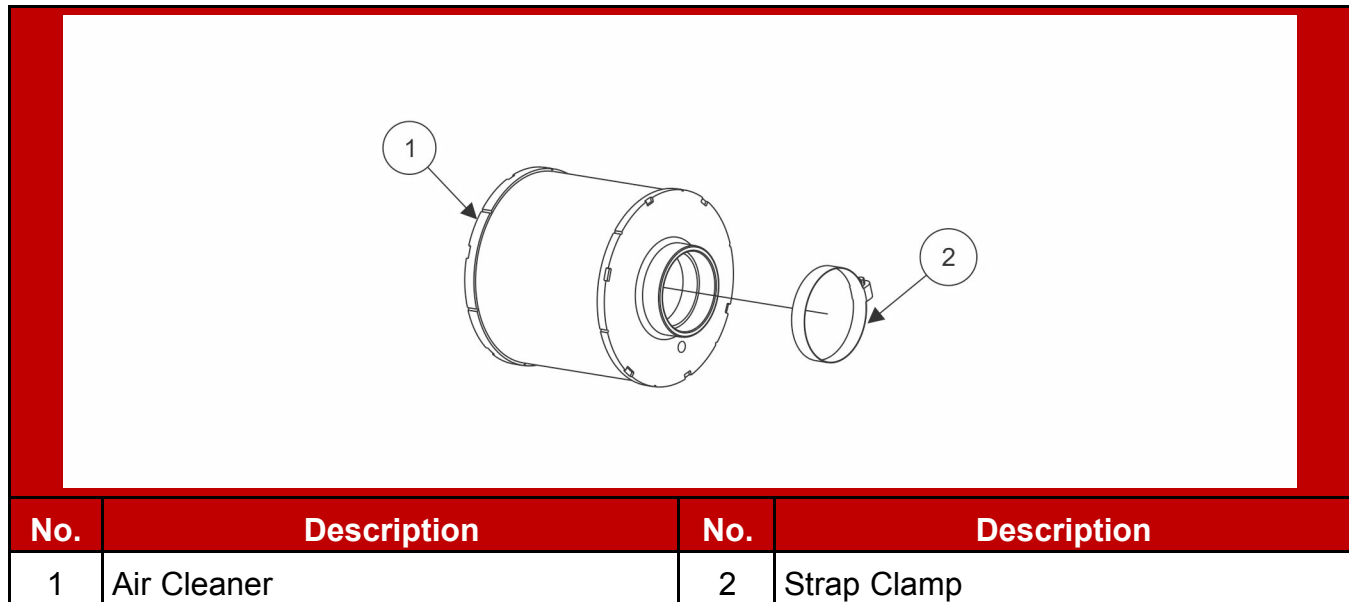

FIGURE 39. EXAMPLE OF NORMAL DUTY AIR CLEANER

Heavy Duty Air Cleaner Element Replacement

⚠ CAUTION

Holes, loose-end seals, dented sealing surfaces, corrosion of pipes, and other forms of damage render the air cleaner inoperative and require immediate element replacement or engine damage can occur.

NOTICE

Cummins Inc. does not recommend cleaning paper-type air cleaner elements.

1. To remove the existing air cleaner element:
 - a. Before disassembly, wipe dirt from the cover and the upper portion of the air cleaner.
 - b. Lift the latch (3) and turn the end cover (4) counterclockwise.
 - c. Pull the end cover (4) away from the housing (1).
 - d. Remove the air filter element (2) from the housing (1).
 - e. Dispose of the dirty element in accordance with local environmental agency requirements.
2. To install the replacement air cleaner element:
 - a. Ensure that no debris enters the filter element or connection point on the air cleaner housing.
 - b. Insert the air filter element (2) into the housing (1).
 - c. Install the end cover (4) onto the housing (1).

d. Turn the end cover (4) clockwise until the latch (3) snaps into place.

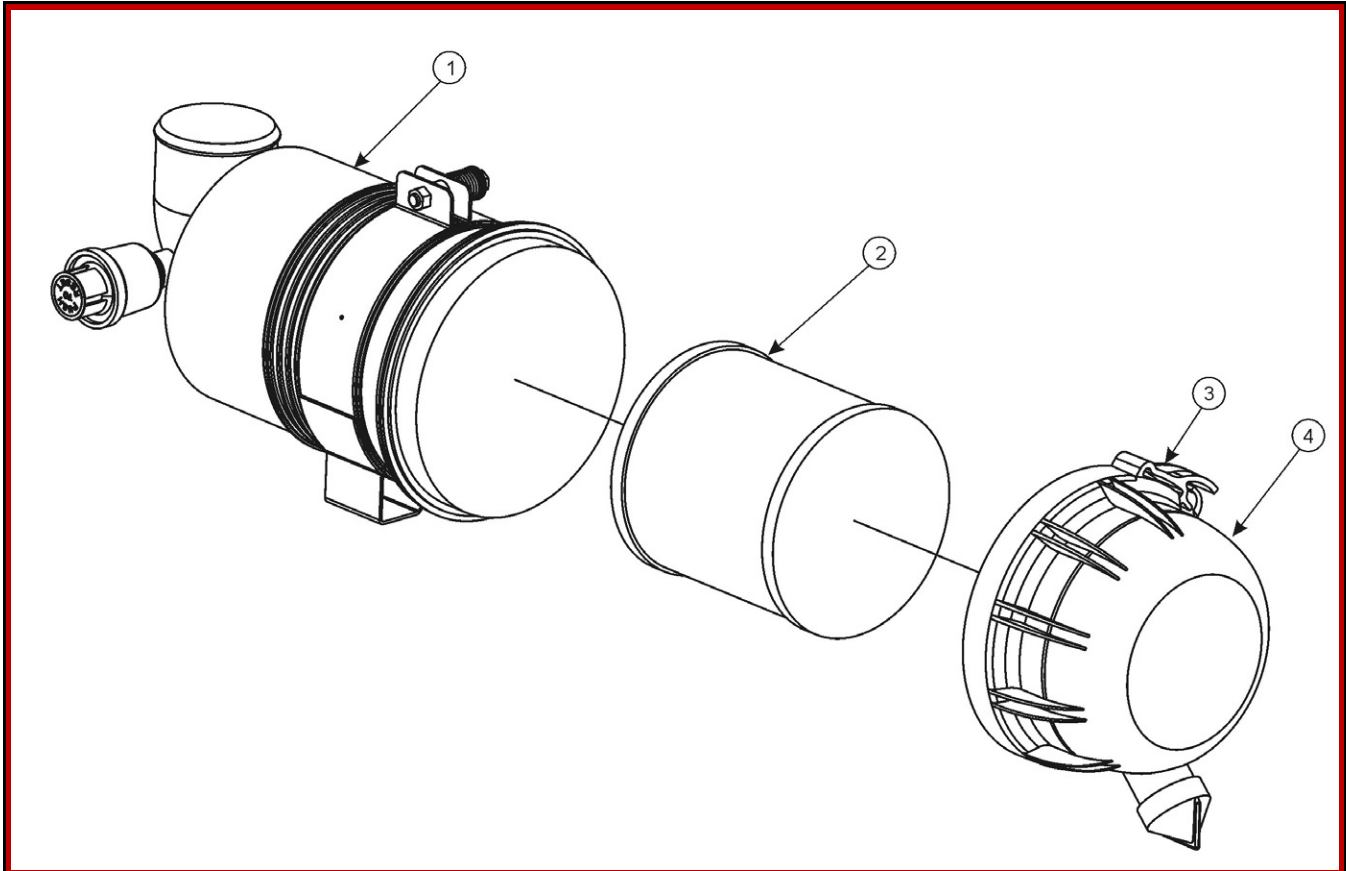

No.	Description	No.	Description
1	Housing	3	Latch
2	Air Filter Element	4	End Cover

FIGURE 40. EXAMPLE OF HEAVY DUTY AIR CLEANER

5.6 Batteries

Batteries are an essential part of any standby generator set system. A significant amount of generator set failures are due to battery issues.

It is therefore vital that batteries are stored, commissioned, and maintained as detailed here. Reference should also be made to the battery manufacturer’s instructions.

Maintenance free batteries (if supplied with the generator set) need no maintenance for commissioning.

Storage

Batteries must be stored in a cool, dry, well-ventilated place, in the upright position, and with the vent caps securely in place.

Batteries must never be stacked on top of each other and must be protected from the floor by a wooden pallet or suitably thick cardboard sheet.

Safety Precautions

Servicing of batteries are to be performed or supervised by personnel knowledgeable of batteries and the required precautions. Keep unauthorized personnel away from batteries.

General Precautions for Maintenance-Free Batteries

Handling and proper use of batteries is not hazardous if the correct precautions are observed and personnel are trained in their use.

WARNING

Arcing Hazard

Laying tools or metal objects across the battery can cause arcing that may ignite battery gases causing explosions resulting in personal injury.

Never lay tools or metal objects across the top of the battery.

WARNING

Electric Shock Hazard

Voltages and currents present an electrical shock hazard that can cause severe burns or death.

Use tools with insulated handles to prevent the risk of electric shock.

CAUTION

Toxic Hazard

Electrolyte is a dilute sulphuric acid that is harmful to the skin and eyes. It is electrically conductive and corrosive.

Wear full eye protection and protective clothing. If electrolyte contacts the skins, wash it off immediately with water. If electrolyte contacts the eyes, flush thoroughly and immediately with water and seek medical attention. Wash spilled electrolyte with an acid neutralizing agent.

NOTICE

Keep batteries upright to prevent spillage.

Fire Hazard

WARNING

Combustible Gases

Lead acid batteries present a risk of fire because they generate hydrogen gas.

Do not smoke near the batteries. Do not cause flame or spark in the battery area. Discharge static electricity from your body before touching batteries by first touching a grounded metal surface.

WARNING

Before disconnecting a battery, always remove power from the AC powered battery charger.

WARNING

When putting a battery into service on a generator set, connect the negative lead LAST; when removing the battery, disconnect the negative lead FIRST.

Vented Batteries

WARNING

Toxic Hazard

The electrolyte in vented batteries is a dilute sulfuric acid that is harmful to the skin and eyes. It is also electrically conductive and corrosive.

Always:

- 1. Wear full eye protection and protective clothing;**
- 2. If the electrolyte contacts the skin, wash it off immediately with water;**
- 3. If the electrolyte contacts the eyes, flush them thoroughly and immediately with water and seek medical attention; and**
- 4. Wash spilled electrolyte down with an acid neutralizing agent. A common practice is to use a solution of one pound (500 grams) bicarbonate of soda (also known as baking soda or sodium bicarbonate) to one gallon (4 liters) of water.**
- 5. Continue to add the bicarbonate of soda solution until the evidence of reaction (that is, foaming) has stopped.**
- 6. Flush the resulting liquid with water and dry the area.**

Battery Maintenance

WARNING

Automated Machinery

Accidental or remote starting of the generator set can cause severe personal injury or death. Arcing at battery terminals or in light switches or other equipment, and flames or sparks can ignite battery gas causing severe personal injury.

Always follow these procedures to avoid injury and/or damage:

- ***Ventilate the battery area before working on or near the battery.***
- ***Wear safety glasses.***
- ***Do not smoke.***
- ***Switch a work light on or off away from the battery.***

Make sure the generator set is shut down and disabled:

1. ***Press the generator set's red STOP button on the local display to stop the generator set. Allow the generator set to thoroughly cool to the touch.***
2. ***Turn off and disconnect the battery charger from the AC source before disconnecting the battery cables.***
3. ***Disconnect the negative (-) cable from the battery and secure it from contacting the battery terminals to prevent accidental starting.***
4. ***Once work is complete, reconnect the negative (-) battery cable last.***

Replace the battery charger if the battery keeps running down.

Always:

- Keep the battery case and terminals clean and dry and the terminals tight.
- Remove battery cables with an insulated wrench or battery terminal puller.
- Make sure which terminal is positive (+) and which is negative (-) before making battery connections, always removing the negative (-) cable first and reconnecting it last to reduce arcing.

NOTICE

If the battery needs to be replaced, make sure that the replacement battery specifications match those found in the Model Specifications in this manual.

Battery Replacement

⚠ WARNING

Combustible Liquid

Burning the battery may cause an explosion. Damage to the casing will release electrolytes which is harmful to the skin and eyes.

When disposing of a battery, do not mutilate or burn it. Comply with all local health and safety regulations/codes during handling or disposal.

Always replace the starting battery with the same number and type (e.g., vented, lead acid, maintenance free) as listed in the specifications section of this document. Properly dispose of battery in accordance with local environment agency requirements.

Always use correct handling techniques to lift and move a battery.

5.7 Spark Plugs

NOTICE

Make sure service personnel are qualified to perform electrical and mechanical service.

The generator set has six spark plugs, all accessible from the top of the engine. The spark plugs must be in good condition for proper engine starting and performance. A spark plug that fouls frequently or has heavy soot deposits indicates the need for engine service.

1. Set the generator set control to the Off position before checking the spark plugs.
2. To prevent cross-threading a spark plug, always thread it in by hand until it seats. Torque the spark plug to 38 Nm (28 lb-ft).
3. Return the generator set control to the desired setting when finished performing maintenance.

This page is intentionally blank.

6 Troubleshooting

6.1 Avoiding Generator Set Shutdowns

By regularly performing the following periodic maintenance and guidelines, you will greatly reduce the chances of a generator set shutdown:

- Maintain an appropriate oil level.
- Keep battery connections clean and tight.
- Do not overload the generator set.
- Keep the air inlet and outlet openings clear.

Refer to the Maintenance section for more information.

6.2 Fault Code Introduction

Fault code information, together with warning and shutdown information, is provided in this section to assist in locating and identifying the possible causes of faults in the generator set system.

Refer also to the engine-specific operator manual, if it exists. The engine operator manual contains additional information regarding the running and care of the generator set as well as specific equipment instructions that may differ from the standard generator set.

For any fault codes that occur but are not listed, contact your Cummins service representative.

6.3 Engine Is Difficult to Start or Does Not Start

Possible Causes:

1. Battery voltage problem(s)
2. Fuel system issue(s)
3. Air intake restriction above specification

Diagnosis and Repair:

1. Battery voltage problem(s)
 - a. If battery voltage is low, interrupted, or open, check:
 - Battery connections
 - Unswitched battery supply circuit
 - Fuses
2. Fuel system issue(s)
 - a. Verify that the manual fuel shutoff valve is open.

3. Air intake restriction above specification
 - a. Inspect air filter for obstruction. Replace if necessary.

6.4 Code 143 - Engine Oil Pressure Low (Warning)

Logic: Engine oil pressure is below the low oil pressure warning threshold.

Possible Causes:

1. Lubricating oil level is low
2. External leak

Diagnosis and Repair:

1. Lubricating oil level is low
 - a. Check the oil level. Add oil, if necessary.
2. External leak
 - a. Inspect the engine and surrounding area for external oil leaks.
 - b. If a leak is present, contact your Cummins service representative.

6.5 Codes 146 and 151 - Engine Coolant Temperature High (Warning or Shutdown)

Logic:

- *Code 146:* Engine coolant temperature has exceeded the warning threshold and duration parameters set in the ECM or control.
- *Code 151:* Engine coolant temperature has exceeded the shutdown (alarm) threshold for high coolant temperature.

Possible Causes:

1. High ambient temperature
2. Enclosure air intake blocked
3. Coolant level below specification
4. Blocked radiator
5. Blocked enclosure air discharge
6. Broken or loose fan belt

Diagnosis and Repair:

1. High ambient temperature
 - a. Reduce loads or recirculation of discharge air to generator set.
2. Blocked enclosure air discharge
 - a. Inspect for dirt, debris, or obstructions.
 - b. Remove blockage or snow/ice buildup if applicable.

3. Coolant level below specification
 - a. Check coolant level.
 - b. Add coolant if applicable.
4. Blocked radiator
 - a. Inspect for dirt, debris, or obstruction.
 - b. Remove blockage or winterfront if applicable.
5. Enclosure air discharge blocked
 - a. Inspect for dirt, debris, or obstructions.
 - b. Remove blockage or snow/ice buildup if applicable.
6. Broken or loose fan belt
 - a. Inspect belt(s) for damage, wear, and proper tension.
 - b. Repair or replace belt(s) if damaged or worn.

6.6 Code 155 - Intake Manifold Temperature High (Shutdown)

Logic: The engine intake manifold temperature has exceeded the temperatures below for greater than 10 seconds:

- Models C45 N6, C50 N6 and C60 N6: 75 °C (167 °F)
- Models C70 N6, C80 N6 and C100 N6: 80 °C (176 °F)

Diagnosis and Repair:

For the troubleshooting procedure, refer to DTC 127 in the E-Controls Manual, which applies to several applications. See the drawings provided with the generator set or the wiring diagrams appendix for the appropriate pin numbers.

6.7 Code 197 - Coolant Level Low (Warning)

Logic: Coolant level sensor signal is showing a low coolant level for greater 10 seconds.

Possible Cause:

1. Low coolant

Diagnosis and Repair:

1. Low coolant
 - a. Remove radiator cap and check that coolant is up to the required level.

6.8 Code 415 - Engine Oil Pressure Low (Shutdown)

Logic:

Engine oil pressure is below 26 psig (180 kpa) for greater than 10 seconds.

Possible Cause:

1. Lubricating oil level is low
2. External leak

Diagnosis and Repair:

1. Lubricating oil level is low
 - a. Check the oil level. Add oil, if necessary.
2. External leak
 - a. Inspect the engine and surrounding area for external oil leaks.
 - b. Contact your local dealer if a leak is present.

6.9 Code 441 - Battery Voltage Low (Warning)

Logic: Battery voltage is low.

Possible Causes:

1. Loose or damaged battery cable connections
2. Battery charger not connected (if equipped)
3. Battery not completely charged
4. Battery is old and does not maintain a charge

Diagnosis and Repair:

1. Loose or damaged battery cable connections
 - Inspect the battery cable connections for corrosion and loose connections. Adjust or repair if needed.
2. Battery charger not connected (if equipped)
 - a. Make sure that the battery charger is connected to the AC power supply.
 - b. Make sure that the battery charger is connected correctly to the battery.
3. Battery not completely charged
 - Using a voltmeter or multimeter, determine if the voltage is below 11 V. If so, recharge the battery.
4. Battery is old and does not maintain a charge
 - Replace the battery.

6.10 Code 488 - Intake Manifold Temperature High (Warning)

Logic:

The engine intake manifold temperature has exceeded the temperatures below for more than 90 seconds:

- Models C45 N6, C50 N6 and C60 N6: 158 °F (70 °C)
- Models C70 N6, C80 N6 and C100 N6: 167 °F (75 °C)

Possible Causes:

1. High ambient temperature
2. Enclosure air intake blocked
3. Coolant level is below specification
4. Radiator blocked
5. Enclosure air discharge blocked
6. Fan belt is broken or loose

Diagnosis and Repair:

1. High ambient temperature
 - a. Reduce loads or recirculation of discharge air to generator in elevated ambient.
2. Enclosure air intake blocked
 - a. Inspect for dirt, debris, or obstructions.
 - b. Remove blockage or snow/ice buildup as applicable.
3. Coolant level is below specification
 - a. Check coolant level.
 - b. Add coolant as necessary.
4. Radiator blocked
 - a. Inspect for dirt, debris or obstructions.
 - b. Remove blockage or winterfront as applicable.
5. Enclosure air discharge blocked
 - a. Inspect for dirt, debris, or obstructions.
 - b. Remove blockage or snow/ice buildup as applicable.
6. Fan belt is broken or loose
 - a. Inspect belt(s) for damage, wear, and proper tension.
 - b. Repair or replace if damaged or worn.

6.11 Code 1438 - Fail to Crank (Shutdown)

Logic:

The engine failed to crank after the generator control received a start signal.

Possible Cause:

1. Dead or weak battery
2. Failed starter

Diagnosis and Repair:

1. Dead or weak battery
 - a. Verify battery voltage is at least 12 VDC (or 24 VDC if applicable).
 - b. Charge or replace the battery as necessary.
2. Failed starter
 - a. Press the Reset/Fault acknowledge button on the display.
 - b. Attempt to start the generator and test for B+ at the starter supply lug.
 - c. If B+ is present at the starter supply lug, the starter could be defective.

6.12 Code 1472 - High AC Current (Shutdown)

Logic:

The generator output current has exceeded at least 150% of rated current.

Possible Causes:

1. Generator set overload

Diagnosis and Repair:

1. Generator set overload.
 - a. Reduce the generator set load by powering off to unnecessary household appliances (examples: washer, dryer, air conditioning, etc.).

6.13 Code 5134 - Unknown Shutdown at Idle

Logic:

Engine is not getting a proper fuel supply.

Possible Causes:

1. Fuel supply issue

Diagnosis and Repair:

1. Fuel supply issue
 - a. Check that there is a proper supply of fuel to the engine.

power.cummins.com

Copyright © 2017 Cummins Inc. All rights reserved.

Cummins, the "C" logo, PowerCommand, AmpSentry, and InPower are trademarks of Cummins Inc.

Other company, product, or service names may be trademarks or service marks of others.

Specifications are subject to change without notice.

