

LP-40.3

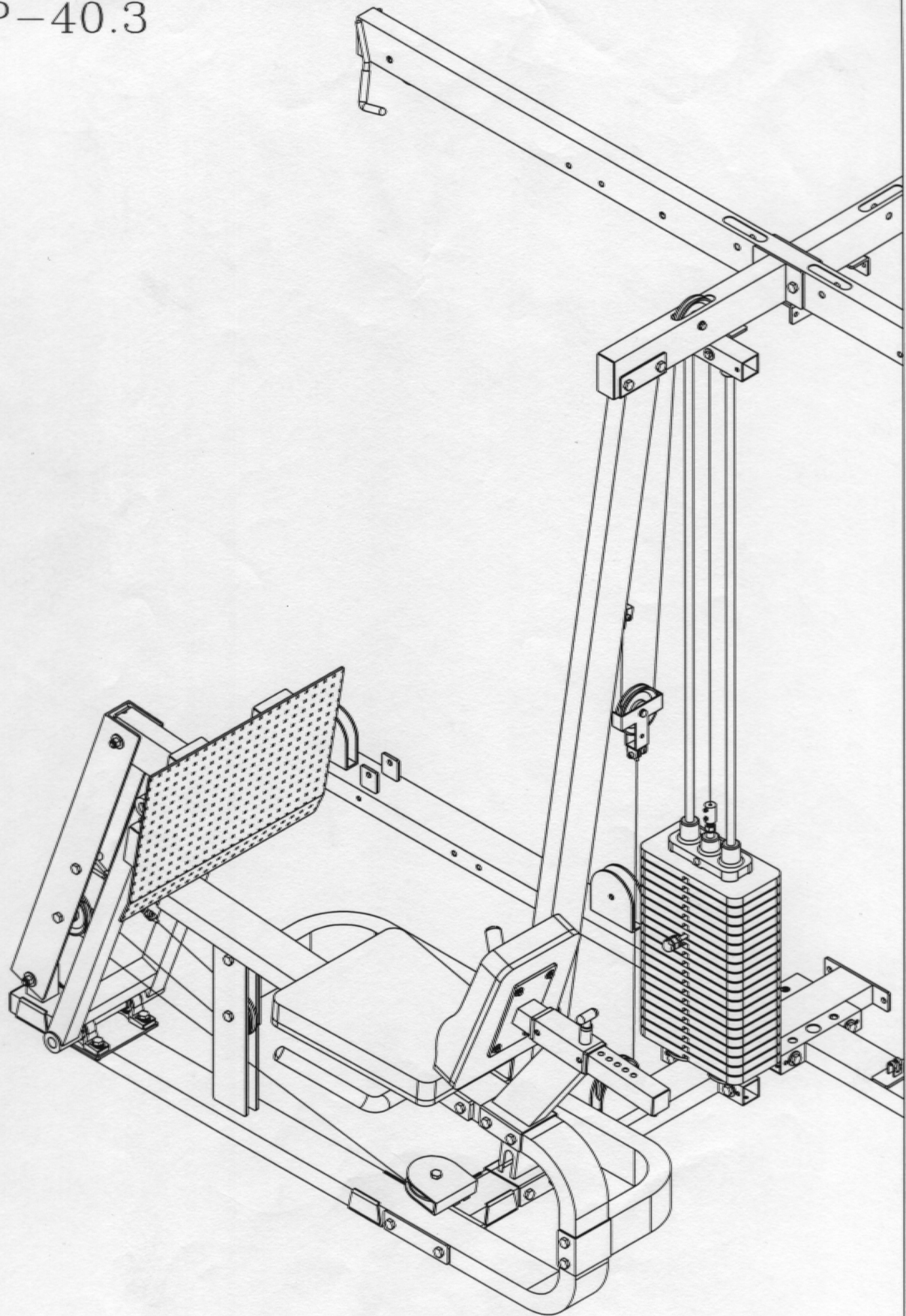

VERSION 0903

LP-40.3 HARDWARE ILLUSTRATION SHEET

	Qty.		Qty.
A1. 1/2"X5 3/4" HEX HEAD BOLT -----	[2PCS]	C3. 5/16" SPRING WASHER-----	[7PCS]
A2. 1/2"X5 1/4" HEX HEAD BOLT -----	[3PCS]	C5. 1/2"Xø25 (I.D)WASHER-----	[4PCS]
A3. 1/2"X5" HEX HEAD BOLT -----	[8PCS]	C6. 1/2" SPRING WASHER-----	[1PCS]
A4. 1/2"X3 3/4" HEX HEAD BOLT -----	[2PCS]		
A5. 1/2"X3 1/4" HEX HEAD BOLT -----	[1PCS]		
A6. 1/2"X3" HEX HEAD BOLT -----	[4PCS]		
A7. 1/2"X2 1/2" HEX HEAD BOLT -----	[2PCS]		
A8. 1/2"X2" HEX HEAD BOLT -----	[2PCS]		
A9. 1/2"X1 3/4" HEX HEAD BOLT -----	[4PCS]		
A10. 3/8"X2 3/4" HEX HEAD BOLT -----	[1PCS]		
A11. 5/16"X3" HEX HEAD BOLT -----	[1PCS]		
A12. 5/16"X1" HEX HEAD BOLT -----	[6PCS]		
A14. 5/16"X3/8" SET SCREW -----	[3PCS]		
A16. 15LB PIN -----	[1PCS]		
A17. ø5/8"X116L SHAFT BOLT -----	[2PCS]		
A18. 5/16"X1 1/2" ROUND BOLT -----	[2PCS]		
A19. ø1/2"X22L SLEEVE -----	[2PCS]		
A20. 1/2" ROUND BOLT(8260-009)-----	[1PCS]		
A21. 3/8"X2" ROUND BOLT -----	[1PCS]		
B1. 1/2" NYLON LOCK NUT -----	[30PCS]		
B2. 3/8" NYLON LOCK NUT -----	[1PCS]		
B4. 5/16" NYLON LOCK NUT -----	[2PCS]		
B5. 1/2" LOCK NUT -----	[1PCS]		
C1. 1/2"Xø34 (I.D)WASHER -----	[8PCS]		
C2. 5/16" (I.D)WASHER -----	[7PCS]		

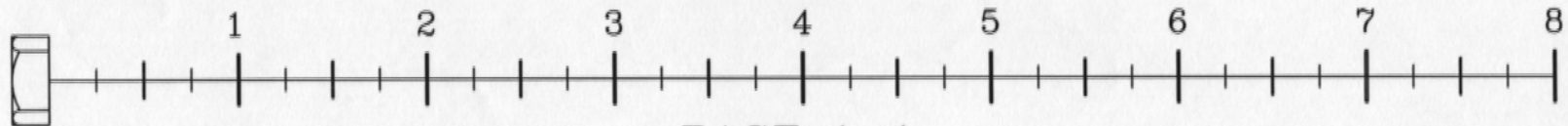
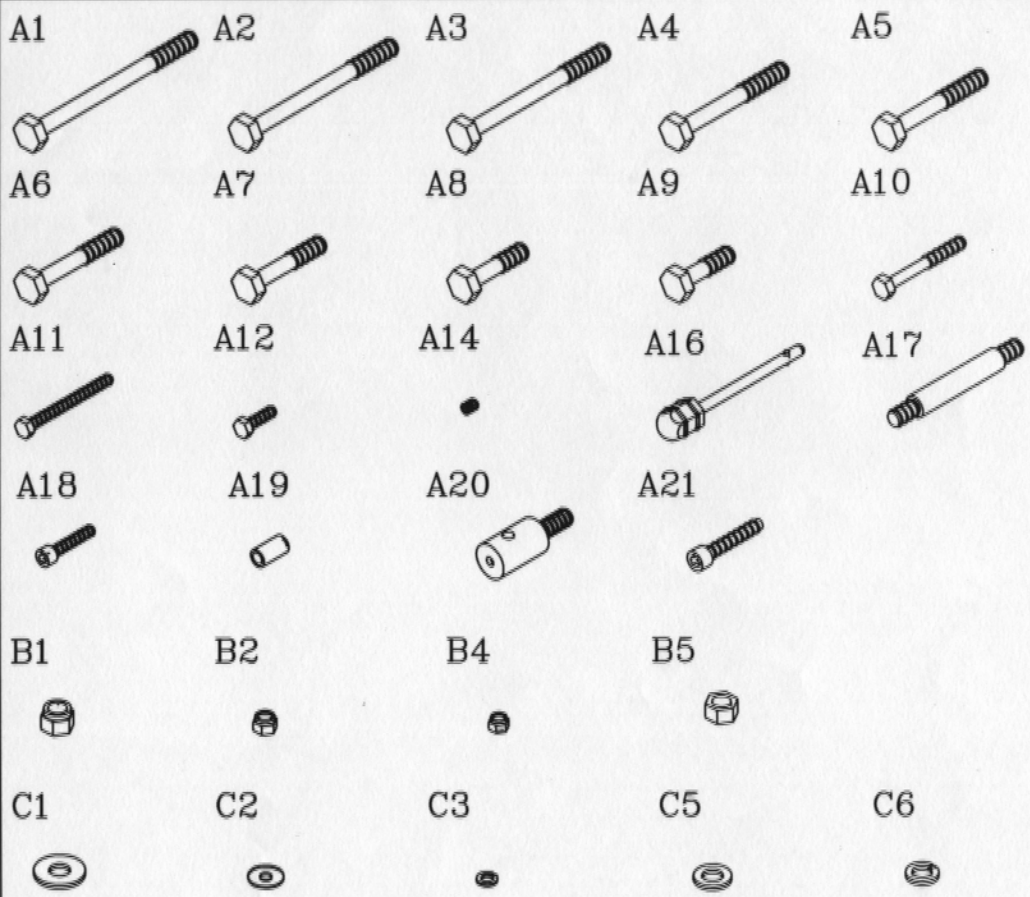

GLP40

HARDWARE ILLUSTRATION SHEET

	Qty.
D1. 2"X4" RUBBER DOUNT (9212-009)-----	[4PCS]
D2. 2"X4" END CAP (9211-014)-----	[6PCS]
D3. 2"X2"X1.8t END CAP (9211-005)-----	[1PCS]
D4. 2"X2"X2.5t END CAP (9211-006)-----	[1PCS]
D5. $\phi 3/4$ " PULLEY SPACER (8110-017)-----	[4PCS]
D6. $\phi 4$ " RUBBER DONUT (9310-017)-----	[2PCS]
D7. $\phi 4 1/2$ "X $\phi 3/8$ " PULLEY (9213-010C)-----	[1PCS]
D8. $\phi 4 1/2$ "X $\phi 1/2$ " PULLEY (9213-010B)-----	[4PCS]
D9. 60X50 NYLON BUSHING (9211-033)-----	[2PCS]
D13. $\phi 8$ SPRING SNAP LINK (8810-001)-----	[1PCS]
D14. $\phi 16$ X15 STEEL BUSHING (8530-003)-----	[2PCS]
D17. 2650mm STEEL CABLE -----	[1PCS]
D18. 3880mm STEEL CABLE -----	[1PCS]
D19. $\phi 3/4$ "X8L STEEL BUSHING (8110-014)-----	[4PCS]
D20. $\phi 3/4$ " SHAFT COLLAR (9211-046)-----	[2PCS]
D21. TOP PLATE (8400-005)-----	[1PCS]
D22. WEIGHT SELECTOR BAR (8210-042)-----	[1PCS]
D23. $\phi 1$ " ROUND END CAP (9260-021)-----	[2PCS]
D24. $\phi 5/8$ " ROUND END CAP (9211-015)-----	[2PCS]

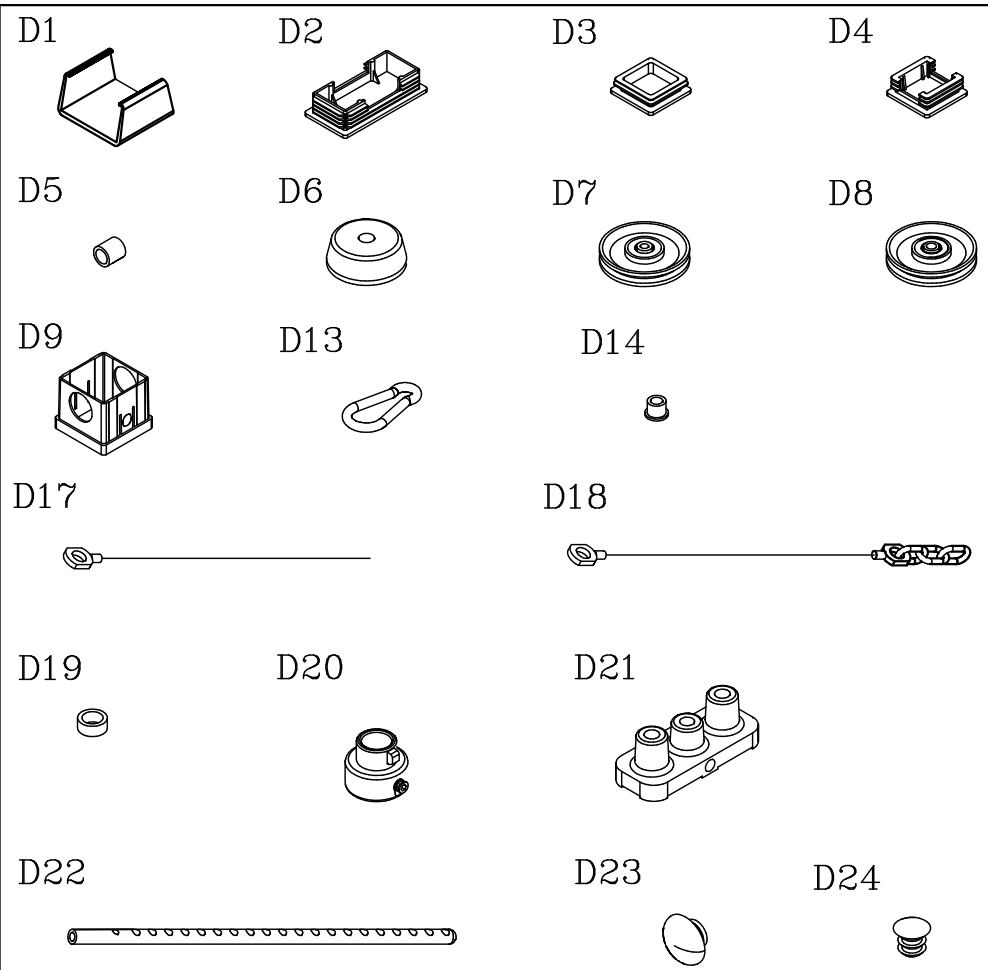

LP-40.3 PARTS ILLUSTRATION SHEET

A [1PCS]

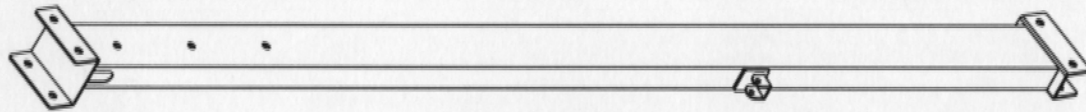

F [1PCS]

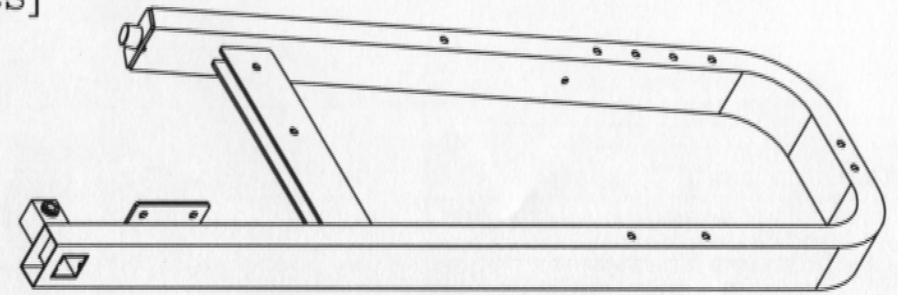

B [1PCS]

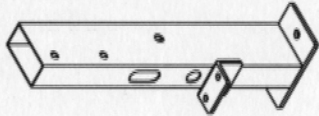

E [1PCS]

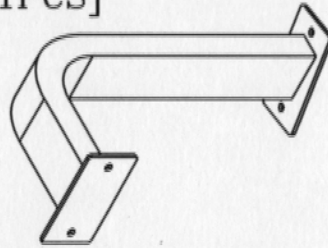

C [1PCS]

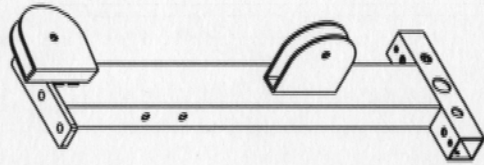

G [1PCS]

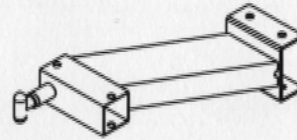

I [1PCS]



L [1PCS]

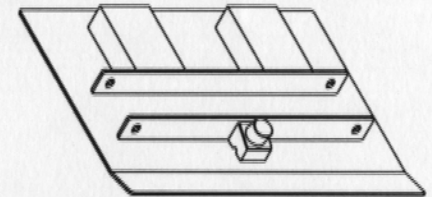

D [1PCS]

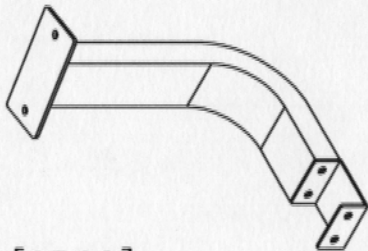

H [1PCS]

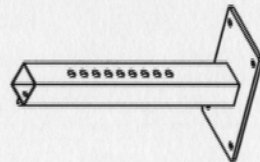

J [1PCS]

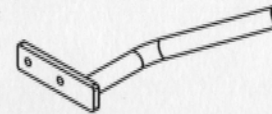

M [1PCS]

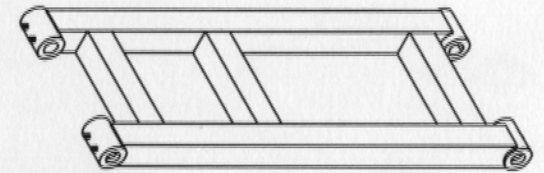

O [2PCS]

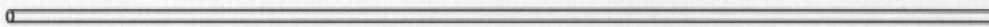

K [1PCS]

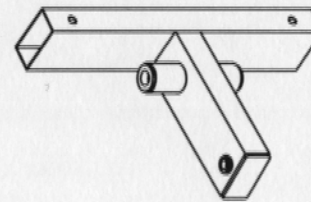

N [1PCS]

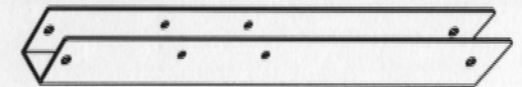

P [1PCS]

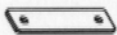

Q [2PCS]



R [1PCS]



S [1PCS]

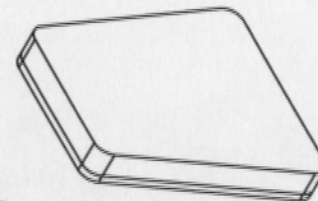

T [1PCS]

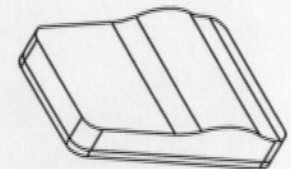

GLP40

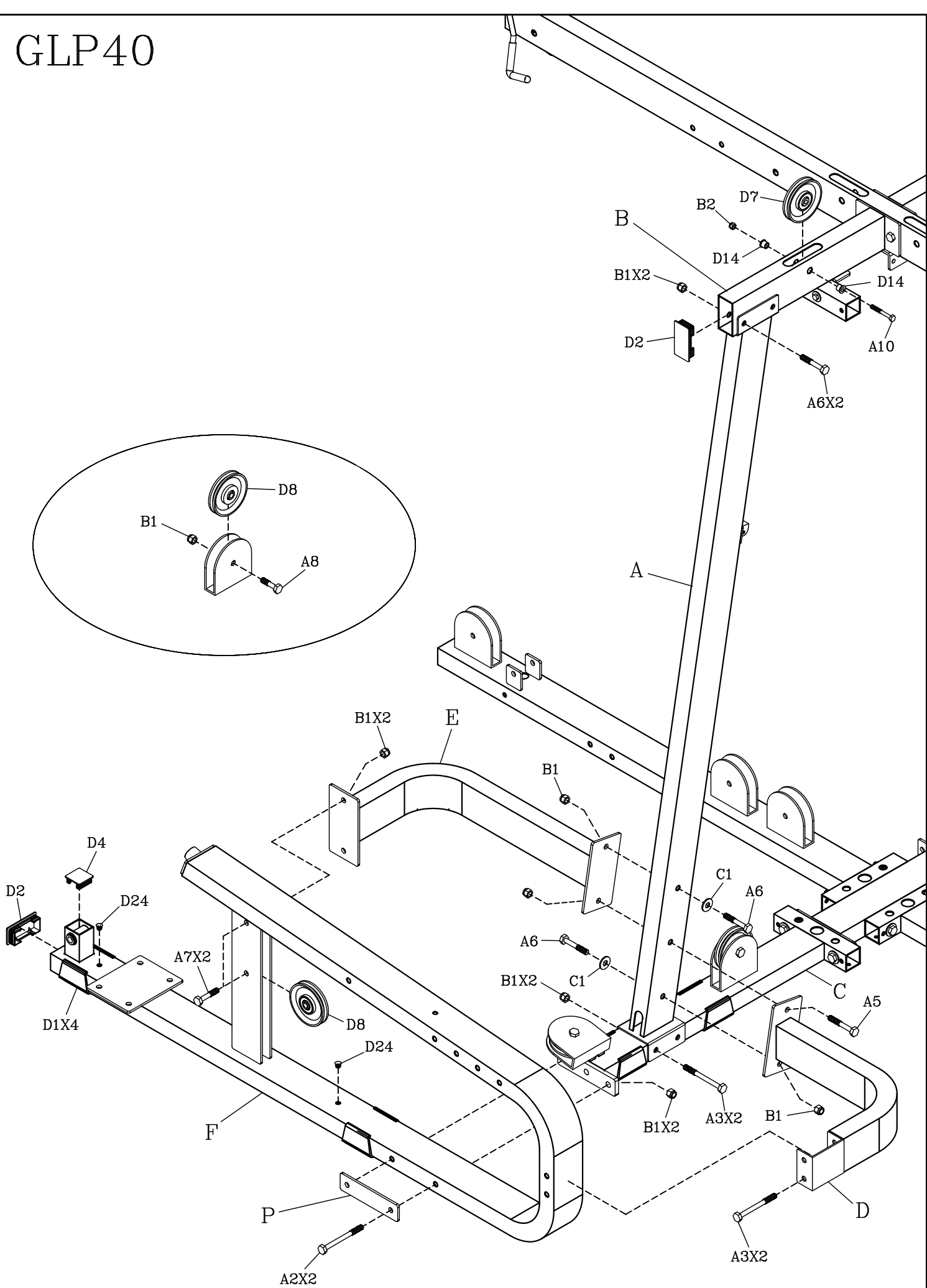

LP-40.3

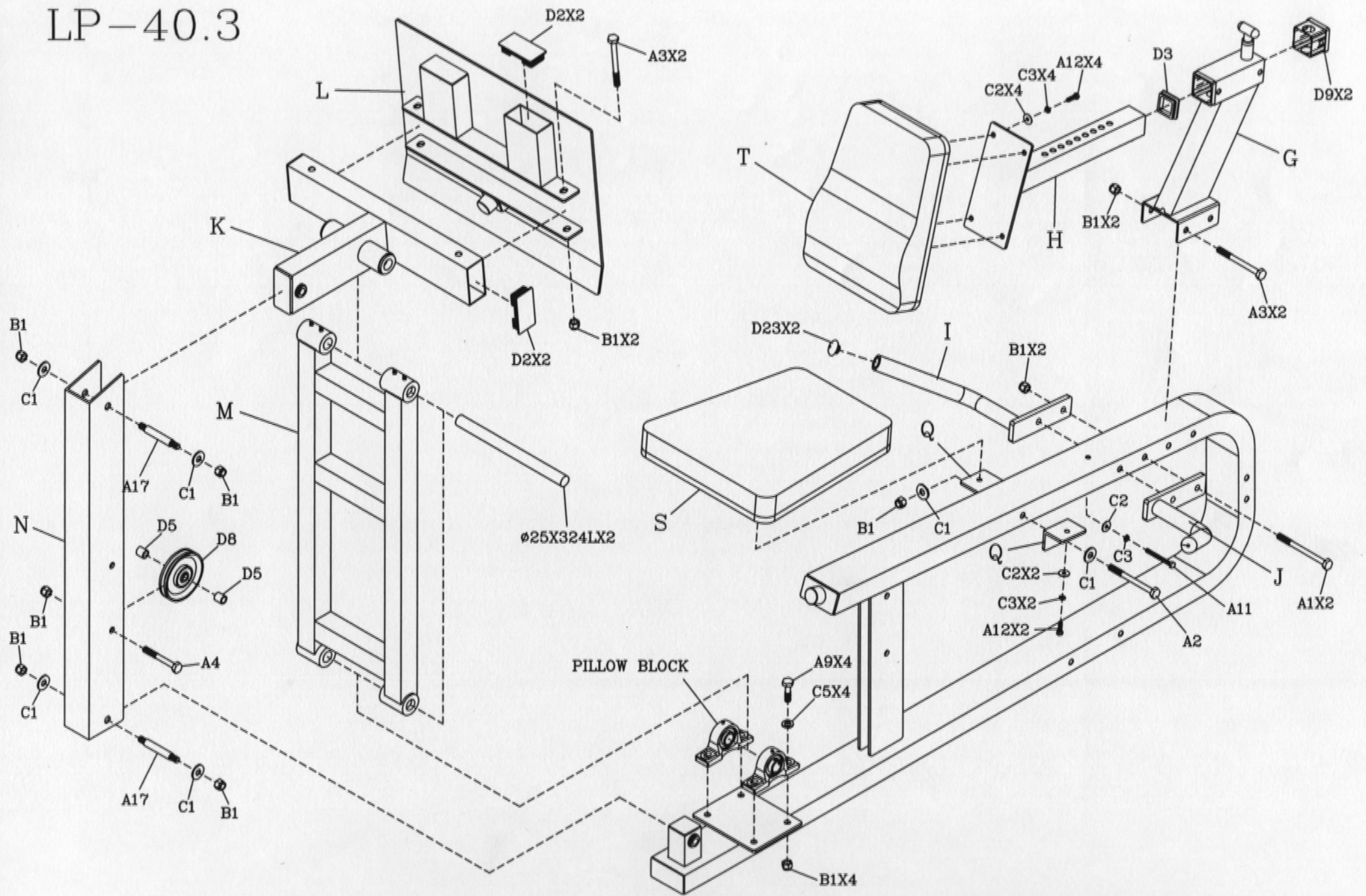

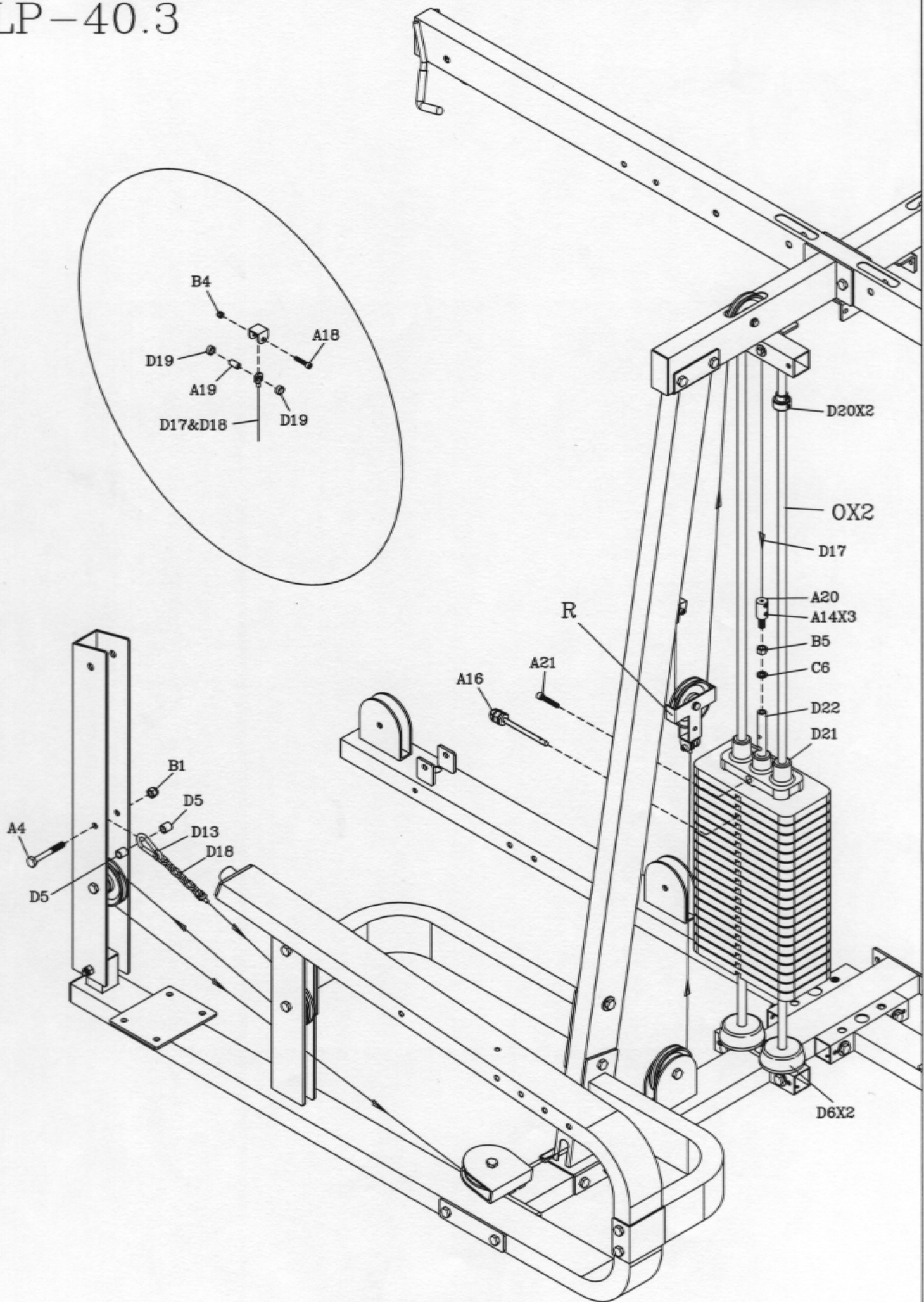

LP-40.3 HARDWARE ILLUSTRATION SHEET

	Qty.	
A1. 1/2"X5 3/4" HEX HEAD BOLT -----	[2PCS]	C3. 5/16" SPRING WASHER-----
A2. 1/2"X5 1/4" HEX HEAD BOLT -----	[3PCS]	C5. 1/2"Xø25 (I.D)WASHER-----
A3. 1/2"X5" HEX HEAD BOLT -----	[8PCS]	C6. 1/2" SPRING WASHER-----
A4. 1/2"X3 3/4" HEX HEAD BOLT -----	[2PCS]	
A5. 1/2"X3 1/4" HEX HEAD BOLT -----	[1PCS]	
A6. 1/2"X3" HEX HEAD BOLT -----	[4PCS]	
A7. 1/2"X2 1/2" HEX HEAD BOLT -----	[2PCS]	
A8. 1/2"X2" HEX HEAD BOLT -----	[2PCS]	
A9. 1/2"X1 3/4" HEX HEAD BOLT -----	[4PCS]	
A10. 3/8"X2 3/4" HEX HEAD BOLT -----	[1PCS]	
A11. 5/16"X3" HEX HEAD BOLT -----	[1PCS]	
A12. 5/16"X1" HEX HEAD BOLT -----	[6PCS]	
A14. 5/16"X3/8" SET SCREW -----	[3PCS]	
A16. 15LB PIN -----	[1PCS]	
A17. ø5/8"X116L SHAFT BOLT -----	[2PCS]	
A18. 5/16"X1 1/2" ROUND BOLT -----	[2PCS]	
A19. ø1/2"X22L SLEEVE -----	[2PCS]	
A20. 1/2" ROUND BOLT(8260-009)-----	[1PCS]	
A21. 3/8"X2" ROUND BOLT -----	[1PCS]	
B1. 1/2" NYLON LOCK NUT -----	[30PCS]	
B2. 3/8" NYLON LOCK NUT -----	[1PCS]	
B4. 5/16" NYLON LOCK NUT -----	[2PCS]	
B5. 1/2" LOCK NUT -----	[1PCS]	
C1. 1/2"Xø34 (I.D)WASHER -----	[8PCS]	
C2. 5/16" (I.D)WASHER -----	[7PCS]	

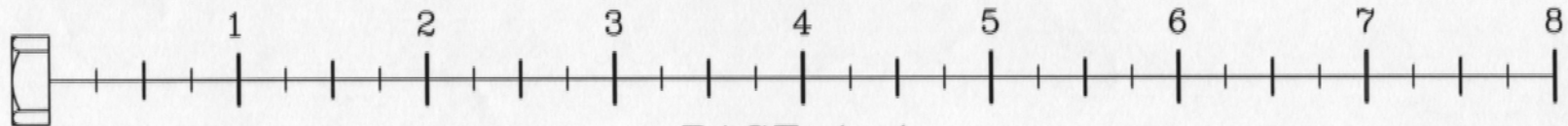
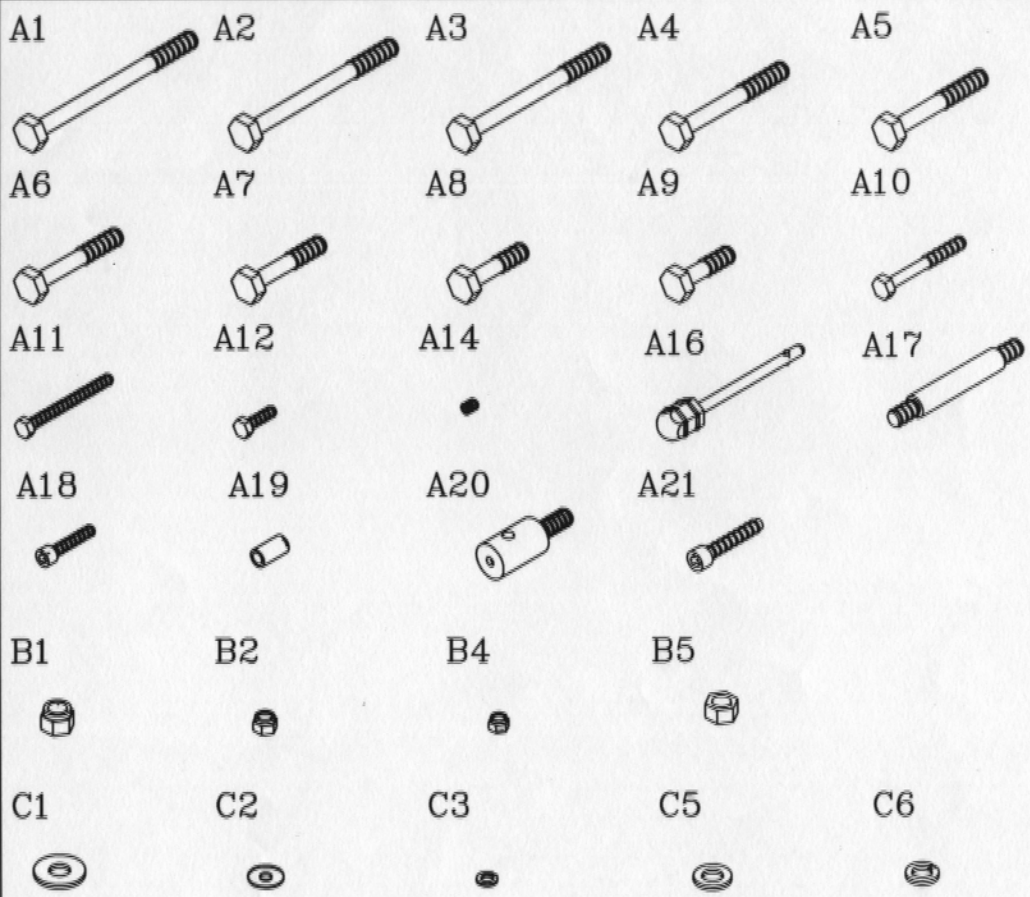

LP-40.3 HARDWARE ILLUSTRATION SHEET

	Qty.
D1. 2"X4" RUBBER DOUNT (9212-009)-----	[4PCS]
D2. 2"X4" END CAP (9211-014)-----	[6PCS]
D3. 2"X2"X1.8t END CAP (9211-005)-----	[1PCS]
D4. 2"X2"X2.5t END CAP (9211-006)-----	[1PCS]
D5. $\phi 3/4$ " PULLEY SPACER (8110-017)-----	[4PCS]
D6. $\phi 4$ " RUBBER DONUT (9310-017)-----	[2PCS]
D7. $\phi 4 1/2$ "X $\phi 3/8$ " PULLEY (9213-010)-----	[1PCS]
D8. $\phi 4 1/2$ "X $\phi 1/2$ " PULLEY (9213-010)-----	[4PCS]
D9. 60X50 NYLON BUSHING (9211-033)-----	[2PCS]
D13. $\phi 8$ SPRING SNAP LINK (8810-001)-----	[1PCS]
D14. $\phi 16$ X15 STEEL BUSHING (8530-003)-----	[2PCS]
D17. 2690mm STEEL CABLE -----	[1PCS]
D18. 3875mm STEEL CABLE -----	[1PCS]
D19. $\phi 3/4$ "X8L STEEL BUSHING (8110-014)-----	[4PCS]
D20. $\phi 3/4$ " SHAFT COLLAR (9211-046)-----	[2PCS]
D21. TOP PLATE (8400-005)-----	[1PCS]
D22. WEIGHT SELECTOR BAR (8210-042)-----	[1PCS]
D23. $\phi 1$ " ROUND END CAP (9260-021)-----	[2PCS]

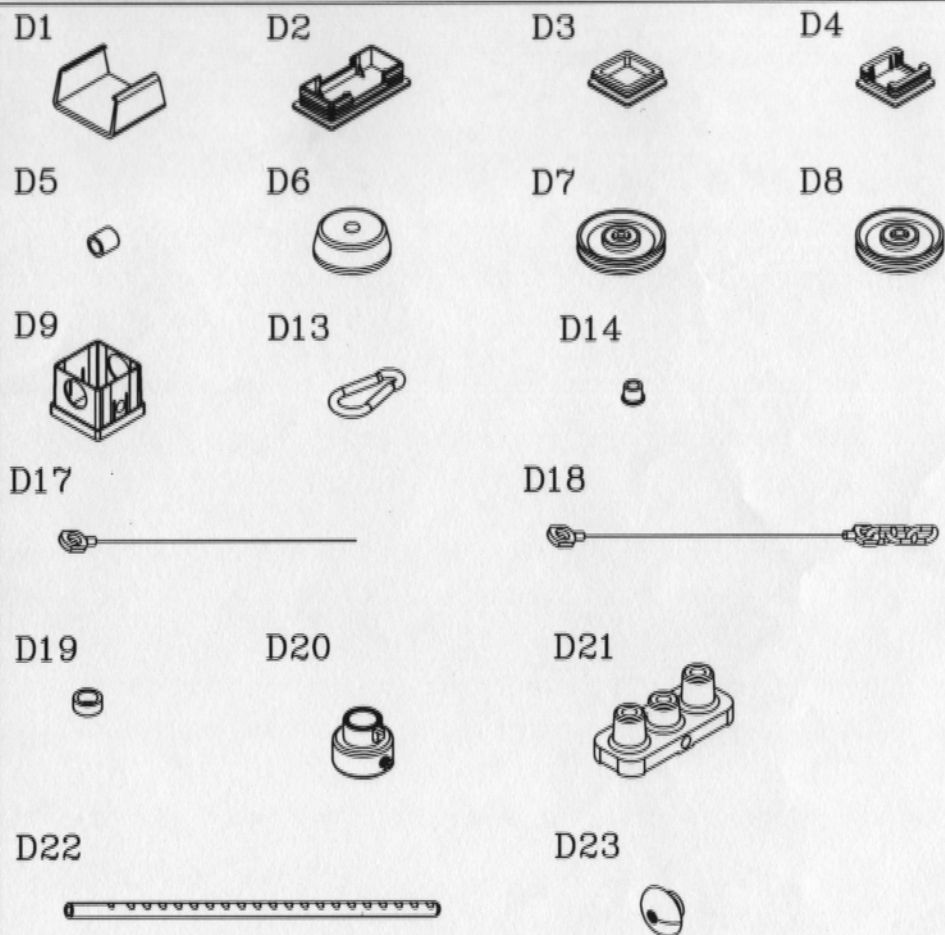

LP-40.3 PARTS ILLUSTRATION SHEET

A [1PCS]

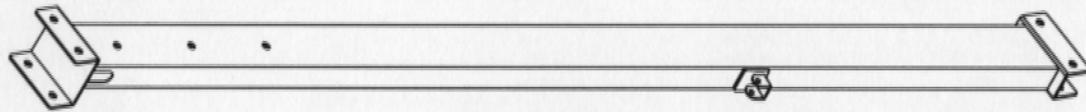

F [1PCS]

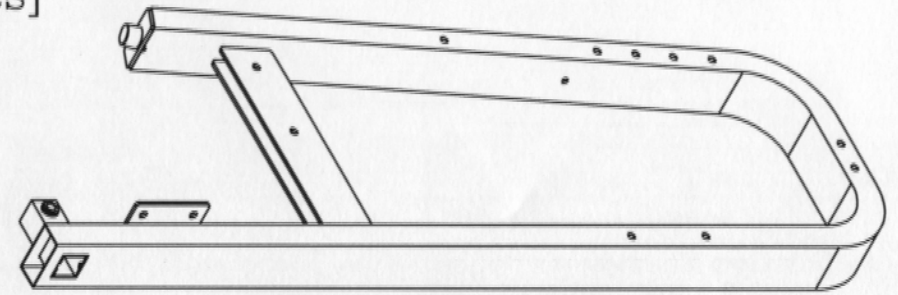

B [1PCS]

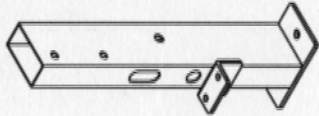

E [1PCS]

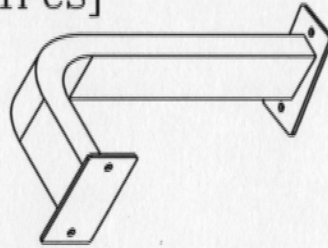

C [1PCS]

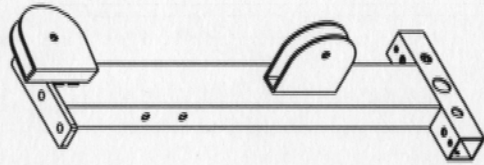

G [1PCS]

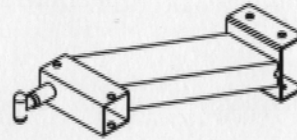

I [1PCS]



L [1PCS]

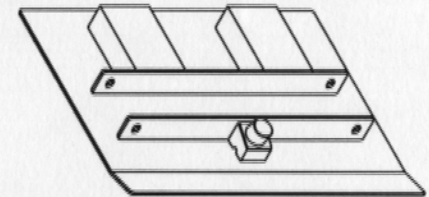

D [1PCS]

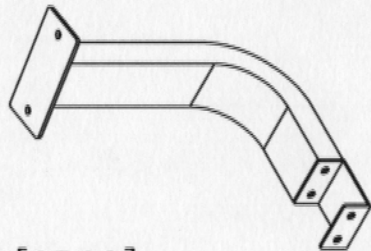

H [1PCS]

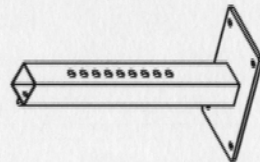

J [1PCS]

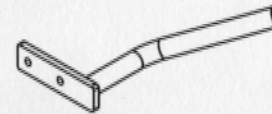

M [1PCS]

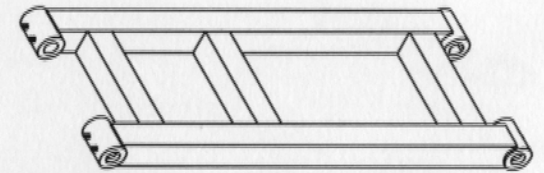

O [2PCS]



K [1PCS]

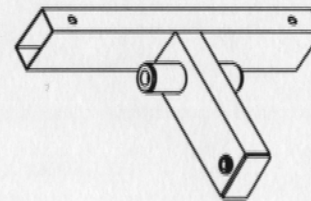

N [1PCS]

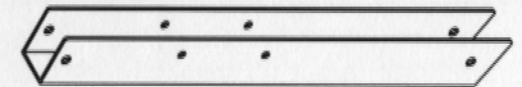

P [1PCS]

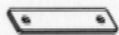

Q [2PCS]



R [1PCS]



S [1PCS]

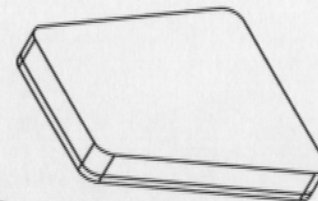

T [1PCS]

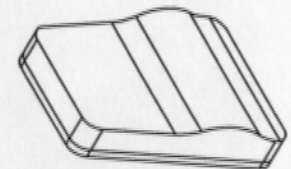

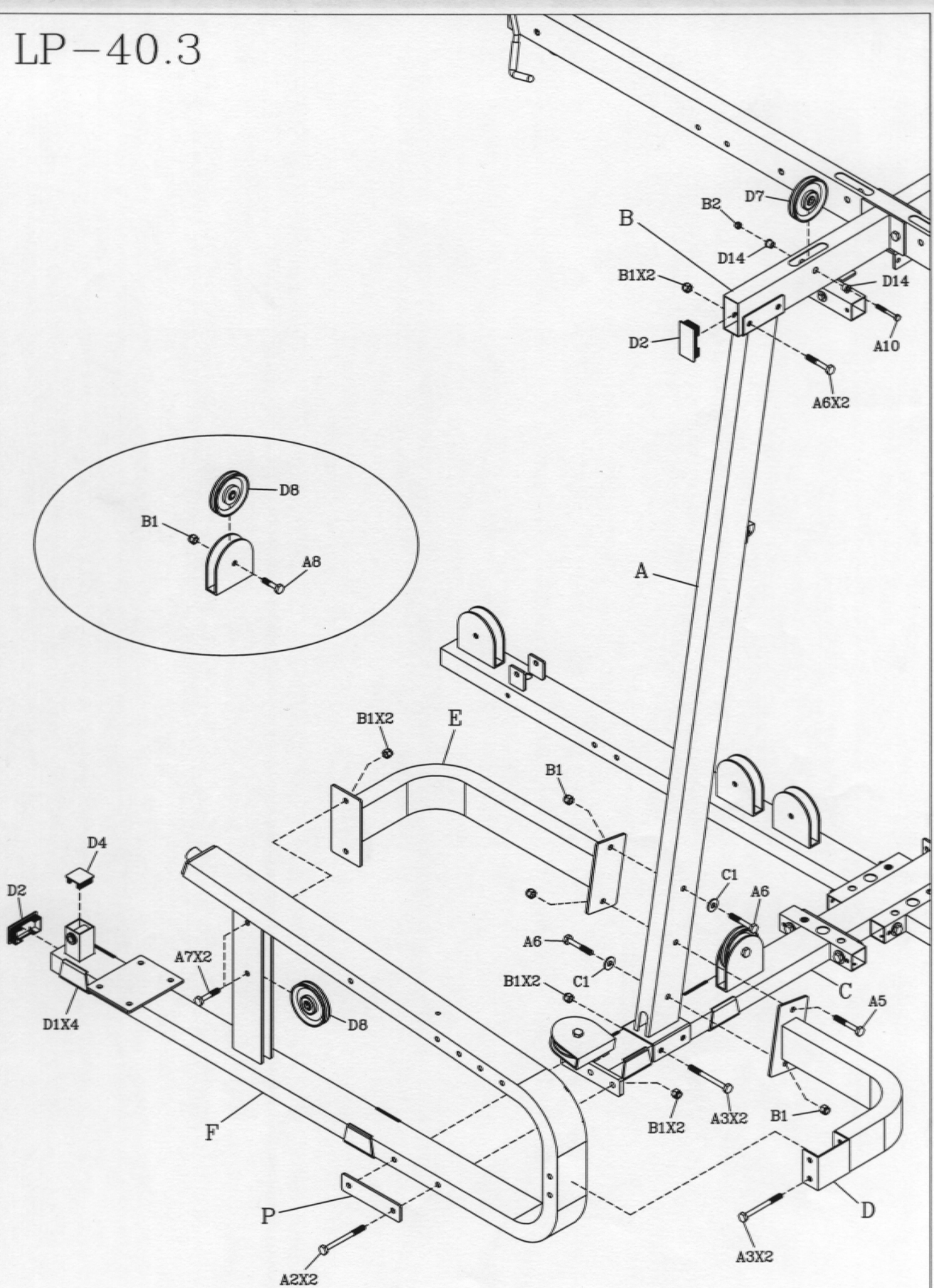

LP-40.3

