

OWNER'S GUIDE

BT 700



 **PHIAATON**



WIRELESS EARPHONES with CHARGING SPEAKER CASE Thank you for purchasing the PHIATON BT 700

- Please follow the directions, and read the guidelines carefully before use. Please keep the owner's guide for future reference.
- Some functions of the BT 700 may not be available when it is paired with certain devices.
- The specifications are subject to change without prior notice for quality improvement.

English

한국어

Deutsch

Français

Español

русский

中國語

CONTENTS

1. SAFETY AND GENERAL INFORMATION
2. COMPONENTS & FEATURES
3. FIRST TIME USE
4. HOW TO WEAR
5. CHARGING
6. TURN THE EARPHONES ON/OFF
7. PAIRING WITH A 'BLUETOOTH DEVICE'
8. USING THE CALL FUNCTION
9. LISTENING TO MUSIC (PLAY & CONTROL)
10. AUDIO TRANSPARENCY
11. THE CHARGING SPEAKER CASE
12. VOICE COMMAND
13. KNOW YOUR BT 700
14. SPECIFICATIONS
15. TROUBLESHOOTING
16. FCC COMPLIANCE INFORMATION
17. IC COMPLIANCE INFORMATION
18. CE COMPLIANCE INFORMATION

1. SAFETY AND GENERAL INFORMATION

- 1) Use a standard USB charging cable (included), with or without a charging adapter. (5V, over 1 A)
* Adapter Not Included.
 - 2) Lower the volume prior to listening to audio to prevent potential damage to eardrums caused by sudden loud sound.
 - 3) Listening to loud music for extended periods of time may cause hearing damage.
 - 4) Do not store the device in places with a temperature higher than 113 °F/ 45 °C.
 - 5) This device is IPX4 sweat and water resistant. Please note that it is not waterproof. Please use caution not to oversaturate with moisture or leave excessive moisture on the device as this can damage the internal components. (For more information, refer to the contact us page within our website –phiaton.com.)
 - 6) Do not attempt to disassemble, modify or repair the device.
 - 7) Do not cause shock to the device.
 - 8) Keep out of the reach of children and pets.
 - 9) Do not tug on cords or touch power plugs with wet hands.
 - 10) Do not use the device near microwave ovens or wireless LAN adaptors.
 - 11) When the product is not being used, please keep it in the Charging Speaker Case.
 - 12) When cleaning the device, use a clean dry cloth to wipe the device clean. (Do not use solvents.)
 - 13) To clean the ear tips, remove from earphones, wash with warm water, dry completely and check for debris before reattaching.
 - 14) Replacement ear tips can be purchased from Phiaton Customer Service.
Email us at SUPPORT@PHIATON.COM
 - 15) Using the device while walking or driving may prevent user from hearing important sounds such as signals or alarms and may impose hazardous conditions on yourself or others. Heed caution during use.
 - 16) The radio waves of this device may affect electronic medical devices. If you use any electronic medical device, consult your doctor or the medical device company before you use it.
- ※ Use the BT 700 only for its intended purposes.
- ※ This device cannot be used for purposes related to human safety as it may cause radio interference during operation.

2. COMPONENTS & FEATURES

1) Components

- BT 700
- Charging Speaker Case
- Micro USB 5-pin Charging Cable
- 4 Sizes of Silicon Ear Tips
- Quick Guide
- Warranty Card

2) Features

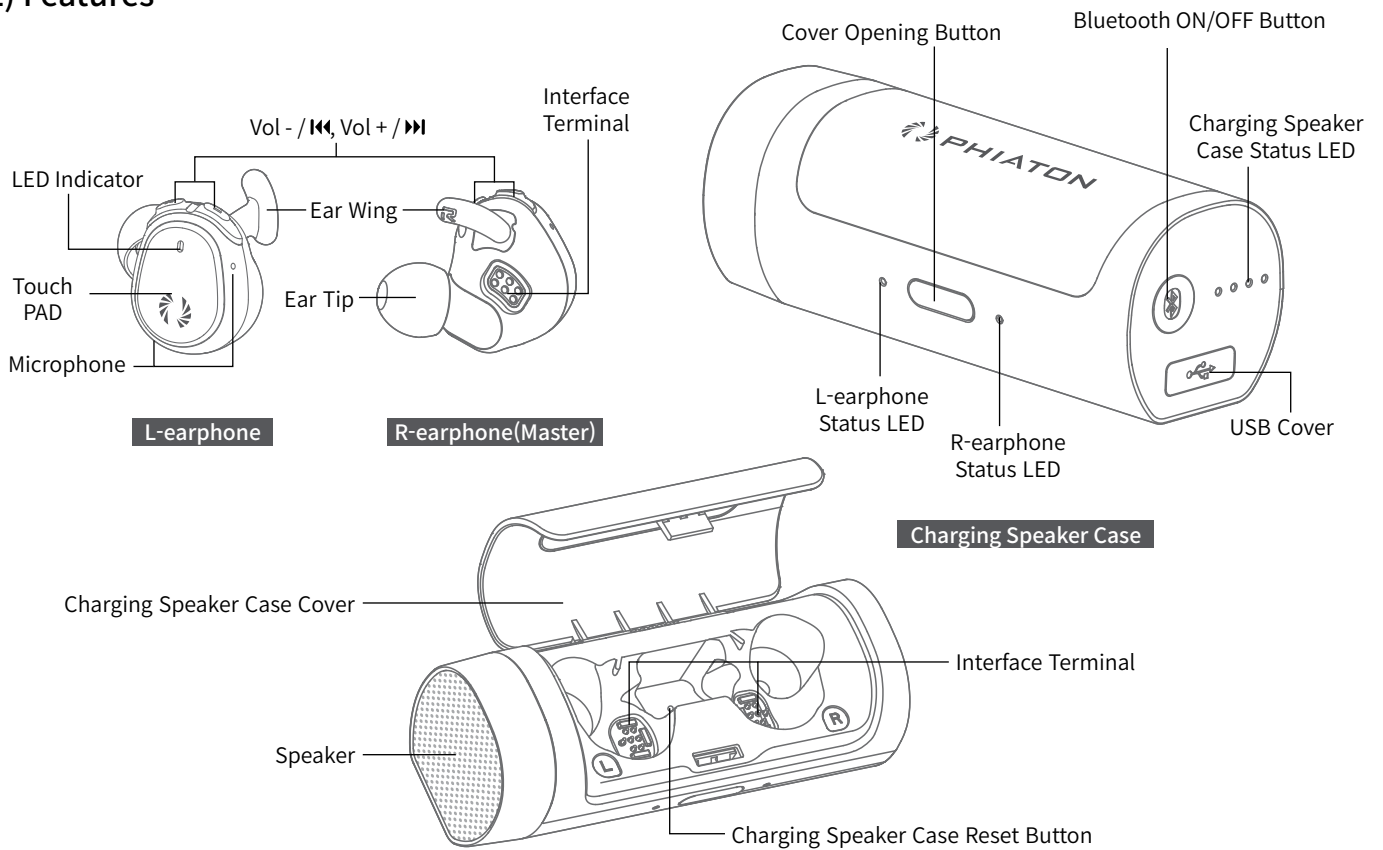

※R-earphone is the master earphone.

3. FIRST TIME USE

- 1) For first time use of the BT 700, put the earphones into the Charging Speaker Case and charge the earphones for at least 30 minutes.
- 2) After at least 30 minutes of charging, take the charged L and R-earphone out from the Charging Speaker Case.

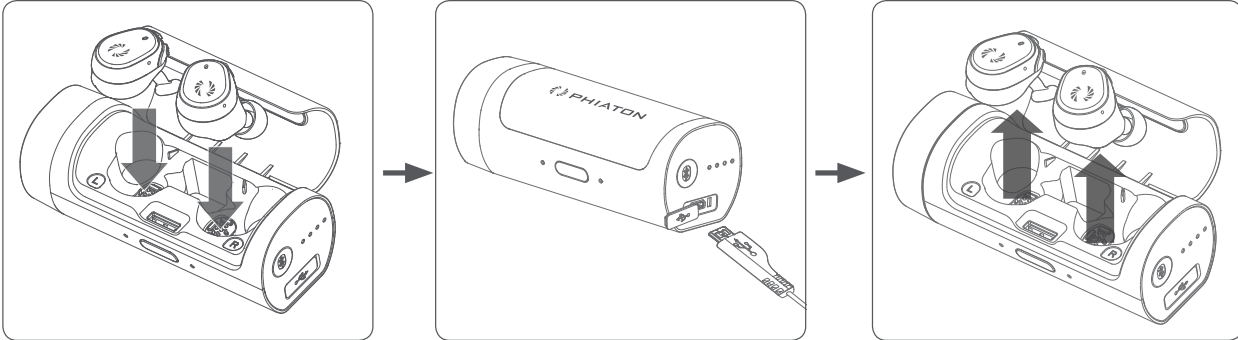

- 3) The L and R-earphone are turned on automatically and connected to each other.
- 4) After the L and R-earphone are connected to each other automatically, the LED Indicator of both earphones will flash in blue and red.
- 5) Within the Bluetooth settings of your device search and select 'BOLT BT 700'.
- 6) LED indicator will flash blue once paired to the device.

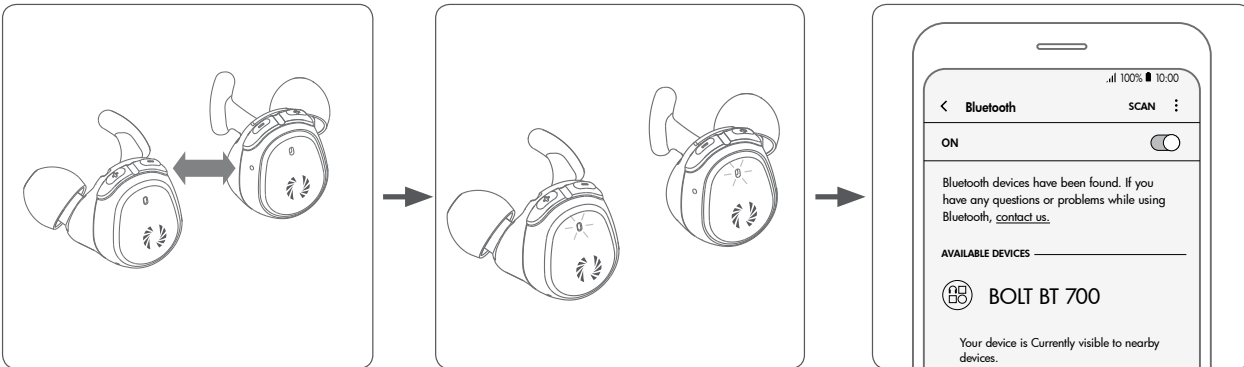

4. HOW TO WEAR

- 1) Hold the earphone body naturally so that the 'ear-wing' is facing upward.
- 2) Gently insert the ear tip into the ear canal.
- 3) Turn the earphone slightly so that the 'ear-wing' of earphone fits comfortably into the upper part of canal (cymba of concha) and push it inward.

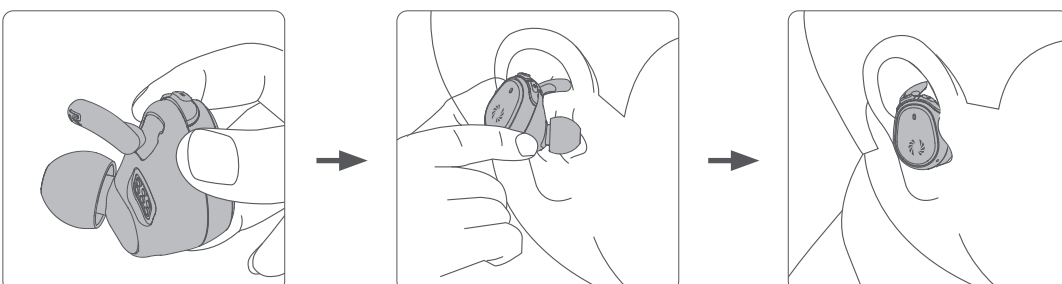

5. CHARGING

1. Charging the Earphones

- 1) Place the L-earphone and R-earphone in the Charging Speaker Case.
- 2) Make sure the LED light of earphones are red before closing the Charging Speaker Case Cover.
If charging properly it will be red.
- 3) Close the Charging Speaker Case Cover then push the 'Bluetooth ON/OFF Button' to check the L and R-earphone status by checking the 'Earphones LED Indicator' on the front of the case.

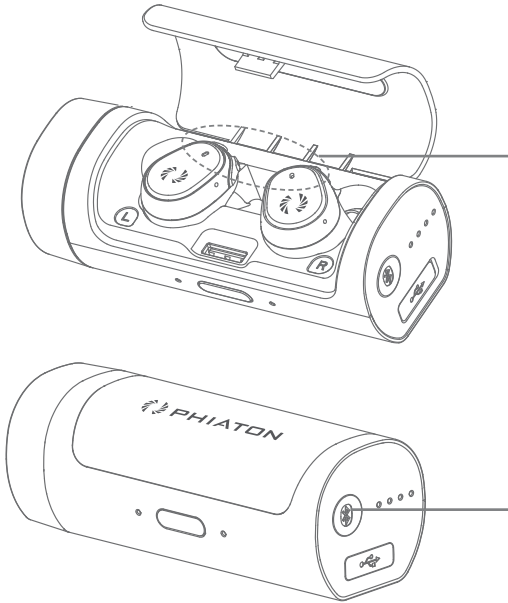

Earphone Status	LED Indicator
Charging	Red Light
Charging Complete	LED Off

Charging Speaker Case Status LED	Status LED of Earphones
Charging	Red Light
Charging Complete	Blue Light

- ※ Time needed to fully charge may be different between the L-earphone and R-earphone depending on the battery level remaining.
- ※ Once the earphones are fully charged, the Charging Speaker Case will go into Sleep Mode. The speaker function of Charging Speaker Case can not be used in Sleep Mode.
 - ▶ 13. Know Your BT 700', 1) BT 700 'Sleep Mode'

2. Charging the Charging Speaker Case

- 1) Open the USB cover on Charging Speaker Case and connect the USB charging cable.
It is recommended to always use the original charging cable that came with your BT 700.
- 2) Connect the USB charging cable to a computer, laptop or an USB adaptor (rating 5V/over 1A) to begin charging.

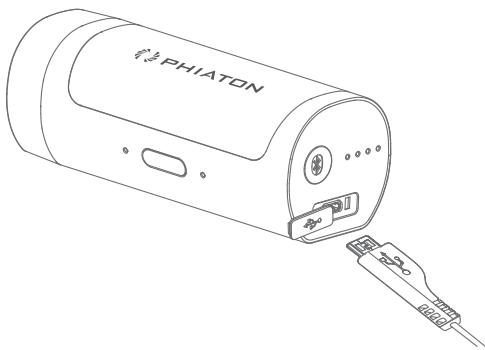

Charging Speaker Case Status LED	Charging Status
4 Blue LED ON	Battery (Very High)
3 Blue LED ON	Battery (High)
2 Blue LED ON	Battery (Mid)
1 Blue LED ON	Battery (Low)
All LED OFF	Charging Completed

※ You can check the battery level on Charging Speaker Case when charging.

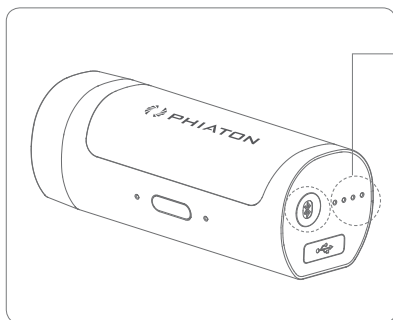
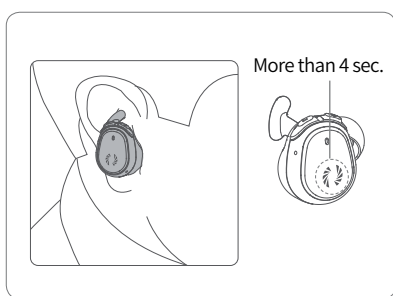

3. Checking Battery Level

1) Checking Battery Level while in use

- Voice Guidance: When you touch the touch pad for more than 4 seconds you will hear battery level status by voice.

2) Checking Battery Level of the Charging Speaker Case

- Push the 'Bluetooth ON/OFF Button' of the Charging Speaker Case and you will see Battery Level display on the LED Status.

Charging Speaker Case Status LED	Battery Status
4 Blue LED ON	Remaining Battery (Very High)
3 Blue LED ON	Remaining Battery (High)
2 Blue LED ON	Remaining Battery (Mid)
1 Blue LED ON	Remaining Battery (Low)
All LED OFF	Out of Battery

※ If close to 'Out of Battery' (even when 1 BLUE LED is ON), earphones will not automatically turn on even if you have just removed from Charging Speaker Case.

6. TURN THE EARPHONES ON/OFF

1) Automatically turning the Earphones ON/OFF

- Use the Charging Speaker Case

Earphones will automatically turn ON/OFF when placed IN/OUT of the Charging Speaker Case.

※ The automatic Power ON/OFF function using the Charging Speaker Case is available only when there is enough battery in the Charging Speaker Case to activate this function.

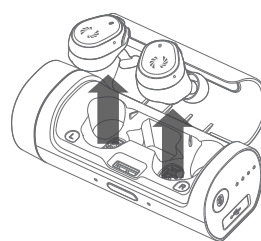

ON: EARPHONES OUT

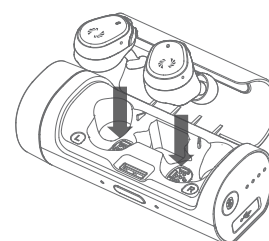

OFF: EARPHONES IN

2) Power ON/OFF using [VOL+] Button

- Press and hold the [Vol+] button for about 2 sec. to turn on.

- Press and hold the [Vol+] button for about 3 sec. to turn off.

Earphones	Operation	LED Indicator
Power ON	[VOL+] Press and Hold for about 2 sec.	Violet light turns on for 2 sec.
Power OFF	[VOL+] Press and Hold for over 3 sec.	Red light blinks 4 times

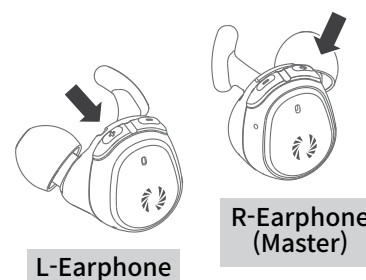

3) Standby Mode

- While power is on, if the BT 700 is not in 'Pairing Mode' or not connected to a 'Bluetooth Device', it will go into 'Standby Mode'.

- While in 'Standby Mode', if the BT 700 is not connected to a 'Bluetooth Device' within 5 minutes, it will automatically turn off.

※ When turning on power using the earphone button, turn on both earphones by pressing the [Vol+] button.

※ When turning the earphones off, power off the right earphone (master) and the left earphone will turn off automatically.

7. PAIRING WITH A 'BLUETOOTH DEVICE'

1. Items to check before pairing

- Turn on the Bluetooth function of the 'Bluetooth Device' you want to connect with the BT 700.
- Place the BT 700 within 3 feet of the 'Bluetooth Device' you want to connect.

2. Pairing the earphones to a new device

1) While power is off, press and hold the [VOL +] button of the R-Earphone for about 5 seconds.

(Do not release button when you hear 'power on', continue holding until hear "Pairing mode activated".)

The LED display will flash in blue and red.

※ Regarding the power OFF, refer to step 6 above. Turning the Earphones ON/OFF'.

2) Within the Bluetooth settings of your device search and select 'BOLT BT 700'. Check that pairing is complete.

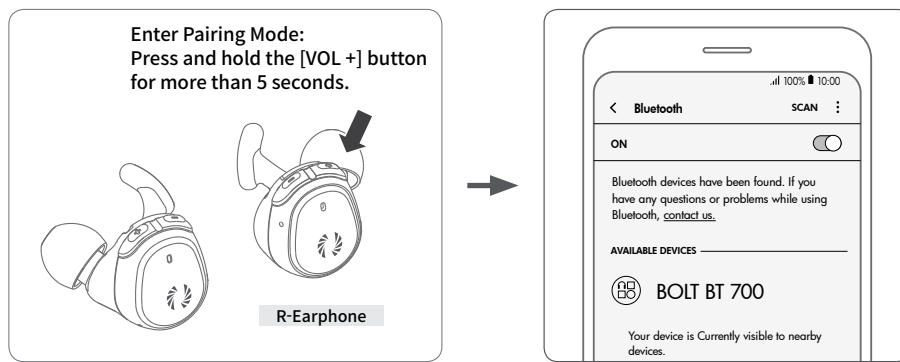

3) Once R-Earphone (master) is connected to Bluetooth device, L-Earphone will pair with right earphone.

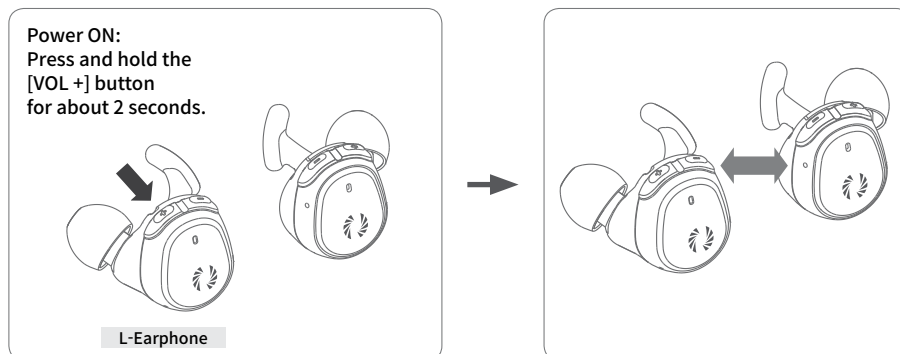

3. Re-connecting a Disconnected Device

- Once the BT 700 has been paired to a device, it will automatically connect when the BT 700 is powered on.
- If the Bluetooth becomes disconnected due to range being exceeded, it will not reconnect when you are back within range. You must reconnect to your device within the discoverable range (3 feet).
- If auto connection is not working, double tap the touch pad of the R-earphone to connect to a previously paired device.

4. Re-connecting between L-earphone and R-Earphone

- Double tap the touch pad on L-earphone when power is on to connect to R-earphone.
- Alternatively, turn off and on both earphones or place both earphones in the Charging Speaker Case and take them back out.

8. USING THE CALL FUNCTION

1) Accepting a Call

- When an incoming call tone is heard, double tap either touch pad to receive the call.
- While listening to music, double tap either touch pad to receive the call.

(Adjusting call volume : press the [Vol +]/[Vol -] to turn up or down volume.)

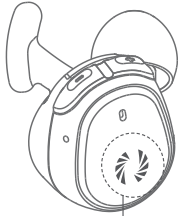

Touch PAD

Call Function	Operation
Accepting a Call	●● Double Tap Touch PAD
Ending a Call	(Beep Sound Twice)

2) Ending a Call

- To end the call, double tap the touch pad and call will end.
- If you were listening to music when you received the call, the music will resume automatically.

3) Rejecting a call

- When incoming call tone or call vibration comes in, press and hold the [Vol -] Button for about 1 second until you hear 'Call Ignored'. This will indicate call has been rejected.

4) Mute Mic ON/OFF

- Press and hold [Vol -] button to mute Mic on. (Your voice will not be transmitted.)
- And press and hold [Vol -] button again to mute Mic off.

5) Call Waiting (Supported if this feature is available through your service provider.)

- Press and hold the R-earphone touch pad to place the current call on hold and to pick up the call waiting.
- (Only the R-earphone supports this feature.)

6) Calling by Voice (Supported if voice command is available on your mobile phone.)

- Shortly press the [Vol +] and [Vol -] button at the same time while paired with 'Bluetooth Device'.

- ※ Both touch pads of L/R earphone supports 'receiving calls' and 'end calls'.
- ※ When connected to a call, voice can be heard with both L/R earphones.
- ※ Functions can be limited or differ depending on the 'Bluetooth Device' connected.

9. LISTENING TO MUSIC (PLAY & CONTROL)

1) Playing Music

- Double tap the touch pad of R-earphone to play music from the 'Bluetooth Device'.
- While music is playing, double tap the touch pad of R-earphone to pause.

2) Controlling Volume and Using Seek

- Press the [Vol +]/[Vol -] to control the volume.
- Press and hold the VOL [Vol +]/[Vol -] button for over 1 sec. to go to the previous / next song. (Until you hear the 'beep' signal.)

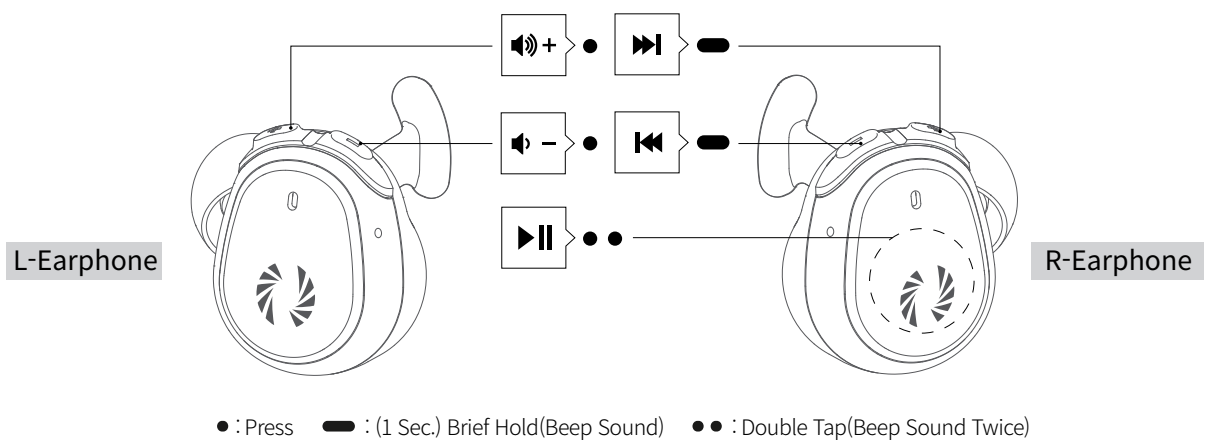

10. AUDIO TRANSPARENCY

By activating the 'Audio Transparency Function', you can hear surrounding sound during music play or standby mode.

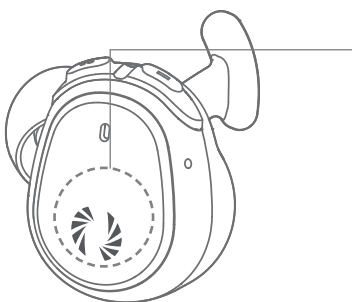

Select	Operation
L-Earphone	●● Double Tap Touch PAD(Beep Sound Twice)

11. USING THE SPEAKER FUNCTION

Place the BT 700 Earphones in the Charging Speaker Case and you can enjoy music through the speaker of the Charging Speaker Case via Bluetooth.

- 1) Place Earphones into the Charging Speaker Case.
- 2) Press the 'Bluetooth ON/OFF' button for 2 seconds and connect to a 'Bluetooth Device'.

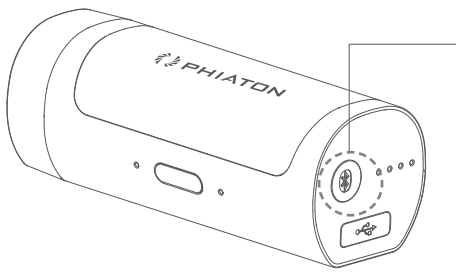

Speaker Mode	Bluetooth ON/OFF Button	Voice guidance for speakers	Status LED of Earphones
ON	Press and hold for 2 seconds.	'Power On, Device Connected'	Blue LED On
OFF	Press and hold for 2 seconds.	'Power Off'	LED Off

- 3) Play music on your 'Bluetooth Device'.
- 4) When listening through the Charging Speaker Case, the control features such as play/pause, volume control or rewind/fast-forward will be controlled through your 'Bluetooth Device'.

- ※ Please turn off Bluetooth by using the 'Speaker case Bluetooth ON/OFF Button' after use to prevent battery discharge.
- ※ If you cannot hear music, check that the R-earphone is placed properly in the 'Charging Speaker Case'.

12. VOICE COMMAND

You can enable the voice command function by quickly pressing [Vol +] and [Vol -] briefly at the same time (you will hear a 'beep' signal) while paired to a 'Bluetooth Device'.

Operation	Status
Press both [Vol +] and [Vol -] (beep signal)	SIRI, Google Assistant etc.

- ※ This function can be limited or differ depending on the 'Bluetooth Device' connected.

13. KNOW YOUR BT 700

1) BT 700 'Sleep Mode'

- Sleep mode can help save battery life.
- Sleep Mode will be activated 1 minute after the earphones are fully charged.
(Sleep mode will not be activated if the speaker is in use.)
- When you press the Bluetooth button while in Sleep Mode, LED indicator located beside the Cover will flash in Red and Charging Speaker Case will not be powered on.
- When trying to use Bluetooth Speaker while in Sleep Mode, take R-earphones out and place in the Charging-Speaker Case and press and hold Bluetooth button.

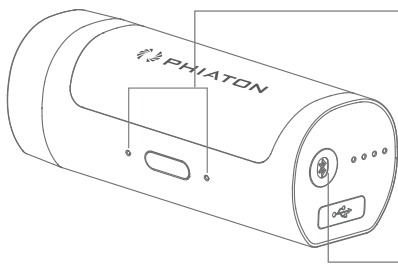

Mode	LED Indicator
Sleep Mode	Red LED On
Normal setting	Blue LED

Press and hold for 2 seconds

2) How to store the earphones when Charging Speaker Case has low battery or fully discharged.

- When Charging Speaker Case has low battery or fully discharged, the earphones will not automatically turn off when you place them in the case. You must manually turn off the earphones before you place back into the Charging Speaker Case.

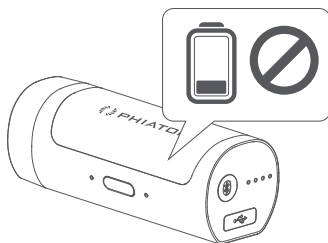

Fully discharged case

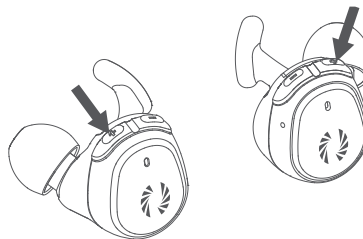

Power off manually by pressing the [VOL +] button

- * If you store the earphones in the Charging Speaker Case without turning the earphones off, you may encounter difficulties receiving phone calls as your 'Bluetooth Device' may be connected to the earphones.

3) If the L/R earphones do not connect with each other

- If the L/R earphones are not automatically connected to each other even if you power off/on, you will need to manually connect.
- While R-earphone is powered off, press and hold both [Vol +]/ [Vol -] of R-earphone until purple LED blinks. And then, repeat same operation for L-earphone.
- Place both earphones closeby. Both earphones will be connected to each other once LED blinks in Blue.

4) Resetting the Device

- To reset earphones to factory setting, first place the earphones into "pairing mode" then, press [Vol -] button for over 5 seconds. When LED indicator flashes Purple 5 times resetting is done.

14. SPECIFICATIONS

1) BT 700 Earphones

- Communication Network: Bluetooth 5.0
- Output Power: Power Class 2
- Max. Communication Range: Discoverable within 10 m
- Full Charging Time: 2 hours
- Fast Charging: Support, 15 min. Charging - 1 hr Playing
- Calling Time: 5 hrs Max.
- Music Play Time: 5 hrs Max.
- Standby Time: 94 hrs Max.
- Operating Frequency: 2.4 GHz (2.402 GHz - 2.480 GHz)
- Bluetooth Profile Support: HFP v1.7 / HSP v1.2 / A2DP v1.3 / AVRCP v1.6
- Audio Codec: SBC, AAC
- Battery: Lithium Ion, DC 3.7 V / 85 mAh
- Microphone Frequency: 100 ~ 8,000 Hz
- Microphone Sensitivity: -42 dB
- Talk ECNR: Support with two Microphones
- Driver Unit: Balanced Armature
- Driver Unit Sensitivity: 97 dB/mW
- Driver Unit Impedance: 40 ohms
- Driver Unit Frequency Response: 20 Hz - 20 KHz

2) Charging Speaker Case

- Input Power: DC 5V / over 1 A
- Full Charging Time include Earphones: 2.5 hours
- No. of 'BT 700' charging with Charging Speaker Case: 3 times
- Speaker Output: 3W Max.
- Music Play Time via BT 700 & Speaker: 8 hrs Max.
- Standby Time(BT OFF): 220 hrs Max.
- Dimensions(L x W x H): 94 X 37 X 36 mm / 3.70 X 1.45 X 1.41 in
- Weight with 'BT 700 Earphones': 93 g / 0.21 lb
- Operating Temperature: -20 ~ 45 °C / -4 ~ 113 °F

* The Specifications are subject to change without prior notice for quality improvement.

15. TROUBLESHOOTING

1) The power does not turn on:

- Charge the device. If the power does not turn on even after charging, contact Phiaton Customer Service.

2) The device does not charge:

- Check whether the USB charging cable has been properly connected with the device.
- Check whether the PC power is on and that it has been properly connected.
- When using a separately purchased USB AC adaptor, check to see that it has been properly connected.

3) The devices does not pair:

- Check whether the power of the 'Bluetooth Device' you want to connect is on.
- Check whether the Bluetooth feature within the 'Bluetooth Device' you want to connect is enabled.
- Check whether the 'Bluetooth Device' you want to connect is within the supported range.
(Pairing is supported only when within 3 feet.)
- Check whether the Bluetooth profile within the 'Bluetooth Device' is compatible.

4) Music cannot be played:

- Check whether the power of the device and 'Bluetooth Device' is on.
- Check whether music is being played within the connected 'Bluetooth Device'.
- Check whether the volume within the connected 'Bluetooth Device' is low.
- When using an extension cord, check to see that the plug is properly connected.

5) Noise is heard or the sound lags:

- Check whether there is a nearby electronic device using the 2.4 GHz frequency band.
- Check whether the connected 'Bluetooth Device' is far away from this device.
(Maximum communication range: within 33 feet.)

6) The music sound quality is low:

- If the 'Bluetooth Device' you are trying to connect with this device is accessed to HSP, change the access to A2DP.

7) The other party cannot be heard while on a call:

- Check whether the power of the 'Bluetooth Device' you want to connect is on.
- Access Bluetooth through HFP or HSP.
- Check whether the volume within the connected 'Bluetooth Device' is low.

8) Product does not operate or operation has stopped:

- For earphones, place in Charging Speaker Case and press [Vol +] shortly.
Reset will be done once LED Indicator on earphones blinks 1 time.
- For Charging Speaker Case, press the reset button located between the earphones holders.
Reset will be done once you hear a clicking sound.
- Pairing information is not deleted even when the earphones are reset.

9) The device is paired with PC/Laptop but does not work:

- PC/Laptop is equipped with various Bluetooth drivers depending on the manufacturer and it is possible it does not support BT 700.
- Please contact to PC/Laptop manufacturer to download the latest software driver or for further assistance in connecting to a 'Bluetooth Device'.

16. FCC COMPLIANCE INFORMATION

FCC ID: V2R-BT700

This device complies with part 15 of FCC Rules. Operation is subject to the following two conditions:

(1) This device may not cause harmful interference, and (2) this device must accept any interference received, including interference that may cause undesired operation.

Information to the user:

NOTE: This equipment has been tested and found to comply with limits for a Class B digital device, pursuant to part 15 of the FCC Rules. These limits are designed to provide reasonable protection against harmful interference in a residential installation. This equipment generates, use and can radiate radio frequency energy and, if not installed and used in accordance with the instructions, may cause harmful interference to radio communications. However there is no guarantee that interference will not occur in a particular installation. If this equipment does cause harmful interference to radio or television reception, which can be determined by turning the equipment off and on, the user is encouraged to try the correct interference by one or more of the following measures:

- Reorient or relocate the receiving antenna.
- Increase the separation between the equipment and receiver.
- Connect the equipment into an outlet on a circuit different from that to which the receiver is connected.
- Consult the dealer or an experienced radio/TV technician for help.

CAUTION TO USER: Changes or modifications not expressly approved by the party responsible for compliance could void the user's authority to operate the equipment.

17. IC COMPLIANCE INFORMATION

This device complies with Industry Canada license-exempt RSS standard(s).

Operation is subject to the following two conditions:

(1) This device may not cause interference, and (2) this device must accept any interference, including interference that may cause undesired operation of the device.

This equipment complies with IC radiation exposure limits set forth for an uncontrolled environment and meets RSS-102 of the IC Radio Frequency (RF) Exposure rules. This equipment has very low levels of RF energy that are deemed to comply without testing of specific absorption ratio (SAR).

18. CE COMPLIANCE INFORMATION

Phiaton, hereby declares that this BT 700 is in compliance with the essential requirements and other relevant provisions of directive 1999/5/EC.