

OWNER'S GUIDE

BonoBuds Plus





BonoBuds Plus

Hybrid Active Noise Cancelling Earbuds

Thank you for purchasing the PHIATON BonoBuds Plus

- Please read the guidelines carefully before use and keep the owner's guide for future reference.
- Some functions of the PHIATON BonoBuds Plus may not be available when it is paired with certain devices.
- The specifications are subject to change without prior notice for quality improvement.

CONTENTS

1. Safety and General Information
2. Package Contents
3. Pairing
4. Charging
5. Power ON/OFF
6. Connecting/pairing with other Bluetooth devices
7. Managing Music (play & control)
8. Call Function
9. Noise Cancelling Function
10. Ambient Mode (Audio Transparency)
11. Activate the voice command function
12. Product Reset
13. Specifications
14. Troubleshooting
15. Certification

1. Safety and General Information

- 1) Use a standard USB charging cable (included), with or without a charging adapter. (5V, over 1 A)
 - ※ Adapter not included.
 - 2) Lower the volume before using the earbuds to prevent potential damage to eardrums caused by sudden loud sound.
 - 3) Listening to loud music for extended periods of time may cause hearing damage.
 - 4) Do not store the device in places with a temperature higher than 113 °F / 45 °C.
 - 5) This device is IPX4 sweat and water resistant. It is not waterproof. Please use with caution not to oversaturate with moisture or leave excessive moisture on the device as this can damage the internal components. In case the device gets wet, please contact our customer service for support. Visit our FAQ page for more information.
 - 6) Do not attempt to disassemble, modify, or repair the device.
 - 7) Do not cause shock to the device.
 - 8) Keep out of the reach of children and pets.
 - 9) Do not tug on cords or touch power plugs with wet hands.
 - 10) Do not use the device near microwave ovens or wireless LAN adaptors.
 - 11) When the product is not being used, please keep it in the Cradle.
 - 12) When cleaning the device, use a clean dry cloth to wipe the device clean. Do not use solvents.
 - 13) To clean the silicone ear tips, remove from earphones, wash with warm water, dry completely and check for debris before reattaching
 - 14) Replacement ear tips can be purchased from PHIATON Customer Service.
 - 15) Using the device while walking or driving may prevent the user from hearing important sounds such as signals or alarms and may impose hazardous conditions on yourself and/or others. Heed caution during use.
 - 16) The radio waves on this device may affect electronic medical devices. If you use any electronic medical devices, consult your doctor or the medical device company before using.
- ※ Use PHIATON BonoBuds Plus only for its intended purposes.
- ※ This device cannot be used for purposes related to human safety as it may cause radio interference during operation.

2. Package Contents

1) Package Contents

- BonoBuds Plus Earbuds
- BonoBuds Plus Charging Case
- 3 Sizes of Silicon Ear Tips (M Silicone tips come pre-attached.)
- USB – C Type Cable
- Quick Guide
- Warranty Card
- Extended Warranty Card

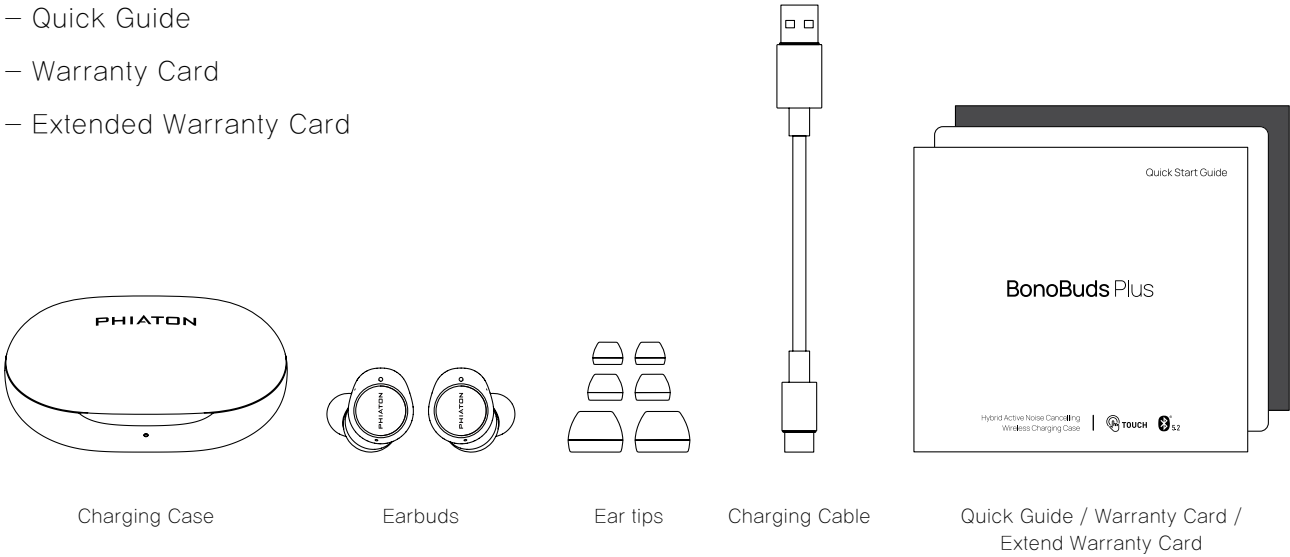

2) Components & Features

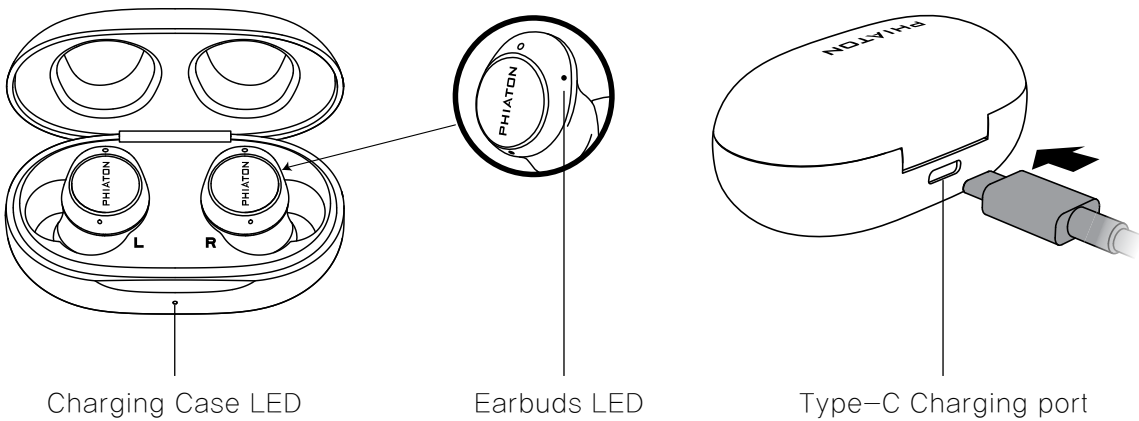

3. Pairing

When you take the earbuds out of the case, you can proceed with 'pairing'.

Remove the film on the earbuds and charge for at least 10 minutes before first time use.

- ① Turn the Bluetooth on of your device.
 - ② When earbuds is taken out of the case, the earbuds are automatically turned on and ready for pairing after 5 seconds.
 - ③ Select 'PHIATON BonoBuds Plus' from the 'Bluetooth Settings' of the device to be connected with the earbuds.
 - ④ When the earbuds are connected to the device, voice guidance is provided. 'Device connected'
- ※ When you take the earbuds out of the case, they automatically connect to the most recently connected device.
※ You need to repeat this procedure every time you pair 'PHIATON BonoBuds Plus' with a new device.

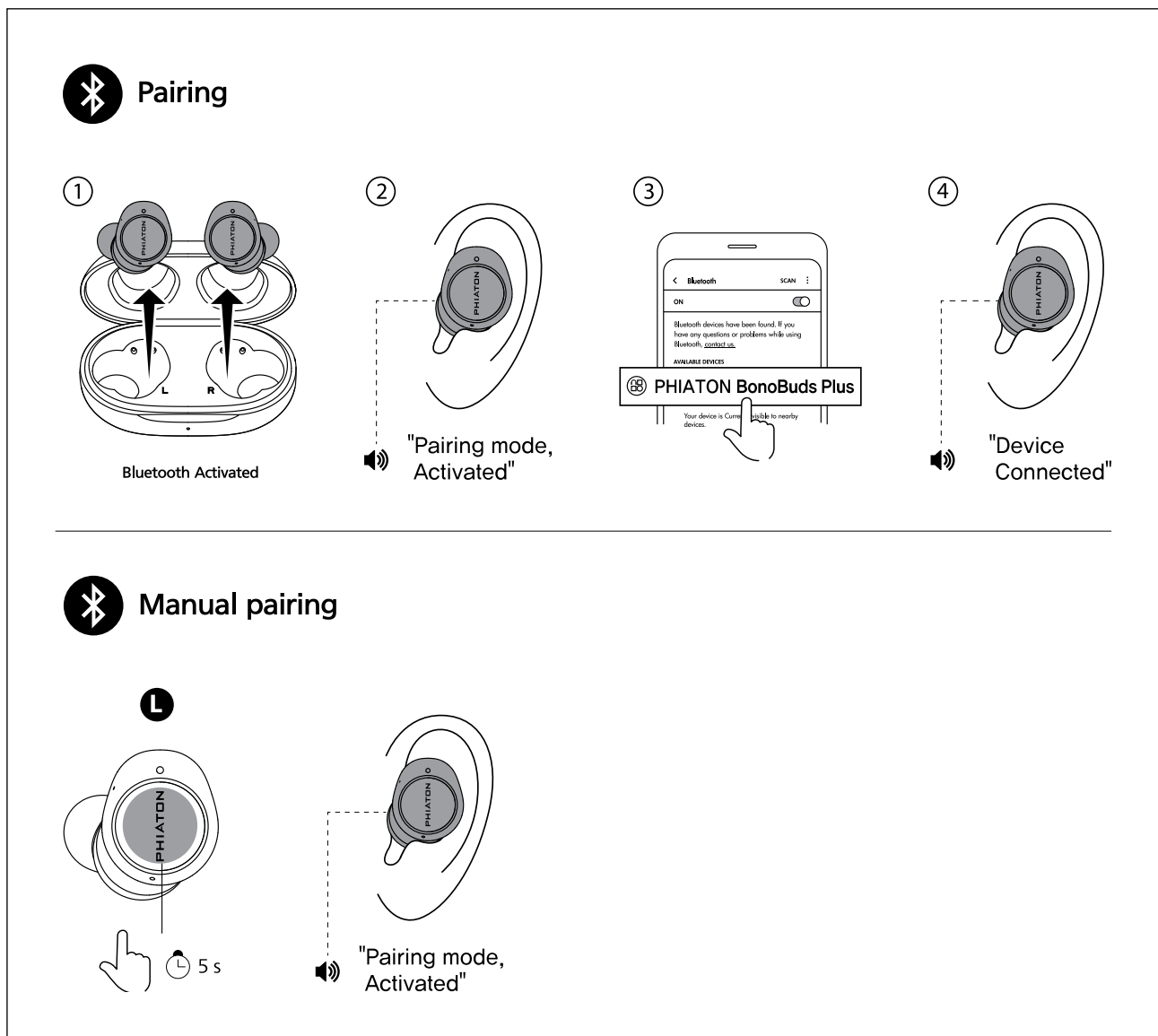

4. Charging

The earbuds begin charging from the moment they are stored in the case.

Case supports USB Type C charging

4-1. Charging the Earbuds

- ① Earbuds start charging when you put them in the case.
- ② The LED on the earbuds turns on and the earbuds are charging.

※ When the earbuds are fully charged, the 'Earbuds Charging Status LED' on the case turns off.

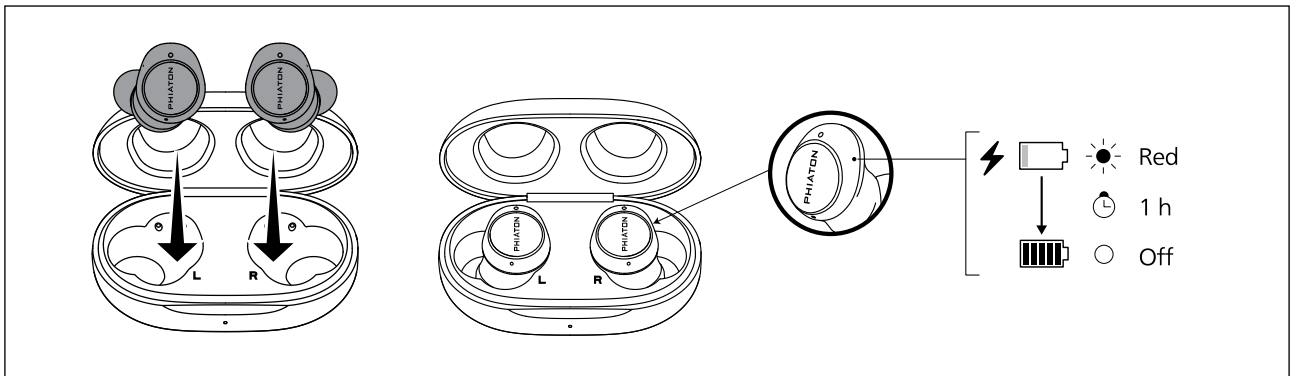

4-2. Charging the Case

1) Using the Charging cable

- ① Connect the 'Type-C charging cable' to the port on the back of the case.
- ② Check that the 'Case Charging Status LED' on the front of the case is on.

※ The red LED means the earbuds can't be fully charged using the remaining battery of the case.

※ The white LED means the earbuds can be fully charged more than once using the remaining battery of the case.

※ When the case is fully charged, the 'charging status LED' turns off.

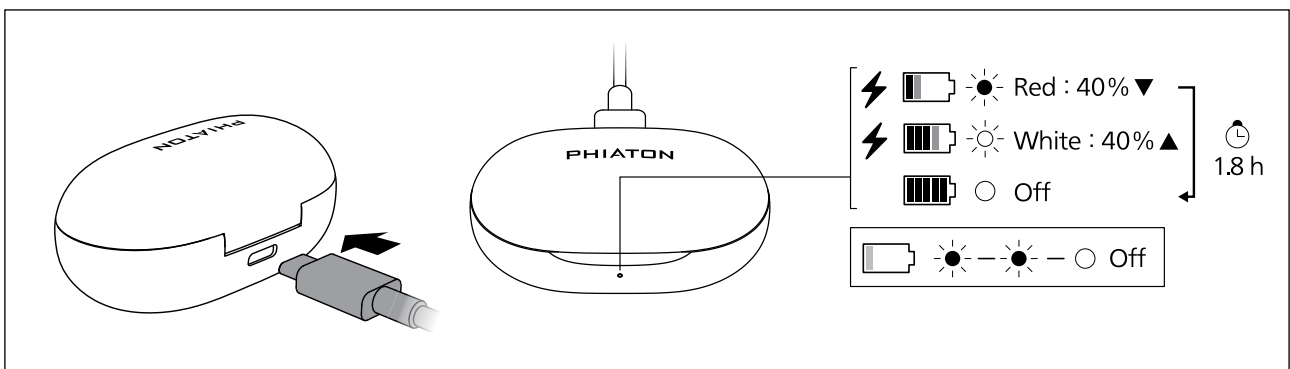

2) Wireless Charging

① Please use the case so that it is centered on the wireless charging pad.

② Check that the 'Case Charging Status LED' on the front of the case is on.

- ※ The red LED means the earbuds can't be fully charged using the remaining battery of the case.
- ※ The white LED means the earbuds can be fully charged more than once using the remaining battery of the case.
- ※ When the case is fully charged, the 'charging status LED' turns off.

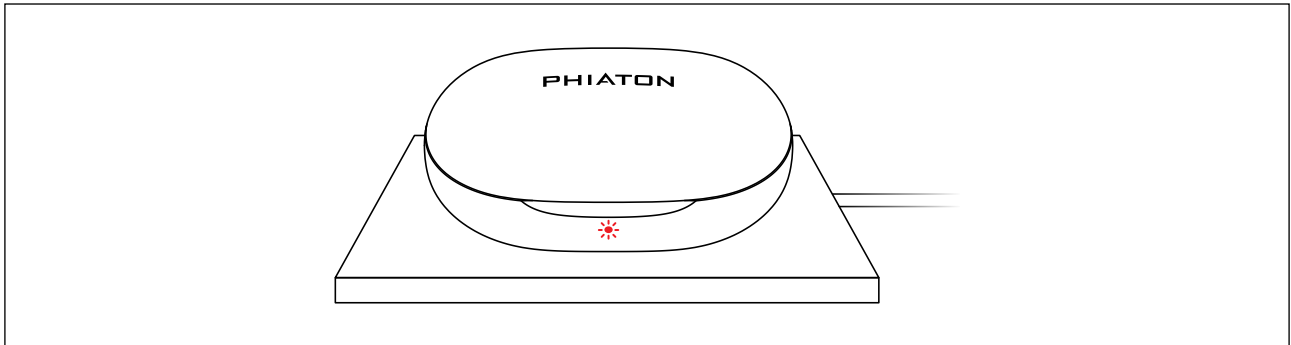

4-3. Checking Battery Level

1) Check the earbuds battery level

When the battery level is less than 10%, the earbuds red LED blinks twice every 5 seconds.

When the remaining battery power is low, voice guidance is provided every 5 minutes.

'Battery is low'

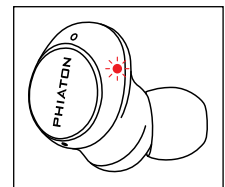

2) Check the case battery level

When you open the case, you can check the charge level through the 'Case Charge Status LED'.

- ※ The red LED means the earbuds can't be fully charged using the remaining battery of the case.
- ※ The white LED means the earbuds can be fully charged more than once using the remaining battery of the case.
- ※ When the case battery is below 5%, the red LED blinks twice.

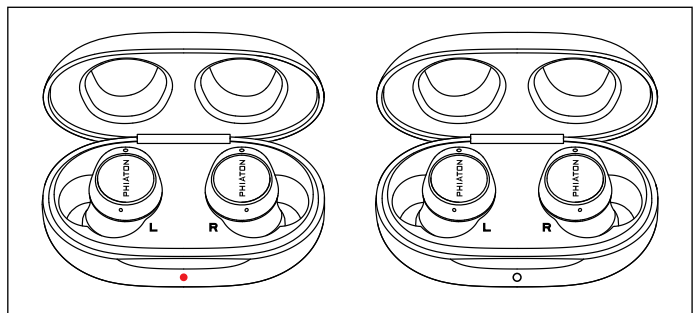

5. Power ON/OFF

1) Turning on the earbuds

- ① When you take the earbuds out of the case, the earbuds turn on automatically.
- ② If you're pairing BonoBuds Plus for the first time or previously paired device is not nearby, it enters 'paring mode' after 5 seconds.
- ③ If a 'device with connection history' is nearby, the earbuds will be connected immediately when you take them out of the case.
 - ※ When in pairing mode, the earbuds will turn off after 3 minutes if it hasn't established a Bluetooth connection.

2) Turning off the earbuds

When you put the earbuds in the 'case', the earbuds automatically turn off.

- ※ You can turn on/off the earbuds only when there is remaining battery power in the case.

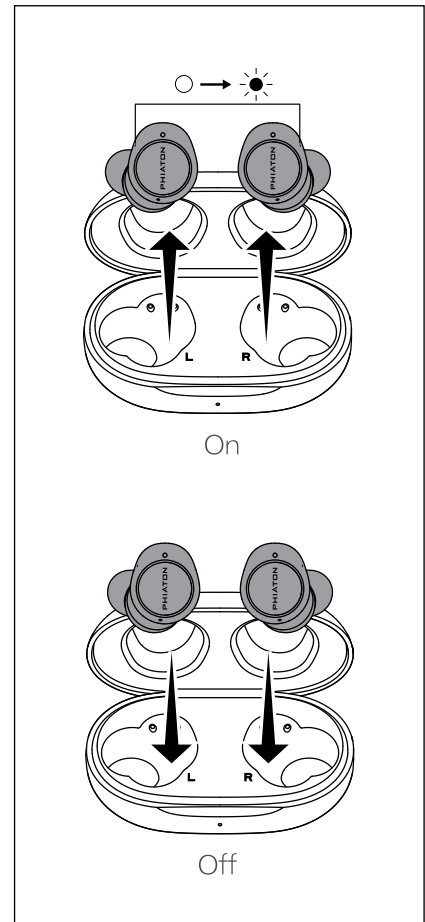

6. Connecting/pairing with other Bluetooth devices

- ① With the earbuds in the case, simultaneously press the touch parts of both earbuds for 8 seconds.
 - ※ When the white LED of the earbuds lights up twice, the product is in default setting.
- ② When earbuds is taken out of the case, the earbuds are automatically turned on and ready for pairing after 5 seconds.
- ③ From the 'Bluetooth Settings' of the device to be connected with BonoBuds Plus, select 'PHIATON BonoBuds Plus' to complete pairing.
- ④ When the earbuds are connected to the device, voice guidance is provided. 'Device connected'

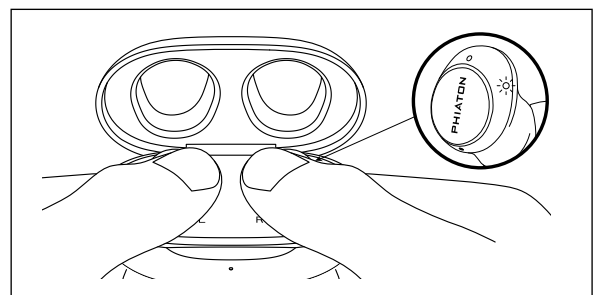

Pairing

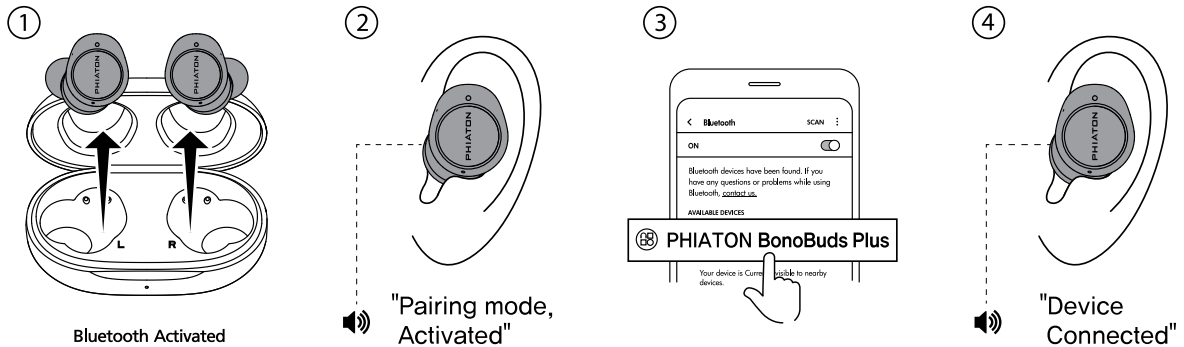

Manual pairing

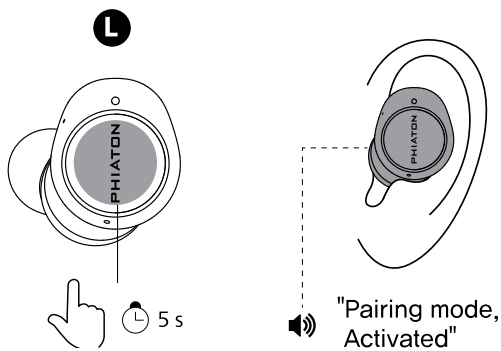

7. Managing Music (play & control)

You can control the 'music function' of the connected Bluetooth device by pressing the touch controls of the left and right earbuds.

1) Play/stop music

- 1 Tap the earbuds to play music from the Bluetooth device.
- 2 Tap the earbuds to stop the song if it's playing.

2) How to use the change song function

- 1 Double-tap the earbuds to skip to the next song.
- 2 Triple-tap the earbuds to go back to the previous song.

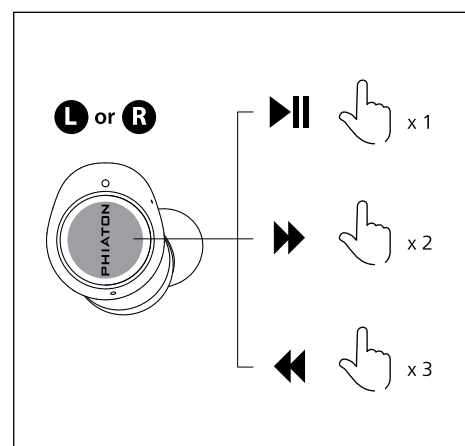

8. Call Function

If you receive a call while using, tap the earbuds to answer and end the call.

1) Answering a call

Tap earbud twice to accept / end a call.

2) Ending a call

When the call is over, double-tap the earbuds to end the call.
(In the case of a call received while listening to music, the music will automatically pause and will play again when the call ends.)

- ※ When connecting to a call, the audio will come out of the earbuds.
- ※ Functions may vary depending on the paired Bluetooth device.
- ※ When you click/touch on the connected device to answer a call the call will connect to the device.

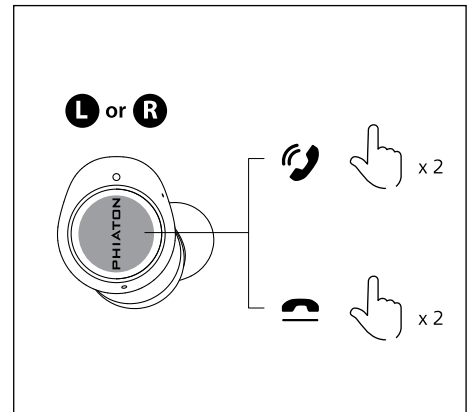

9. Noise Cancelling Function

1) What is 'Noise Cancelling'?

Noise Cancelling refers to a technology that reduces noise from mid/low pitched sounds under 1 kHz.

2) Turning Noise Cancelling

When both earbuds L/R are removed from the case and then the earbuds are worn, the noise cancelling function is activated automatically.

- ※ When wearing one earbud, the noise cancelling function does not work.

10. Ambient Mode (Audio Transparency)

- ① Ambient Mode is a function that allows you to hear ambient sounds without removing the earbuds from your ears while the noise cancelling function is in operation.
- ② If you press and hold the touch part of the right earbud for 2 seconds, the noise cancelling function stops and you can listen to external sounds. At this time, you will be guided by voice, 'Ambient Mode'
- ③ If you press and hold the touch part of the right earbud for 2 seconds again, the external sound listening function is stopped and the noise cancelling function is activated again. At this time, you will be guided by voice, 'Noise Cancelling On'

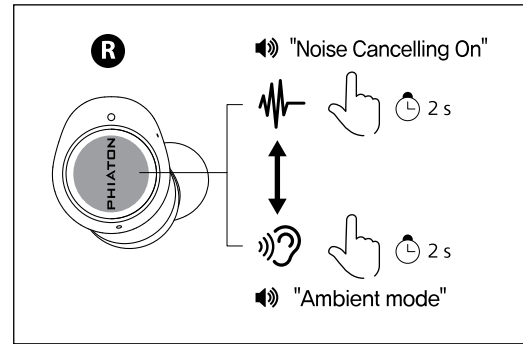

11. Activate the voice command function

Activate the voice command function of the connected Bluetooth device by tapping the earbuds

Press and hold the touch control of the left earbud for 2 seconds. After you hear a beep, release your hand to give voice commands.

※ Functions may vary depending on the paired Bluetooth device.

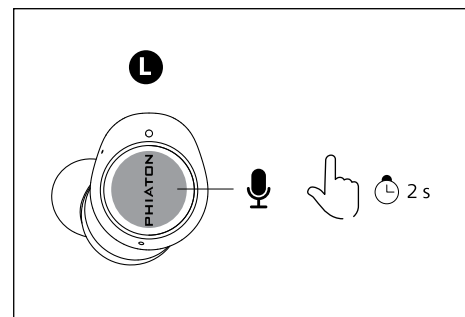

12. Product Reset

If an unknown problem occurs, most issues can be resolved by simply resetting the device.

- ① With the earbuds in the case, simultaneously press the touch parts of both earbuds for 8 seconds.

※ When the white LED of the earbuds lights up twice, the product is in default setting.

- ② When earbuds is taken out of the case, the earbuds are automatically turned on and ready for pairing.

- ③ Select 'PHIATON BonoBuds Plus' from the 'Bluetooth Settings' of the device to be connected with the earbuds.

- ④ When the earbuds are connected to the device, voice guidance is provided. 'Device connected'

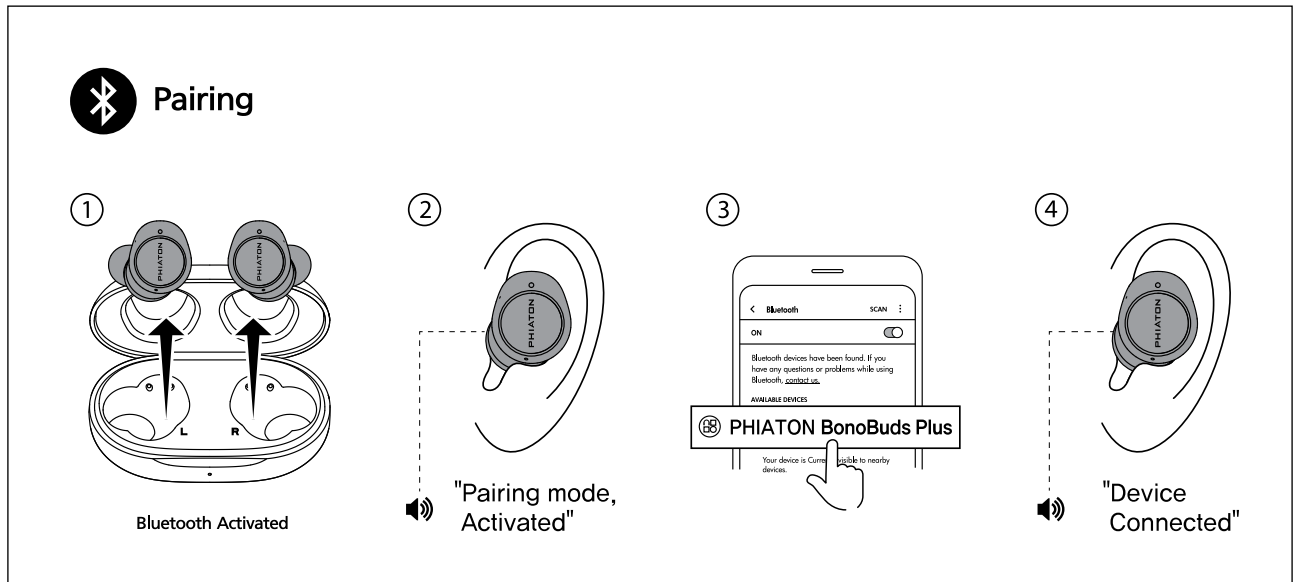
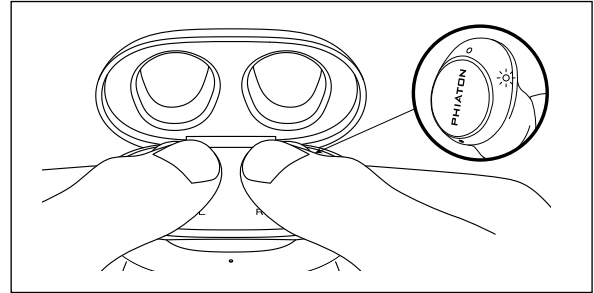

※ All existing connection history will be reset.

13. Specifications

Communication Network	Bluetooth Version 5.2
Bluetooth Profiles	A2DP 1.3.2, HFP 1.8, HSP 1.2, AVRCP 1.6.2
Audio Codec	SBC, AAC, Qualcomm® aptX™ Adaptive
Operating Frequencies	2.4GHz(2.402~2.480GHz)
Operating Range	Within 10m
Music Play	NC On 6 hrs
Full Charge Time	Earbuds : 1hrs / Charging Case : 1.8hrs
Earbuds Dimensions (L x W x H)	24.2 x 23.6 x 26.9mm / 0.95 x 0.93 x 1.06 inch
Charging case Dimensions (L x W x H)	70.7 x 38.8 x 32.7mm / 2.79 x 1.53 x 1.29 inch
Weight	Earbuds: 5.3g (0.012lb) / Charging Case: 38.4g (0.085lb)
Driver Unit	Ø12.0
Sensitivity	105 dB

※ The specifications are subject to change without prior notice for quality improvement.

14. Troubleshooting

1) The power does not turn on:

- Make sure the earbud protection film has been removed.
- Charge the device for at least 30 minutes.
- If the power does not turn on even after charging, contact PHIATON Customer Service.

2) The device does not charge:

- Make sure the earbud protection film has been removed.
- Check whether the USB charging cable has been properly connected with the device.
- Check whether the PC power is on and that it has been properly connected.
- When using a separately purchased USB AC adaptor, check to see that it has been properly connected.

3) The device does not pair:

- Check whether the power of the Bluetooth device you want to connect is on.
- Check whether the Bluetooth feature within the Bluetooth device you want to connect is enabled.

– Check whether the Bluetooth device you want to connect is within the supported range.

(Pairing is supported only within 3 feet)

– Check whether the Bluetooth profile within the Bluetooth device is compatible.

4) When there is no sound or music:

– Check whether the power of the device and the Bluetooth device is on.

– Check whether music is being played within the connected Bluetooth device.

– Check whether the volume within the connected Bluetooth device is low.

5) When there is static noise or the sound cuts off:

– Check whether there is another electronic device nearby using the 2.4 GHz frequency band that is connected to the Bluetooth device.

– Check whether the connected Bluetooth device is within the proper communication distance to the device. (Maximum communication range: 33 feet)

6) The other party cannot be heard while on a call:

– Check if the power of the Bluetooth device you want to connect is on.

– Check whether the volume within the connected Bluetooth device is low.

7) When noise cancelling or ambient mode does not work:

– Please check if all earbuds L/R work by putting them in the case and taking them out again.

– When wearing one earbud, the noise cancelling function does not work.

8) Product does not operate or operation has stopped:

– Please check if all earbuds L/R work by putting them in the case and taking them out again.

– If any of the above methods do not work, please reset the earbuds.

9) The device is paired with a PC/Laptop but does not work:

– PC/Laptops are equipped with various Bluetooth drivers depending on the manufacturer.

It is possible that the PC/Laptop you are trying to connect is not compatible with 'PHIATON BonoBuds Plus'

15. Certification

FCC Compliance Information

FCC ID: V2R-TN0620

This device complies with Part 15 of the FCC Rules.

Operation is subject to the following two conditions:

- (1) this device may not cause harmful interference, and
- (2) this device must accept any interference received, including interference that may cause undesired operation.

Warning: Changes or modifications not expressly approved by the party responsible for compliance could void the user's authority to operate the equipment

NOTE :

This equipment has been tested and found to comply with the limits for a Class B Digital Device, pursuant to Part 15 of the FCC Rules. These limits are designed to provide reasonable protection against harmful interference in a residential installation. This equipment generates, uses and can radiate radio frequency energy and, if not installed and used in accordance with the instruction, may cause harmful interference to radio communication. However, there is no guarantee that interference will not occur in a particular installation. If this equipment does cause harmful interference to radio or television reception. Which can be determined by turning the equipment off and on, the user is encouraged to try to correct the interference by one or more of the following measures :

- Reorient or relocate the receiving antenna.
- Increase the separation between the equipment and receiver
- Connect the equipment into an outlet on a circuit different from that to which the receiver is connected.
- Consult the dealer or an experienced radio/TV technician for help.

This equipment complies with FCC radiation exposure limits set forth for an uncontrolled environment and meets the FCC radio frequency (RF) Exposure Guidelines.

This equipment has very low levels of RF energy that is deemed to comply without testing of specific absorption rate (SAR).

Caution:

Changes or modifications not expressly approved by the party responsible for compliance could void the user's authority to operate the equipment.

IC Compliance Information

IC ID: 10488A-TN0620

This device complies with Industry Canada's license-exempt RSS(s).

Operation is subject to the following two conditions:

- (1) This device may not cause interference.
- (2) This device must accept any interference, including interference that may cause undesired operation of the device.

This equipment complies with IC radiation exposure limits set forth for an uncontrolled environment and meets RSS-102 of the IC radio frequency (RF) Exposure rules.

Pour la clientèle au Canada

L'émetteur/récepteur exempt de licence contenu dans le présent appareil est conforme aux CNR d'Innovation, Sciences et Développement économique Canada applicables aux appareils radio exempts de licence. L'exploitation est autorisée aux deux conditions suivantes :

(1) L'appareil ne doit pas produire de brouillage;

(2) L'appareil doit accepter tout brouillage radioélectrique subi, même si le brouillage est susceptible d'en compromettre le fonctionnement.

TN0620 a été testé et jugé conforme aux limites d'exposition aux rayonnements énoncées pour un environnement non contrôlé et respecte les règles d'exposition aux fréquences radioélectriques (RF) CNR-102 de l'ISDE.

CE Compliance Information

Hereby, PHIATON declares that this product is in compliance with the essential requirements and other relevant provisions of RE Directive 2014/53/EU
2011/65/EU.

Responsible Party-U.S. Contact Information

PHIATON Corporation

10231 Slater Ave., #211, Fountain Valley, CA 92708, USA

To learn more, visit our website, www.phiaton.com

Phiaton is a trademark of Phiaton Corporation