

# User Manual



## Newtron Booster



# Contents

---

<b>1 Documentation</b>	<b>5</b>
1.1 Associated documentation	5
1.2 Electronic documentation	5
<b>2 Required information</b>	<b>7</b>
2.1 Indication for use	7
2.2 Operating principle	7
2.3 Date of inclusion of EC marking	7
2.4 Latest document update	7
2.5 Repairing or modifying the device	7
2.6 Accessory usage conditions	7
<b>3 Removal from packaging, installation, connections</b>	<b>9</b>
3.1 Unpacking your medical device	9
3.2 Positioning the medical device	9
3.3 Installing cords	9
3.4 Connecting the medical device to the water system	9
3.5 Connecting the medical device to the electrical network	10
3.6 Plugging the medical device to the electrical network	10
3.7 Installing the control pedal	10
<b>4 Description of the medical device</b>	<b>11</b>
4.1 Control unit	11
4.2 Power configuration button	11
4.3 Adjusting ultrasound power	11
4.4 SLIM handpiece	11
4.5 Attach a tip or a file	11
4.6 Connecting and disconnecting accessories during use	11
4.7 Connecting the handpiece	11
4.8 Handpiece support	12
4.9 The cord	12
4.10 Light indicator	12
4.11 Irrigation flow configuration button	12
4.12 Adjusting the irrigation	12
4.13 Initiating irrigation	12
4.14 Air inlets	12
4.15 Connection to water system	12
4.16 Control pedal	12
4.17 Activating ultrasounds using the pedal	13
4.18 Electrical Adapter	13
4.19 Cleaning the irrigation system	13
<b>5 Cleaning, disinfecting and sterilizing</b>	<b>15</b>
5.1 Cleaning and disinfection of the medical device	15

---

5.2 Cleaning and disinfecting accessories .....	16
<b>6 Monitoring and maintenance of the medical device .....</b>	<b>17</b>
<b>7 Maintenance .....</b>	<b>19</b>
7.1 Replacing the water filter .....	19
7.2 Identifying incorrect operation .....	19
7.2.1 No operation .....	19
7.2.2 No spray .....	19
7.2.3 The power is not as expected .....	20
7.2.4 Ultrasounds not working .....	20
7.2.5 Water leakage .....	20
<b>8 Technical specifications for the medical device .....</b>	<b>21</b>
8.1 Identification .....	21
8.2 Mains Adapter .....	21
8.3 Control unit .....	21
8.4 Ultrasonic generator .....	21
8.5 Length of cords .....	22
8.6 Irrigation .....	22
8.7 Control pedal .....	22
8.8 Environmental characteristics .....	22
8.9 Environmental restrictions .....	22
8.10 Main performance characteristics .....	22
<b>9 Regulations and standards .....</b>	<b>23</b>
9.1 Official Texts .....	23
9.2 Medical class of the device .....	23
9.3 Standardised Symbols .....	24
9.4 Manufacturer identification .....	25
9.5 Branch addresses .....	26
9.6 Disposal and recycling .....	28
<b>10 Index .....</b>	<b>29</b>

# Foreword

The medical device SATELEC<sup>®</sup> that you are about to install and use in your practice is a medical device designed for professional use. It comprises the chosen tool with which you will provide treatment within the context of your work.

To ensure optimum safety for yourself and your patients, comfort in your daily practice and to benefit fully from the technology of your medical device, please read the documentation provided carefully.

If you have received this medical device by mistake, please contact the supplier to arrange for it to be collected.

Please refer to the general instructions relating to the comprehensive range of dental ultrasonic generators by SATELEC<sup>®</sup> for information about the following:

- documentation format;
- the documentation archiving period;
- warnings concerning user population;
- the treatment area;
- the medical device usage interactions, contraindications and prohibitions;
- electromagnetic compatibility;
- disposal and recycling of the medical device;
- manufacturer responsibility.

Please refer to the accessory cleaning, disinfection and sterilization protocols and the handpiece pre-disinfection, cleaning and sterilisation protocols for information about the following:

- preparation of parts for sterilization;
- detailed manual and automatic protocols;
- information concerning the sterilization;
- recommendations for the inspection of parts.



# 1 Documentation

This document contains the following information:

- indications for use;
- description of the medical device;
- installation of the medical device;
- use of the medical device;
- preparation for cleaning and disinfection of the medical device;
- monitoring and general maintenance of the medical device;
- maintenance to be performed by the user.

## 1.1 Associated documentation

This document must be used in association with the following documents:

Document title	References
Cleaning, disinfection and sterilization protocols for Wrenches SATELEC <sup>®</sup>	J81009
Cleaning, disinfection and sterilization protocols for Tips SATELEC <sup>®</sup>	J02009
Cleaning, disinfection and sterilization protocols for Handpieces SATELEC <sup>®</sup>	J12919
General instructions relating to the complete range of SATELEC <sup>®</sup> dental ultrasonic generators	J00019
Method for consulting electronic user instructions	J00000
Quick Clean Newtron <sup>®</sup> Booster	J60101
Quick Start Newtron <sup>®</sup> Booster	J60100
User Manual for Newtron <sup>®</sup> Booster	J60119

## 1.2 Electronic documentation

The user instructions for your device are provided in electronic format and not in printed format. However, you can request a free printed copy of the user instructions within 7 days via our website, by telephone or in writing.

The electronic user instructions are available in PDF format (Portable Document Format) and you will need to have a PDF file read software installed to read the instructions.

The device user instructions can be consulted at the following address:

[www.satelec.com/documents](http://www.satelec.com/documents)

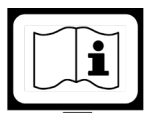

Electronic user  
informations



It is important for you to have read and understood the content of the user instructions relating to the use of your device and its accessories prior to use.

We recommend that you visit the website regularly to consult and/or to download the latest version of your device's user instructions.





# 2 Required information

## 2.1 Indication for use

This medical device is used in association with a dental ultrasound handpiece to which an ultrasound instrument is attached. It is intended for prophylaxis, including scaling, for periodontics, for endodontics, and for preservation and restoration dentistry, including prosthesis.

## 2.2 Operating principle

An electrical signal emitted by the medical device is supplied to the dental ultrasonic handpiece. This is connected to the medical device via a cord. The handpiece comprises a piezoelectric ceramic transducer, which transforms the electrical signal into ultrasonic vibrations. Mechanical vibrations are transmitted to a tip or a dental file attached to the end of the ultrasonic handpiece.

## 2.3 Date of inclusion of EC marking

2013

## 2.4 Latest document update

11/2013

## 2.5 Repairing or modifying the device

Contact the supplier of your device. Using the services of an unapproved repairer could render your device dangerous for you and your patients.

Do not repair or modify the medical device without seeking the prior permission of SATELEC®.

If the device is modified or repaired, specific checks and tests must be carried out to ensure that the device is still safe to use.

In the event of doubt, contact an approved dealer or the SATELEC® customer service team :

[www.acteongroup.com](http://www.acteongroup.com)

[satelec@acteongroup.com](mailto:satelec@acteongroup.com)

SATELEC® at the request of technical personnel working for the network of dealers approved by SATELEC®, provides all information required to repair the faulty parts on which they may perform repairs.

## 2.6 Accessory usage conditions

Accessories and must be cleaned, disinfected and sterilized prior to use.



# 3 Removal from packaging, installation, connections

## 3.1 Unpacking your medical device

When you receive your medical device, check for any damage that may have occurred during transportation. If you have received this medical device by mistake, please contact the supplier to arrange for it to be collected.

If you have any questions or requirements, contact your supplier.

The Newtron<sup>®</sup> Booster includes the following items:

- a Newtron<sup>®</sup> Booster unit with non-detachable pedal cord, a non-detachable SLIM cord and a SLIM handpiece support;
- a Newtron<sup>®</sup> SLIM handpiece, a Quick Start [J12900] and a Quick Clean [J12930];
- tips and wrenches depending on selected options;
- a mains adapter and its cord;
- a Quick Start Newtron<sup>®</sup> Booster [J60100];
- a Quick Clean Newtron<sup>®</sup> Booster [J60101].

## 3.2 Positioning the medical device

Place the control unit in the position that is suitable for your activity.

Check that the cords do not hinder the movement or free circulation of anyone.

The medical device must be placed on a secure and flat surface or a surface with a maximum slope of 5 degrees.

Fix your medical device using the attachments provided to ensure that the device cannot be removed without the use of a tool.

Adjust the position of your medical device to correspond to your angle of vision and the characteristics of your workstation, e.g. lighting or distance between the user and the medical device.

Ensure that you can access your medical device quickly.

| Do not install your medical device near or on another device.

## 3.3 Installing cords

Check that the cords do not hinder the movement or free circulation of anyone.

Never rotate the handpiece connector on its cord as this can damage your medical device.

Never wrap the handpiece cord around the medical device.

Make sure that it is not possible to wheel over or walk on the different cords.

The cord attached to its must be easily accessible. Make sure that the cord is slack during use.

| Do not put the medical device cords in a cable cover or a cable tray.

## 3.4 Connecting the medical device to the water system

| The information below only applies to a medical device that needs to be connected to the water system to operate.

Ask an approved dental installation technician to connect your medical device to the water system.

The water supply system pressure may vary throughout the day. The water supply system pressure must be adapted to the values recommended for your medical device. It is very important to make sure that the maximum pressure permitted for the medical device is never reached or exceeded. If in doubt, you are strongly advised to install or arrange for installation of a water pressure limiting system.

The water supply system must comply with the quality criteria compatible with the practice of dental treatments.

### 3.5 Connecting the medical device to the electrical network

Set the medical device to OFF position 0 and check that the mains voltage is compatible with that indicated on the medical device or its mains adapter. Next, connect the cord to the wall socket in compliance with the standards in force in the country of use.

A different voltage would cause damage to the medical device and could injure the patient and/or user. Any variation in the electrical network voltage or electromagnetic field that is non-compliant with the limits in force, could interfere with the medical device's operation.

The medical devices equipped with a protective earth must be connected to a supply network equipped with a protective earth.

Do not plug the medical device into an extension lead and do not put the mains cord in a cable cover or cable tray.

### 3.6 Plugging the medical device to the electrical network

1. Move the power configuration button to position 0;
2. connect the mains adapter to the medical device connector;
3. connect the mains adapter cord to the mains adapter;
4. connect the mains adapter cord to the electrical fixture wall socket.

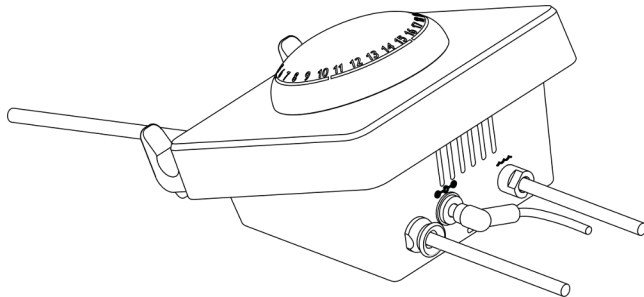

### 3.7 Installing the control pedal

The control pedal must be positioned near the feet of the operator and must be readily accessible.

# 4 Description of the medical device

## 4.1 Control unit

The control unit incorporates technology Newtron<sup>®</sup> patented by SATELEC<sup>®</sup>.

The patented technology Newtron<sup>®</sup> controls the tips by Cruise Control<sup>®</sup>, an automatic system for setting the frequency and power in real time. This ensures that Satelec<sup>®</sup> tip vibration is gentle, regular and controlled.

## 4.2 Power configuration button

To ensure a quality treatment, you will need to use the tips at the power and irrigation flow settings recommended by SATELEC<sup>®</sup>.

The ultrasound power configuration button ensures:

- Switching On/Switching off of the device (OI symbol).
- Configuration of the operating power: 1 to 20.

The configuration button has 4 colour sectors, each with 5 positions.

- Green: 1 to 6: very low to low power, used mainly for periodontics.
- Yellow: 6 to 11: medium power, used mainly for endodontics.
- Blue: 11 to 16: high power, used mainly for scale removal.
- Orange: 16 to 20: very high power, used mainly for implant loosening.

The ultrasound power configuration button is not designed to be removed.

## 4.3 Adjusting ultrasound power

Adjust the ultrasound power using the ultrasound power configuration button. The ultrasound power must be adjusted in accordance with the tip used and the required treatment. The operating power of the tips must be selected in compliance with the Satelec tips color coding system (CCS tips). Details of these indications are given in the adjustment table available at the address [www.satelec.com/documents](http://www.satelec.com/documents) and on the treatment sheets.

## 4.4 SLIM handpiece

Only handpieces with SLIM connector SATELEC<sup>®</sup> can be connected to the medical device. The medical device must be used with a SLIM handpiece Newtron<sup>®</sup>. Refer to the Newtron<sup>®</sup> handpiece user manual [J12921] for more information.

## 4.5 Attach a tip or a file

A tip or a file vibrates correctly when it is perfectly tightened without being forced beyond its stop point. Tighten it moderately using the wrench provided to ensure optimum ultrasound operation. Over-tightening of the tip or file can result in breakage of the tip, file or .

| To prevent self-locking of the tip or the file, the latter must be removed after each use.

## 4.6 Connecting and disconnecting accessories during use

| Do not connect/disconnect the cord(s) or the handpiece when the medical device is switched on and your foot is on the pedal.

| Do not tighten or loosen the tips when the handpiece is activated.

## 4.7 Connecting the handpiece

Check for the absence of signs of humidity at the connections, and eliminate them if necessary (wipe and blow using a multipurpose syringe).

Lubricate the irrigation system seal located behind the with dental instrument lubricant such as ClearView™ Dental Handpiece Lubricant manufactured by Dental Air Solutions to extend its effectiveness and prevent leaks.

Connect the to the sleeve, by aligning the indexing points and by avoiding rotation movement.  
Install the on the support.

## 4.8 Handpiece support

The support holds the handpiece or the handpiece connector.

The two silicone supports can be removed by sliding them along the metal rod.

## 4.9 The cord

The SLIM cord is only compatible with handpieces SATELEC® with SLIM connector.

The SLIM cord ensures irrigation circulation and electrical connection between the medical device and the .

## 4.10 Light indicator

The light indicator is designed to provide information about the status of the device.

When the light indicator is illuminated, the medical device is on and ready to use.

## 4.11 Irrigation flow configuration button

The irrigation flow configuration button stops the irrigation function at the stop at least and sets the irrigation flow: from "min" to "max".

The irrigation flow configuration button is not designed to be removed.

## 4.12 Adjusting the irrigation

Adjust the irrigation flow using the irrigation flow configuration button. This adjustment depends on the tip and the treatment.

As work habits, feedback and professional training differ from one professional to another, the user must make sure that the irrigation flow is perfectly adapted to the treatment to be carried out to avoid burning the treatment area.

## 4.13 Initiating irrigation

The medical device must be set to minimum power depending on the required irrigation flow rate. Press the pedal until a spray appears.

## 4.14 Air inlets

Air inlets ensure correct ventilation of the control unit. Leave them uncovered to allow air to circulate.

## 4.15 Connection to water system

The supply pipe connector is used to connect the medical device device to the domestic water distribution system. The connector is extended by a pipe to which a filter is attached. The filter needs to be cleaned and/or replaced regularly as specified in the chapter *Replacing the water filter page 19*.

| The water quality must meet the criteria required to perform dental treatments.

## 4.16 Control pedal

The ON/OFF type pedal is used by the practitioner to operate the medical device.

Pressing the pedal automatically activates the handpiece ultrasounds, and the irrigation function if it is not in 0 position.

The control pedal equipped with its cord cannot be disconnected. Its weight and antislip pad ensure good stability.

## 4.17 Activating ultrasounds using the pedal

To activate the ultrasounds on your medical device, press the control pedal.

## 4.18 Electrical Adapter

The medical device is designed to be connected to a mains adapter, which is considered as being an integral part of the medical device. The mains adapter helps to make the medical device electrically safe. The medical device's mains adapter serves as a disconnecting device, the socket outlet must be installed near the medical device and must be easily accessible.

The mains cord connects the mains adapter to the control unit.

| Only use the mains adapter supplied with your medical device.

## 4.19 Cleaning the irrigation system

After installation and before first use, at the end of the day and following a period of prolonged non-use of the medical device, it is important to clean the irrigation system.

Operate the device at minimum power, at maximum irrigation flow rate for two minutes.

When the irrigation system has been cleaned, perform the following operations:

1. disconnect the handpiece and refer to handpiece pre-disinfection, cleaning and sterilisation protocols SATELEC® [J12919];
2. clean and disinfect the medical device as indicated in the chapter *Cleaning and disinfection of the medical device page 15*
3. follow the instructions for accessory cleaning, disinfection and sterilization protocols SATELEC® [J81009] and [J02009].





# 5 Cleaning, disinfecting and sterilizing

The instructions relating to accessory cleaning, disinfection and sterilization protocols provided by SATELEC® have been approved for each medical device and accessory. The applicable guides are listed in chapter *Associated documentation page 5*

They can be downloaded at the following address:

[www.satelec.com/documents](http://www.satelec.com/documents)

In all cases, the local regulations in force relating to the accessory cleaning, disinfection and sterilization protocols take precedence over the information provided by SATELEC®.

## 5.1 Cleaning and disinfection of the medical device

The medical device must be in OFF or O stop position during cleaning and disinfecting procedures.

Refer to the instructions detailed in the chapter *Cleaning the irrigation system page 13*

Avoid using cleaning and disinfection products that contain flammable agents.

Otherwise, ensure that the product has completely evaporated from or that there is not fuel left on the medical device and its accessories before switching it on.

- | Do not use abrasive product to clean the medical device.

- | Never apply sprays directly to the medical device to clean it. Always spray the product onto a wipe, then clean the medical device.

The medical device control unit, handpiece cord and control pedal must be cleaned and disinfected daily.

The wipes Unowipes manufactured by Medcart International Ltd may be used to clean and sterilise the medical device.

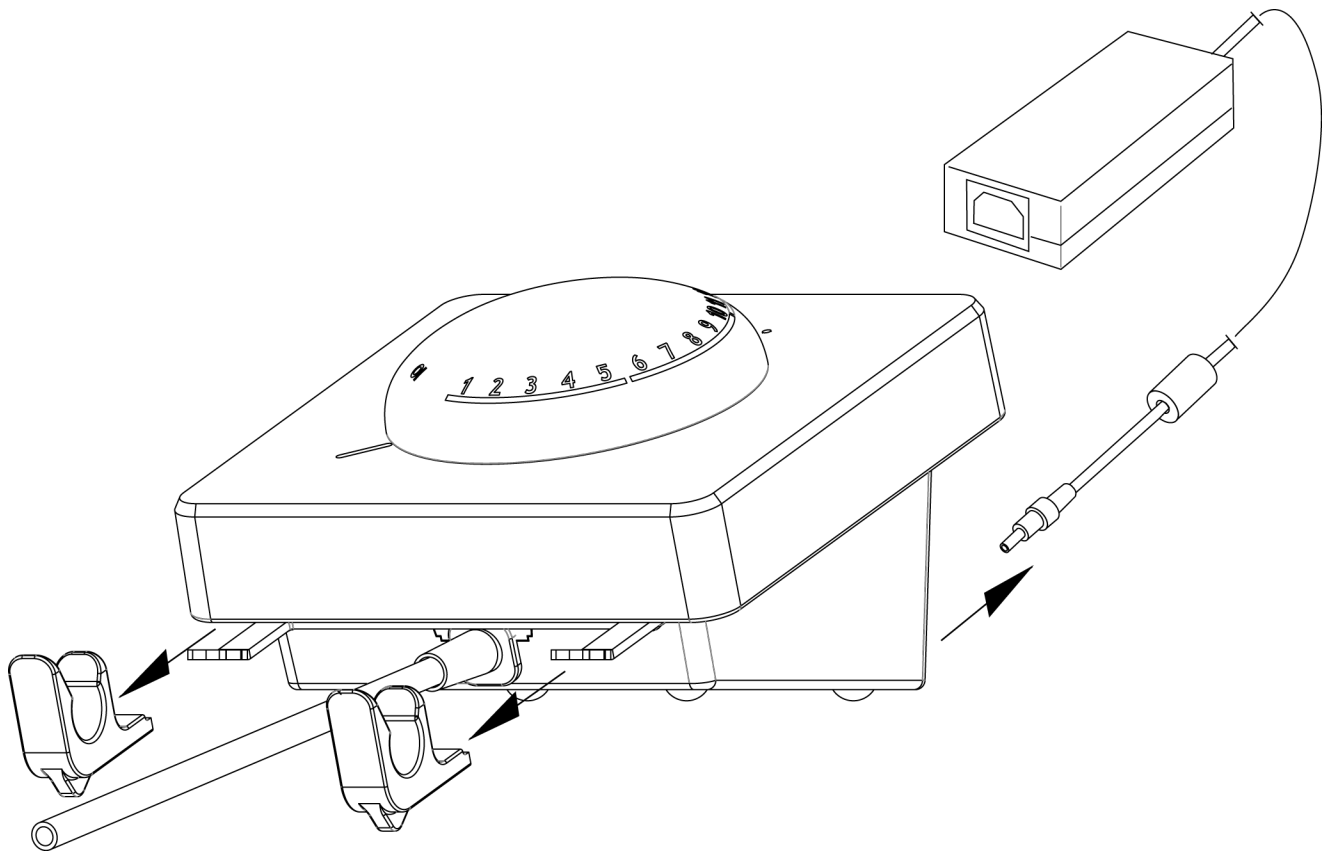

To prepare for cleaning, remove the various parts of Newtron<sup>®</sup> Booster as shown here.

## 5.2 Cleaning and disinfecting accessories

Refer to the accessory cleaning, disinfection and sterilization protocols listed in the chapter *Associated documentation page 5*.

The diamond coated inserts cannot be reprocessed since they cannot be cleaned properly. Bone and soil residues might remain adhered to the diamond coating even after cleaning and sterilization and enter into the oral cavity of another patient.

# 6 Monitoring and maintenance of the medical device

Before and after each use, check that the device and its accessories are not faulty in any way. This is necessary to detect any isolation fault or damage. If necessary, replace damaged parts.

Monitor the cleanliness of the air inlets on the control unit to prevent any heating.



# 7 Maintenance

The only preventive maintenance the medical device requires is:

- checking of accessories;
- everyday cleaning, disinfection and sterilisation procedures;
- cleaning ;
- replacement of the water filter cartridge.

## 7.1 Replacing the water filter

The water filter must be cleaned regularly and must be replaced every 6 months.

Proceed as follows:

- shut off the water supply;
- stop the medical device (position O);
- unplug the network plug;
- unscrew the two filter sections;
- using the two 10 mm open-ended wrenches, remove the filter cartridge to be replaced [kit F10389] or clean it with water spray;
- repeat the same process for the seal;
- perform the same operations in the reverse order for reassembly;
- check that the spray works correctly and that there is no leakage.

| A damaged or blocked cartridge must be replaced.

## 7.2 Identifying incorrect operation

In the event of incorrect operation, refer to the tables below to quickly identify and repair the non-complex parts of the medical device.

If the incorrect operation is not described in the tables below, please contact your supplier or the After-Sales team at SATELEC®.

Do not use the medical device if it appears to be damaged or faulty. Isolate the medical device and make sure that it cannot be used.

### 7.2.1 No operation

Symptoms: the indicator light on the mains adapter is off, the indicator light on the medical device is off and the medical device is not working.

Possible causes	Solutions
Faulty connection between the mains cord and the mains adapter	Connect the mains cord to the mains adapter
Faulty connection between the control unit and the mains adapter	Connect the mains adapter to the control unit
No electrical current	Contact your electrician
Power configuration button in position O	Set the power configuration button to I
Internal fuse not working	Return to After-Sales team SATELEC®
Mains switch in position O	Set the mains switch to position I

| The medical device also has an internal fuse (ref. F1 on the printed circuit board) that cannot be accessed by the user.

### 7.2.2 No spray

Symptoms: There is no water spray at the tip.

Possible causes	Solutions
Dental cabinet water inlet in shut-off position	Open the water inlet
Flow configuration button on minimum	Adjust the flow configuration button
Faulty water pipe connection	Check the water inlet
Low water pressure	Check the water system pressure
Blocked filter	Clean or change the filter
Faulty solenoid valve	Return to After-Sales Department SATELEC®
Tip or file blocked	Unblock the tip or file
Incorrect choice of tip	Check the tip
Inadequate amount of spray	Adjust the spray

### 7.2.3 The power is not as expected

Symptoms: the tip does not vibrate at the expected frequency, the treatment is not progressing as normal and is taking longer or at is at a standstill.

Possible causes	Solutions
Worn or distorted tip	Replace the tip
Incorrect use: incorrect approach angle or inadequate pressure on the tooth	Refer to the configuration table available at <a href="http://www.satelec.com/documents">www.satelec.com/documents</a>
Presence of liquid or humidity between the handpiece and cord	Thoroughly dry the electrical contacts

### 7.2.4 Ultrasounds not working

Symptoms: the tip does not vibrate, vibration cannot be heard.

Possible causes	Solutions
Tip loose	Tighten the tip using the wrench
Faulty connector contact	Clean the cord contacts
Handpiece cord wire(s) cut	Return to After-Sales Department SATELEC® to replace the cord

### 7.2.5 Water leakage

Symptoms: Water is leaking from one of the following places:

- between the base of the and its cord.

Possible causes	Solutions
Wear of 1.15 mm x1 mm seal	Replace the seal using F12304 kit. Refer to the instructions in document J12921

# 8 Technical specifications for the medical device

## 8.1 Identification

Manufacturer	SATELEC®
Name of the medical device	NEWTRON® BOOSTER

## 8.2 Mains Adapter

Manufacturer	CINCON ELECTRONICS CO.LTD
Model	TR60M36
Supply voltage	100 VAC - 240VAC
Power supply frequency	47Hz - 63Hz
Power consumption	60 W
Output voltage	36 VDC
Output current	1.66A
Width (in mm)	58
Height (in mm)	30.5
Depth (in mm)	132
Weight (in g)	1620 with mains cord

## 8.3 Control unit

Width (in mm)	130
Height (in mm)	88
Depth (in mm)	161
Weight (in g)	1 110 with
Ingress protection rating	IPX0

## 8.4 Ultrasonic generator

Supply voltage	36 VDC
Power consumption	25 W
Voltage supplied to handpiece	150 VAC
Output frequency	Minimum 28 kHz
Power setting range	1 to 20
Operating mode	Intermittent: 10 minutes ON / 5 minutes OFF
Type of leakage currents	BF
Electrical rating	2
Internal fuse not accessible to the user	Ref: F1 / 750 mA <sub>T</sub> - 125 V - SMD - Breaking capacity: 50 A

## 8.5 Length of cords

Scaler handpiece cord (in mm)	2 040
Control pedal cord (in mm)	2 000

## 8.6 Irrigation

Water pressure at inlet	1 to 5 bars
Maximum water output flow at the end of the handpiece	80 ml/min to 100 ml/min at 5 input bars

## 8.7 Control pedal

Width (in mm)	70
Height (in mm)	30
Depth (in mm)	95
Weight (in g)	150

Ingress protection rating: IPX1

## 8.8 Environmental characteristics

Operating temperature	+10 °C to +30 °C
Storage temperature	-0 °C to +60 °C
Operating humidity	30 % to 75 %
Storage humidity	10 % to 70 %, including condensation
Atmospheric pressure	Between 800 hPa and 1060 hPa
Altitude	Less than or equal to 2000 metres

## 8.9 Environmental restrictions

Usage premises	Can be used at all medical premises. The medical device must not be used in an operating theatre, or outside.
Use in gas-filled atmosphere	The medical device is not designed for use in a type AP or APG gas-filled atmosphere or in the presence of anaesthetic gases.
Immersion	The must not be immersed.

## 8.10 Main performance characteristics

Ultrasonic vibrations of the tip or file fitted to the end of the conventional dental ultrasonic handpiece.

- Vibration frequency  $\geq$  28 kHz.
- Tip amplitude  $\leq$  200  $\mu$ m.



# 9 Regulations and standards













## 9.1 Official Texts

This medical device complies with the essential requirements of European Directive 93/42/EEC. This equipment is designed and developed in compliance with Electrical Safety standard IEC60601-1 in force. It was designed and manufactured in accordance with an EN ISO 13485-certified quality assurance system.

## 9.2 Medical class of the device

This medical device is a class IIa device according to European Directive 93/42/EEC.

## 9.3 Standardised Symbols

Symbols	Meaning
	Refer to the accompanying documentation
	Consult the User Manual
 Electronic user informations	Accompanying documentation in electronic format
	BF type
	Class 2
	Alternating voltage
	Sterilisation at 132°C in an autoclave
	Washer disinfectant for thermal disinfection
	EC marking
	Do not dispose of as household waste
YYYY 	Year of manufacture
	Control pedal
0	Device OFF
I	Device ON
IPX1	<b>IP</b> : ingress protection ratings procured by a range <b>X</b> : no ingress of protection rating claim against the penetration of solids <b>1</b> : protects against the vertical falls of drops of water
Rx Only	Caution: US Federal law restricts this device to sale by or on the order of a Physician

## 9.4 Manufacturer identification

SATELEC

A Company of ACTEON Group

17, avenue Gustave Eiffel

BP 30216

33708 MERIGNAC cedex

FRANCE

Tel. +33 (0) 556.34.06.07

Fax. +33 (0) 556.34.92.92

E.mail: [satelec@acteongroup.com](mailto:satelec@acteongroup.com).

[www.acteongroup.com](http://www.acteongroup.com)

## 9.5 Branch addresses

### FRANCE

SATELEC ACTEON GROUP  
17 av. Gustave Eiffel  
Zone industrielle du phare - B.P. 30216  
33708 MERIGNAC cedex - France  
Tel. +33 (0) 556 34 06 07  
Fax. +33 (0) 556 34 92 92  
e-mail: satelec@acteongroup.com.

### U.S.A.

ACTEON Inc.  
124 Gaither Drive, Suite 140  
Mount Laurel, NJ 08054 - USA  
Tel. +1 856 222 9988  
Fax. +1 856 222 4726  
e-mail: info@us.acteongroup.com

### GERMANY

ACTEON GERMANY GmbH  
Industriestrasse 9 - 40822 METTMANN - GERMANY  
Tel. +49 21 04 95 65 10  
Fax. +49 21 04 95 65 11  
e-mail: info@de.acteongroup.com

### SPAIN

ACTEON MEDICO-DENTAL IBERICA, S.A.U.  
Avda Principal n° 11 H  
Poligono Industrial Can Clapers  
08181 SENTMENAT (BARCELONA) - SPAIN  
Tel. +34 93 715 45 20  
Fax. +34 93,715 32 29  
e-mail: info@es.acteongroup.com

### U.K.

ACTEON UK  
Unit 1B - Steel Close - Eaton Socon, St Neots  
CAMBS PE19 8TT - UK  
Tel. +44 1480 477 307  
Fax. +44 1480 477 381  
e-mail: info@uk.acteongroup.com

### MIDDLE EAST

ACTEON MIDDLE EAST  
Numan Center - 2nd Floor N° 205 - Gardens Street  
PO Box 5746 - 11953 AMMAN - JORDAN  
Tel. +962 6 553 4401  
Fax. +962 6 553 7833  
e-mail: info@me.acteongroup.com

### CHINA

### ACTEON CHINA

Office 401 - 12 Xinyuanxili Zhong Street -  
Chaoyang District - BEIJING 100027 - CHINA  
Tel. +86 10 646 570 11/2/3  
Fax. +86 10 646 580 15  
e-mail: beijing@cn.acteongroup.com

### THAILAND

ACTEON (THAILAND) LTD  
23/45 Sorachai Building 16th floor - Sukumvit 63  
Road, Klongton Nua - Wattana, BANGKOK 10110  
- THAILAND  
Tel. +66 2 714 3295  
Fax. +66 2 714 3296  
e-mail: info@th.acteongroup.com

### KOREA

ACTEON KOREA Corp.  
8F Hanil B/D - 132-4 1Ga Bongrae-dong -  
JOONG-GU - SEOUL - KOREA  
Tel. +82 2 753 41 91  
Fax. +82 2,753 41 93  
e-mail: info@kr.acteongroup.com

### INDIA

ACTEON INDIA  
B-94, GIDC Electronic Estate - Sector 25 -  
GANDHINAGAR 382028 Gujarat - INDIA  
Tel. +91 79 2328 7473  
Fax. +91 79 2328 7480  
e-mail: info@in.acteongroup.com

### LATIN AMERICA

ACTEON LATIN AMERICA  
Bogotá - COLOMBIA  
Celular: +57 312 377 8209  
e-mail : carlosandres.vera@es.acteongroup.com

### RUSSIA

ACTEON RUSSIA  
Valdajski Proezd 16 - office 253  
125445 Moscow - RUSSIA  
Tel./Fax. +7 499 76 71 316  
e-mail : sergey.koblov@ru.acteongroup.com

### AUSTRALIA/NEW ZEALAND

ACTEON AUSTRALIA/NEW ZEALAND  
Suite 119, 30-40 Harcourt Parade  
Rosebery NSW 2018  
Australia  
Tel. +612 9669 2292  
Fax. +612 9662 2204

e-mail : sandy.junior@au.acteongroup.com

**TAIWAN**

ACTEON TAIWAN

14F-1, N° 433, Jinping Rd.

Jhonghe Dist., New Taipei City 23563

TAIWAN (R.O.C)

Tel. + 886 926 704 505

e-mail : tina.chu@tw.acteongroup.com

## 9.6 Disposal and recycling

As an item of Electrical and Electronic Equipment, the medical device must be disposed of via a specialist collection, removal, recycling or destruction channel. This applies in particular to the European market, in reference to Directive 2002/96/EC dated 27/01/2003.

When your medical device has reached the end of its service life, contact your nearest dental equipment dealer, or ACTEON GROUP head office or one of the company branches to find out how to proceed. The relevant contact details are given in the chapter *Branch addresses page 26*.



# 10 Index

## A

After installation 13  
air circulation 12  
air inlets 12, 17  
Altitude 22  
Amplitude 22  
approved dealers 7  
attachments 9

## C

clean and disinfect the device 13  
clean irrigation system 13  
cleaned 7  
color coding system 11  
control pedal 10, 13  
control unit 11  
Cruise Control® 11

## D

damage 17  
dental file 7  
dental ultrasonic generators 5  
disinfected 7  
disposal 28

## E

Electrical Safety 23  
electronic user instructions 5  
end of the day 13  
endodontics 7  
European Directive 23

## F

fault 17  
Filter 20  
first inclusion of EC marking 7  
first use 13  
fuse 19

## G

gas-filled atmosphere 22  
general instructions relating to the comprehensive range of dental ultrasonic generators 3

## H

Handpieces 5, 11-12  
humidity 11

## I

incorrect operation 19  
indicator light 19  
irrigation flow 11-12

## K

kit F10389 19  
kit F12304 20

## L

light indicator 12  
Liquids 13

## M

mains adapter 10, 13

Mains switch 19  
Manufacturer 21  
Medical class 23

## N

non-use 13

## P

pedal 12  
periodontics 7  
power configuration button 10  
power settings 11  
preservation and restoration dentistry 7  
Pressure 22  
prophylaxis 7  
prosthesis 7

## Q

Quick Clean 5  
Quick Start 5

## R

Regulatory 5, 28  
repair 7

## S

scaling 7  
seal 20  
silicone supports 12  
SLIM cord 12  
spray 12, 19  
sterilized 7  
supply pipe 12

## T

Temperature 22  
tip 5, 7, 19-20  
treatment 11-12

## U

ultrasonic vibrations 7  
ultrasound power 11  
update 7  
user instructions 5  
User Manual 5

## V

Vibration frequency 22

## W

water filter 19  
water leak 20  
water system 9  
wipes 15  
Wrenches 5





Ref : J60119 • V3 • (13) • 11/2013 • NBABUS030C

---

A Company of ACTEON Group • 17 av. Gustave Eiffel • BP 30216 • 33708 MERIGNAC cedex • France  
Tel. +33 (0) 556 34 06 07 • Fax. +33 (0) 556 34 92 92  
E-mail: satelec@acteongroup.com • www.acteongroup.com

