

14+

**Cobra**  
RC Toys™

# MONSTER GT 4WD

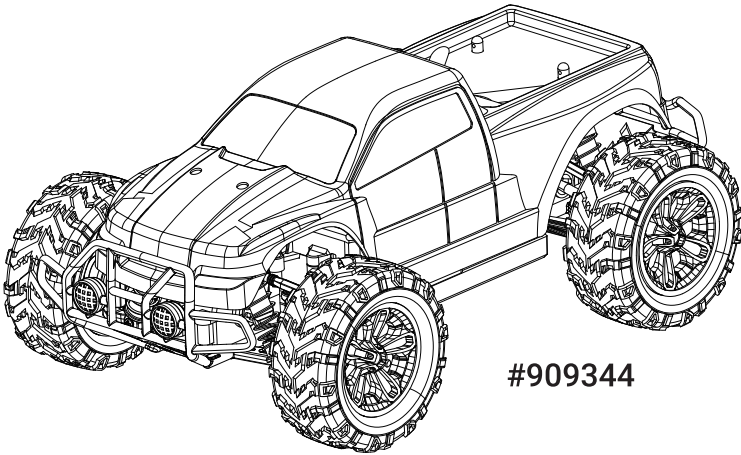

#909344

**1:16 Full-scale 4WD Vehicle**

Read this manual carefully prior to use.

# ! Important

- This product is not suitable for children aged 10 or under. When using electrical products, precautions must be taken to prevent the risk of an electric shock.
- Ensure adult supervision at all times.
- This product is made with precision electrical components. Treat it like any electronic device and keep it away from any heat or moisture sources. A heavy crash where the product is damaged may result in a product that is unsafe to use.



**WARNING:**  
**AVERTISSEMENT :**  
**CHOKING HAZARD** small parts.  
Not for children under 3 years.  
**RISQUE DÉTOUFFEMENT**  
ne pas laisser les petites pièces à la portée  
des enfants de moins de 3 ans.



## Introduction of remote control

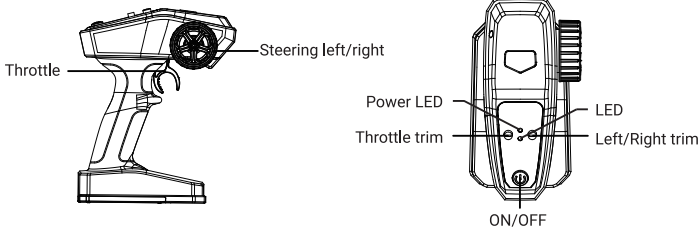

## Introduction of remote control vehicle

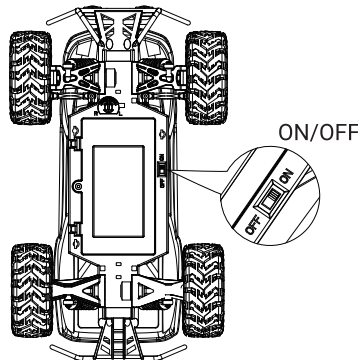

## Inserting the remote control batteries

1. Check the ON/OFF switch is in the "OFF" position.
2. Use a screwdriver to loosen the screw.
3. Remove the battery cover.
4. Note the polarity indicated inside the remote control. Put 4\*AA batteries into the battery compartment.
5. Put the battery cover back and tighten the screw.

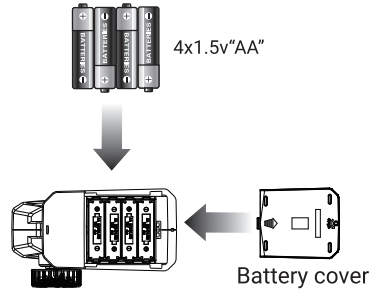

## Installing the rechargeable car battery

1. Check the ON/OFF switch is in the "OFF" position.
2. Use a screwdriver to loosen the screw.
3. Remove the battery cover.
4. Install the battery as indicated in the picture on the right
5. Connect the rechargeable battery in the battery pack as indicated in the picture.
6. Put the battery cover back and tighten the screw.

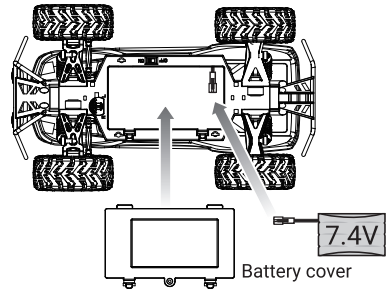

### Note:

If you experience a crash or the car won't move forward, remove the battery for one minute and then reinstall it. If it still doesn't work, the battery has been depleted and needs to be recharged.

## Using the vehicle

- Switch on the vehicle power using the ON/OFF switch and place the vehicle on the ground or floor away from obstacles, people and pets.
- Next, switch on the controller power ON/OFF switch and press the throttle when you are ready to run the vehicle. The vehicle should auto sync the signal from the car to the controller. If the signal is not linked, you may need to power off the car and controller and try again.
- Always switch OFF the vehicle and remote control power after use for safety.
- The playing time is about 18 mins.
- The control range is about 60 meters, if out of 60 meters range, it may lose control.

# Charging the batteries

## A. Recharging the car battery

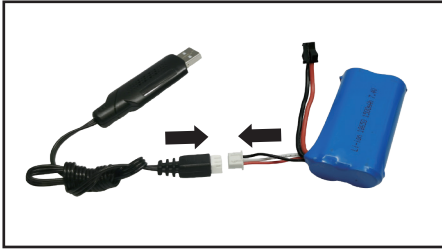

Connect the battery terminal and the adaptor terminal



Plug USB adaptor into a computer usb or standard USB charger.

## B. Battery charging

- Insert the USB charging into the socket. Insert the battery plug into the plug of the USB cable. Important: Note polarity when connecting, it only connects one way, please align correctly and DO NOT FORCE. Broken chargers are not covered under warranty claims.
- A full charge takes about 240 minutes. During charging, the LED indicator is red, when charging is complete, the LED indicator turns off. Do not leave a charging battery unattended, set a timer and disconnect when charging is complete.
- Regularly inspect the toy, battery charger, charging cable, connectors and other components for signs of damage. In the event of any damage, discontinue use and send the parts for repair. Contact Cobra toys customer service for replacement parts.
- Although unlikely, in case of abnormal conditions such as an unusual smell, noise or smoke during charging – discontinue the charging process and carefully take everything outdoors to a safe location.
- Please recharge with the dedicated USB delivered by the original factory. Never use broken USB or USB of other brands.
- Please do not recharge a swollen, leaking or broken battery.
- Do not overcharge the battery and be sure to disconnect promptly after charging is complete.
- Do not charge near or on flammable materials like carpet, wood, or furniture.

## Battery safety information

1. The batteries must only be charged under adult supervision.
2. Before charging the batteries, remove the battery compartment from the vehicle chassis.
3. Remove empty batteries from the vehicle and remote control.
4. Ensure that the vehicle is switched off before inserting the batteries.
5. Do not attempt to charge non-rechargeable batteries.
6. Do not short circuit the battery terminals.
7. If you do not plan to use the vehicle for an extended period, remove the batteries from the vehicle and remote control to prevent leakage.
8. Do not throw batteries into open flames, as this may cause them to explode or leak.

10. Do not mix old and new batteries or batteries from different manufacturers.
11. Only use batteries from recommended or reputable manufacturers.
12. Regularly inspect the batteries for signs of leakage.
13. It is suggested not to use more than 3 rechargeable batteries for one single play.
14. If leaking occurs in the battery, please avoid touching the liquid with the skin and eyes. If it touches the skin, please clean the skin with soap and clean water at once. If it touches the eyes, please wash the eyes with a lot of cold water and seek medical attention.
15. This equipment is composed of electronic components and battery. Any disposal must be in accordance with local regulations. Please dispose of in a responsible manner.
16. Retain this manual for future reference.

## Care and maintenance

- Remove the batteries when you do not plan to use the toy for an extended period.
- Use a damp cloth to wipe the vehicle clean.
- Do not expose the toy to high temperatures, moisture or direct sunlight.
- Do not immerse the toy in water, as this may damage the electrical components.
- If the wheel is too dirty or rolls inflexibly, this may influence the operation experience.
- Please check that the truck is free and clear of any materials that may impede proper operation and that may damage the vehicle.

## Caution

Do not hold the vehicle in your hands when the power is ON to avoid injury, do not touch the truck or wheels when it is in motion.



Although the vehicle is water resistant, avoid use in stormy or rainy weather and avoid puddles when possible.

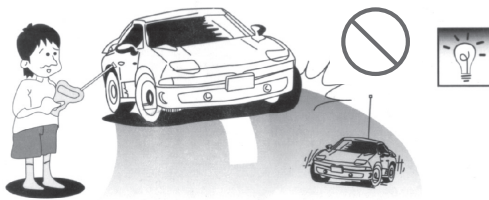

Do not use on any streets, near any cars, pedestrians, cyclists or animals. Please be a responsible RC user and use care and common sense.

# Function and operation of the product

## Forward

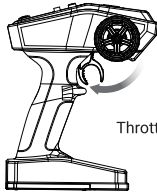

Throttle down

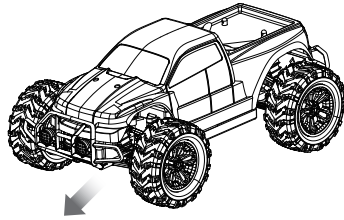

Pull the throttle downwards to make the vehicle move forwards.

## Backward

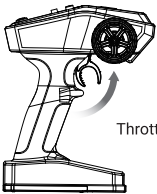

Throttle up

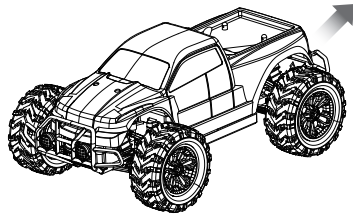

Push the throttle upwards to make the vehicle move backwards.

## Turn left

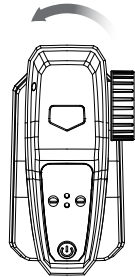
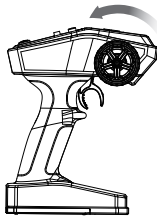

Turn the steering wheel to the left to make the vehicle turn left.

## Turn right

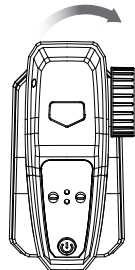
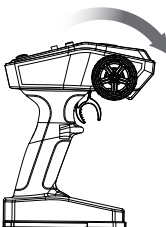

Turn the steering wheel to the right to make the vehicle turn right.

## Trim Settings

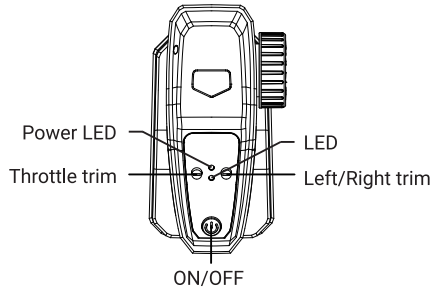

- If the vehicle veers to the left when driven forward, adjust the directional trim by turning the Left/Right trim button to the right until the vehicle drives in a straight line.
- If the vehicle veers to the right when driven forward, adjust the directional trim by turning the Left/Right trim button to the left until the vehicle drives in a straight line.
- **Throttle Trim:** You can control the maximum forward speed the car can travel by turning this control left (good for beginners) or turn to the right for maximum speed.

## 90 day Limited Warranty

Cobra RC Toys will repair or replace at it's own discretion any manufacturing defect within go days of original purchase. We will further pay for the return freight (only) to customers within the Continental US or Canada. Warranty excludes issues relating to mis-use, undue care and attention, breakage, abuse or from accidents resulting in crash damage. Void if any modifications whatsoever have been made. Issues relating to non original: parts, batteries or charging methods is also excluded. In addition, damage to the battery wires or connectors of this product is excluded.

Warranty claims require original proof of purchase from an Authorized Cobra RC Toys retailer.

**For warranty issues, spare batteries, replacement parts etc. contact customer service by visiting our website at: [www.cobratoys.com](http://www.cobratoys.com)**

Made in China

**Cobra**  
RC Toys™