

LED Semi Cut-Off Wall Pack Series

Wattages: 45W, 70W, 100W, 120W / Tunable Wattages: 30W/45W/60W/70W

LED Semi Cut-Off Wall Pack series can be widely used in indoor or outdoor lighting (wet location). Ideal for mechanical or electronic processing workshops, storage warehouses, steel mills, gas stations, toll booth, waiting rooms, the platforms of railway station, indoor stadiums.



WATT/CCT
FIELD-ADJUSTABLE

FEATURES

- Lumileds LED, high luminous efficiency and long working life.
- High efficiency LED Driver, the wide range input voltage AC120-277V/AC 277-480V.
- Excellent optics design, greatly improve the light utilization and evenness.
- Motion sensor control available (Optional)
- 1-10V Dimming.

Die-cast aluminum cooling design, high quality and better cooling for LED Tj < 85°C.



SPECIFICATION					
WATTAGE	45W	70W	100W	120W	30W/45W/60W/70W
LUMEN	6651 lm	10150 lm	14300 lm	17035 lm	4483 / 5896 / 7636 / 8776 lm
EFFICACY	147 lm/W	145 lm/W	143 lm/W	141 lm/W	up to 125 lm/W
CCT	4000K, 5000K				3000K/4000K/5000K
CRI	70				70
INPUT VOLTAGE	120-277V / 347V	120-277V / 277-480V			120-277V
POWER FACTOR	0.95				0.95
DRIVER EFFICACY	90%				90%
DIMMING	1-10V Dimming				1-10V Dimming
LIGHT ANGLE	97.1° X 70°	96.3° X 71°	136.8° X 74.8°	148° X 77.3°	97°X70°
LIFE SPAN	75,000 hrs				
WORKING TEMPERATURE	-22°F ~ 113°F				
STORAGE TEMPERATURE	-40°F ~ 176°F				
OUTDOOR RATING	Wet Location / IP66 Rating				
CABLE	Input Connect, No cable				
WARRANTY	5 year limited				

LED Semi Cut-Off Wall Pack Series

Wattages: 45W, 70W, 100W, 120W / Tunable Wattages: 30W/45W/60W/70W

CONTROLS (SOLD SEPARATELY)



P (Photocell)

WATT/CCT
FIELD-ADJUSTABLE

EMERGENCY BACK-UP (SOLD SEPARATELY)



BLD-CM20N-480800-8W
8W Emergency Backup Battery
LED Driver

BLD-CM20N-480800-15W
15W Emergency Backup Battery
LED Driver

BLD-CM20N-480800-20W
20W Emergency Backup Battery
LED Driver

ORDERING INFORMATION

EXAMPLE:

WSD-HWP-07W-27-50K-P

WSD	HWP	07W	27	50K	D	P
COMPANY	PRODUCT	WATTAGE	VOLTAGE	CCT	FINISH	CONTROL
WSD LED INC	HWP Semi Cut-Off Wall Pack	*45W - (45W) 07W - (70W) 10W - (100W) 12W - (120W)	27 (AC120-277V) *347 (AC347V) 48 (AC277-480V)	40K - (4000K) 50K - (5000K)	D - (Dark Bronze) W - (White) B - (Black) S - (Silver)	P - (Photocell)
		34567W - (30W/45W/60W/70W)	27 (AC120-277V)	345K - (3000K/4000K/5000K)		

LED Semi Cut-Off Wall Pack Series

Wattages: 45W, 70W, 100W, 120W / Tunable Wattages: 30W/45W/60W/70W

DIMENSION

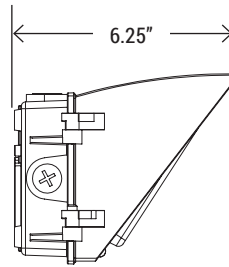
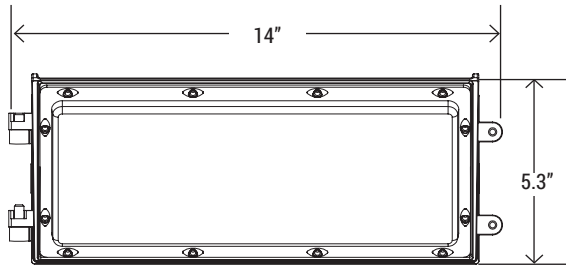

WATTAGE	45W
NT. WEIGHT	6.6 lbs/carton
BOX DIM.	15.5" x 8.85" x 8"

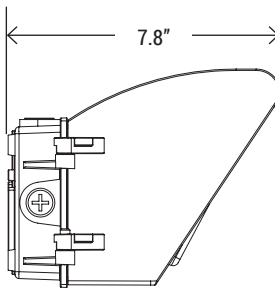
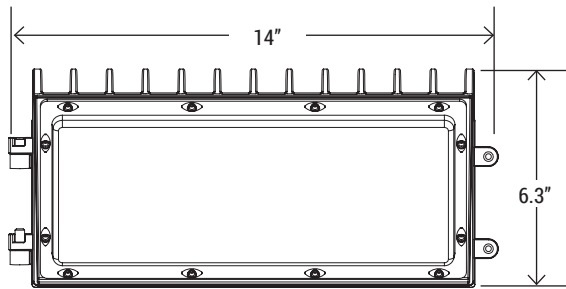

WATTAGE	70W
NT. WEIGHT	7.7 lbs/carton
BOX DIM.	15.5" x 10.23" x 8.6"

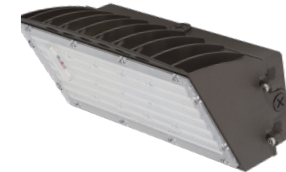
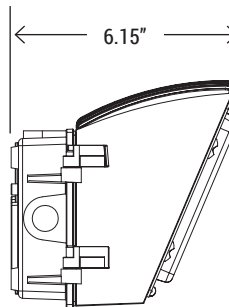
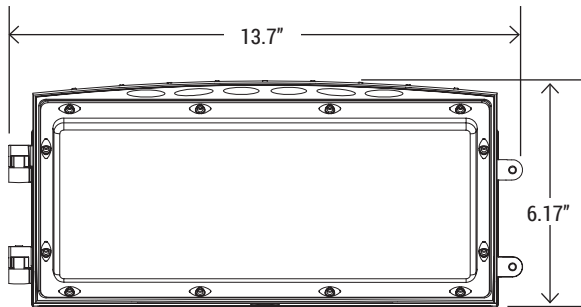

WATTAGE	100W / 120W
NT. WEIGHT	9.1 lbs/carton
BOX DIM.	16" x 9.25" x 9.25"

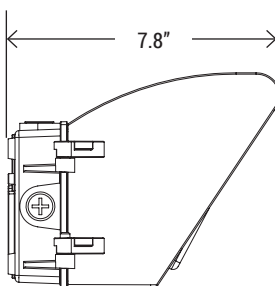
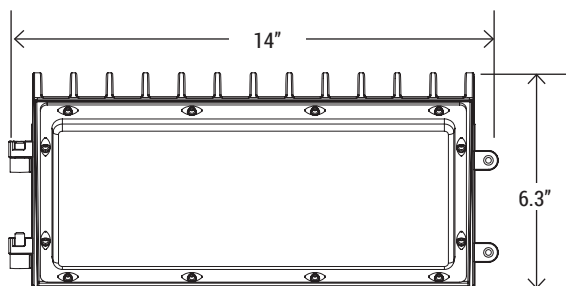

WATTAGE	34567W
NT. WEIGHT	6.88 lbs/carton
BOX DIM.	15.5" x 8.07" x 7"

LED Semi Cut-Off Wall Pack Series

Wattages: 45W, 70W, 100W, 120W / Tunable Wattages: 30W/45W/60W/70W

PHOTOMETRICS

For complete IES files, please visit our website.

WSD-HWP-45W27-50K

LUMINOUS INTENSITY DISTRIBUTION DIAGRAM

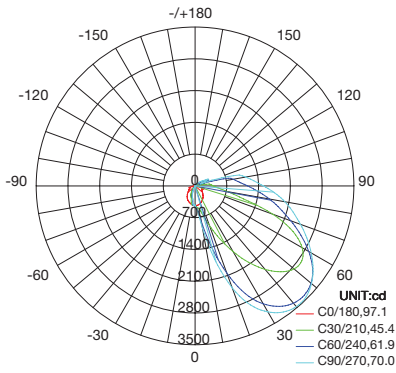

AVERAGE BEAM ANGLE(50%):68.6 DEG

C0 PLANE ISOLUX DIAGRAM (UNIT:lx)

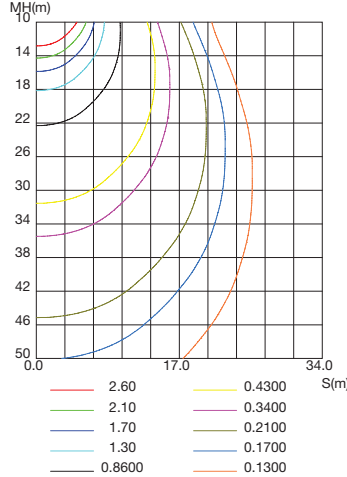

ISOLUX DIAGRAM

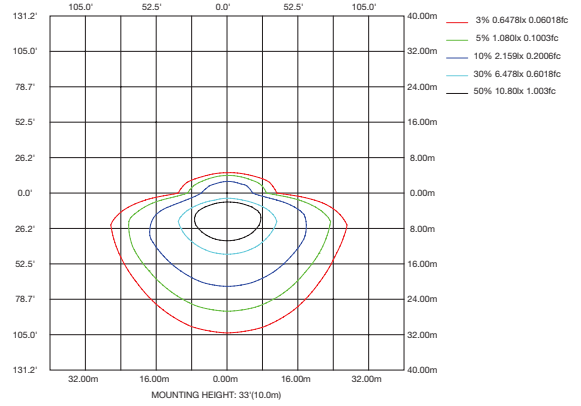

WSD-HWP-07W27-50K

LUMINOUS INTENSITY DISTRIBUTION DIAGRAM

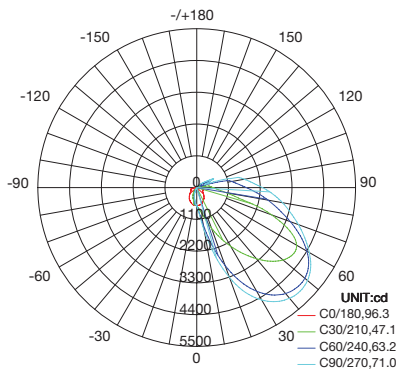

AVERAGE BEAM ANGLE(50%):69.4 DEG

C0 PLANE ISOLUX DIAGRAM (UNIT:lx)

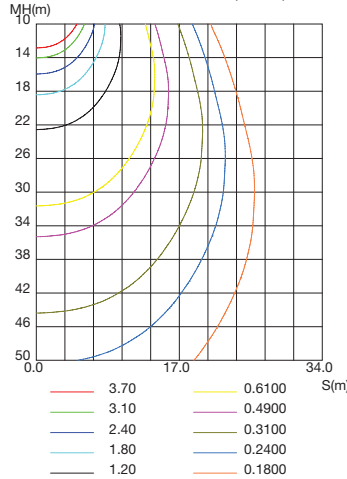

ISOLUX DIAGRAM

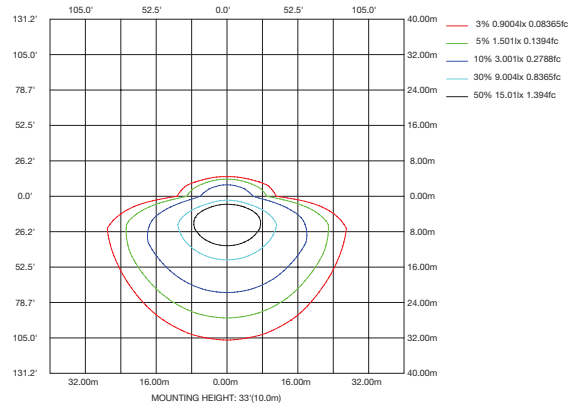

WSD-HWP-10W27-50K

LUMINOUS INTENSITY DISTRIBUTION DIAGRAM

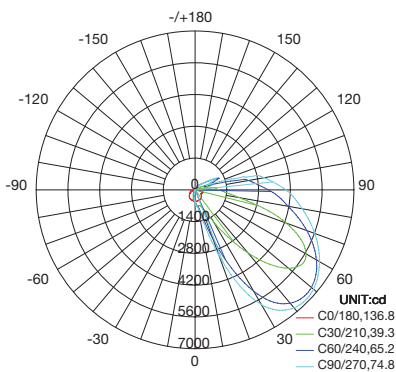

AVERAGE BEAM ANGLE(50%):79.0 DEG

C0 PLANE ISOLUX DIAGRAM (UNIT:lx)

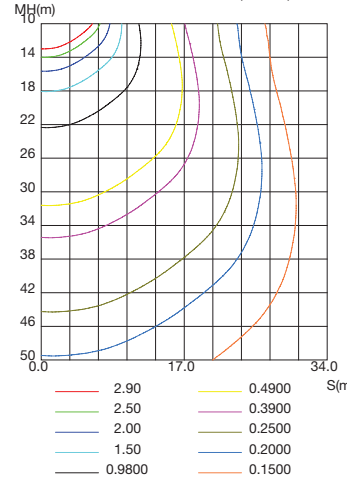

ISOLUX DIAGRAM

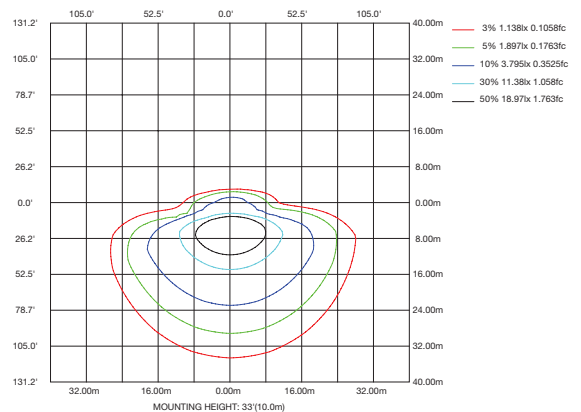

LED Semi Cut-Off Wall Pack Series

Wattages: 45W, 70W, 100W, 120W / Tunable Wattages: 30W/45W/60W/70W

PHOTOMETRICS

For complete IES files, please visit our website.

WSD-HWP-12W27-50K

LUMINOUS INTENSITY DISTRIBUTION DIAGRAM

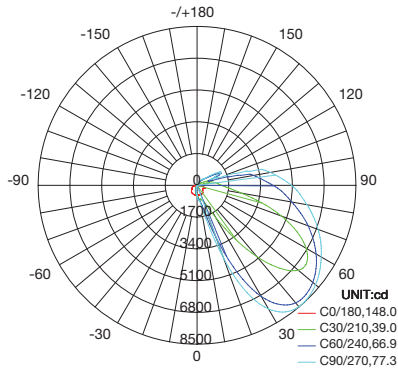

AVERAGE BEAM ANGLE(50%):82.8 DEG

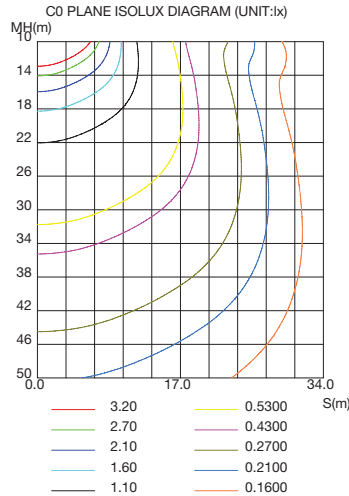

ISOLUX DIAGRAM

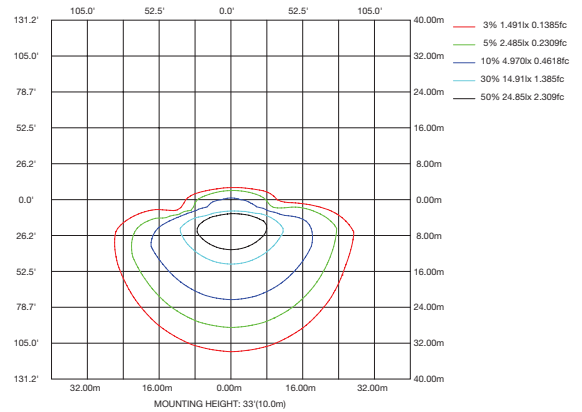

WSD-HWP-34567W27-50K (30W@50K)

LUMINOUS INTENSITY DISTRIBUTION DIAGRAM

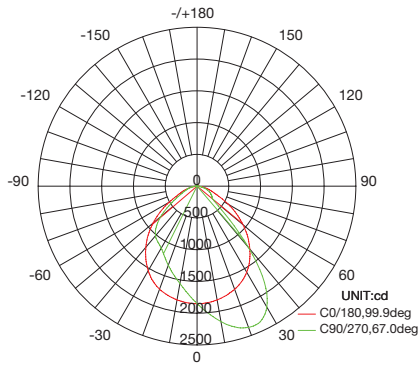

AVERAGE BEAM ANGLE(50%):83.5 DEG

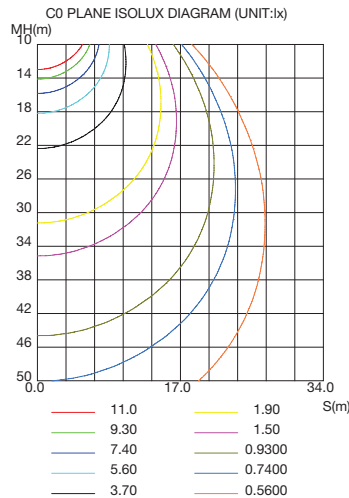

ISOLUX DIAGRAM

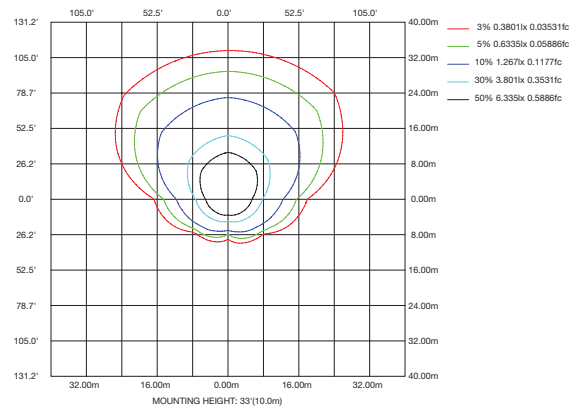

WSD-HWP-34567W27-50K (60W@50K)

LUMINOUS INTENSITY DISTRIBUTION DIAGRAM

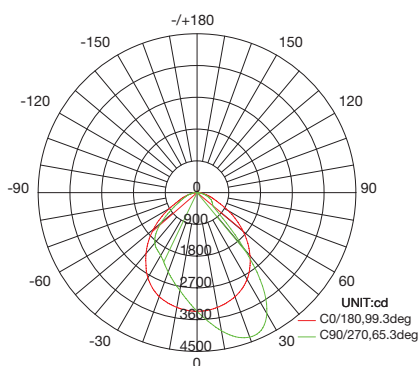

AVERAGE BEAM ANGLE(50%):82.3 DEG

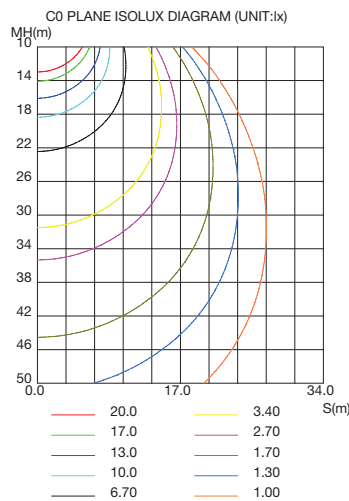

ISOLUX DIAGRAM

