

LED Flood Light Series

Wattages: 100W, 150W, 200W

WSD LED Flood Lighting series can be widely used in indoor or outdoor lighting (wet location). Ideal for excellent for museums, art galleries, shopping malls, office buildings, the lawn, walls, and many more applications.



FEATURES

- Lumileds LED, high luminous efficiency and long working life.
- High efficiency LED Driver, the wide range input voltage AC120-277V.
- Optics design, greatly improve the light utilization and evenness.
- Photocell Control Available (Option)

Die-cast aluminum cooling design, high quality and better cooling for LED Tj < 85°C.



SPECIFICATION			
WATTAGE	100W	150W	200W
LUMEN	14500 lm	21750 lm	29000 lm
EFFICACY	145 lm/W	145 lm/W	145 lm/W
CCT	4000K, 5000K		
CRI	70		
INPUT VOLTAGE	120-277V		
POWER FACTOR	0.99		
DRIVER EFFICACY	90%		
DIMMING	1-10V Dimming		
LIGHT ANGLE	120°		
LIFE SPAN	75,000 hrs		
WORKING TEMPERATURE	-22°F ~ 113°F		
STORAGE TEMPERATURE	-40°F ~ 176°F		
OUTDOOR RATING	Wet location/IP65		
CABLE	Input Connect, 0.5m		
WARRANTY	5 year limited		

LED Flood Light Series

Wattages: 100W, 150W, 200W

DIMENSION

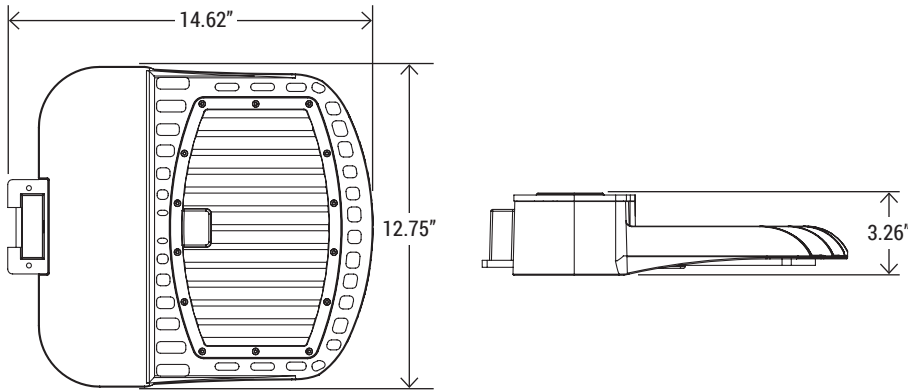

WATTAGE	100W
NT. WEIGHT	8.8 lbs (2 pcs/carton)
BOX DIM.	16.54" x 14.57" x 11.22"

WATTAGE	150W
NT. WEIGHT	9.3 lbs (2 pcs/carton)
BOX DIM.	16.54" x 14.57" x 11.22"

WATTAGE	200W
NT. WEIGHT	11 lbs (2 pcs/carton)
BOX DIM.	16.54" x 14.57" x 11.22"

MOUNTING OPTIONS



SLIPFITTER MOUNT

An optional cast aluminum cast arm adapter secures fixture head to nominal 2"(2-3/8"O.D. pipe size) horizontal steel tenon arm.



TRUNNION MOUNT

Wall Mount Wall Mount is easy to install for direct wall mounting with 1/2" conduit wiring mounting



ARM MOUNT

(For 4" and 5" Square and Round poles) Standard versatile mounting arm is simple to install and can be used with existing poles for retro fit installations.

PHOTOCELL/ACCESSORIES (SOLD SEPARATELY)



SBPBS-JB

For use in LED Shoebox light (optional)



LC-10DT

Used for indoor or outdoor LED lamps, working with light sensing principle, the LC-10DT sensor (LC-10DT for 120-277V) is used for Light sensor.

ORDERING INFORMATION

EXAMPLE:

WSD-FL-10W27-50K-D-S-P

WSD	FL	07W	27	50K	D	K	P
COMPANY	PRODUCT	WATTAGE	VOLTAGE	CCT	FINISH	MOUNTING	CONTROL
WSD LED INC	FL Flood Light Series	10W - (100W) 15W - (150W) 20W - (200W)	27 (AC120-277V)	40K - (4000K) 50K - (5000K)	D - (Dark Bronze) W - (White)	S - (Slipfitter) T - (Trunnion) A - (Arm)	P - (Photocell)

LED Flood Light Series

Wattages: 100W, 150W, 200W

PHOTOMETRICS

For complete IES files, please visit our website.

WSD-FL-10W27-50K

LUMINOUS INTENSITY DISTRIBUTION DIAGRAM

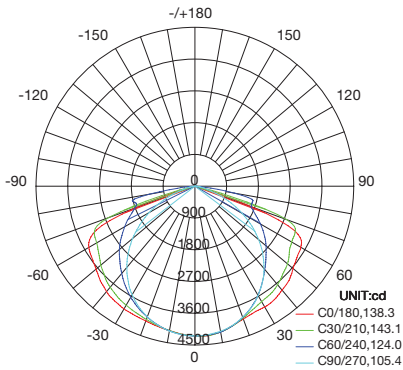

AVERAGE BEAM ANGLE(50%):127.7 DEG

C0 PLANE ISOLUX DIAGRAM (UNIT:lx)

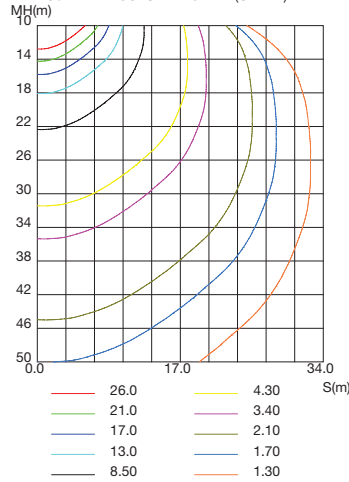

ISOLUX DIAGRAM

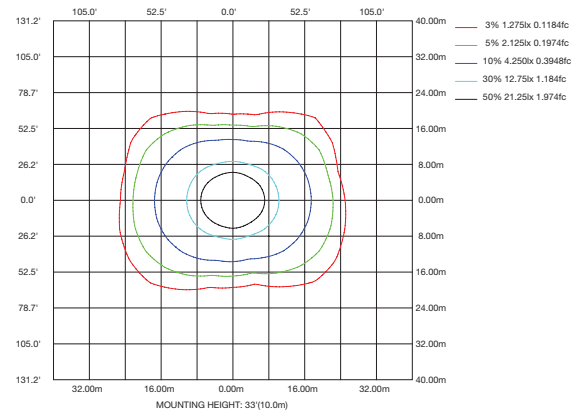

WSD-FL-15W27-50K

LUMINOUS INTENSITY DISTRIBUTION DIAGRAM

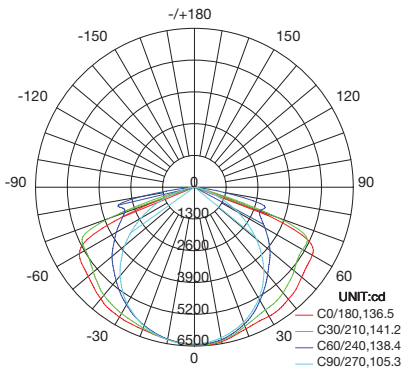

AVERAGE BEAM ANGLE(50%):130.4 DEG

C0 PLANE ISOLUX DIAGRAM (UNIT:lx)

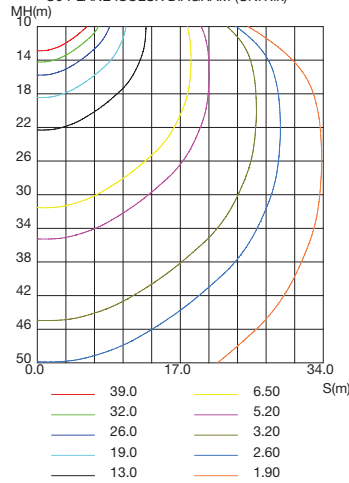

ISOLUX DIAGRAM

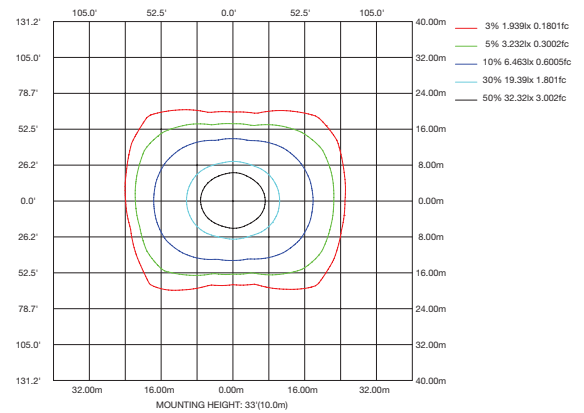

WSD-FL-20W27-50K

LUMINOUS INTENSITY DISTRIBUTION DIAGRAM

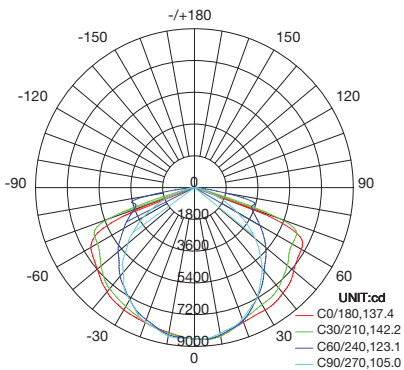

AVERAGE BEAM ANGLE(50%):126.9 DEG

C0 PLANE ISOLUX DIAGRAM (UNIT:lx)

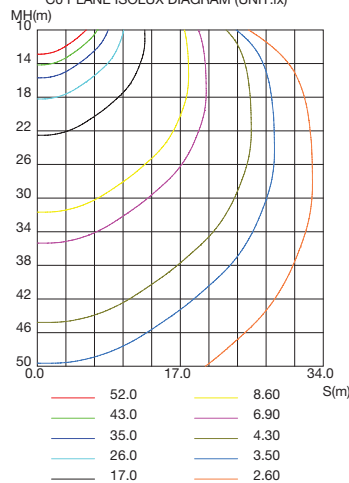

ISOLUX DIAGRAM

