

UCE SERIES UNDERCABINET LIGHTING

UCE-21-WHT

BUILDER SERIES 5CCT HARD-WIRE UNDER CABINET LIGHT, OPTIONAL CORD

MCT5 Multi Color Temperature (Selectable)

WESTGATE
THE FUTURE IS HERE...AND IT'S QUITE BRIGHT!

Customer Name: _____

Project Name: _____

Note: _____

Type: _____

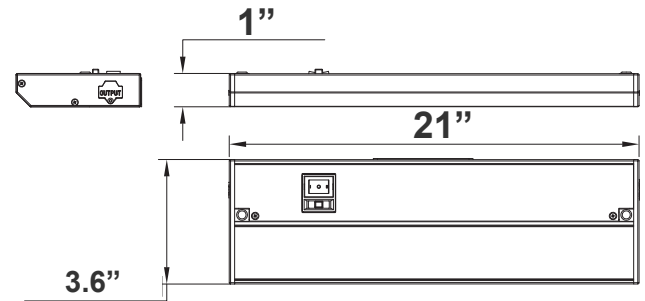

3.6"(H) X 21"(W) X 1"(D)

Brighten up your kitchen or workspace with our Builder-series undercabinet lights! Featuring a color temperature selectable switch and brightness adjustment, these lights offer customizable illumination to suit any environment. Experience the perfect blend of affordability, functionality, and innovation with Westgate Mfg. lighting solutions.

Features

- 7-Year Warranty
- Lifespan: 50000 Hrs
- Extruded Aluminum Housing With PC lens.

Technical Specifications

Electrical:

- Voltage: 120V/60Hz
- Wattage: 10W
- LED Wattage: >0.95
- THD: <20%
- Efficacy: 60 LM/W

Mechanical:

- Increase Energy Savings And Shorten Payback Period
- 5-Step Color-Temperature Switch on Front
- 3-Step Power & Brightness Switch on Front
 - On/Off
 - 50%
 - 100%
- 3/8" KOs Cable Connector Included Instant-on to Full Brightness
- Link Fixtures Together With A Linkable Connector
- Operating Temperature: -4 F° to 114 F°
- IP Rating: IP20

Lighting:

- Dimmable: Triac Dimmable
- Total Lumens: 600LM
- Color Temperature: 2700K/3000K/3500K/4000K/5000K (Based on 5000K and maximum Brightness)
- Color Rendering Index: >90
- Beam Angle: 110°
- Lifespan: 50000 Hrs.

Applications:

- Undercabinet Lighting
- Hospitality Lighting
- Residential Lighting

Other Model:

- 3W | 180LM | UCE-9-WHT • 5W | 300LM | UCE-12-WHT • 10W | 600LM | UCE-21-WHT • 12W | 720LM | UCE-24-WHT
- 16W | 960LM | UCE-32-WHT • 20W | 1200LM | UCE-40-WHT



Phone: (877) 805-2252 | Fax: (877) 805-2252
www.westgatemfg.com



WG-03012022

Other Views:



Side View



Front View



Included Accessories:
End-to-End Coupling
Mounting Screws

Performance Table: UCE-21-WHT

MODEL NO.	WATTS	Lumens	Color Temp.	BUG Rating	LPW
UCE-21-WHT	10W	600LM	2700K 3000K 3500K 4000K 5000K	B1-U2-G2	60

Sample Ordering

Model **Size** **Color**

UCE - 21 - WHT

Accessories

Blank = No Option
UCA-LC8-WHT = 8in LINKING CORD FOR UCE AND UCE SERIES, WHITE
UCA-PC-6FT-WHT = 6Ft POWER CORD FOR UCE AND UCE SERIES, WHITE

ACCESSORIES:



UCA-LC8-WHT



UCA-PC-6FT-WHT

