

META Up/Down Linear

Pendant | Architectural LED Linear



OKT Up/down linear is a commercial pendant lighting fixture utilizing an advanced LED optical system to achieve superior performance. The unique design is nearly transparent luminaire when off and excellent uniformity and efficiency when on, reaching 55% downlighting and 45% uplighting distribution, making the illusion of the light floating in mid-air. It has CCT adjustable optional function which is available in 3000K, 3500K and 4000K. It's highly engineered luminaire joining design allows for simple and intuitive assembly in the field without tools which is perfect for applications that include conference rooms, open offices, retail settings, anywhere you want to make a statement.

Features

- UL, cUL Listed, DLC Qualification, Damp Rated
- Available in 4' and 8' length
- Transparent optics
- 55% downlight and 45% uplight distribution
- Internal & replaceable driver
- CCT adjustable from 3000k, 3500k, 4000k
- Seamless continuous runs



PERFORMANCE

Dimension	Wattage	Efficacy
8"x4'	40W	1150lm/ft, 10w/ft
8"x8'	80W	1150lm/ft, 10w/ft

All efficacy is ±5% base on different CCT. Check the IES file to gain the accurate data.



*DesignLights Consortium Qualified and classified for DLC standard/premium, refer to www.designlights.org for details

META Up/Down Linear

Pendant | Architectural LED Linear



STRUCTURE

► Optics

High precision light guide made of PMMA material, allows distribution of controlled light to create 45% uplight, 55% downlight light distribution.

► Finish

Extruded aluminum housing.

Powder coat white finish is standard. Optional silver, black or custom.

► Electrical

Driver	Internal, class 2, replaceable, high efficiency LED driver.
Dimming	Standard constant current electronic driver with 1-10V dimming input; dimming range from 100% down to 10%. Tested Dimmers: Lutron® Diva-Dvtv, Leviton® IP-710-DL. Thermal overload protection shuts down the luminaire when system temperatures exceed designed operating conditions.
THD	<20%
Power Factor	>0.9
Input Voltage	110-277V or 110-347V *

► LED System

CRI	Minimum 80 color rendering index
CCT	Choice of 3000K, 3500K, 4000K color temperature or CCT adjustable from 3000K, 3500K and 4000K with a great color consistency.
LED	Life minimum 50,000h with 87.8% of lumen maintenance in 25°C ambient temperature, in compliance with IES LM-80 testing measurements.
Thermal Management	Aluminum housing acting as the heat sink to maximize life.
Environment	Damp rated in operating ambient temperatures of -20~40°C.

► Mounting

Pendant-Dry ceiling or T-Grid ceiling compatible. Cable lengths of 5ft is standard, 12ft or others are available. Individual or continuous run.

► Approvals

- cULus listed for damp locations
- Tested to IESNA LM-79 and LM-80
- DesignLights Consortium Qualified and classified for DLC Standard, refer to www.designlights.org for details
- 5 years limited warranty

► Optional Function

Emergency Option



Optional high voltage 8W emergency LED driver EM-H series can be provided. When AC power fails, it immediately switches to the emergency mode, operating for lighting up to 120 minutes. When AC power is restored, it automatically returns to the charging mode which meets critical life-safety lighting requirements.

For more info or spec sheet, please visit our website or contact sales.

Occupancy Sensor



We can provide a factory-installed integrated sensor system for multi-level control based on motion and/or daylight contribution with BR1810BI-level & daylight harvest microwave sensor from SHARKWARD. For more info or spec sheet, please contact sales.

PRODUCT ORDERING GUIDE

Sample

DP4 - DM - 35T
1 2 3



1. Length & Wattage

- DP4 8"X4' 40W
 DP8 8"X8' 80W

2. Dimming

- DM 1-10V Dimming

3. CCT

- 35T CCT Adjustable 3000K, 3500K, 4000K
 30E 3000K *
 35E 3500K
 40E 4000K

OPTIONAL ORDERING GUIDE

Ceiling Type

- Dry Wall (Mount to J-box)
 Drop Ceiling Clips (Suitable for 9/16" and 15/16" Flat Ceiling)
 Drop Ceiling Clips (Suitable for 9/16" Slot Ceiling)
 Drop Ceiling Clips (Suitable for 15/16" Slot Ceiling) *

Canopy

- 1.6" Round
 4.5" Round (Designed for power cable)
 5.8" Round With Occupancy Sensor (Power Feed)
 1.6" Square
 4.5" Square (Designed for power cable)

Optional Function

- LED Emergency Driver (Order Separated)
 Occupancy Sensor (Order Separated)

*Additional cost and/or lead time on customized fixtures may apply. Some fixtures require an MOQ. Please contact your sales rep for more information.

META Up/Down Linear

Pendant | Architectural LED Linear



DIMENSIONS

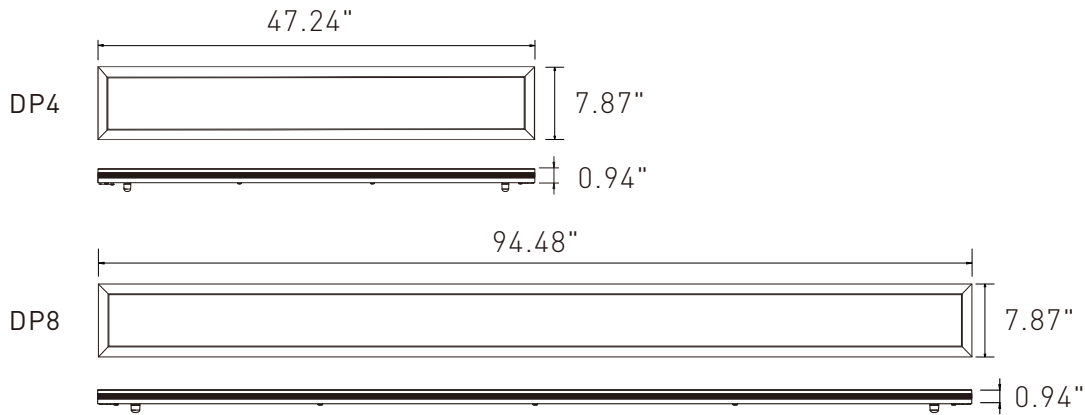

MOUNTING

Canopy Style

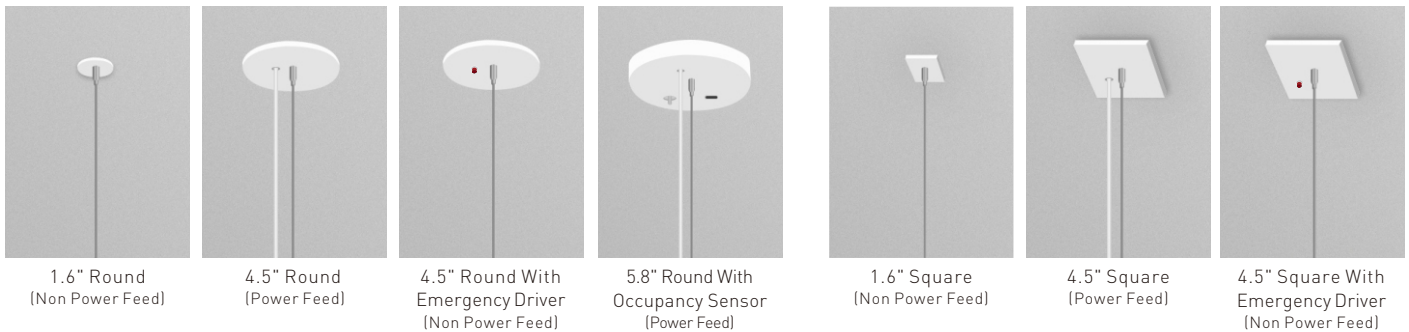

Dry Ceiling / Off Grid

"Various Hard Ceilings"
(Mount to J-box)

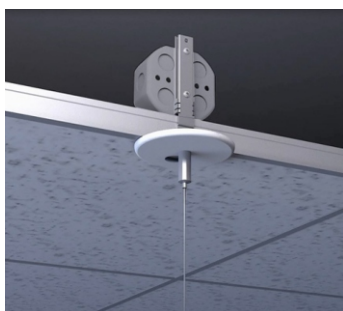
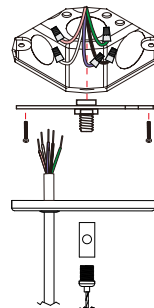
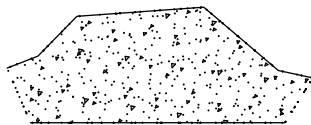

Drop Ceiling / On Grid

Suspending the luminaire in the T-grid. Compatible for various T-grid, including 9/16" Flat, 9/16" Slot, 15/16" Flat.

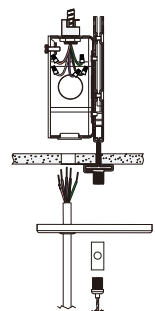
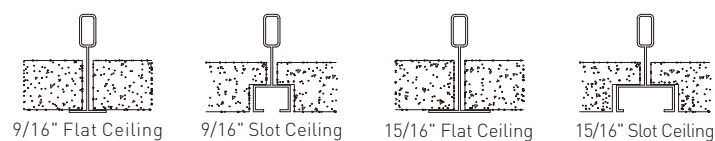

*Please see the installation instruction for more details.

META Up/Down Linear

Pendant | Architectural LED Linear



Individual

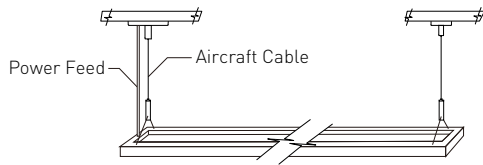

Continuous Run

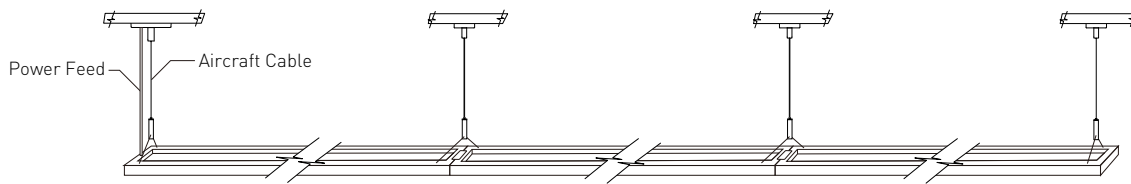

- 4' Connect 9pcs together in 120V AC and 20pcs in 277V AC
- 8' Connect 4pcs together in 120V AC and 10pcs in 277V AC

Standard Line Runs In 120V

Luminaire Run Length (ft)	Run Configuration	5' Power Cable	5' Aircraft Cable	Canopy
4	4'	1	2	2
8	8'	1	3	3
12	4'+8'	1	4	4
16	8'+8'	1	5	5
20	8'+8'+4'	1	6	6
24	8'+8'+8'	1	7	7
28	8'+8'+8'+4'	1	8	8
32	8'+8'+8'+8'	1	9	9
36	4'+4'+4'+4'+4'+4'+4'+4'+4'+4'	1	10	10

META Up/Down Linear

Pendant | Architectural LED Linear



DISTRIBUTION DIAGRAM

8"x4' CCT Adjustable

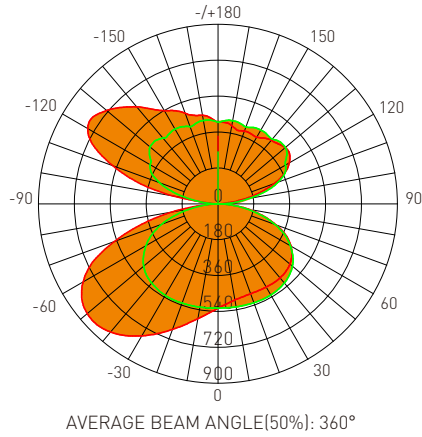

Test Number: DP4-DM-35T
 Lumens: 4828.5 Lm
 Watts: 40 W
 LPW: 120.71 Lm/W
 CCT: 3500K

UNIT: cd
 — C0/180,360
 — C90/270,360

Zonal Flux Diagram

τ	C0	C45	C90	C135	C180
10	489.7	498.0	524.6	563.6	584.7
20	480.0	486.6	527.3	616.1	670.1
30	482.5	481.7	528.7	668.3	764.4
40	484.9	472.9	518.0	702.8	838.6
50	470.2	447.9	487.2	694.4	856.3
60	422.0	393.3	418.8	618.6	781.1
70	309.9	292.1	305.3	452.8	554.8
80	154.1	142.3	143.6	198.8	234.2
90	0	0	0	0	0
100	118.0	129.0	158.1	189.3	221.4
110	301.4	288.1	321.0	422.0	562.4
120	413.0	389.2	391.3	557.4	754.7
130	439.9	415.6	440.80	572.0	729.0
140	417.2	406.8	424.6	534.9	635.6
150	387.6	395.4	428.1	495.7	540.1
160	388.5	394.1	410.7	466.6	484.1
170	399.0	401.0	423.8	437.1	451.1
180	410.1	410.1	410.1	410.1	410.1
DEG	LUMINOUS INTENSITY:cd				

Zonal Lumens

τ	φ total
0-10	50.33
10-20	203.9
20-30	465.4
30-40	832.8
40-50	1286
50-60	1775
60-70	2217
70-80	2503
80-90	2575
90-100	2635
100-110	2918
110-120	3349
120-130	3796
130-140	4177
140-150	4466
150-160	4668
160-170	4788
170-180	4828
DEG	UNIT: lm

Luminance cd/(m2)

G(DEG)	C0/180	C90/270
85	6686	7045
80	8875	8271
75	9044	8773
70	9061	8926
65	8934	8769
60	8441	8375
55	7885	7996
50	7315	7580
45	6799	7158

8"x4' Standard

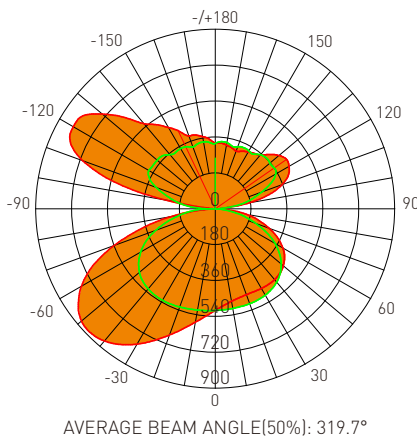

Test Number: DP4-DM-35E
 Lumens: 4607.9 Lm
 Watts: 40 W
 LPW: 115.20 Lm/W
 CCT: 3500K

UNIT: cd
 — C0/180,279.4
 — C90/270,360

Zonal Flux Diagram

τ	C0	C45	C90	C135	C180
10	471.3	481.6	507.7	554.6	577.5
20	458.6	467.9	506.7	609.4	673.9
30	462.1	461.8	500.8	659.3	783.5
40	464.3	450.9	480.5	679.8	865.5
50	445.3	417.1	432.6	641.6	875.9
60	391.2	349.2	346.4	529.5	774.6
70	288.2	240.5	216.9	339.6	540.6
80	158.5	110.5	82.70	107.0	218.7
90	0	0	0	0	0
100	174.4	125.4	126.5	130.4	244.7
110	357.6	281.0	248.6	384.3	707.6
120	427.2	369.7	350.1	531.4	822.0
130	416.8	368.4	358.0	519.1	739.8
140	352.0	337.4	354.5	457.1	557.6
150	329.5	319.4	336.6	411.6	471.2
160	308.0	315.6	331.5	377.9	389.2
170	325.0	315.7	337.6	347.6	368.3
180	328.7	328.7	328.7	328.7	328.7
DEG	LUMINOUS INTENSITY:cd				

Zonal Lumens

τ	φ total
0-10	49.09
10-20	199.2
20-30	456.0
30-40	818.2
40-50	1262
50-60	1733
60-70	2144
70-80	2408
80-90	2484
90-100	2557
100-110	2872
110-120	3314
120-130	3740
130-140	4074
140-150	4315
150-160	4479
160-170	4576
170-180	4608
DEG	UNIT: lm

Luminance cd/(m2)

G(DEG)	C0/180	C90/270
85	7058	1641
80	9128	4763
75	8707	5855
70	8426	6343
65	8198	6743
60	7824	6928
55	7390	6860
50	6927	6729
45	6481	6511