

SOLN SERIES

Outdoor Lighting

WESTGATE
THE FUTURE IS HERE...AND IT'S QUITE BRIGHT!

SOLN-30W-30K
SOLN-30W-50K
LED SOLAR ROADWAY/FLOOD LIGHTS

Customer Name: _____

Project Name: _____

Note: _____

Type: _____

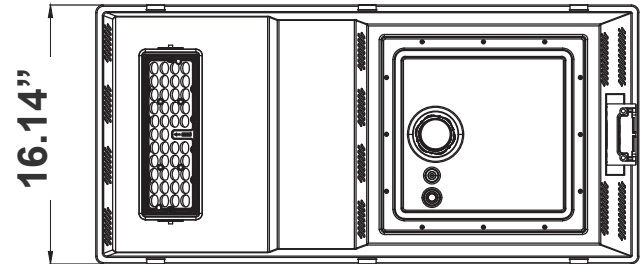

16.14"(H) X 33.86"(W) X 4.41"(D)

Ideal for general site lighting, alleys, loading docks, doorway, pathway, and parking areas.

Features

- 7-Year Warranty
- Die-cast Aluminum with powder coat finish (light Grey)
- Lifespan: 70000 Hrs.
- Lens: TYPE III TIR optic Lens

Technical Specifications

Electrical:

- Voltage: 100~130VAC 50/60Hz
- Solar Panel Wattage: 36W
- LED Wattage: 30W
- Power Factor: 0.95
- Efficacy: 200 LM/W

Mechanical:

- No wires
- Die-cast Aluminum with powder coat finish (light Grey)
- Smart Lighting controller & remote control to charge settings (Remote is not included)
- Operating temperature: 14°F to 122°F
- IP Rating: IP65

Battery:

- Battery charge time to full level: 6 to 12 hours depending on the sunlight quality, see the map on page 3
- Battery Type: LiFePO4
- Battery Life: More than 2000 Cycles (2000/365days=5.47 years) with Overcharge and Over-discharge protection
- Operation on full charge: 10 hrs. depending on the sunlight quality, see the map on page 3

Lighting:

- Lens: TYPE III TIR optic Lens
- LED: Lumileds Luxeon 5050
- Total lumens: 6000LM
- Color temperature: 3000K/5000K
- Color rendering index: >70
- Lifespan: 70000 Hrs.

Applications:

- Ideal for Ideal for doorway, pathway and alleys
- Great for use with optional motion sensors or photocell



- The SOLF-RC remote control is needed per job. 1 remote control can control all the fixtures. order 1 per job.

see the instruction on page 4

Other Model:

- 50W | 10000LM | SOLN-50W-30K
- 50W | 10000LM | SOLN-50W-50K



Phone: (877) 805-2252 | Fax: (877) 805-2252
www.westgatemfg.com



WG-03012022

Photometrics: SOLN-30W

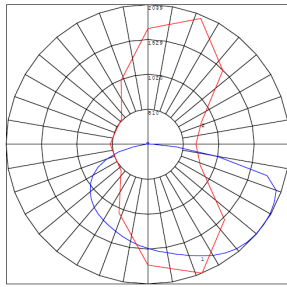
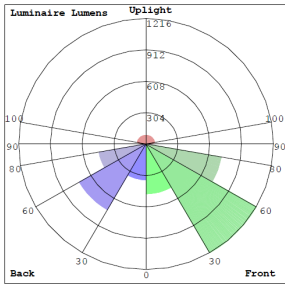

BUG Rating: B1-U3-G0

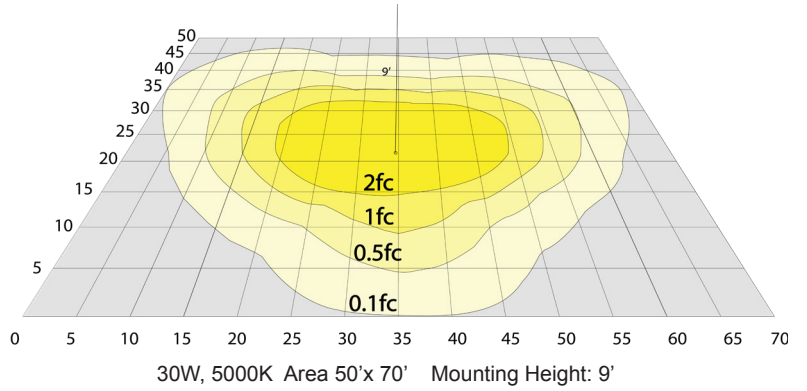

Other Views:



Close View



Front View

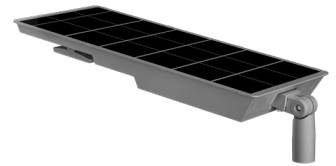

Back View
Shown with Slip Fitter (NOT INCL.)

Performance Table: SOLN-30W

MODEL NO.	SOLAR PANEL WATTS	Lumens	Color Temp.	BUG Rating	LPW
SOLN-30W	30W	6000LM	3000K 5000K	B1-U3-G0	200

Sample Ordering

Model **Min. Watt** **Color Temp.**
 - -
30K = 3000K
50K = 5000K

Accessories

Blank = No Option
 SOLN-SFA = SOLN Series Slip Fitter Mounting Accessory
 SOLN-WM-15-30W = SOLN 15-30W Wall Mounting Accessory
 SOLN-PMRS-15-30W = SOLN 15-30W Round And Square Pole Mounting Accessory
 SOLF-RC = Remote Control for SOLN Series (One Per Project)



SOLN-SFA

SOLN-PMRS-15-30W
Round & Square
Pole Mounting Accessory

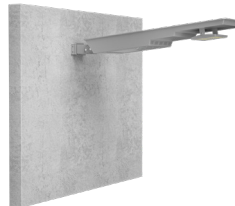

SOLN-WM-15-30W



SOLF-RC



Drawings:



Wall Mounting

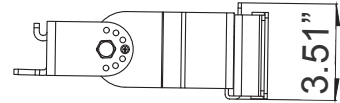
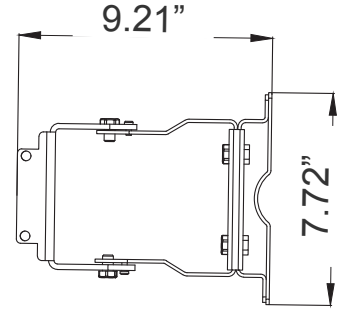

9.21"(W) x 7.72"(H) x 3.51"(D)



Round & Square -Hoop

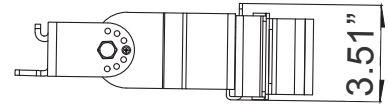
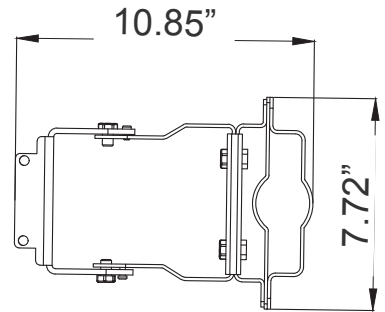

10.85"(W) x 7.72"(H) x 3.51"(D)

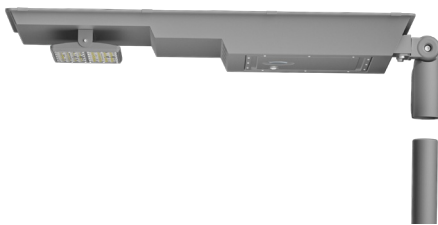

Slip Fitter

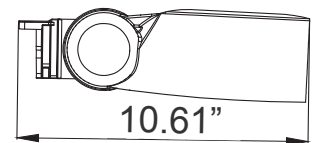
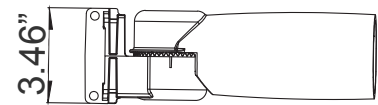

10.61"(W) x 3.46"(H)



Average Daily Solar Radiation Per Month:

Increasing the tilt 15° in the winter or decreasing 15° in the summer gives the maximum sunlight for recharging the battery.

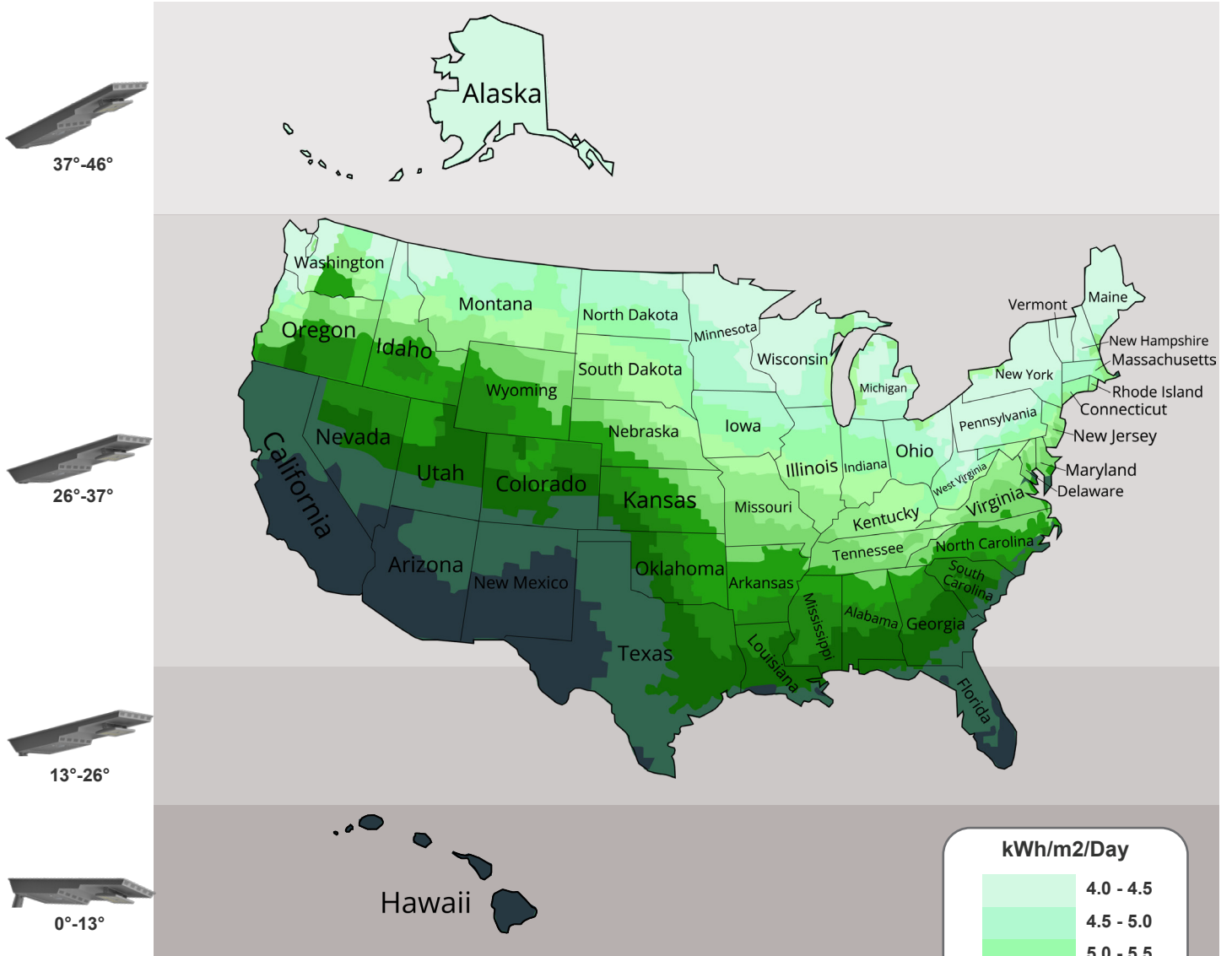

- The best facing direction for the solar panel is toward the south. facing west & east & north will provide less sunlight, resulting in a long time to charge the battery. The solar charge will be less optimal if the installation is facing north.



Introduction of Remote Control button

Note: Remote control not included **MUST BE PURCHASED** separately-1 Per Project

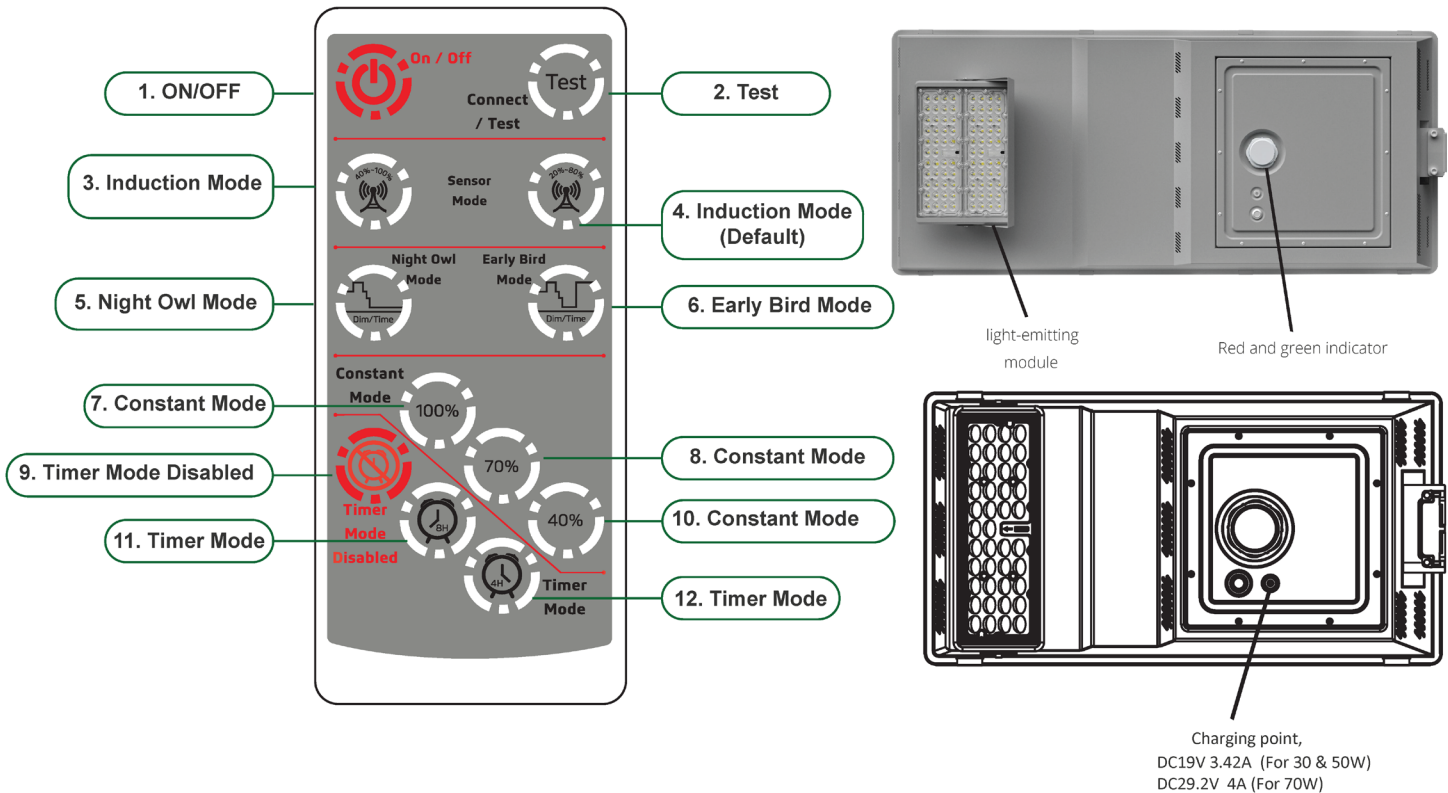

Function:

1. **ON/OFF**: when ON/OFF is pressed, the indicator blinks red if the fixture is fully charged and ready to work. The indicator blinks green if the battery power is less than 10%. If the indicator doesn't blink upon restart, contact the manufacturer.
2. **Test**: To sync the remote control with the lighting fixture, press hold for 3 seconds, then release this button. To test, press it once. If the test is successful, the fixture will light up to full brightness, dim down, and prepare for the next steps. If the test is unsuccessful, the fixture is either out of charge or turned off. Testing time lasts 10 seconds, and then it goes back to the previous mode in use.
3. **Induction Mode 40% - 100%**: Constant 40% brightness (turn on at dusk, turn off at dawn); the light goes on 100% brightness for 30 seconds when motion is detected
4. **Induction Mode 20% - 80% (Default)**: Constant 20% brightness (turn on at dusk, turn off at dawn); the light goes on 80% brightness for 30 seconds when motion is detected
5. **Night Owl Mode**: Based on night-time activities: 70% brightness for Hour 0 (Dusk)-0.5, 100% brightness for Hours 0.5-3.5, 70% brightness for Hour 3.5-4.5, 50% brightness for Hour 4.5-5.5, 20% brightness for Hours 5.5-11 (Dawn).
6. **Early Bird Mode**: Based on night-time activities with increased brightness for early risers: 70% brightness for Hour 0 (Dusk)-0.5, 100% brightness for Hours 0.5-3.5, 70% brightness for Hour 3.5-4.5, 50% brightness for Hour 4.5-5.5, 20% brightness for Hours 5.5-10, 70% brightness for Hour 10-11 (Dawn).
7. **Constant Mode 100%**: 100% brightness from dusk to dawn. Suitable for areas and seasons with sufficient sunlight.
8. **Constant Mode 70%**: 70% brightness from dusk to dawn. Suitable for areas and seasons with sufficient sunlight.
9. **Timer Disabled**: Press this button to turn off Timer Mode; Settings go back to the previous mode that was set before timer mode.
10. **Constant Mode 40%**: 40% brightness from dusk to dawn. Suitable for areas and seasons with sufficient sunlight.
11. **Timer Mode 4 Hours**: Light turns off 4 hours after it turns on (dusk). For example: Press this button at any time; if the light turns on at 7pm, it will turn off at 11 pm. It will repeat the same schedule hereafter until it is canceled by using 10 Timer Disabled.
12. **Timer Mode 8 Hours**: 8 Hours Light turns off 8 hours after turning on (dusk). For example: Press this button at any time; if the light turns on at 7 pm, it will turn off at 3 am. It will repeat the same schedule hereafter until it is canceled by using 10 Timer Disabled.

- The range of the remote control to the indicator is 16ft (Day time) to 33ft (Nighttime). Because the sunlight will impact the signal of the remote control, we recommend that users set up the mode before they install the light.

