

LEDBARKIT-INTERNAL DRIVER (LBI) THE LINEAR TRANSFORMER

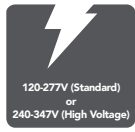

VOLTAGE
(240-347V FOR CANADA ONLY)



SENSOR READY



EFFICACY
(LIGHT ENGINE)



OPERATING TEMP



BEAM ANGLE

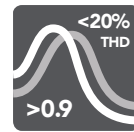

PWR FACTOR/THD

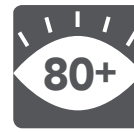

CRI



OPTIONAL EMG
BATTERY BACKUP



OPTIONAL
MOTION SENSOR

one light – unlimited possibilities

available
in PRO



DIMMABLE	✓ 0-10V
CONTROL POWER	✓ 12V
FLEX COLOR	✓
FLEX WATT	✓
WARRANTY	10YR
L70	>100,000 HRS

DEFAULT CONFIGURATIONS

PART #	UPC	DESCRIPTION	WATTAGE	LUMENS	LPW	CCT
RP-LBI-G1-2F-6W-27K-WC2	844006024826	2FT PRO WARM CCT INTERNAL DRIVE LIGHT BAR	6/9/12	696-1524	116-127	2700/3000/3500
RP-LBI-G1-2F-6W-40K-WC	844006023867	2FT PRO INTERNAL DRIVE LIGHT BAR	6/9/12	780-1560	126-137	3500/4000/5000
RP-LBI-G1-3F-10W-27K-WC2	844006024833	3FT PRO WARM CCT INTERNAL DRIVE LIGHT BAR	10/12/15	1270-1980	127-132	2700/3000/3500
RP-LBI-G1-3F-10W-40K-WC	844006023959	3FT PRO INTERNAL DRIVE LIGHT BAR	10/12/15	1400-2100	137-142	3500/4000/5000
RP-LBI-G1-4F-15W-27K-WC2	844006024840	4FT PRO WARM CCT INTERNAL DRIVE LIGHT BAR	10/15/25	1260-3400	126-136	2700/3000/3500
RP-LBI-G1-4F-15W-40K-WC	844006024079	4FT PRO INTERNAL DRIVE LIGHT BAR	10/15/25	1462-3653	136-146	3500/4000/5000

Default settings are above. See pages 7 and 8 for additional styles, lumen packages, color temperatures and options.

POPULAR ACCESSORIES (SOLD SEPARATELY)

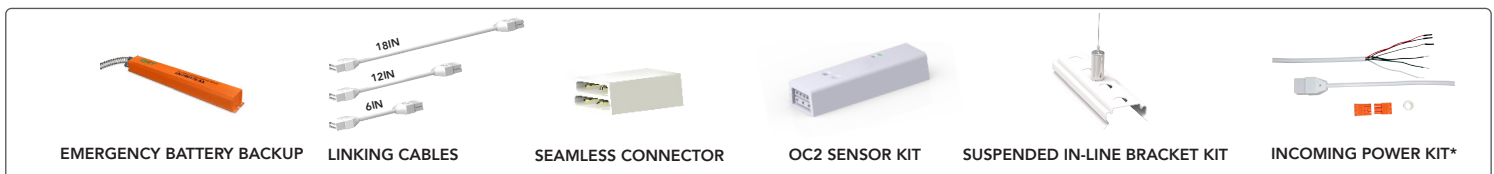

***INCOMING POWER KIT NOW SOLD SEPARATELY – SEE PAGE 3 FOR DETAILS**

(SEE PAGE 12 FOR MORE ACCESSORIES)



LIGHT EFFICIENT DESIGN HEADQUARTERS 188 S. Northwest Highway • Cary, IL 60013
INNOVATION & MANUFACTURING CENTER 30 Log Bridge Road, Building 200 • Middleton, MA 01949

847.380.3540 • led-llc.com

LED BARKIT-INTERNAL DRIVER (LBI) THE LINEAR TRANSFORMER



Usage & Applications

One solution. ETL listed as both a retrofit kit and a fixture.



Using the fast install magnetic brackets, light bars fit between any T5, T8 or T12 socketed fixture including

TROFFERS



Example 2x2 and 2x4 retrofitted with 3 light bars.



CONTINUOUS RUNS

UTILITY STRIP

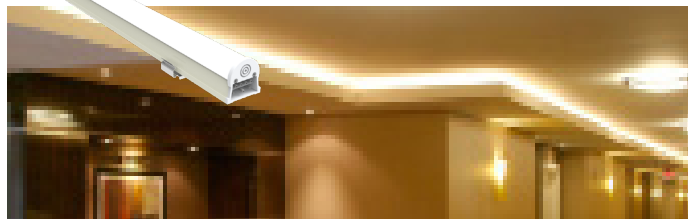

COVE LIGHTING

RETROFIT MOUNTING KITS

Mount light bar to a Retrofit Mounting Kit for a faster, cleaner install.
- contact us for details.

ETL listed as a fixture under the following categories

STAIRWELL FIXTURE

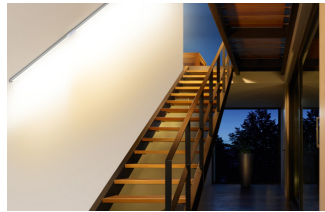

LINEAR AMBIENT FIXTURE

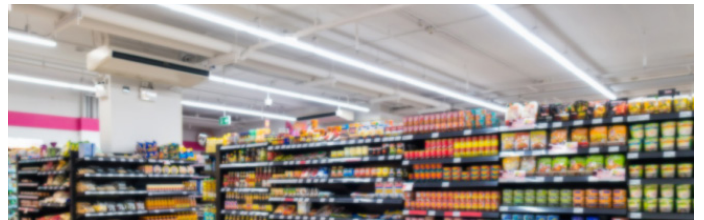

HIGH BAY FIXTURE (LOW CEILING HEIGHTS)

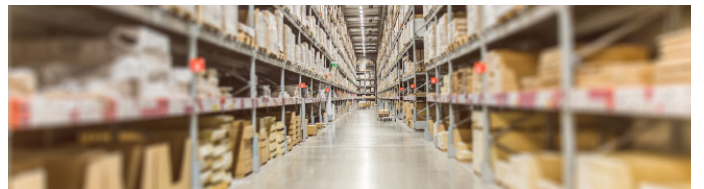

HIGH BAY FIXTURE (HIGH CEILING HEIGHTS)

FIXTURE HOUSING KITS

Mount light bar to a Fixture Housing Kit for a faster, cleaner install.
- contact us for details.



LED BARKIT-INTERNAL DRIVER (LBI) THE LINEAR TRANSFORMER



INCLUDED WITH EVERY BAR

2X Surface Mount Magnetic Clips
(w/ easy bend and break lines)

4X 1/4" hex head-self drilling screws

1X Flex setting cover



INCOMING POWER KIT: RP-LBI-G1-IP-3F-DIM – SOLD SEPARATELY

Kit Includes:

- 1 Incoming power cable (bar input side)
- 1 Service Disconnect
- 1 Abrasion protection grommet

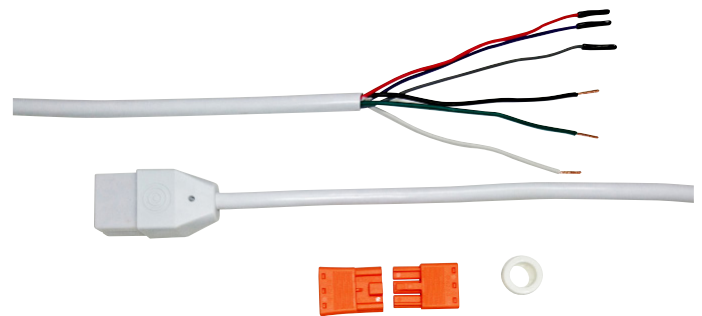

WIRING DIAGRAM

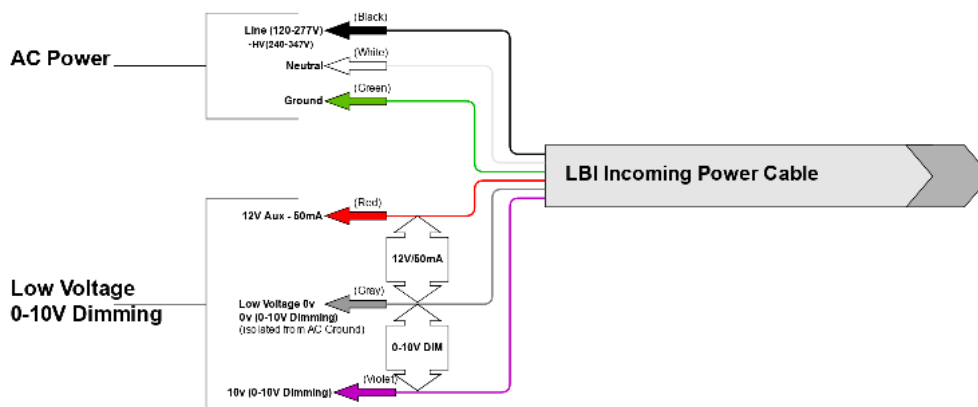

LIGHT EFFICIENT DESIGN HEADQUARTERS 188 S. Northwest Highway • Cary, IL 60013
 INNOVATION & MANUFACTURING CENTER 30 Log Bridge Road, Building 200 • Middleton, MA 01949
 847.380.3540 • led-llc.com

—○ LEDBarKit-Internal Driver (LBI) Design Guide

A comprehensive guide to understanding, specifying, stocking, and selling the LEDBarKit-Internal Driver fluorescent replacement.



The Linear Transformer

With up to 146 lumens per watt, and up to 25 years of virtually maintenance free operation, learn why smart decision makers use the The Linear Transformer when upgrading to LED.

—○ Perfect replacement for

- Linear and general purpose
- Strips & Wraps
- Troffers
- Vapor Tights
- Low bay and High bay
- Coves and Soffits
- Stairwells

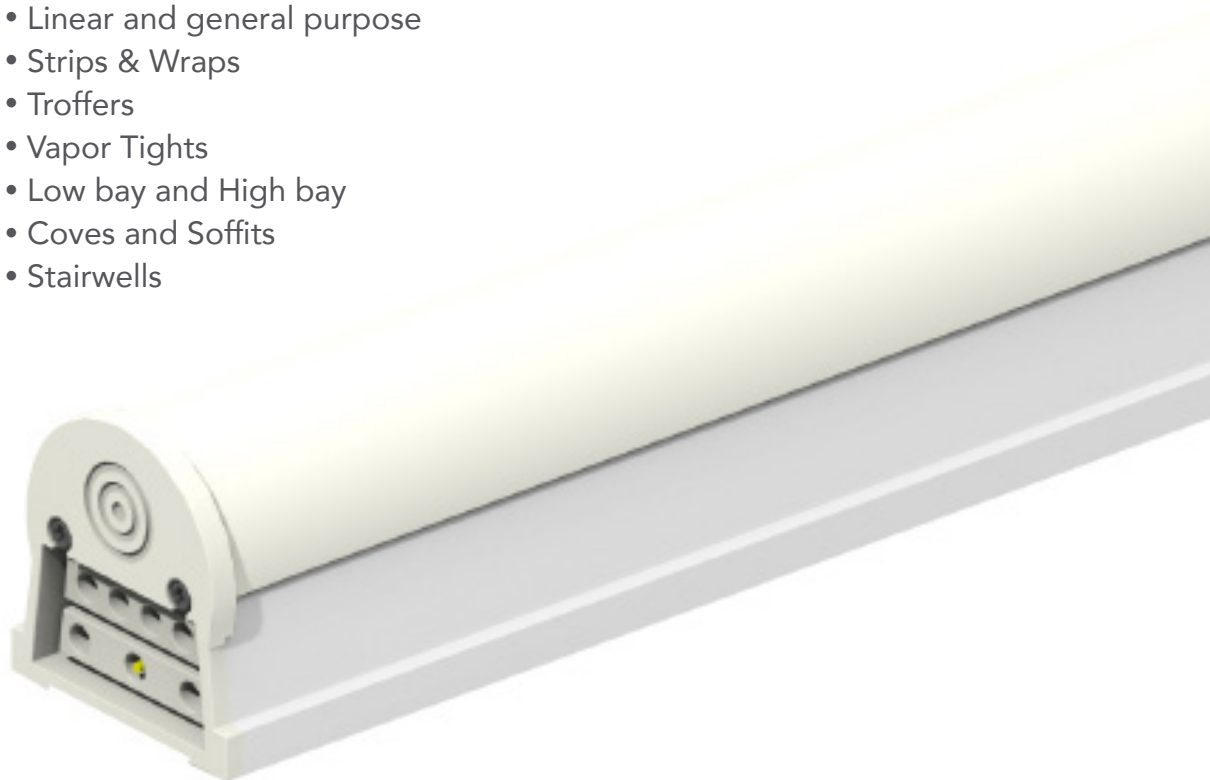

LIGHT EFFICIENT DESIGN HEADQUARTERS 188 S. Northwest Highway • Cary, IL 60013
INNOVATION & MANUFACTURING CENTER 30 Log Bridge Road, Building 200 • Middleton, MA 01949
847.380.3540 • led-llc.com

LEDBarKit-Internal Driver (LBI)

FEATURES

The Linear Transformer is available in PRO version



9 SKUs in 1 WITH FLEXWATT™
& FLEXCOLOR™ TECHNOLOGY

flex:WATT	2FT	6W	9W	12W
	3FT	10W	12W	15W
	4FT	10W	15W	25W

- Eliminate ordering and stocking multiple wattages and color temperatures. Product offers 9 SKUs in 1 unit which can easily be configured to 3 different wattage packages and 3 different CCTs.

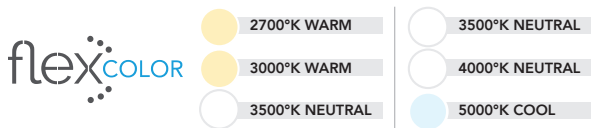

- Product ships at a default color temp (K) and wattage setting (install as is, or tailor the settings to fit your needs).
- Save on labor costs by having us factory pre-set the wattage and color temperature.

FLEXCONTROL™ TECHNOLOGY

- Order control ready or basic control (integrated high/low and daylight sensor) or advanced controls (such as, Philips Easy Sense, Avi-On Bluetooth or Lutron Vive).
- Optional sensors are directly linkable to the light bars.
- Our basic motion/daylight control (OC2 ordering code) is adjustable via remote control for (1) sensitivity (2) duration of time at high light level before dimming to low (3) duration of time at low light level before turning off (4) ramping up and down light levels based on daylight and (5) the dimmed light level %.

SUITABLE FOR DRY & DAMP LOCATIONS

PASS-THROUGH 0-10V DIMMING & AUXILIARY 12V OUTPUT

- Allows all light bars to be dimmed together as a group.

ADAPTABLE MOUNTING

- Various mounting clip options with integrated rare-earth magnets for easy placement in all style fixtures.
- High Bay pendant chain options available.

CONNECT UP TO 40 LIGHT BARS ON ONE INCOMING POWER CABLE (CHECK LINKING CHART FOR VOLTAGE SPECIFIC LINKING QUANTITY)

Up to 146 LUMENS PER WATT EFFICACY

10 YEAR WARRANTY, L70 >100,000HRS

OPTIONAL EMERGENCY BATTERY BACKUP

OPTIONAL BAA SECTION 1605

(If you require BAA (ARRA Section 1605) add -AA at end of part number.)



LIGHT EFFICIENT DESIGN HEADQUARTERS 188 S. Northwest Highway • Cary, IL 60013
INNOVATION & MANUFACTURING CENTER 30 Log Bridge Road, Building 200 • Middleton, MA 01949
847.380.3540 • led-llc.com

LEDBarKit-Internal Driver (LBI)

FLEXWATT + FLEXCOLOR

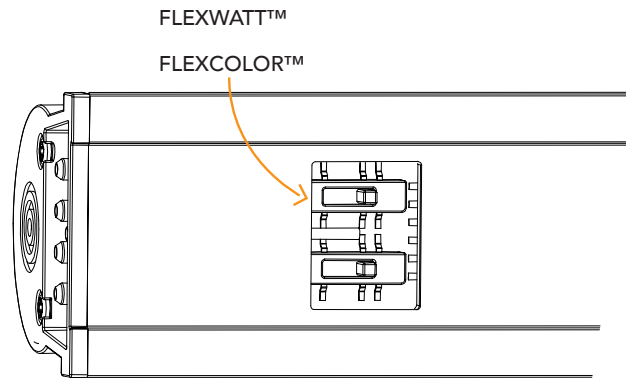

2FT	6W	9W	12W
3FT	10W	12W	15W
4FT	10W	15W	25W

HOW IT WORKS

Our exclusive LED driver is designed to operate at 90%+ efficiency at each wattage setting. Our competitor's drivers have much lower efficiency (as low as 60%) which results in poor performance and reduced efficacy.

WATTAGE CHOICES

2FT	6W	9W	12W
3FT	10W	12W	15W
4FT	10W	15W	25W

WATTAGE SELECTION

Adjust the 3-position slide switch, no tools required.



- 2700°K WARM
- 3000°K WARM
- 3500°K NEUTRAL

- 3500°K NEUTRAL
- 4000°K NEUTRAL
- 5000°K COOL

HOW IT WORKS

We select the highest efficacy, multiple color LED diodes from quality suppliers, and mount them on the circuit board. A proprietary LED binning process ensures color consistency between fixtures. The FlexColor technology ensures the desired color is selected, every time.

COLOR CHOICES

	FLEXCOLOR SLIDE SWITCH POSITION		
	TOP	MIDDLE	BOTTOM
... -27K-WC2	2700K	3000K	3500K
... -40K-WC	3500K	4000K	5000K

COLOR SELECTION

Adjust the 3-position slide switch, no tools required.



LIGHT EFFICIENT DESIGN HEADQUARTERS 188 S. Northwest Highway • Cary, IL 60013
 INNOVATION & MANUFACTURING CENTER 30 Log Bridge Road, Building 200 • Middleton, MA 01949
 847.380.3540 • led-llc.com

LEDBarKit-Internal Driver (LBI)

EXPLODED CONSTRUCTION VIEW

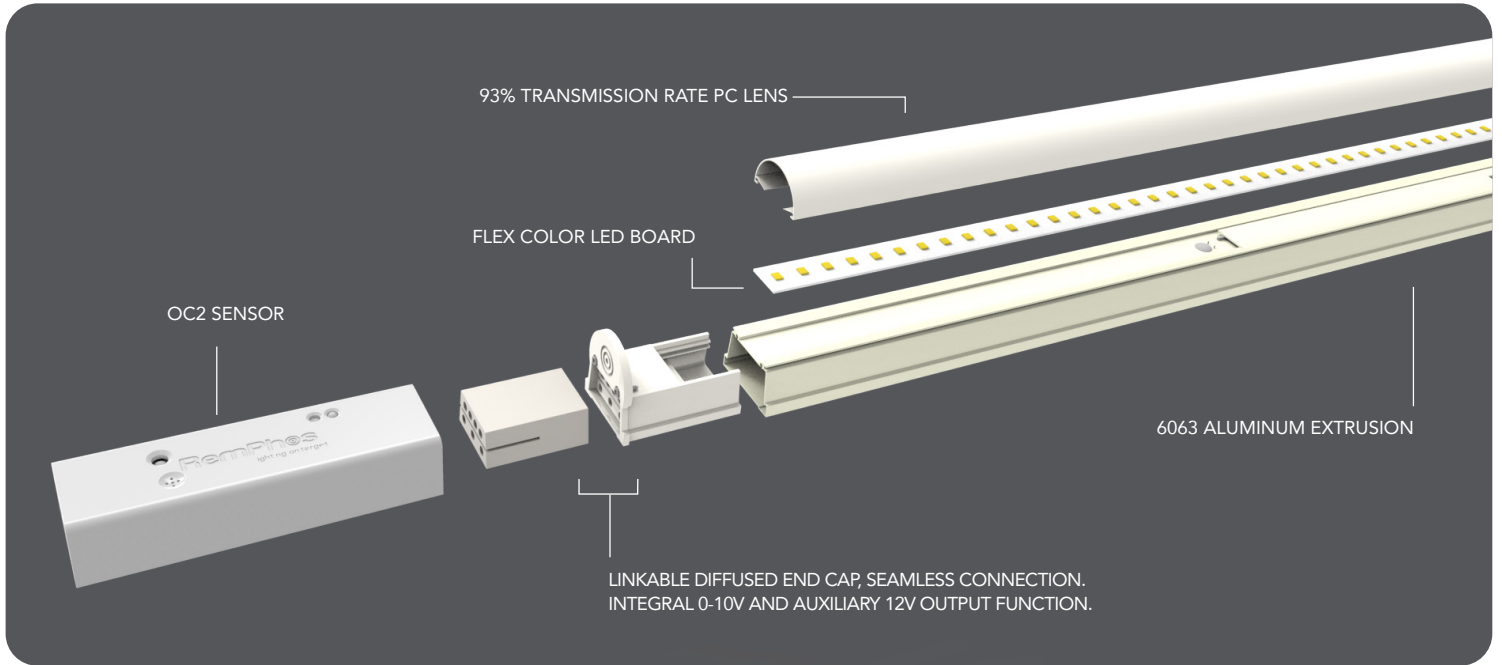

INCLUDED WITH EVERY BAR

2X Surface Mount Magnetic Clips
(w/ easy bend and break lines)

4X 1/4" hex head-self drilling screws



DIMENSIONS

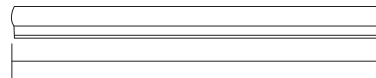

19.3"

RP-LBI-G1-2F-...

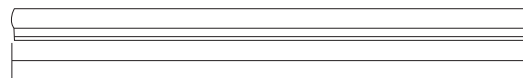

31.3"

RP-LBI-G1-3F-...

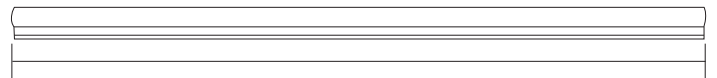

43.3"

RP-LBI-G1-4F-...

Cable Dimensions

7.25mm - 0.28 Inch for DIM cable.

6.35mm - .25 inch for NO-DIM cables

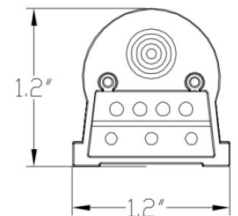
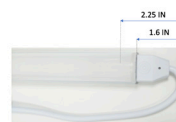
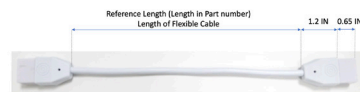

 **Light Efficient Design**

LIGHT EFFICIENT DESIGN HEADQUARTERS 188 S. Northwest Highway • Cary, IL 60013
INNOVATION & MANUFACTURING CENTER 30 Log Bridge Road, Building 200 • Middleton, MA 01949
847.380.3540 • led-llc.com

LEDBarKit-Internal Driver (LBI)

LINEAR AMBIENT

	PART #	DLC CODE	STANDARD/ PREMIUM	PRIMARY USE	# OF BARS	WATTAGE PER BAR	COLOR TEMP	TOTAL WATTAGE	TOTAL LUMENS
2FT	RP-LBI-G1-2F-6W-XXX-[WC,W]-[HV,Blank]-[Blank,OCN]-[Blank,BAA]	S-E4YHPK	Standard	Direct Linear Ambient Luminaires	1	6	35/40/50K	6	1419
	RP-LBI-G1-2F-6W-XXX-[WC,W]-[HV,Blank]-[Blank,OCN]-[Blank,BAA]	S-KI9ETC	Standard	Direct Linear Ambient Luminaires	1	6	27/30/35K	6	1394
	RP-LBI-G1-2F-9W-XXX-[WC,W]-[HV,Blank]-[Blank,OCN]-[Blank,BAA]	S-2WQ4GZ	Standard	Direct Linear Ambient Luminaires	1	9	35/40/50K	9	1419
	RP-LBI-G1-2F-9W-XXX-[WC,W]-[HV,Blank]-[Blank,OCN]-[Blank,BAA]	S-D5AI27	Standard	Direct Linear Ambient Luminaires	1	9	27/30/35K	9	1394
	RP-LBI-G1-2F-12W-XXX-[WC,W]-[HV,Blank]-[Blank,OCN]-[Blank,BAA]	S-5O1BQT	Standard	Direct Linear Ambient Luminaires	1	12	35/40/50K	12	1419
3FT	RP-LBI-G1-3F-10W-XXX-[WC,W]-[HV,Blank]-[Blank,OCN]-[Blank,BAA]	S-SAGNV4	Standard	Direct Linear Ambient Luminaires	1	10	35/40/50K	10	1961
	RP-LBI-G1-3F-10W-XXX-[WC,W]-[HV,Blank]-[Blank,OCN]-[Blank,BAA]	S-0A3PXW	Standard	Direct Linear Ambient Luminaires	1	10	27/30/35K	10	1842
	RP-LBI-G1-3F-12W-XXX-[WC,W]-[HV,Blank]-[Blank,OCN]-[Blank,BAA]	S-7HXUCZ	Standard	Direct Linear Ambient Luminaires	1	12	35/40/50K	12	1961
	RP-LBI-G1-3F-12W-XXX-[WC,W]-[HV,Blank]-[Blank,OCN]-[Blank,BAA]	S-M0PSAV	Standard	Direct Linear Ambient Luminaires	1	12	27/30/35K	12	1842
	RP-LBI-G1-3F-15W-XXX-[WC,W]-[HV,Blank]-[Blank,OCN]-[Blank,BAA]	S-B34TUU	Standard	Direct Linear Ambient Luminaires	1	15	35/40/50K	15	1961
	RP-LBI-G1-3F-15W-XXX-[WC,W]-[HV,Blank]-[Blank,OCN]-[Blank,BAA]	S-BVPFAT	Standard	Direct Linear Ambient Luminaires	1	15	27/30/35K	15	1842
	RP-LBI-G1-4F-10W-XXX-[WC,W]-[HV,Blank]-[Blank,OCN]-[BAA,Blank]-2xYYY	S-12GC94	Standard	Retrofit Kits for Direct Linear Ambient Luminaires	2	10	35/40/50K	20	6197
	RP-LBI-G1-4F-10W-XXX-[WC,W]-[HV,Blank]-[Blank,OCN]-[BAA,Blank]-3xYYY	S-QOGLP6	Standard	Retrofit Kits for Direct Linear Ambient Luminaires	3	10	35/40/50K	30	9292
	RP-LBI-G1-4F-10W-XXX-[WC,W]-[HV,Blank]-[Blank,OCN]-[Blank,BAA]	S-4J238A	Standard	Direct Linear Ambient Luminaires	1	10	35/40/50K	10	3166
	RP-LBI-G1-4F-10W-XXX-[WC,W]-[HV,Blank]-[Blank,OCN]-[BAA,Blank]-2xYYY	S-U5M1E5	Standard	Retrofit Kits for Direct Linear Ambient Luminaires	2	10	27/30/35K	20	5988
4FT	RP-LBI-G1-4F-10W-XXX-[WC,W]-[HV,Blank]-[Blank,OCN]-[BAA,Blank]-3xYYY	S-5H1OJ6	Standard	Retrofit Kits for Direct Linear Ambient Luminaires	3	10	27/30/35K	30	9046
	RP-LBI-G1-4F-10W-XXX-[WC,W]-[HV,Blank]-[Blank,OCN]-[Blank,BAA]	S-WBXZKE	Standard	Direct Linear Ambient Luminaires	1	10	27/30/35K	10	2989
	RP-LBI-G1-4F-15W-XXX-[WC,W]-[HV,Blank]-[Blank,OCN]-[BAA,Blank]-2xYYY	S-729L88	Standard	Retrofit Kits for Direct Linear Ambient Luminaires	2	15	35/40/50K	30	6197
	RP-LBI-G1-4F-15W-XXX-[WC,W]-[HV,Blank]-[Blank,OCN]-[BAA,Blank]-3xYYY	S-6HZX92	Standard	Retrofit Kits for Direct Linear Ambient Luminaires	3	15	35/40/50K	45	9292
	RP-LBI-G1-4F-15W-XXX-[WC,W]-[HV,Blank]-[Blank,OCN]-[Blank,BAA]	S-F0N516	Standard	Direct Linear Ambient Luminaires	1	15	35/40/50K	15	3166
	RP-LBI-G1-4F-15W-XXX-[WC,W]-[HV,Blank]-[Blank,OCN]-[BAA,Blank]-2xYYY	S-2NIW3X	Standard	Retrofit Kits for Direct Linear Ambient Luminaires	2	15	27/30/35K	30	5988
	RP-LBI-G1-4F-15W-XXX-[WC,W]-[HV,Blank]-[Blank,OCN]-[BAA,Blank]-3xYYY	S-IN462Q	Standard	Retrofit Kits for Direct Linear Ambient Luminaires	3	15	27/30/35K	45	9046
	RP-LBI-G1-4F-15W-XXX-[WC,W]-[HV,Blank]-[Blank,OCN]-[Blank,BAA]	S-11ZWG9	Standard	Direct Linear Ambient Luminaires	1	15	27/30/35K	15	2989
	RP-LBI-G1-4F-25W-XXX-[WC,W]-[HV,Blank]-[Blank,OCN]-[BAA,Blank]-2xYYY	S-86BDPE	Standard	Retrofit Kits for Direct Linear Ambient Luminaires	2	25	35/40/50K	50	6197
	RP-LBI-G1-4F-25W-XXX-[WC,W]-[HV,Blank]-[Blank,OCN]-[BAA,Blank]-3xYYY	S-A3LPKC	Standard	Retrofit Kits for Direct Linear Ambient Luminaires	3	25	35/40/50K	75	9292
	RP-LBI-G1-4F-25W-XXX-[WC,W]-[HV,Blank]-[Blank,OCN]-[Blank,BAA]	S-41DOBN	Standard	Direct Linear Ambient Luminaires	1	25	35/40/50K	25	3166
	RP-LBI-G1-4F-25W-XXX-[WC,W]-[HV,Blank]-[Blank,OCN]-[BAA,Blank]-2xYYY	S-AIYC2J	Standard	Retrofit Kits for Direct Linear Ambient Luminaires	2	25	27/30/35K	50	5988
	RP-LBI-G1-4F-25W-XXX-[WC,W]-[HV,Blank]-[Blank,OCN]-[BAA,Blank]-3xYYY	S-6TPCOV	Standard	Retrofit Kits for Direct Linear Ambient Luminaires	3	25	27/30/35K	75	9046
	RP-LBI-G1-4F-25W-XXX-[WC,W]-[HV,Blank]-[Blank,OCN]-[Blank,BAA]	S-PACK0N	Standard	Direct Linear Ambient Luminaires	1	25	27/30/35K	25	2989

LOW OUTPUT

	PART #	DLC CODE	STANDARD/ PREMIUM	PRIMARY USE	# OF BARS	WATTAGE PER BAR	COLOR TEMP	TOTAL WATTAGE	TOTAL LUMENS
2FT	RP-LBI-G1-2F-6W-XXX-[WC,W]-[HV,Blank]-[Blank,OCN]-[Blank,BAA]	S-ZW28LU	Premium	Stairwell and Passageway Luminaires	1	6	35/40/50K	6	1419
	RP-LBI-G1-2F-9W-XXX-[WC,W]-[HV,Blank]-[Blank,OCN]-[Blank,BAA]	S-9GJMU6	Premium	Stairwell and Passageway Luminaires	1	9	35/40/50K	9	1419
	RP-LBI-G1-2F-12W-XXX-[WC,W]-[HV,Blank]-[Blank,OCN]-[Blank,BAA]	S-JZTE4V	Premium	Stairwell and Passageway Luminaires	1	12	35/40/50K	12	1419
3FT	RP-LBI-G1-3F-10W-XXX-[WC,W]-[HV,Blank]-[Blank,OCN]-[Blank,BAA]	S-UJEG45	Premium	Stairwell and Passageway Luminaires	1	10	35/40/50K	10	1961
	RP-LBI-G1-3F-10W-XXX-[WC,W]-[HV,Blank]-[Blank,OCN]-[Blank,BAA]	S-7ZCIT5	Premium	Stairwell and Passageway Luminaires	1	10	27/30/35K	10	1842
	RP-LBI-G1-3F-12W-XXX-[WC,W]-[HV,Blank]-[Blank,OCN]-[Blank,BAA]	S-RBOCMU	Premium	Stairwell and Passageway Luminaires	1	12	35/40/50K	12	1961
	RP-LBI-G1-3F-12W-XXX-[WC,W]-[HV,Blank]-[Blank,OCN]-[Blank,BAA]	S-YZBHC	Premium	Stairwell and Passageway Luminaires	1	12	27/30/35K	12	1842
	RP-LBI-G1-3F-15W-XXX-[WC,W]-[HV,Blank]-[Blank,OCN]-[Blank,BAA]	S-KJ4BH	Premium	Stairwell and Passageway Luminaires	1	15	35/40/50K	15	1961
	RP-LBI-G1-3F-15W-XXX-[WC,W]-[HV,Blank]-[Blank,OCN]-[Blank,BAA]	S-OYXUA6	Premium	Stairwell and Passageway Luminaires	1	15	27/30/35K	15	1842
4FT	RP-LBI-G1-4F-10W-XXX-[WC,W]-[HV,Blank]-[Blank,OCN]-[Blank,BAA]	S-YSKB98	Premium	Stairwell and Passageway Luminaires	1	10	35/40/50K	10	3166
	RP-LBI-G1-4F-10W-XXX-[WC,W]-[HV,Blank]-[Blank,OCN]-[Blank,BAA]	S-ZD1UMN	Premium	Stairwell and Passageway Luminaires	1	10	27/30/35K	10	2989
	RP-LBI-G1-4F-15W-XXX-[WC,W]-[HV,Blank]-[Blank,OCN]-[Blank,BAA]	S-HFJ9E4	Premium	Stairwell and Passageway Luminaires	1	15	35/40/50K	15	3166
	RP-LBI-G1-4F-15W-XXX-[WC,W]-[HV,Blank]-[Blank,OCN]-[Blank,BAA]	S-YEJMDB	Premium	Stairwell and Passageway Luminaires	1	15	27/30/35K	15	2989
	RP-LBI-G1-4F-25W-XXX-[WC,W]-[HV,Blank]-[Blank,OCN]-[Blank,BAA]	S-SOODEU	Premium	Stairwell and Passageway Luminaires	1	25	35/40/50K	25	3166
RP-LBI-G1-4F-25W-XXX-[WC,W]-[HV,Blank]-[Blank,OCN]-[Blank,BAA]	S-VXWUK0	Premium	Stairwell and Passageway Luminaires	1	25	27/30/35K	25	2989	



LIGHT EFFICIENT DESIGN HEADQUARTERS 188 S. Northwest Highway • Cary, IL 60013
 INNOVATION & MANUFACTURING CENTER 30 Log Bridge Road, Building 200 • Middleton, MA 01949
 847.380.3540 • led-llc.com

LEDBarKit-Internal Driver (LBI)

PRODUCT SELECTION GUIDE (CONTINUED)

Default lumen package (wattage and CCT) are shown below in bold. There are two ways to achieve a non-default lumen package and/or CCT:
 1. You can easily adjust in field via our FlexWatt and FlexColor internal switches. 2. Have us adjust the FlexWatt and FlexColor at the factory for an additional charge.

LOW-BAY

PART #	DLC CODE	STANDARD/ PREMIUM	PRIMARY USE	# OF BARS	WATTAGE PER BAR	COLOR TEMP	TOTAL WATTAGE	TOTAL LUMENS
RP-LBI-G1-4F-10W-XXK-[WC,W]-[HV,blank]-[Blank,OCN]-[BAA,Blank]-2xYYY	S-1QKFA4	Standard	Low-Bay Luminaires for Commercial and Industrial Buildings	2	10	35/40/50K	20	6216
RP-LBI-G1-4F-10W-XXK-[WC,W]-[HV,blank]-[Blank,OCN]-[BAA,Blank]-2xYYY	S-UYKDG	Standard	Low-Bay Luminaires for Commercial and Industrial Buildings	2	10	27/30/35K	20	6005
RP-LBI-G1-4F-15W-XXK-[WC,W]-[HV,blank]-[Blank,OCN]-[BAA,Blank]-2xYYY	S-TOUZXD	Standard	Low-Bay Luminaires for Commercial and Industrial Buildings	2	15	35/40/50K	30	6216
RP-LBI-G1-4F-15W-XXK-[WC,W]-[HV,blank]-[Blank,OCN]-[BAA,Blank]-2xYYY	S-VXSZ8	Standard	Low-Bay Luminaires for Commercial and Industrial Buildings	2	15	27/30/35K	30	6005
RP-LBI-G1-4F-25W-XXK-[WC,W]-[HV,blank]-[Blank,OCN]-[BAA,Blank]-2xYYY	S-94HDWX	Standard	Low-Bay Luminaires for Commercial and Industrial Buildings	2	25	35/40/50K	50	6216
RP-LBI-G1-4F-25W-XXK-[WC,W]-[HV,blank]-[Blank,OCN]-[BAA,Blank]-2xYYY	S-XDOL53	Standard	Low-Bay Luminaires for Commercial and Industrial Buildings	2	25	27/30/35K	50	6005

HIGH-BAY

PART #	DLC CODE	STANDARD/ PREMIUM	PRIMARY USE	# OF BARS	WATTAGE PER BAR	COLOR TEMP	TOTAL WATTAGE	TOTAL LUMENS
RP-LBI-G1-4F-10W-XXK-[WC,W]-[HV,blank]-[Blank,OCN]-[BAA,Blank]-3xYYY	S-ESC4J9	Standard	High-Bay Luminaires for Commercial and Industrial Buildings	3	10	35/40/50K	30	9300
RP-LBI-G1-4F-10W-XXK-[WC,W]-[HV,blank]-[Blank,OCN]-[BAA,Blank]-3xYYY	S-ISYDE5	Standard	High-Bay Luminaires for Commercial and Industrial Buildings	3	10	27/30/35K	30	9149
RP-LBI-G1-4F-15W-XXK-[WC,W]-[HV,blank]-[Blank,OCN]-[BAA,Blank]-3xYYY	S-I9MO37	Standard	High-Bay Luminaires for Commercial and Industrial Buildings	3	15	35/40/50K	45	9300
RP-LBI-G1-4F-15W-XXK-[WC,W]-[HV,blank]-[Blank,OCN]-[BAA,Blank]-3xYYY	S-0CUKAJ	Standard	High-Bay Luminaires for Commercial and Industrial Buildings	3	15	27/30/35K	45	9149
RP-LBI-G1-4F-25W-XXK-[WC,W]-[HV,blank]-[Blank,OCN]-[BAA,Blank]-3xYYY	S-8XVKZO	Standard	High-Bay Luminaires for Commercial and Industrial Buildings	3	25	35/40/50K	75	9300
RP-LBI-G1-4F-25W-XXK-[WC,W]-[HV,blank]-[Blank,OCN]-[BAA,Blank]-3xYYY	S-UGMZ8Q	Standard	High-Bay Luminaires for Commercial and Industrial Buildings	3	25	27/30/35K	75	9149

LINKING QTY

	120V	208V	240V	277V
4FT	33 BARS	40 BARS	40 BARS	40 BARS
3FT	40 BARS	40 BARS	40 BARS	40 BARS
2FT	40 BARS	40 BARS	40 BARS	40 BARS

LINKING POSSIBILITIES

- ▶ Linking cables will lower connectable quantities.
- ▶ The Linking numbers are based on using the LBI Junction box and connected end to end.
- ▶ Linking does not include 0-10V linked control. This will depend on the controlling device.

To order for continuous runs, please order "1 Bar Kits" + required accessory connectors (sold separately).
 Connect up to 40 light bars on one incoming power cable. (Check linking chart for voltage specific linking quantity)

STAIRWELL FIXTURE

PART #	UPC	DESCRIPTION	WATTAGE	LUMENS	LPW	CCT
RP-LBI-G1-2F-12W-40K-W-OC2	844006024505	2FT INTERNAL DRIVE LIGHT BAR STAIRWELL KIT	12	1560	130	4000
RP-LBI-G1-4F-15W-40K-W-OC2	844006024512	4FT INTERNAL DRIVE LIGHT BAR STAIRWELL KIT	15	2055	137	4000

Kit comes with 1X light Bar + OC2 Motion Sensor Kit.



LIGHT EFFICIENT DESIGN HEADQUARTERS 188 S. Northwest Highway • Cary, IL 60013
 INNOVATION & MANUFACTURING CENTER 30 Log Bridge Road, Building 200 • Middleton, MA 01949
 847.380.3540 • led-llc.com

—○ LEDBarKit-Internal Driver (LBI)

APPLICATION TABLE OF CONTENTS

PARTS & ACCESSORIES	PAGE 13-14
RETROFIT TROFFERS	PAGE 16
RETROFIT LINEAR FIXTURES	PAGE 17
CONTINUOUS RUN FIXTURES / RETROFIT	PAGE 18
HIGH BAY FIXTURE / RETROFIT	PAGE 19
STAIRWELL FIXTURE KIT / UTILITY FIXTURE.....	PAGE 20

IMPORTANT NOTE ON WIRING METHOD

As you will see on the following pages, there are many possible uses for The Linear Transformer. If your application calls for multiple light bars in a single fixture, there are 2 possible ways to order and wire (see below).

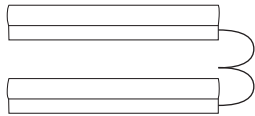

PARALLEL

Multiple incoming power cables can be grouped together under the ballast cover to make connection to incoming power and controls.

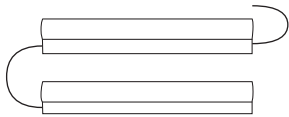

SERIES (WITH LINKING CABLE)

This method is the fastest. The first light bar uses an incoming power cable, additional light bars are linked using "linking cables" which are available in a variety of lengths. Linking cables are sold separately.

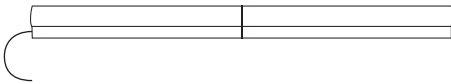

SERIES (WITH SEAMLESS CONNECTOR)

This method provides a near seamless appearance between the bars. The first light bar uses an incoming power cable, additional light bars are linked using "seamless connectors" which are sold separately.



RP-LBI-EMG1-25W (SINGLE FLEX)

RP-LBI-EMG2-25W (DUAL FLEX)

PRODUCT DESCRIPTION

The EMG-H Series LED emergency drivers are UL Listed for factory or field installation, unrivaled emergency solutions for LED product with internal driver. It allows the same LED luminaire to be used for normal and emergency operation and works in conjunction with an AC LED driver that convert new or existing LED fixtures into emergency lighting. It includes a long-life recyclable Lithium battery, and is backed by a 5-Year Warranty.

OPERATION

When AC power fails, The EM-H Series emergency LED driver immediately switches to the emergency mode, operating the LEDs at full lumen output for a minimum of 90 minutes (25W max load). When AC power is restored, the emergency driver automatically returns to the charging mode.

FEATURES

1. Long life recyclable Lithium battery.
2. Integration of test switch and charge indicator.
3. Used for exterior or interior of luminaire.
4. The power of LED luminaire < power of emergency driver.

MOUNTING CONFIGURATION:

RP-LBI-EMG1-25W Single Flex (Standard Version)

Mounts to the junction box and provides flexible conduit for remote mounting of the test accessories.

RP-LBI-EMG2-25W Dual Flex (Optional)

Provides dual flex for wiring to both fixture or driver compartment and test accessories



TYPICAL WIRING DIAGRAM

(Must connect DIM circuit from EM unit to LBI)

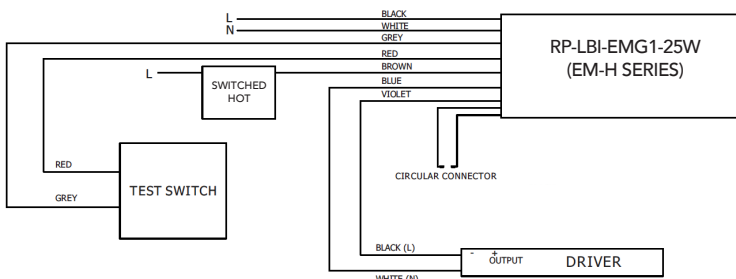

EM-H Series

UL Listed LED Emergency Driver

Unrivaled emergency solutions for LED Products with Internal drivers



DIMENSIONS

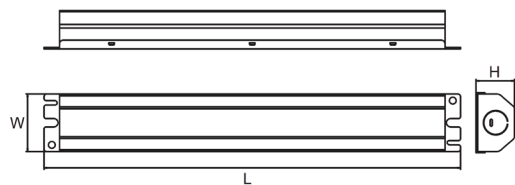

MODEL	L	W	H
EM-H25170-XX	17.14"	2.13"	1.57"

RP-LBI-EMG1-25W (EM-H25170-XX)



- Output Power**
25 Watts (Max Load)
- Output Voltage**
170V DC
- Input Current**
60 mA (Max)
- Input Power**
8 Watts (Max)
- Input Voltage**
120-277VAC, 50-60Hz
- Emergency Operation**
>90 Minutes
- Operating Temp**
0° to 50°C
- Battery**
Lithium
- Recharge**
36 Hrs
- Dimensions**
L 17.14' X W 2.13" X H 1.57"



RP-LBI-EMG2-8W-DIM (LINKABLE UP TO 100W OF LBI)

RP-LBI-EMG2-25W-DIM (LINKABLE UP TO 300W OF LBI)

PRODUCT DESCRIPTION

The EMG-H Series LED emergency drivers are UL Listed for factory or field installation, unrivaled emergency solutions for LED product with Internal driver. It allows the same LED luminaire to be used for normal and emergency operation and works in conjunction with an AC LED driver that convert new or existing LED fixtures into emergency lighting. It includes a long-life recyclable Lithium battery, and is backed by a 5-Year Warranty.

INSTALLATION

The Emergency Back up will dim the connected fixtures down to a level where they will run without line voltage for 90Min. For fixtures that are connected to a wall dimmer the Emergency Back up will override the current dim setting and provide the maximum illumination possible at the selected wattage for 90Min.

How many fixtures can be connected? This is determined by the "maximum luminaire power load" listed for each respective back up wattage that we offer. The Luminaire power load is referencing the amount of power the fixture or fixtures consume. This is selected by the FLEX WATT setting of each fixture. When using multiple fixtures, the wattages are added together to get the total power load. For example, if the 4FT PRO LBI is being used, it has a maximum wattage setting of 25W, that means a maximum of 4 fixtures can be attached to the 8W emergency backup and a maximum of 12 fixtures can be used with the 25W back up version. For another example, if a single 4FT PRO LBI set at the highest wattage setting is attached to the 25W back up it will output full brightness for 90Min.

OPERATION

When AC power fails, The EM-H Series emergency LED driver immediately switches to the emergency mode for a minimum of 90 minutes. When AC power is restored, the emergency driver automatically returns to the charging mode.

FEATURES

1. Long life recyclable Lithium battery.
2. Integration of test switch and charge indicator.
3. Used for exterior or interior of luminaire.
4. 8W version, load up to 100W w/dim control 25W version, load up to 300W w/dim control

MOUNTING CONFIGURATION: DUAL FLEX

RP-LBI-EMG2-8W-DIM

RP-LBI-EMG2-25W-DIM

Mounts to the junction box and provides flexible conduit for remote mounting of the test accessories.



TYPICAL WIRING DIAGRAM

(Must connect DIM circuit from EM unit to LBI)

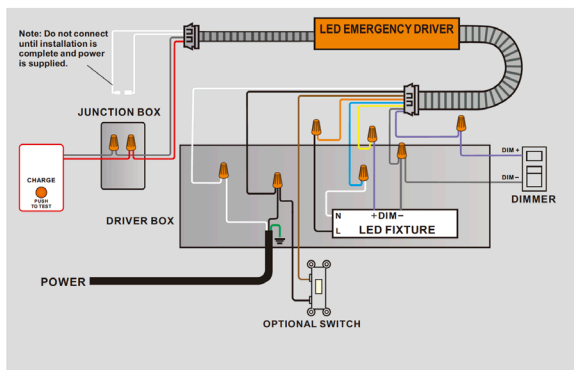

EM-H Series

UL Listed LED Emergency Driver

Unrivaled emergency solutions for LED Products with Internal drivers

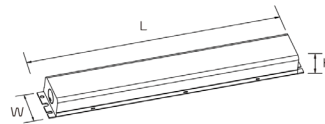

MODEL	L	W	H
RP-LBI-EMG2-8W-DIM	12.76"	2.13"	1.57"
RP-LBI-EMG2-25W-DIM	15.40"	2.13"	1.57"

RP-LBI-EMG2-8W-DIM

(EM-H08170-LBF)

Output Power

8 Watts

Output Voltage

170V DC

Input Current

70 mA (Max)

Input Power

3.2 Watts (Max)

Input Volatage

100-277VAC, 50-60Hz

Emergency Operation

>90 Minutes

Operating Temp

0° to 50°C

Battery

Lithium

Recharge

24 Hrs

Luminaire Load Power

100W (Max)

Certificates

UL , CEC

RP-LBI-EMG2-25W-DIM

(EM-H25170-LBF)

Output Power

25 Watts

Output Voltage

170V DC

Input Current

110 mA (Max)

Input Power

6 Watts (Max)

Input Volatage

120-277VAC, 50-60Hz

Emergency Operation

>90 Minutes

Operating Temp

0° to 50°C

Battery

Lithium

Recharge

36 Hrs

Luminaire Load Power

300W (Max)

Certificates

UL , CEC



Light Efficient Design

LEDBarKit-Internal Driver (LBI)

PARTS & ACCESSORIES

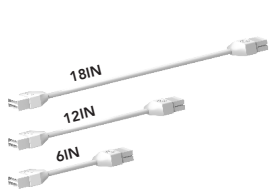

LINKING CABLES

RP-LBI-LC-6IN-DIM-10P
RP-LBI-LC-6IN-NODIM-10P
RP-LBI-LC-12IN-DIM-10P
RP-LBI-LC-12IN-NODIM-10P
RP-LBI-LC-18IN-DIM-10P
RP-LBI-LC-18IN-NODIM-10P

INCOMING POWER KIT: RP-LBI-G1-IP-3F-DIM

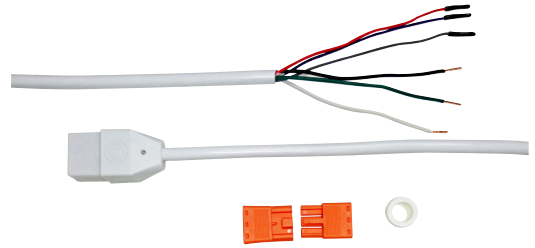

DIM



SEAMLESS CONNECTOR

RP-LBI-SSC-DIM-10P
RP-LBI-SSC-NODIM-10P

NO-DIM



LINKING CABLES & SEAMLESS CONNECTORS

Use Linking Cables and Seamless Connectors to easily connect the power and control wires from one light bar to another. The ...-DIM version of the linking cables and seamless connector link all connections (AC power; 12V Aux power; 0-10V DIM signal) from light bar to light bar. Use these items to control all light bars from one sensor or incoming cable connection. The ...-NODIM version of these items only links the AC power. Use these items to AC power all light bars with a single power feed; but separate control signals into individual groups.



4.7IN SPACER CONNECTOR | RP-LBI-SRC-4.7IN (SINGLE PACK)

Use the 4.7in Spacer Connector to bring the length of the bar system to a standard dimension (24in, 36in, 48in). This is useful when retrofitting linear fixtures of a standard length. It allows for the bar to be centered on each standard-length fixture. Each 4.7in spacer connector comes with (2) Seamless Connector-DIM.

***Note: spacer does not emit light**



SENSOR KITS | RP-LBI-OC2-A (STANDARD RANGE - SINGLE PACK) RP-LBI-OC3-A_LR (LIMITED RANGE - SINGLE PACK)

Sensors kits for LBI are Tri-Level, remote controllable high frequency radar sensor designed to easily integrate with the LBI bars. It is totally plug&play! It can dim the light bars down to conserve more energy from both motion and daylight. The sensor controls the 0-10V DIM signal in both directions from the Sensor unit. Each sensor kit comes with (1) sensor (4.7 inch); (1) surface mount magnetic clip; (2) Seamless Connector-DIM; (1) 12" Linking Cable-DIM. See [RP-LBI-OC2-A/OC3-A](#) data sheet for more details.



SURFACE MOUNT MAGNETIC CLIP | RP-LBI-SMM-10P (10 PACK ONLY)

The Surface Mount Magnetic Clip provides the most universal method for attaching the light bar to a wall, ceiling, or fixture to be retrofitted. The mounting tabs that extend perpendicularly from the light bar can be easily removed by bending and breaking on the pre-scored line. The strong rare-earth magnets are intended to hold light bars in place while installing mechanical fasteners. Not intended for permanent installation with magnets only.

Two of these clips are included in each light bar kit.



SUSPENDED IN-LINE KIT | RP-LBI-SIL-KIT-10P (10 PACK ONLY)

The Suspended In-Line Kit includes everything needed to suspend LBI from the ceiling.

The complete kit includes: Suspended In-Line Bracket, Aircraft Cable (9.8ft), Adjustable cable gripper, and a ceiling anchor.



SUSPENDED IN-LINE BRACKET (*BRACKET ONLY*) | RP-LBI-SIL-BRACKET-10P (10 PACK ONLY)

The Suspended In-Line Bracket (bracket only) is a wide clip that fastens over the junction between 2 LBI light bars to keep them straight in-line and provides mounting points for common suspension methods (air craft cable, drop chain, etc.) This part number is for the bracket only.



—○ LEDBarKit-Internal Driver (LBI)

PARTS & ACCESSORIES

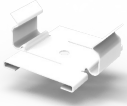

T-BAR CLIPS | RP-LBI-T1516-10P (PARALLEL – DIRECTLY UNDER THE T-BAR – 10 PACK)
RP-LBI-T1516-90-10P (PERPENDICULAR – ACROSS THE BAR – 10 PACK)

The T-Bar Clips is the fastest way to mount a light bar to a T-Bar grid ceiling. Works with standard 15/16" grid only.



BLADE CLIP | RP-LBI-BLC-10P (10 PACK ONLY)

The Blade Clip is designed to provide a retrofit solution for fixtures that have thin sheet metal or plastic film reflectors commonly found on high bay fixtures. The rotating mounting blade provides a degree of freedom to align the mounting holes on the blade with fastening locations that may not be in-line with the light bar or where the distance between available mounting points is greater than the length of the light bar. It is common to attach the blade to the same point holding the thin reflector to the fixture frame.



UP DOWN CLIP | RP-LBI-UDC-10P (10 PACK ONLY)

Use the Up/Down clip with our suspended in-line kit to clip a shorter bar to provide up-light. For example if suspending a 4ft, use the 3ft OR 2ft as the up-light, (so there is room for the suspension-kit connection). The RP-LBI-SIL-KIT comes with wire clips to hold linking power cable for UP bars in-line and neat. (linking cable not included)



LBI JUNCTION BOX | RP-LBI-JBOX-1.5X4

The LBI junction box is used to connect LBI wiring to branch circuits. Connections are made from the LBI Junction box to the Light Bar using seamless connector or linking cable. The internal wiring (except optional switch) are rated to 600V (for 347V operation) For undercabinet or task lighting, the junction box includes an optional 120V ON/OFF switch that can be installed into a rectangular knock-out on the cover. Kit includes 1pc RP-LBI-SSC-DIM.



12FT 90-DEGREE INCOMING POWER CABLE | RP-LBI-G1-IP-90DEG-12F-DIM

Use the 90 degree Incoming Power Cable for an easy and clean connection to suspended LBI fixtures.



OUTPUT CAP | RP-LBI-G2-OUTPUT-CAP-10P

Male power and control termination plug for the LBI linking connector 10 pack.



LEDBarKit-Internal Driver (LBI)

SUSPENDED IN LINE KIT*



*Linking cable not included in Suspended In Line Kit

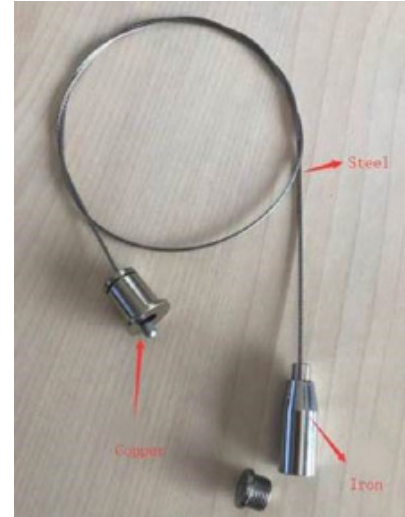

RECOMMENDED INSTALLATION

CONTINUOUS RUN

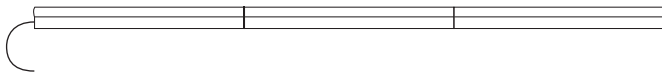

CONTINUOUS RUN WITH OPTIONAL OC2 SENSOR KIT

OC2 Sensor can be installed on either end or in between any bars

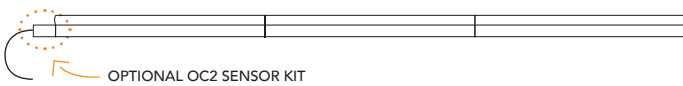

OPTIONAL OC2 SENSOR KIT



OPTIONAL OC2 SENSOR KIT

CONTINUOUS RUN WITH SPACER CONNECT

Ideal for retrofitting fixtures of standard length

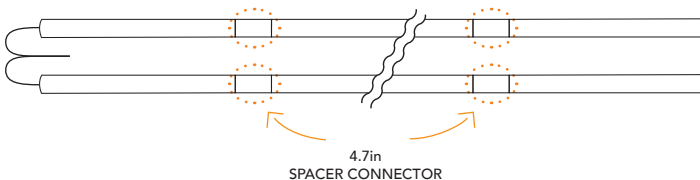

4.7in
SPACER CONNECTOR

DIMENSIONS

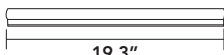

19.3"

RP-LBI-G1-2F-...

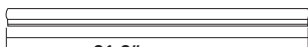

31.3"

RP-LBI-G1-3F-...

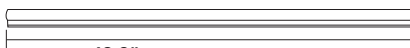

43.3"

RP-LBI-G1-4F-...

*When calculating continuous run, note that actual lengths are less than what is stated in the part number.

ACCESSORIES



SEAMLESS CONNECTOR*

RP-LBI-SSC-DIM (sold separately)

Links the OCC control signal to all bars.

RP-LBI-SSC-NODIM (sold separately)

Isolates each OCC control group within the continuous run.

*All continuous run installations require seamless connectors.



SUSPENDED IN-LINE BRACKET KIT

RP-LBI-SIL (sold separately)

Recommended qty = number of bars + 1

12FT 90-DEGREE INCOMING POWER CABLE

RP-LBI-G1-IP-90DEG-12F-DIM

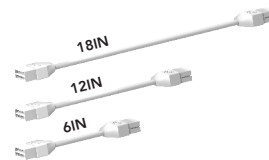

LINKING CABLES*

RP-LBI-LC-6IN-DIM

RP-LBI-LC-6IN-NODIM

RP-LBI-LC-12IN-DIM

RP-LBI-LC-12IN-NODIM

RP-LBI-LC-18IN-DIM

RP-LBI-LC-18IN-NODIM

* Choose the appropriate linking cable length based on the dimensions of your fixture.



LIGHT EFFICIENT DESIGN HEADQUARTERS 188 S. Northwest Highway • Cary, IL 60013
INNOVATION & MANUFACTURING CENTER 30 Log Bridge Road, Building 200 • Middleton, MA 01949
847.380.3540 • led-llc.com

LEDBarKit-Internal Driver (LBI)

RETROFIT TROFFERS*

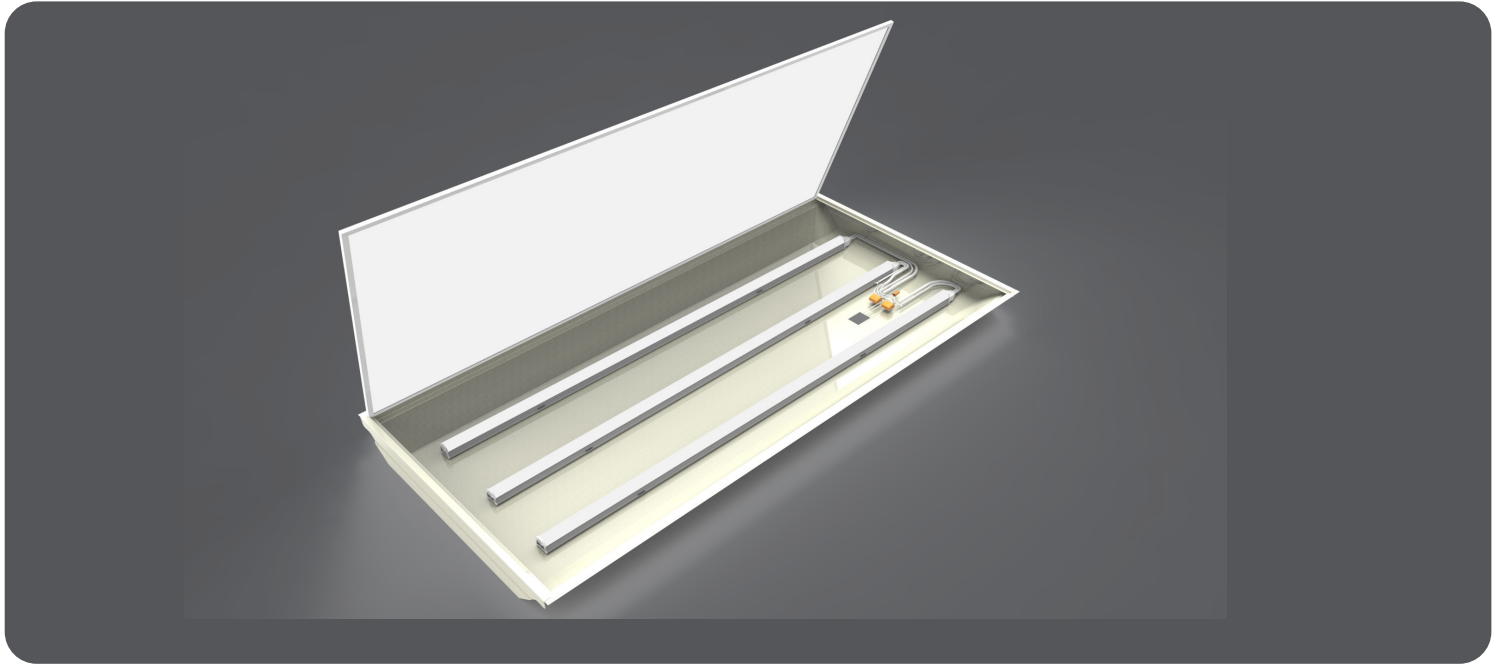

RECOMMENDED INSTALLATION

ACCESSORIES

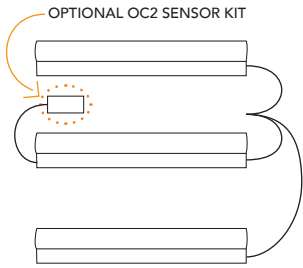

PARALLEL

This method is the most cost effective. Each light bar comes with its own incoming power cable. Multiple incoming power cables are connected together under the ballast cover.

INCOMING POWER CABLES

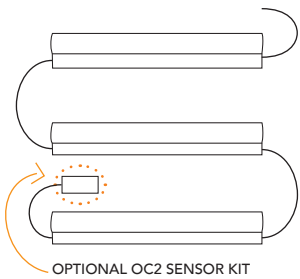
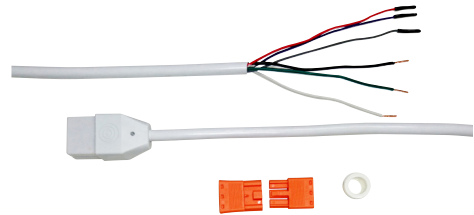

SERIES

This method is the fastest. The first light bar uses an incoming power cable, additional light bars are linked using "linking cables" which are available in a variety of lengths. Linking cables are sold separately.

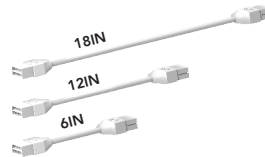

LINKING CABLES*

- RP-LBI-LC-6IN-DIM
- RP-LBI-LC-6IN-NODIM
- RP-LBI-LC-12IN-DIM
- RP-LBI-LC-12IN-NODIM
- RP-LBI-LC-18IN-DIM
- RP-LBI-LC-18IN-NODIM

* Choose the appropriate linking cable length based on the dimensions of your fixture.



LEDBarKit-Internal Driver (LBI)

RETROFIT LINEAR FIXTURES *

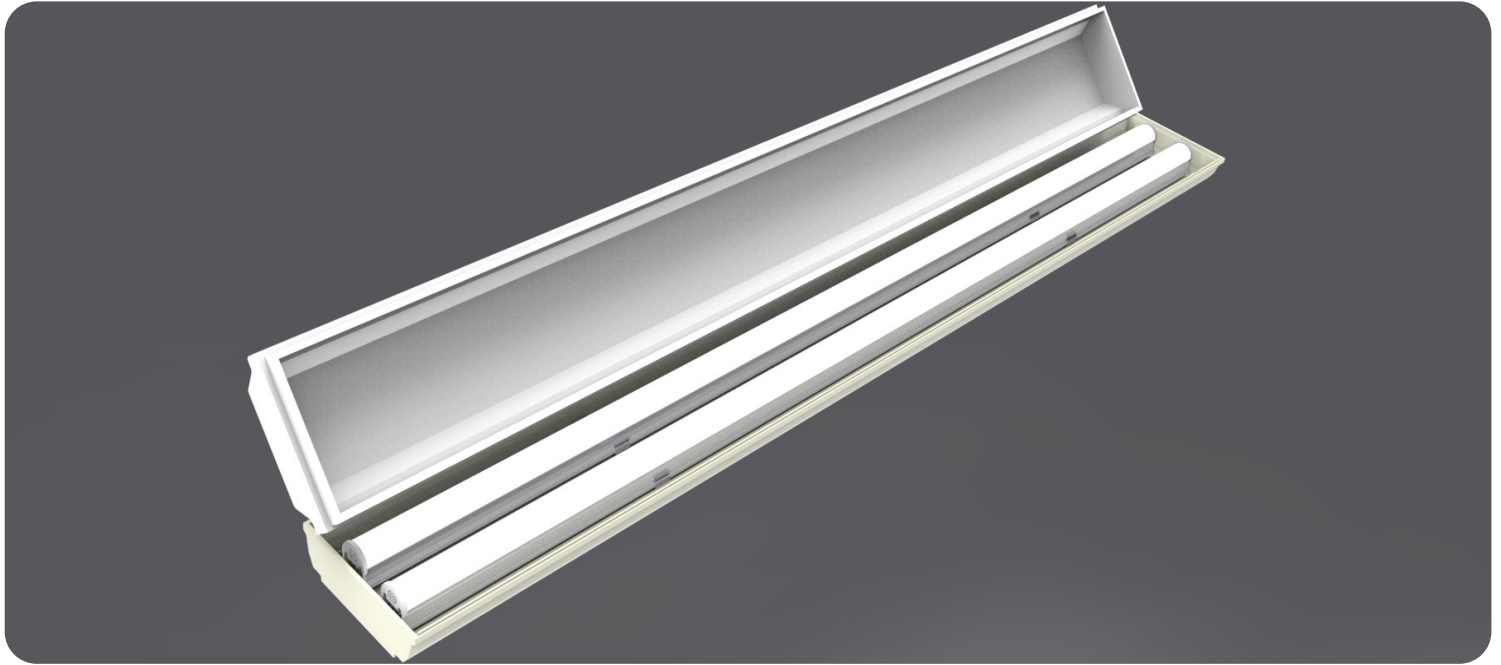

* Example Retrofit. Fixture not included.

RECOMMENDED INSTALLATION

PARALLEL

Multiple incoming power cables are connected together under the ballast cover.

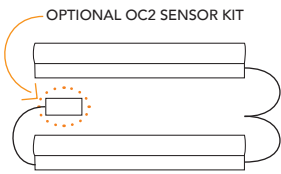

ACCESSORIES

INCOMING POWER CABLES

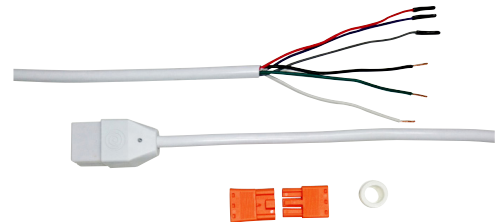

SERIES

This method is the fastest. The first light bar uses an incoming power cable, additional light bars are linked using "linking cables" which are available in a variety of lengths.

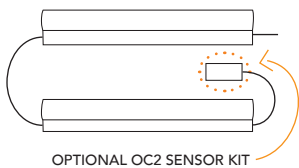

LINKING CABLES*

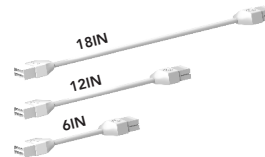

- RP-LBI-LC-6IN-DIM
- RP-LBI-LC-6IN-NODIM
- RP-LBI-LC-12IN-DIM
- RP-LBI-LC-12IN-NODIM
- RP-LBI-LC-18IN-DIM
- RP-LBI-LC-18IN-NODIM

* Choose the appropriate linking cable length based on the dimensions of your fixture.



LEDBarKit-Internal Driver (LBI)

CONTINUOUS RUN FIXTURES / RETROFIT*

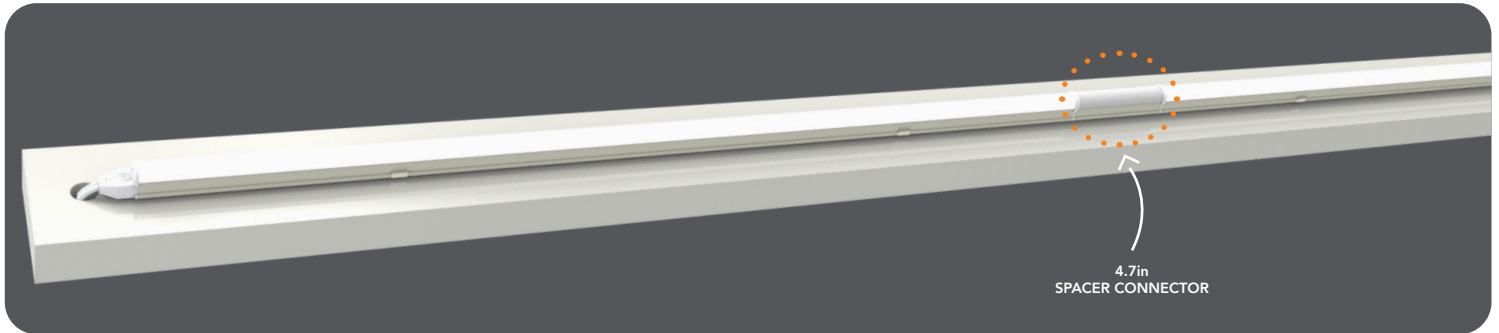
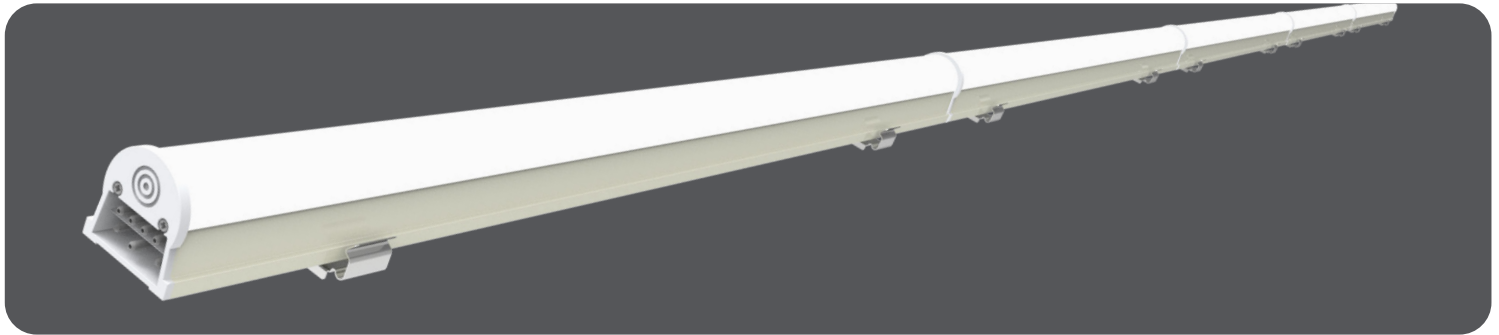

* Example Retrofit. Fixture not included.

RECOMMENDED INSTALLATION

CONTINUOUS RUN

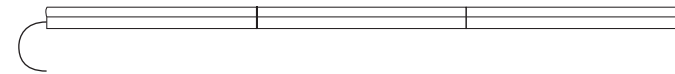

CONTINUOUS RUN WITH OPTIONAL OC2 SENSOR KIT

OC2 Sensor can be installed on either end or in between any bars

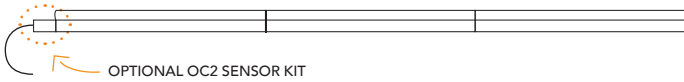

CONTINUOUS RUN WITH SPACER CONNECT

Ideal for retrofitting fixtures of standard length

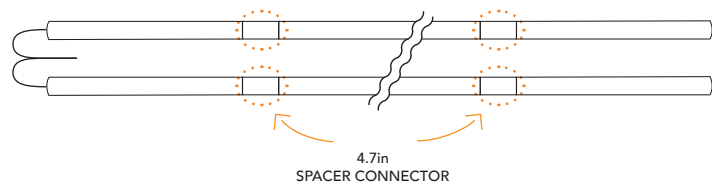

DIMENSIONS

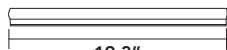

19.3"

RP-LBI-G1-2F-...

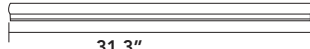

31.3"

RP-LBI-G1-3F-...

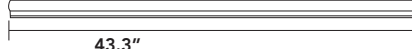

43.3"

RP-LBI-G1-4F-...

*When calculating continuous run, note that actual lengths are less than what is stated in the part number.

ACCESSORIES

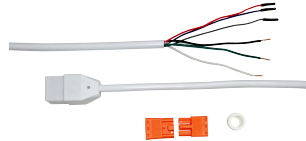

*Connect up to 40 units on one incoming power cable (Check linking chart for voltage specific linking quantity)

INCOMING POWER CABLES



LIGHT EFFICIENT DESIGN HEADQUARTERS 188 S. Northwest Highway • Cary, IL 60013
 INNOVATION & MANUFACTURING CENTER 30 Log Bridge Road, Building 200 • Middleton, MA 01949
 847.380.3540 • led-llc.com

LEDBarKit-Internal Driver (LBI)

HIGH BAY FIXTURE / RETROFIT*

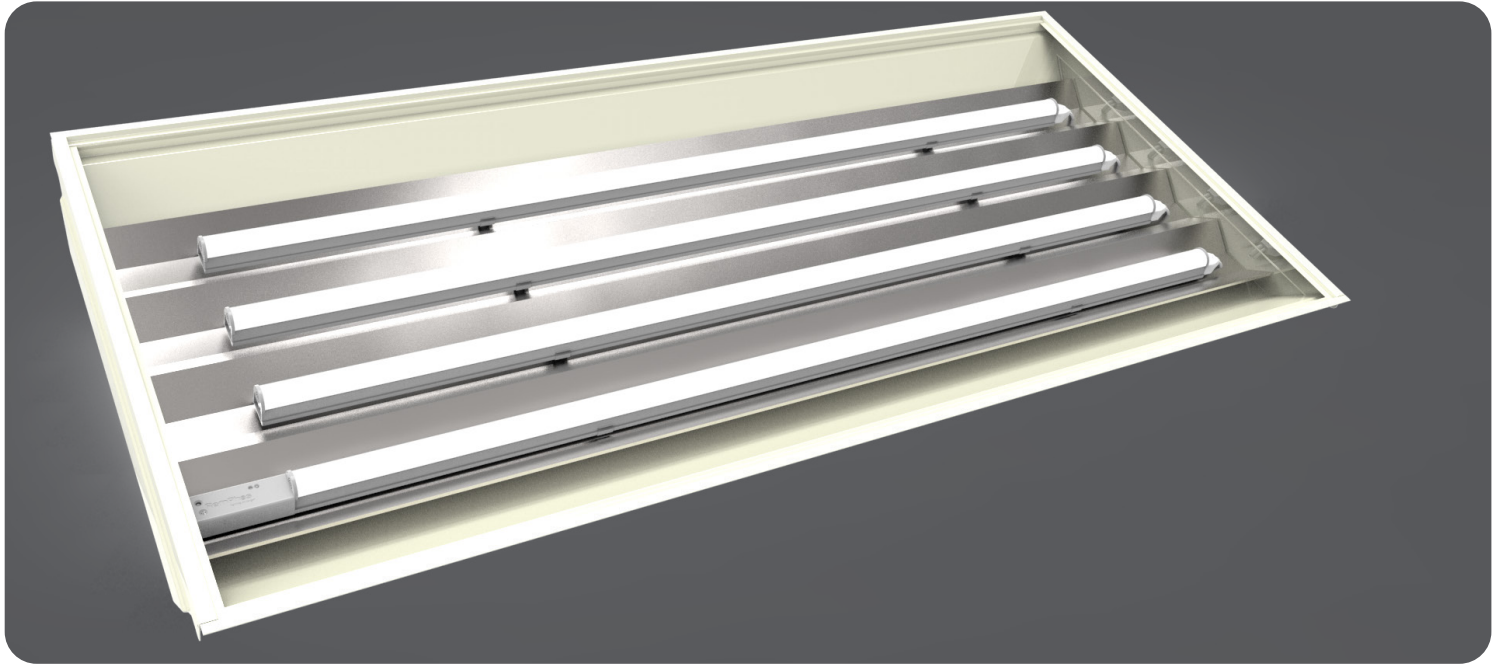

* Example Retrofit. Fixture not included.

RECOMMENDED INSTALLATION

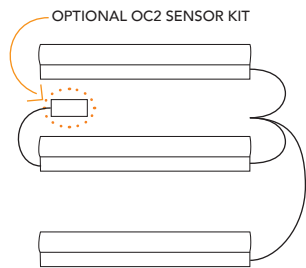

PARALLEL

This method is the most cost effective. Each light bar comes with its own incoming power cable. Multiple incoming power cables are connected together under the ballast cover.

ACCESSORIES

BLADE CLIP

RP-LBI-BLC-10P

The Blade Clip is designed to provide a retrofit solution for fixtures that have thin sheet metal or plastic film reflectors commonly found on high bay fixtures. It is common to attach the blade to the same point holding the thin reflector to the fixture frame.

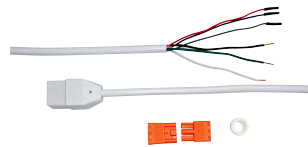

INCOMING POWER CABLES

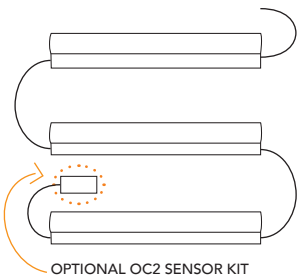

SERIES

This method is the fastest. The first light bar uses an incoming power cable, additional light bars are linked using "linking cables" which are available in a variety of lengths. Linking cables are sold separately.

LINKING CABLES*

- RP-LBI-LC-6IN-DIM
- RP-LBI-LC-6IN-NODIM
- RP-LBI-LC-12IN-DIM
- RP-LBI-LC-12IN-NODIM
- RP-LBI-LC-18IN-DIM
- RP-LBI-LC-18IN-NODIM

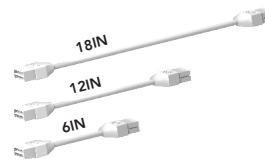

* Choose the appropriate linking cable length based on the dimensions of your fixture.

You can choose to purchase Light Bars only and hang/mount as a standalone fixture or retrofit an existing high bay fixture housing as shown above.



LIGHT EFFICIENT DESIGN HEADQUARTERS 188 S. Northwest Highway • Cary, IL 60013
 INNOVATION & MANUFACTURING CENTER 30 Log Bridge Road, Building 200 • Middleton, MA 01949
 847.380.3540 • led-llc.com

LEDBarKit-Internal Driver (LBI)

STAIRWELL FIXTURE KIT / UTILITY FIXTURE*

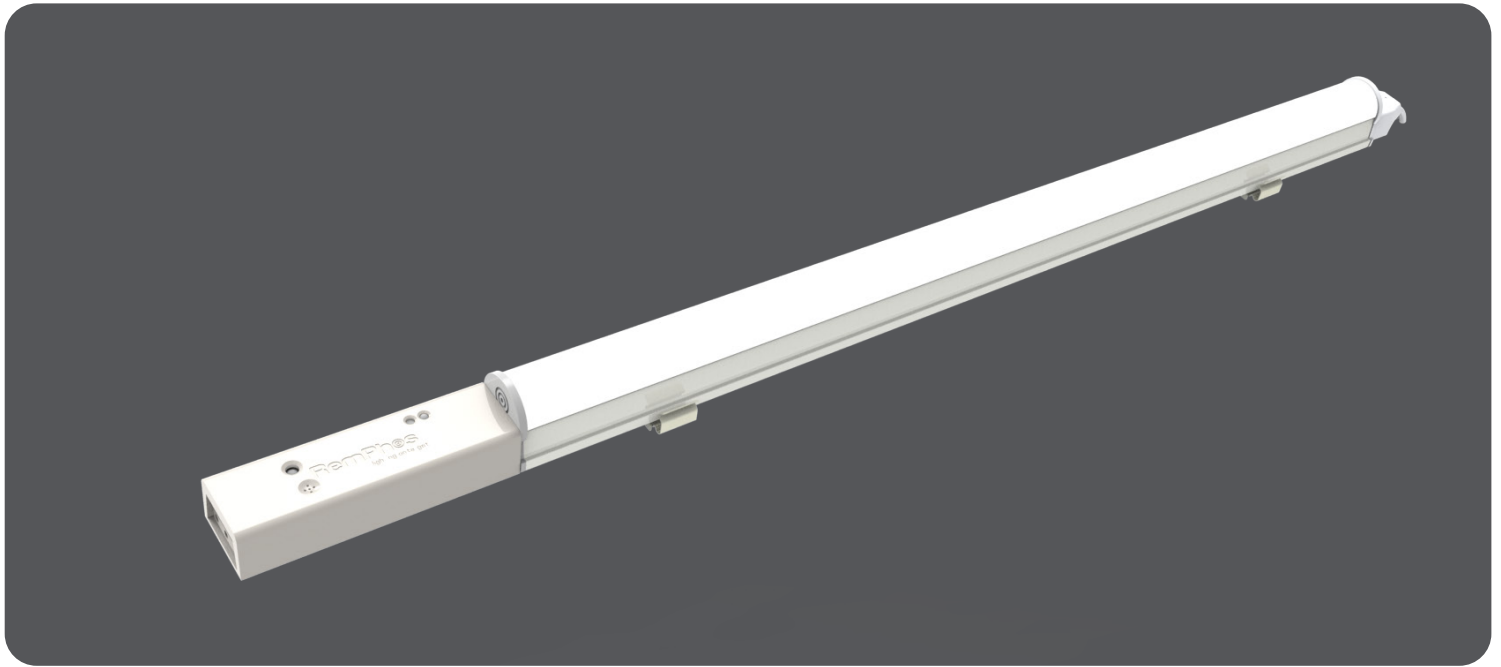

* Example Retrofit. Fixture not included.

STAIRWELL FIXTURE KIT INCLUDES



ORDERING

2FT: RP-LBI-2F-12W-40K-W-OC2
4FT: RP-LBI-4F-15W-40K-W-OC2

1 - INCOMING POWER CABLE

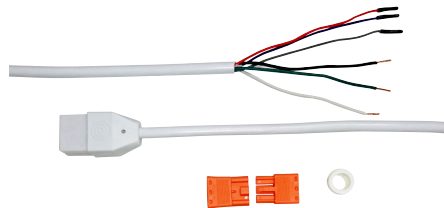

1 - OC2 SENSOR KIT

RP-LBI-OC2
Sensor + Seamless Connector-DIM

UTILITY FIXTURE

To use as a standalone utility fixture, purchase 1X Light Bar kit and 1X incoming power cable kit.

Fixture housings to be used as wiring and emergency battery compartment currently in development. Call for more information.



LIGHT EFFICIENT DESIGN HEADQUARTERS 188 S. Northwest Highway • Cary, IL 60013
INNOVATION & MANUFACTURING CENTER 30 Log Bridge Road, Building 200 • Middleton, MA 01949
847.380.3540 • led-llc.com

RP-LBI-OC2 SENSOR KIT FOR LEDBARKIT - INTERNAL DRIVER (LBI)

Remote Control Settings

If satisfied with OC2 default settings, remote control is not needed. If settings need to be changed, optional remote control (RP-OC2-REMOTE-IR11), is required.



PERMANENT ON FUNCTION

Press 'ON' button, fixture goes to permanent on mode, sensor is disabled. With memory function against power failure.

* Press 'Auto' or 'Reset' to quit this mode.



PERMANENT OFF FUNCTION

Press 'OFF' button, fixture goes to permanent off mode, sensor is disabled.

* Press 'Auto' or 'Reset' learn' to quit this mode.



SENSOR MODE

Press 'Auto' button, the sensor starts to work and all settings remain the same as the latest status before the light was switched on/off.



RESET FUNCTION

Press 'Reset' button, all settings go back to factory default settings.

FACTORY DEFAULT SETTINGS - REMOTE REQUIRED TO CHANGE SETTINGS

- Sensitivity=50%
- Daylight sensor=disable
- Hold time=5min
- Twilight time=+∞
- Twilight level=30%

NOTE daylight harvest function is disabled in factory default mode. Choose the appropriate lux threshold first to activate the daylight harvest function.



DISABLE DAYLIGHT SENSOR

Press 'Disable' button, the daylight sensor will be disabled, the motion sensor will work always, even in daytime.



TEST MODE

'Test mode' is used for testing purpose only, for users to check the the desired detection range.

Quit test mode by pressing any other button of 'Hold time'. The sensor settings are changed accordingly.

TEST MODE SETTINGS

- Daylight sensor=disable
- Hold time=3s
- Twilight time=N/A
- Twilight level=N/A



IR11

- The buzzer short beeps (~0.5s) ONCE when sensor successfully receives RC signal after pressing any button.
- When "twilight level" set at 0%, it becomes ON/OFF control.
- The sensor controls the LBI fixtures w/ 0-10V inputs. Even if on/off only function is desired, the OC2 sensor is only compatible w/ PRO series LBI products.

