

INSTALLATION INSTRUCTIONS

FOR RECESSED EDGE-LIT LED EXIT SIGN Standard and New York Approved Models



IMPORTANT SAFEGUARDS

READ AND FOLLOW ALL SAFETY INSTRUCTIONS

- ⚠ WARNING:** FAILURE TO FOLLOW THESE INSTRUCTIONS AND WARNINGS MAY RESULT IN DEATH, SERIOUS INJURY OR SIGNIFICANT PROPERTY DAMAGE- For your protection, read and follow these warnings and instructions carefully before installing or maintaining this equipment. These instructions do not attempt to cover all installation and maintenance situations.
 - ⚠ WARNING:** RISK OF ELECTRIC SHOCK- NEVER CONNECT TO, DISCONNECT FROM, OR SERVICE WHILE EQUIPMENT IS ENERGIZED.
 - ⚠ WARNING:** RISK OF FIRE- Keep combustible material away from hot parts. Observe lamp manufacturer's warnings, recommendations and restrictions on lamp operation and maintenance. Make sure lamps are correctly installed.
 - ⚠ WARNING:** DO NOT USE ABRASIVE MATERIALS OR OTHER SOLVENTS. USE OF THESE SUBSTANCES MAY DAMAGE FIXTURE, WHICH MAY RESULT IN PERSONAL INJURY.
 - ⚠ WARNING:** RISK OF PERSONAL INJURY- This product may have sharp edges. Wear gloves to prevent cuts or abrasions when removing from carton, handling, installing and maintaining this product.
- Before wiring to power supply, turn off electricity at fuse or circuit breaker.
 - Disconnect AC power and unplug battery before servicing.
 - Consult your local building code for approved wiring and installation.
 - UL Damp location listed standard. (0°C- 50°C)
 - Do not let power supply cord touch hot surfaces.
 - Do not mount near gas or electric heater.
 - Do not install a damaged fixture.
 - This product must be installed in accordance with the applicable installation codes and ordinances.
 - All service shall be performed by qualified service personnel. This product must be installed and maintained in accordance with the applicable installation codes by a person familiar with the construction operation of the product and the hazards involved.
 - Equipment should be mounted in locations and at heights where it will not readily be subjected to tampering by unauthorized personnel.
 - The use of accessory equipment is not recommended by the manufacturer and may cause an unsafe condition.
 - Do not use this equipment for other than intended use.

**SAVE THESE INSTRUCTIONS!
AND DELIVER TO OWNER AFTER INSTALLATION**

INSTALLATION INSTRUCTIONS

INSTALLATION

CAUTION: TURN OFF AC POWER TO CIRCUIT BEFORE BEGINNING INSTALLATION.

NEW INSTALLATION (top mount) [For optional restricted ceiling access, see page 5]

1. See Figure 1 before beginning installation.
2. Position metal housing and bar hangers between ceiling or wall joists. Make sure bar hangers are in the correct position to be mounted. Position metal housing temporarily by hammering nail-in tabs on bar hangers, then secure permanently with nails or screw. Bar hangers should be level with bottom of joists (Figure 2).
3. Adjust height of metal housing so that the bottom of the housing is just above the ceiling or wall (Figure 3).
4. Reference correct wiring diagram and make proper electrical connections at the J-box in the metal housing (Figures 4 & 5).

CAUTION: The unused lead must be insulated with the remaining provided wire nut or other approved method.

5. Determine directional Chevron requirements. Follow instructions on provided templates to apply the required Chevron(s). See also Figure 6.
6. Attach safety chain to holes in trim plate assembly. Snap together the quick-connector harness to connect the LED board to the transformer.
7. Connect the battery (EL models) after continuous AC power can be provided to the unit.
8. Secure the trim plate assembly using the provided screws.

INSPECTION AND MAINTENANCE

NOTE: On emergency (EL) models, the battery may be supplied with less than a full charge. After continuous AC power is provided, allow 24 hours for full charge and before initial testing.

LAMP OR BATTERY REPLACEMENT: Use only the replacement part specified on the product (UL) label. Use of any other light source or battery may result in transformer damage or unsafe conditions.

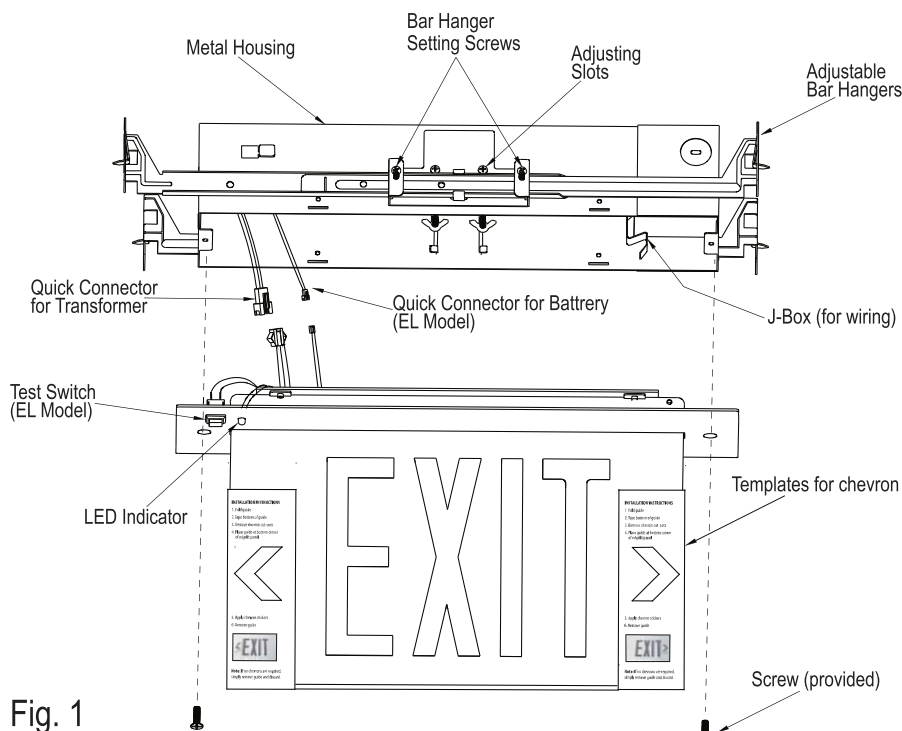

INSTALLATION INSTRUCTIONS

FOR RECESSED EDGE-LIT LED EXIT SIGN

READ AND FOLLOW ALL SAFETY INSTRUCTIONS

IMPORTANT SAFEGUARDS: When using electrical equipment, always adhere to basic safety precautions including the following:

WIRING DIAGRAMS

Note: Unused input lead must be properly insulated with wire nut or other approved method.

120/277 VOLT (BATTERY BACKUP)

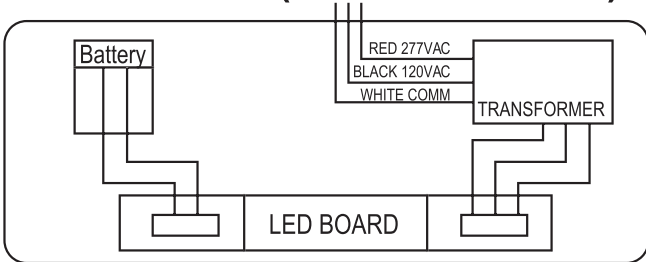

120/277 VOLT (AC ONLY)

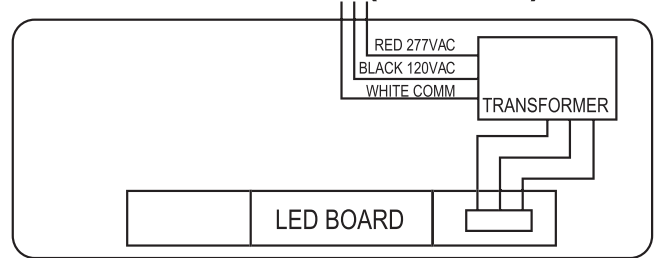

120/277 VOLT (SELF DIAGNOSTIC)

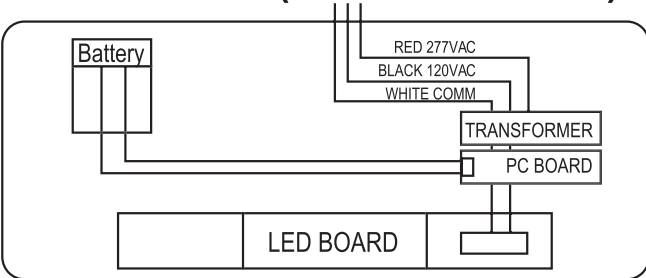

120/277 VOLT (DUAL CIRCUIT)*

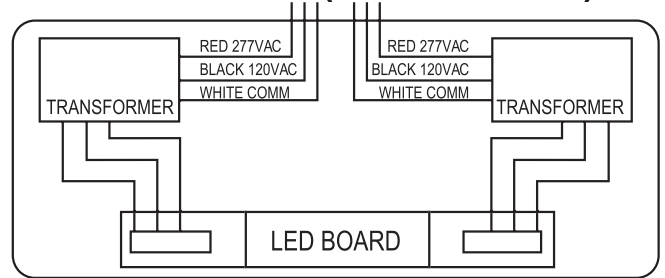

208/220/240 VOLT (BATTERY BACKUP)

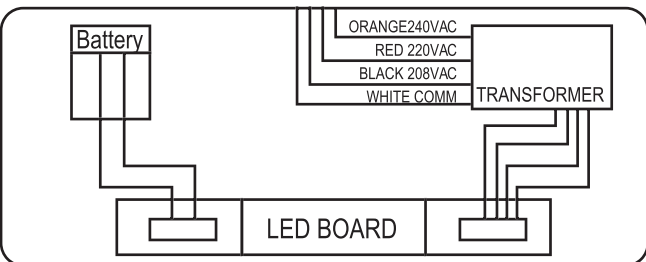

208/220/240 VOLT (AC ONLY)

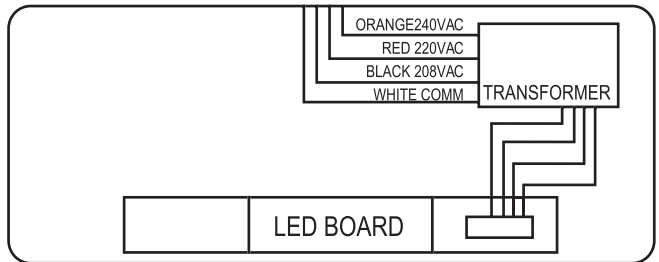

208/220/240 VOLT (DUAL CIRCUIT)*

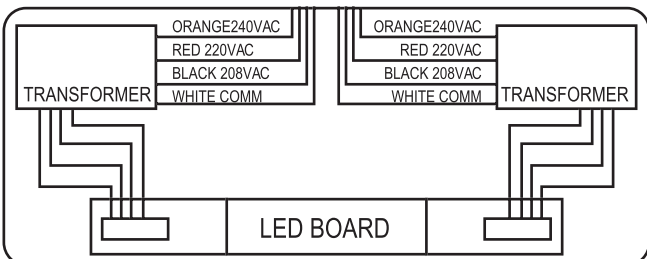

* Not available in New York
Approved models.

INSTALLATION INSTRUCTIONS

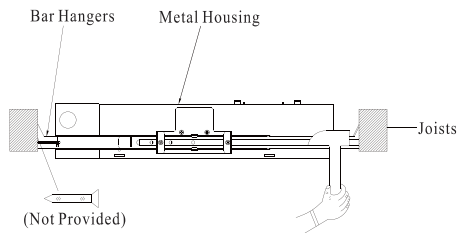

Fig. 2

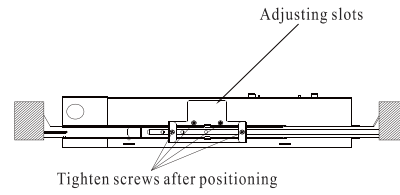

Fig. 3

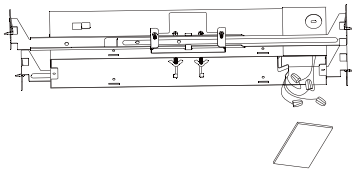

Fig. 4

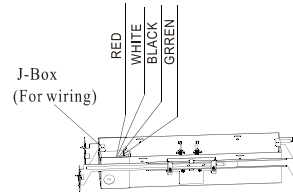

Fig. 5



Fig. 6

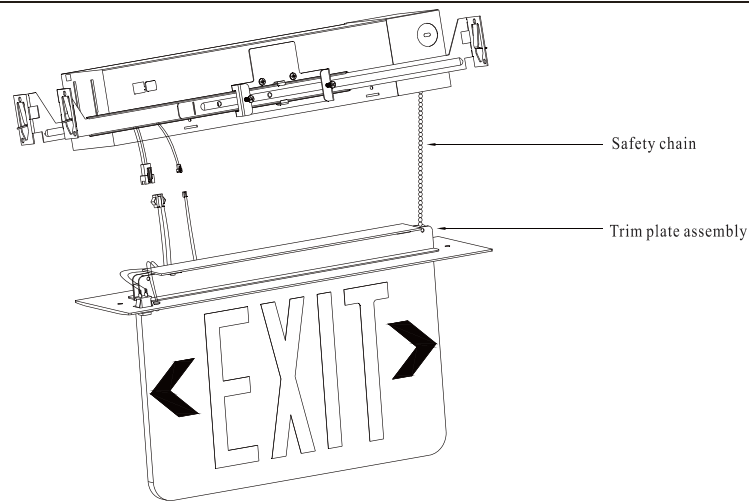

Fig. 7

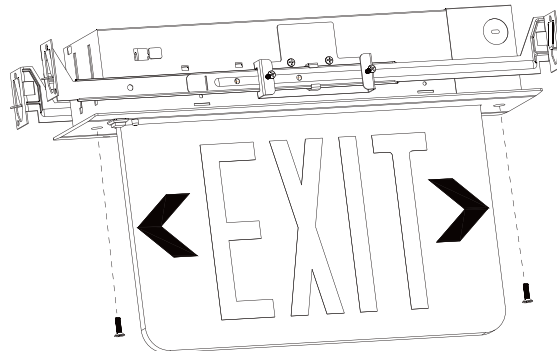

Fig. 8

INSTALLATION INSTRUCTIONS

OPTIONAL REMODEL BRACKET-MOUNT INSTALLATION INSTRUCTIONS

NOTE: The unit comes with hardware (placed in a separate pouch) for drywall remodel installation. The pouch should contain a set of (4) metal brackets, (4) small screws, (4) nuts, (4) long screws, and (4) screw holders.

1. Remove all mounting hanger bars.
2. Slide the screw holders into the holes on the unit's housing as shown in Figure A.
3. Secure the screw holders with the small screws provided (refer to Figures B and C).
4. Position the metal brackets beneath the screw holders and inset the long screws (refer to Figure D). Tighten the screw until the head reaches the screw holder (refer to Figure E).

CAUTION: DO NOT TIGHTEN THE SCREWS TO THE POINT WHERE THE BRACKETS START TO EXPAND OUTWARD.

5. Cut a hole in the ceiling or wall using the provided template. Turn housing on the side and slide through the hole in the ceiling or wall.
6. Once the housing is inside the ceiling or wall, return back to original position and start tightening the long screws. At this point the brackets start to bow out. (Figure F).
7. Follow steps 4-8 from page 2 to finish.

RECESSED BOX SIDE HANGER BAR-MOUNTING INSTRUCTION

1. Knock-out the slot at the end of recessed box. (refer to Figure H).
2. Un-tight the Wing Nut and remove both of the Hanger Bars and washers. (refer to Figure I).
3. Install the Hang Bar to the side of the recessed box and tight up the Wing Nut with the washer. (refer to Figure J).
4. Follow steps 1-8 from the "New Installation" Instructions (page 2).

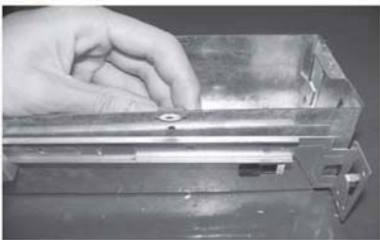

Figure A



Figure B

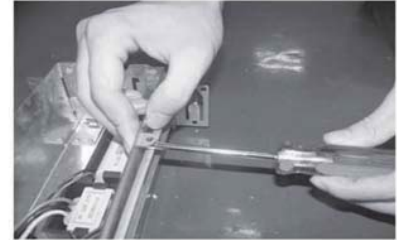

Figure C



Figure D



Figure E



Figure F



Figure G

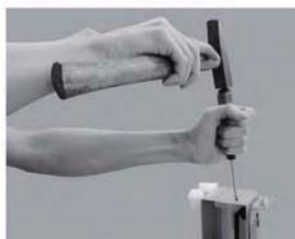

Figure H



Figure I

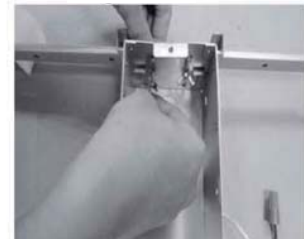

Figure J