

LRD SERIES RESIDENTIAL LIGHTING

LRD-TL-10W-27K-4R
LRD-TL-10W-30K-4R
LRD-TL-10W-35K-4R
LRD-TL-10W-40K-4R
LRD-TL-10W-50K-4R

Customer Name: _____
Project Name: _____
Note: _____ | Type: _____

4" LED ARCHITECTURAL TRIMLESS ROUND RECESSED LIGHTS

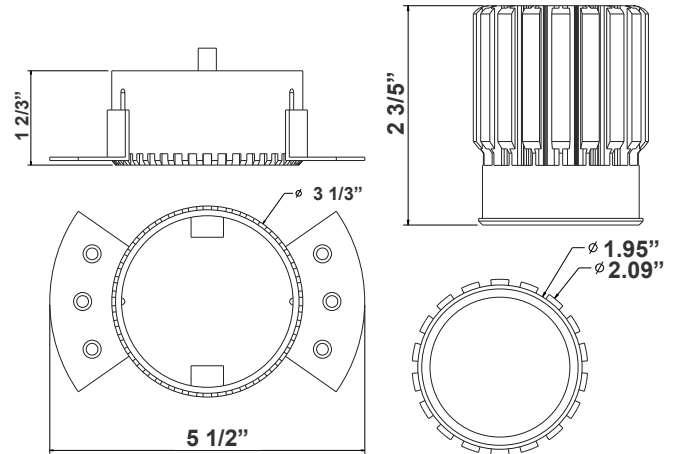

4 1/4"(H) X 5 1/2"(W)
Driver Box Dimensions:
5-1/4" x 1-5/8" x 1-1/8"

Ideal for New as well as old residential and commercial constructions.

Features

- 4" (3-1/4" Actual) LED Timeless Round Recessed Trim
- Die-Cast Aluminum With White Powder Coat Finish
- 5-Year Warranty
- Junction Box Included With Fixture

Technical Specifications

Electrical:

- Voltage: 120VAC
- Wattage: 10W
- Power factor: >0.90
- Efficacy: Up to 70 LM/W

Mechanical:

- Up to 9 AWG18 Wires
- Flanges can be adjusted for plaster up to 5/8" Thick
- Die-Cast Aluminum With White Powder Coat Finish
- Clear Glass Lens
- Junction Box Included With Fixture
- Type IC Rated: Approved For Direct Contact With Insulation
- Operating Temperature: 104°F
- Air-tight and Type IC Rated: No Housing Required
- Damp Location Approved
- 5-Year Warranty

Lighting:

- Dimming: Dimmable Down to 10% Using Standard TRIAC LED Dimmer
- Total Lumens: 700LM
- Color Temperature: 2700K/3000K/3500K/4000K/5000K
- Color Rendering index: >90
- Beam Angle: 30°
- Lifespan: 50,000 Hrs.

Applications:

- Ideal for New as well as old residential and commercial constructions.

Other Models:

- 10W | 700LM | LRD-TL-10W-27K-4S-MG/WH/BK/CHZ
- 10W | 700LM | LRD-TL-10W-27K-4S-MG/WH/BK/CHZ
- 10W | 700LM | LRD-TL-10W-27K-4S-MG/WH/BK/CHZ
- 10W | 700LM | LRD-TL-10W-27K-4S-MG/WH/BK/CHZ
- 10W | 700LM | LRD-TL-10W-27K-4S-MG/WH/BK/CHZ



Photometrics: LRD-TL-10W-27K-4R

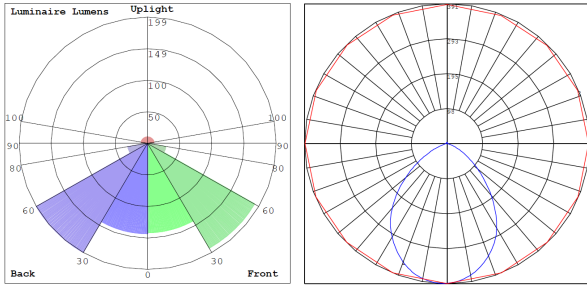

BUG Rating: B1-U2-G0

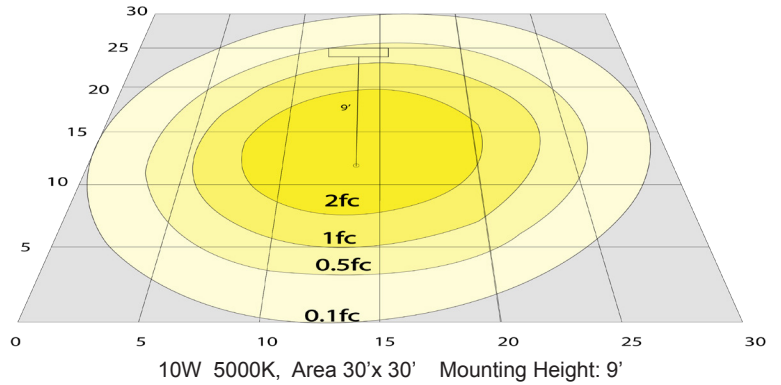

Other Views:



- LRD-TLTR4-MG
- LRD-TLTR4-MG
- LRD-TLTR4-MG
- LRD-TLTR4-MG
- LRD-TLTR4-MG

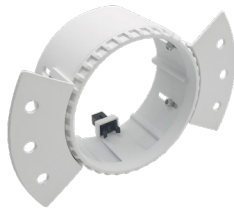

- LRD-TLHR4-WH
- LRD-TLHR4-WH
- LRD-TLHR4-WH
- LRD-TLHR4-WH
- LRD-TLHR4-WH



- LRD-EGN-10W-27K-D
- LRD-EGN-10W-30K-D
- LRD-EGN-10W-35K-D
- LRD-EGN-10W-40K-D
- LRD-EGN-10W-50K-D



- LRD-TL-10W-27K-4R-MG
- LRD-TL-10W-30K-4R-MG
- LRD-TL-10W-35K-4R-MG
- LRD-TL-10W-40K-4R-MG
- LRD-TL-10W-50K-4R-MG



- LRD-TLTR4-WH
- LRD-TLTR4-WH
- LRD-TLTR4-WH
- LRD-TLTR4-WH
- LRD-TLTR4-WH

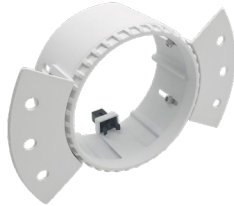

- LRD-TLHR4-WH
- LRD-TLHR4-WH
- LRD-TLHR4-WH
- LRD-TLHR4-WH
- LRD-TLHR4-WH



- LRD-EGN-10W-27K-D
- LRD-EGN-10W-30K-D
- LRD-EGN-10W-35K-D
- LRD-EGN-10W-40K-D
- LRD-EGN-10W-50K-D



- LRD-TL-10W-27K-4R-WH
- LRD-TL-10W-30K-4R-WH
- LRD-TL-10W-35K-4R-WH
- LRD-TL-10W-40K-4R-WH
- LRD-TL-10W-50K-4R-WH



- LRD-TLTR4-BK
- LRD-TLTR4-BK
- LRD-TLTR4-BK
- LRD-TLTR4-BK
- LRD-TLTR4-BK

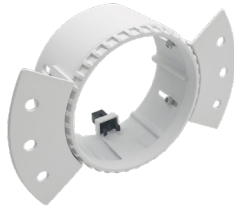

- LRD-TLHR4-WH
- LRD-TLHR4-WH
- LRD-TLHR4-WH
- LRD-TLHR4-WH
- LRD-TLHR4-WH



- LRD-EGN-10W-27K-D
- LRD-EGN-10W-30K-D
- LRD-EGN-10W-35K-D
- LRD-EGN-10W-40K-D
- LRD-EGN-10W-50K-D



- LRD-TL-10W-27K-4R-BK
- LRD-TL-10W-30K-4R-BK
- LRD-TL-10W-35K-4R-BK
- LRD-TL-10W-40K-4R-BK
- LRD-TL-10W-50K-4R-BK





LRD-TLTR4-C
LRD-TLTR4-C
LRD-TLTR4-C
LRD-TLTR4-C
LRD-TLTR4-C

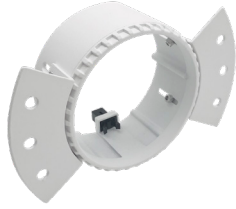

LRD-TLHR4-WH
LRD-TLHR4-WH
LRD-TLHR4-WH
LRD-TLHR4-WH
LRD-TLHR4-WH



LRD-EGN-10W-27K-D
LRD-EGN-10W-30K-D
LRD-EGN-10W-35K-D
LRD-EGN-10W-40K-D
LRD-EGN-10W-50K-D



LRD-TL-10W-27K-4R-C
LRD-TL-10W-30K-4R-C
LRD-TL-10W-35K-4R-C
LRD-TL-10W-40K-4R-C
LRD-TL-10W-50K-4R-C



LRD-TLTR4-HZ
LRD-TLTR4-HZ
LRD-TLTR4-HZ
LRD-TLTR4-HZ
LRD-TLTR4-HZ

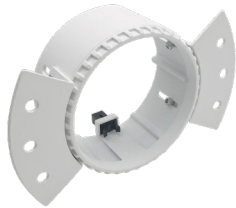

LRD-TLHR4-WH
LRD-TLHR4-WH
LRD-TLHR4-WH
LRD-TLHR4-WH
LRD-TLHR4-WH



LRD-EGN-10W-27K-D
LRD-EGN-10W-30K-D
LRD-EGN-10W-35K-D
LRD-EGN-10W-40K-D
LRD-EGN-10W-50K-D



LRD-TL-10W-27K-4R-HZ
LRD-TL-10W-30K-4R-HZ
LRD-TL-10W-35K-4R-HZ
LRD-TL-10W-40K-4R-HZ
LRD-TL-10W-50K-4R-HZ

Performance Table: LRD-10W-4WTR

MODEL NO.	Wattage	Voltage	Lumens	Color Temp.	BUG Rating	LPW
LRD-TL-10W-27K-4R	10W	120V	700LM	2700K	B1-U2-G0	70
LRD-TL-10W-30K-4R				3000K		
LRD-TL-10W-35K-4R				3500K		
LRD-TL-10W-40K-4R				4000K		
LRD-TL-10W-50K-4R				5000K		

Accessory:



Blank = No Option For Accessories
LRD-FGL = LRD SERIES FROSTED GUASS LENS

Accessory:

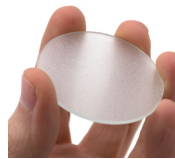

LRD-FGL

Sample Ordering

Model	Timeless	Wattage	Color Temp.	Size	Size					
LRD	-	TL	-	10W	-	[]	-	4R	-	[]
				27K = 2700K 30K = 3000K 35K = 3500K 40K = 4000K 50K = 5000K						MG = MATTE GOLD WH = WHITE BK = BLACK C = CLEAR HZ = MATTE SILVER

