

LRD SERIES RESIDENTIAL LIGHTING

LRD-10W-27K-3WTRPH
LRD-10W-30K-3WTRPH
LRD-10W-35K-3WTRPH
LRD-10W-40K-3WTRPH
LRD-10W-50K-3WTRPH

3" LED ARCHITECTURAL WINGED PIN HOLE RECESSED LIGHTS

Customer Name: _____

Project Name: _____

Note: _____

Type: _____

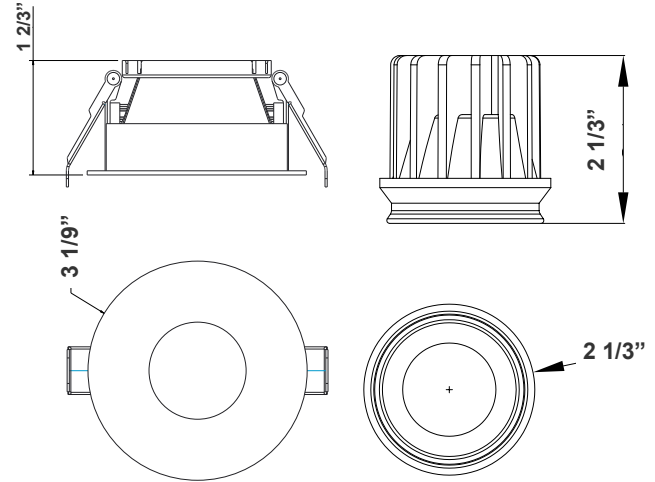
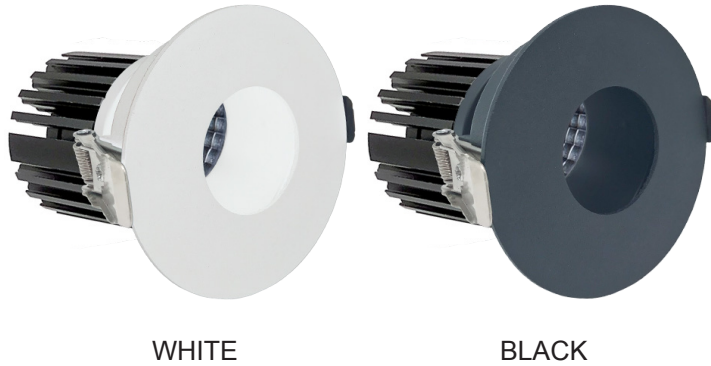

3 3/4"(H) X 3 1/9"(D)
Driver Box Dimensions:
5-1/4" x 1-5/8" x 1-1/8"

Ideal for New as well as old residential and commercial constructions.

Features

- 3" (2-1/8" Actual) LED Pin Hole Recessed Trim
- Die-Cast Aluminum With White Powder Coat Finish
- 5-Year Warranty
- Junction Box Included With Fixture

Technical Specifications

Electrical:

- Voltage: 120VAC
- Wattage: 10W
- Power Factor: >0.90
- Efficacy: Up to 70 LM/W

Mechanical:

- Die-Cast Aluminum With White Powder Coat Finish
- Clear Glass Lens
- Junction Box Included With Fixture
- Type IC Rated: Approved For Direct Contact With Insulation
- Operating Temperature: 104°F
- Air-Tight And Type IC Rated: No Housing Required
- Damp Location Approved
- 5-Year Warranty

Lighting:

- Dimming: Dimmable down to 10% Using Standard TRIAC LED Dimmer
- Total lumens: 700LM
- Color Temperature: 2700K/3000K/3500K/4000K/5000K
- Color Rendering index: >90
- Beam Angle: 30°
- Lifespan: 50,000 Hrs.

Applications:

- Ideal for New as well as old residential and commercial constructions.

Other Models:

- 7W | 490LM | LRD-10W-27K-3WTRPH-WH/BK
- 7W | 490LM | LRD-10W-30K-3WTRPH-WH/BK
- 7W | 490LM | LRD-10W-35K-3WTRPH-WH/BK
- 7W | 490LM | LRD-10W-40K-3WTRPH-WH/BK
- 7W | 490LM | LRD-10W-50K-3WTRPH-WH/BK



Photometrics: LRD-10W-3WTRPH

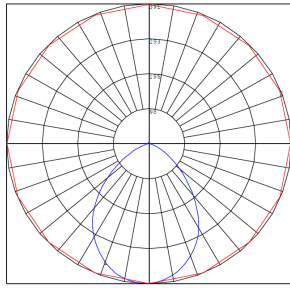
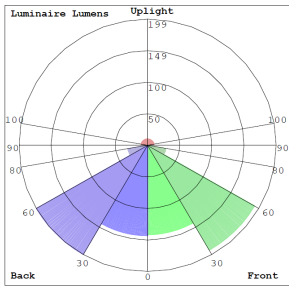

BUG Rating: B1-U2-G0

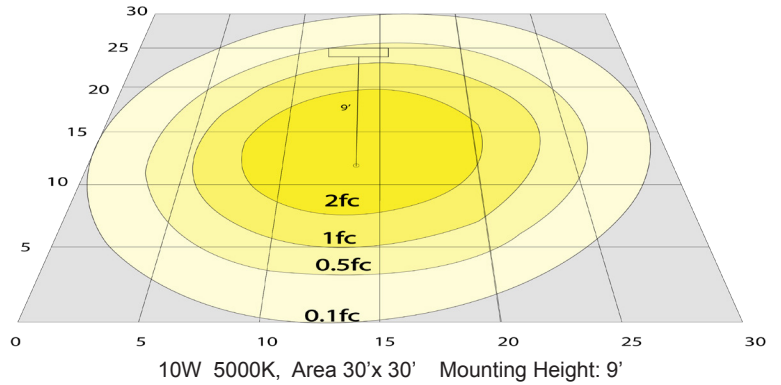

Other Views:



LRD-WTR3PH-WH
 LRD-WTR3PH-WH
 LRD-WTR3PH-WH
 LRD-WTR3PH-WH
 LRD-WTR3PH-WH

LRD-EGN-10W-27K-D
 LRD-EGN-10W-30K-D
 LRD-EGN-10W-35K-D
 LRD-EGN-10W-40K-D
 LRD-EGN-10W-50K-D

LRD-10W-27K-3WTRPH-WH
 LRD-10W-30K-3WTRPH-WH
 LRD-10W-35K-3WTRPH-WH
 LRD-10W-40K-3WTRPH-WH
 LRD-10W-50K-3WTRPH-WH

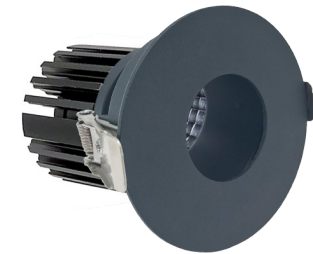

LRD-WTR3PH-BK
 LRD-WTR3PH-BK
 LRD-WTR3PH-BK
 LRD-WTR3PH-BK
 LRD-WTR3PH-BK

LRD-EGN-10W-27K-D
 LRD-EGN-10W-30K-D
 LRD-EGN-10W-35K-D
 LRD-EGN-10W-40K-D
 LRD-EGN-10W-50K-D

LRD-10W-27K-3WTRPH-BK
 LRD-10W-30K-3WTRPH-BK
 LRD-10W-35K-3WTRPH-BK
 LRD-10W-40K-3WTRPH-BK
 LRD-10W-50K-3WTRPH-BK

Performance Table: LRD-7W-3WTR

MODEL NO.	Wattage	Voltage	Lumens	Color Temp.	BUG Rating	LPW
LRD-10W-27K-3WTRPH	10W	120V	700LM	2700K	B1-U2-G0	70
LRD-10W-30K-3WTRPH				3000K		
LRD-10W-35K-3WTRPH				3500K		
LRD-10W-40K-3WTRPH				4000K		
LRD-10W-50K-3WTRPH				5000K		



Accessory:

Blank = No Option For Accessories
LRD-FGL = LRD SERES FROSTED GUASS LENS

Accessory:

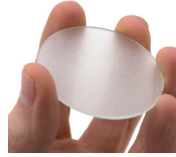

LRD-FGL

Sample Ordering

Model	Wattage	Color Temp.	Size	Size
LRD	10W	<input type="text"/>	3WTRPH	<input type="text"/>
		27K = 2700K 30K = 3000K 35K = 3500K 40K = 4000K 50K = 5000K		WH = WHITE BK = BLACK

