

LEDone[®]

LOC Tri Proof Vapor Tight Series Installation Guide

SAFETY INSTRUCTIONS: Read instructions carefully before attempting to install fixture.

- All wiring should be performed by a qualified electrician.
- Disconnect power before installing or servicing. This fixture must be wired in accordance with the National Electrical Code and applicable local codes and ordinances.

CAUTION: Risk of fire

- **WARNING:** Make certain power is OFF before installing or maintaining fixture. No user serviceable parts inside.
- **WARNING:** Do NOT handle energized fixture when hands are wet, when standing on wet or damp surfaces or in water.
- **WARNING:** Fixture to be independently supported to building structure.

CLEANING & MAINTENANCE:

CAUTION: Be sure the fixture temperature is cool enough to touch. Do NOT clean or maintain while the fixture is energized.

1. Clean lens with non-abrasive cleaning solution.
2. Do NOT open fixture to clean the LED. Do NOT touch the LED.

Note: These instructions do not cover all details or variation in equipment, nor do they provide for every possible situation during installation, operation or maintenance.

TROUBLESHOOTING:

1. Check that the line voltage at fixture is correct. Refer to wiring directions.
2. Check that the fixture is grounded properly.

0-10V DIMMABLE WIRING:

Universal voltage driver permits operation at 120V through 277V, 50/60Hz.

1. Connect the BLACK fixture lead to the (+) LINE supply lead.
2. Connect the WHITE fixture lead to the (-) COMMON supply lead
3. Connect the GROUND wire from fixture to the supply ground. Do NOT connect the GROUND of the dimming fixture to the output.
4. Connect the VIOLET fixture lead to the (V+) DIM lead.
5. Connect the GRAY fixture lead to the (V-) DIM lead.

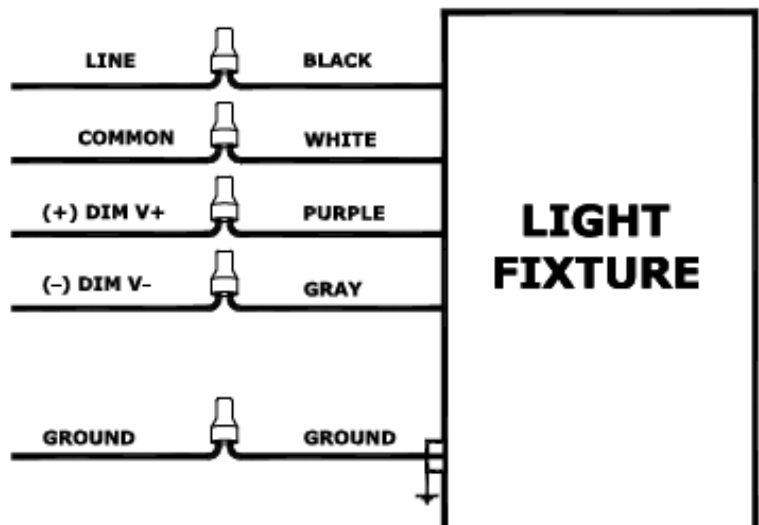

INSTALLATION OPTIONS: (surface mount or suspension mount)

CAUTION: Turn off electrical power at fuse or circuit breaker box before wiring fixture to the power supply.

SURFACE MOUNT

1. Open the clips on the end of the fixture. (Fig. 1)
2. Pull off the end cap. (Fig. 2)
3. Install the waterproof connector to the fixture. (Fig. 3)
4. Connect the wires. (Fig. 4)
5. Re-attach the end cap to the housing. (Fig. 5)
6. Fasten the clips on the fixture. (Fig. 6)
7. Install the mounting brackets to the installation surface. (Fig. 7)
8. Install the fixture to the mounting brackets. (Fig. 8)

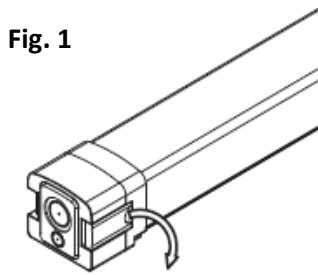

Fig. 1

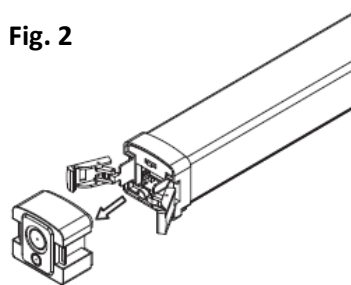

Fig. 2

Fig. 3

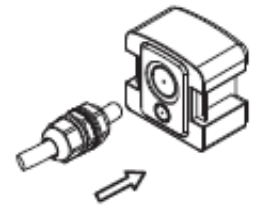

Fig. 4

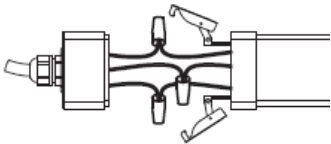

Fig. 5

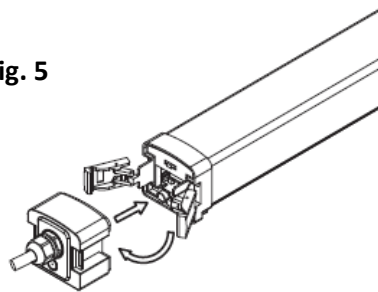

Fig. 6

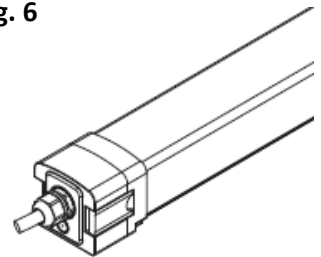

Fig. 7

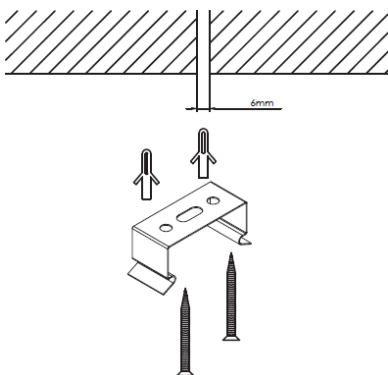
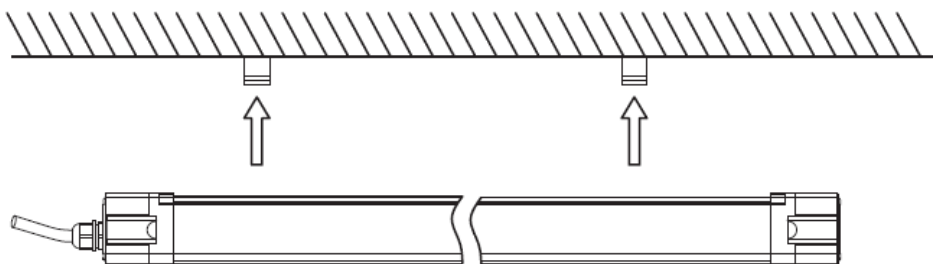

Fig. 8



INSTALLATION OPTIONS:

SUSPENSION MOUNT

1. Open the clips on the end of the fixture. (Fig. 1)
2. Pull off the end cap. (Fig. 2)
3. Install the waterproof connector to the fixture. (Fig. 3)
4. Connect the wires. (Fig. 4)
5. Re-attach the end cap to the housing. (Fig. 5)
6. Fasten the clips on the fixture. (Fig. 6)
7. Install the mounting brackets to the fixture. (Fig. 7)
8. Attach the suspension mount to the fixture and mount to the ceiling. (Fig. 8)

Fig. 1

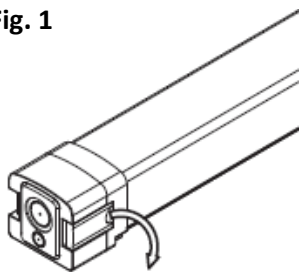

Fig. 2

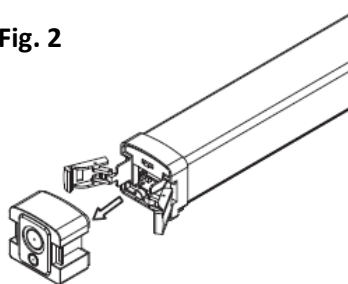

Fig. 3

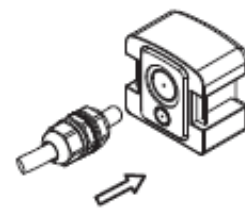

Fig. 4

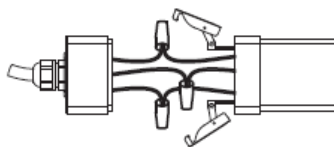

Fig. 5

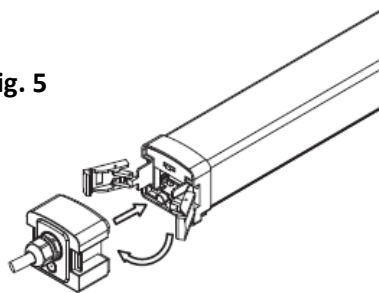

Fig. 6

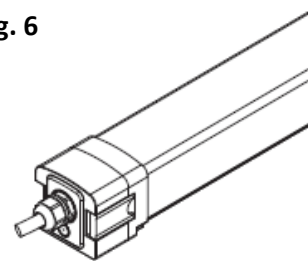

Fig. 7

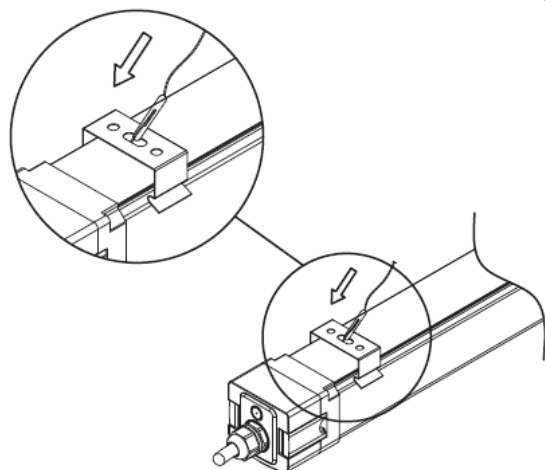
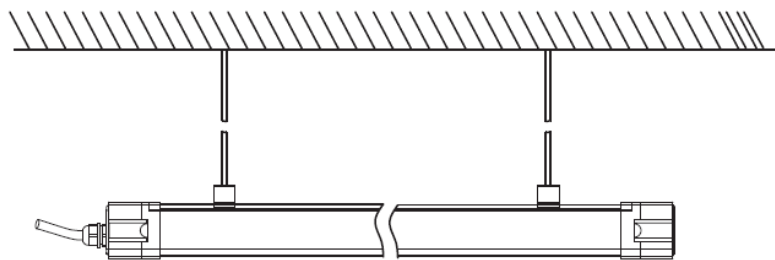

Fig. 8



SELECTABLE WATTAGE AND COLOR TEMPERATURE:

Selecting Wattage:

1. Take the end cap off from the other side of the fixture opposite of the wiring, locate the black toggle switch inside the fixture. There is a sticker labeled to select a wattage.
2. To change the wattage, please locate the silver box with wattage. The default wattage is the highest wattage option on the fixture (left position). You can adjust this by pushing the switch to the middle or the right (lowest wattage).

2 FOOT MODEL NUMBER:	Default Wattage (Left)	Middle Wattage (Middle)	Lowest Wattage (Right)
LOC-2FTTPVT-MW(20/25/30)MCCT(35/40/50)D	30W	25W	20W
4 FOOT MODEL NUMBER:	Default Wattage (Left)	Middle Wattage (Middle)	Lowest Wattage (Right)
LOC-4FTTPVT-MW(30/40/50)MCCT(35/40/50)D	50W	40W	30W
8 FOOT MODEL NUMBER:	Default Wattage (Left)	Middle Wattage (Middle)	Lowest Wattage (Right)
LOC-8FTTPVT-MW(60/80/100)MCCT(35/40/50)D	100W	80W	60W

LOC-2FTTPVT-MW(20/25/30)MCCT(35/40/50)D

LOC-4FTTPVT-MW(30/40/50)MCCT(35/40/50)D

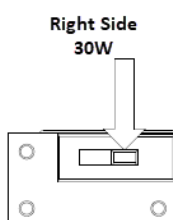
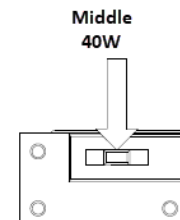
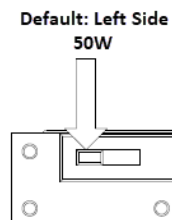
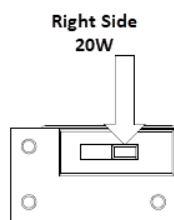
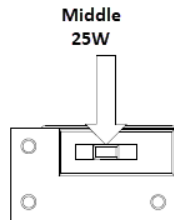
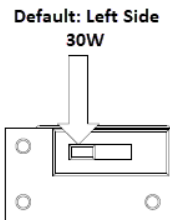

LOC-8FTTPVT-MW(60/80/100)MCCT(35/40/50)D

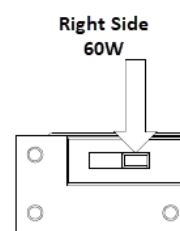
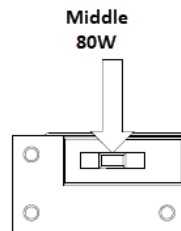
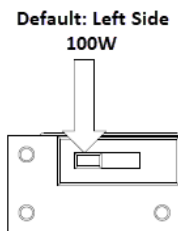

Selecting Color Temperature:

1. Take the end cap off from the other side of the fixture opposite of the wiring, locate the black toggle switch inside the fixture. There is a sticker labeled to select a color temperature.
2. To change the color temperature, please select slide the switch to your choosing. The default color temperature is the highest temperature option on the fixture left side 5,000K. You can adjust this by pushing the switch to the middle 4,000K or the right side 3,500K.

