

LFXPRO SERIES Outdoor Lighting

LFXPRO-LG-50-150W-MCTP-WH



Ideal for general site lighting, alleys, loading docks, doorway, pathway, and parking areas.

Customer Name: _____

Project Name: _____

Note: _____

Type: _____

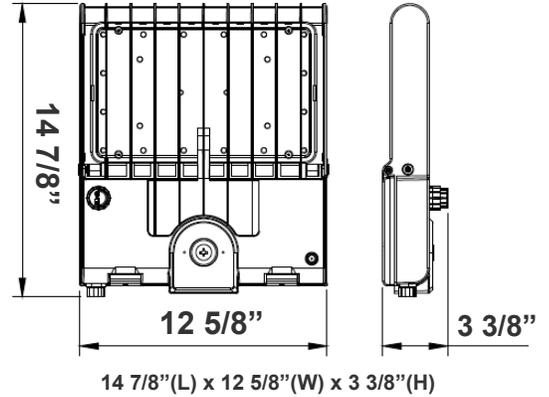

Features

- LED Flood Light
- With snap-on & bolt mounting options for one-person installations.
- Select a mounting option (Sold separately)

- 70,000 Hours Rated Life
- 7-Year Warranty
- Optic Lens Type: III
- Multi-CCT & Multi-Power - The Switches are on the Bottom of the Fixture

Technical Specifications

Electrical:

- Voltage: 100-277V AC 50/60Hz
- Wattage: 50W/ 80W/ 100W/ 150W
- Power Factor: >0.9
- Output Current: 0.25A
- Efficacy: 125 LPW
- THD: <20%

Mechanical:

- Housing: Die-cast Aluminum Housing with Powder Coat Finish (White)
- 10KV Lightning Surge Protection
- Operating Temperature: -40°F to 104°F
- IP Rating: IP65
- Suitable for Wet Locations
- Effective projected areas (EPA's) are:
Front = 0.38 square feet
Side = 0.30 square feet
Face = 1.05 square feet

Lighting:

- Dimmable: 0~10V
- Solid State Lighting technology for long life, no Maintenance needed and High-Efficiency
- Lens Type: Optical TYPE III Lens, High Light Transmittance PC, Anti-UV and Flame Resistant
- Cord Type: 3.2' SJTW 18/3 AWG cable
- Total lumens: 19200LM Max.
- Color temperature: 3000K/ 4000K/ 5000K/ 5700K
- Color rendering index: CRI ≥ 70
- Beam Angle: 90°x120°

Applications:

- Ideal for general site lighting, alleys, loading docks, doorway, pathway and parking areas.
- Replace existing HID flood lights/ wall packs

Other Models:

- 300W | 38000LM | LFXPRO-XL-150-300W-MCTP-WH



Photometrics: LFXPRO-LG-50-150W-MCTP-WH

TYPE III

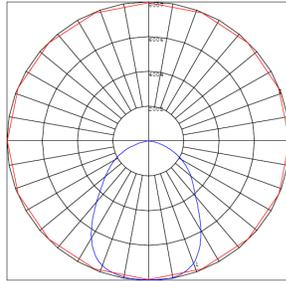
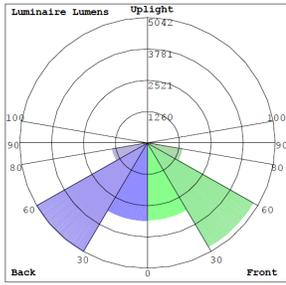

BUG Rating: B4-U0-G1

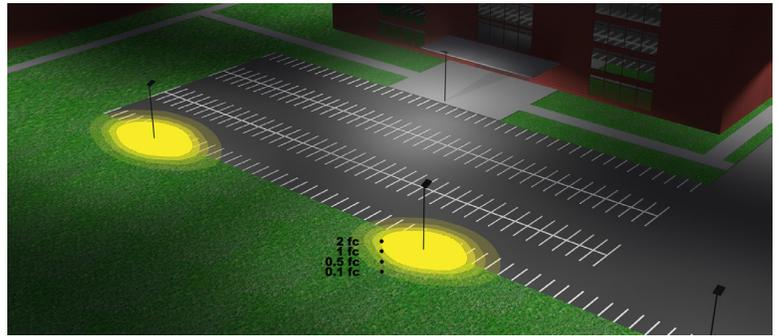

Area 65'x 75' Mounting Height: 20'

Other Views:



Side View



Front View



Back View

Performance Table: LFXPRO-LG-50-150W-MCTP-WH

MODEL NO.	Wattage	Voltage	Lumens	Color Temp.	BUG Rating	LPW	
LFXPRO-LG-50-150W-MCTP-WH	50W	120~277V	6800LM	3000K 4000K 5000K 5700K	B4-U0-G1	125	
			6950LM				
			7510LM				
	80W		7510LM				
			11000LM				
			11200LM				
	100W		11500LM				
			11500LM				
			13200LM				
			150W				13500LM
							14000LM
							14000LM
							18700LM
							18900LM
							19200LM
	19200LM						

Example:

1.LFXPRO-LG-50-150W-MCTP-WH

(For LFXPRO 150W MCTP fixture 120-277V)

2.LFXPRO-LG-50-150W-MCTP-WH
WEC-8RC

(For LFXPRO 150W MCTP fixture 120-277V)
(Remote Control)



Sample Ordering

Model Size Min. Wattage Max. Wattage Color Temp. Housing

LFXPRO - LG - 50 - 150W - MCTP - WH

Accessories Options

Blank = No Option For Accessories
WEC-8RC = Optional Motion Sensor Remote Control

Factory-Installed Options

Blank = No Option For Accessories
OPT-EM-OD2EXT = Emergency Battery Backup
OPT-3MPC = Microwave Photocell with a 1/2" threaded
OPT-SEN-3MR-3 = Programmable Microwave Bi-Level Sensor

ACCESSORIES:



WEC-8RC

Factory-Installed Opotions:



OPT-SEN-3MR-3



OPT-3MPC



OPT-EM-OD2EXT

Mounting Options:



LFX-ASA-WH
Adjustable Straight Arm
3 1/3" x 7 7/8"

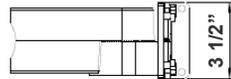
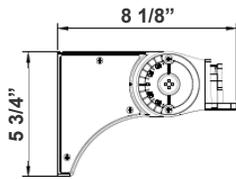

LFX-SF-WH + LFX-PASF-WH
Pole Adapter for Slip Fitter 6 1/8"
x 3 1/4" x 3"

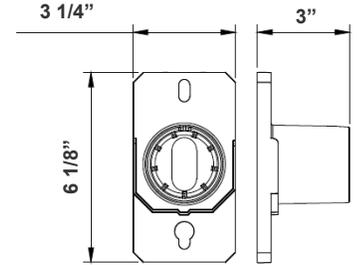

LFX-EXT-WH
Straight Arm
3 1/3" x 6 3/4" x 4 3/8"

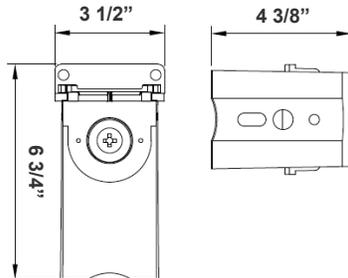

LFX-YK-WH
Yoke
5 3/4" x 6" x 2"

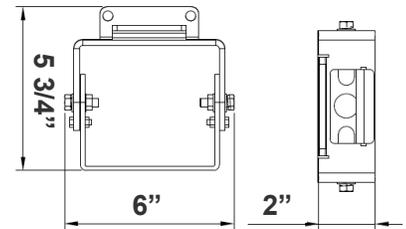

LFX-TR-A-WH
U Bracket
13 3/8" x 10 1/8"

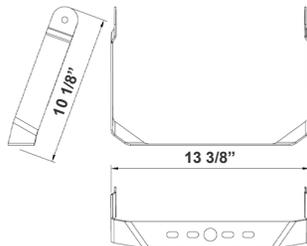

LFX-SF-WH
Slip Fitter
3 1/3" x 7 7/8"

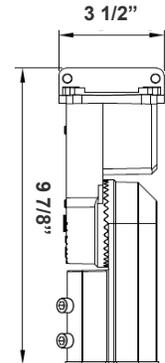

LFX-AWB-WH
Adjustable Wall Junction Box
7 1/8" x 6 5/8" x 5 3/4"

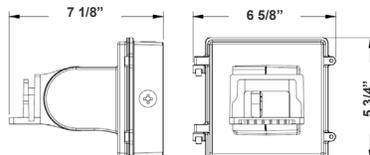

Color Options: LFXPRO-LG-50-150W-MCTP-WH
 Custom Color Available

Black Silver White **Dark Bronze** Green Red Yellow
Default color



Shroud & Wire Guard: LFXPRO-LG-50-150W-MCTP-WH



LF-SHROUD-A
 Shroud
 6 1/8" x 10 5/8" x 4 3/4"
 Can be painted

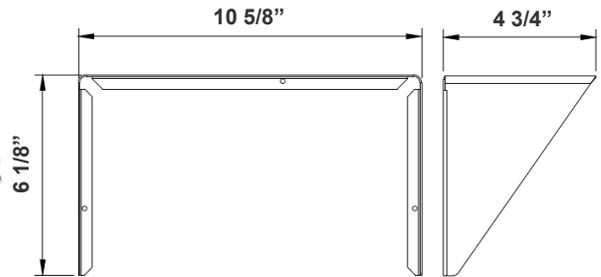

LF-SHROUD-D
 Full-Glare Shroud
 6 1/4" x 10 5/8" x 4 3/4"
 Can be painted

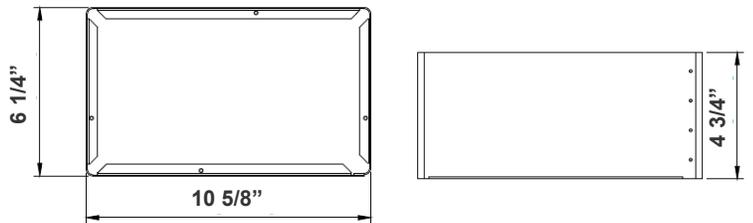

LFXPRO-WG-A
 Wire Guard
 Can be painted

