

# KT-CLED60PS-M1-8CSB-VDIM

## LED CANOPY LIGHT FIXTURE

### DESCRIPTION

General Purpose LED Canopy Light | Power Select 60/50/40W | Color Select 3000/4000/5000K | 120–277V Input | Bronze Housing

### APPLICATION

Ceiling mounted outdoor illumination needs, such as parking garages, covered walkways, entrance areas, etc.



### PRODUCT FEATURES

- Keystone Power Select technology (60/50/40W)
- Keystone Color Select technology (3000/4000/5000K)
- Familiar, low profile design ideal for a wide range of new and replacement installations
- Heavy duty die cast aluminum housing with a modern aesthetic and (3) 1/2" NPT threaded conduit hubs
- Suitable for standard junction box mounting or 3/4" NPT pendant mounting
- Built in dusk to dawn photocell behind translucent 3/4" threaded plug with anti-yellowing agent
- Impact resistant, polycarbonate diffuser with 160° parking garage distribution. Perfect for low mounting applications
- Suitable for California Title 24 (Part 6) code compliance requirements when used with suitable sensor / control device(s).
- Optional 110° canopy distribution diffuser available. Perfect for high mounting applications
- KTS-MW3-12V-PKO, quick install bi-level occupancy sensor accessory available
- KTSL-FC4-12V-PKO, Smart Loop Bluetooth wireless controller accessory available
- Powered by Keystone LED 0–10V dimming driver
- Ambient operating temperature: –40°C/–40°F to 50°C/122°F
- UL certified for wet locations, IP65 rated
- Power Factor: > 0.95
- THD: < 20%
- L70 @ >100,000 hrs @ 25°C/77°F ambient fixture temperature
- Meets FCC Part 15, Part B, Class A standards for conducted and radiated emissions

### PERFORMANCE SPECIFICATIONS

Catalog Number	Selectable Wattage	Selectable CCT	Lumens	Efficacy	Input Voltage	Dimming	CRI	Distribution Pattern	Photocell Included	Nominal Size	Housing Color	Legacy Equivalent
KT-CLED60PS-M1-8CSB-VDIM	60W	3000K	7500	125 lm/W	120–277V	0–10V	>80	160°	Yes	10" square	Bronze	250W MH
		4000K	8400	140 lm/W								
		5000K	7800	130 lm/W								
	50W	3000K	6250	125 lm/W								
		4000K	7000	140 lm/W								
		5000K	6500	130 lm/W								
	40W	3000K	5000	125 lm/W								
		4000K	5600	140 lm/W								
		5000K	5200	130 lm/W								

Note: Preset to highest lumen output (60W/5000K)

Note: Color uniformity: CCT (Correlated Color Temperature) range as per guidelines outlined in ANSI C78.377-2017

# KT-CLED60PS-M1-8CSB-VDIM

## LED CANOPY LIGHT FIXTURE

**PHOTOMETRIC SPECIFICATIONS**

**ISOCANDELA PLOT**

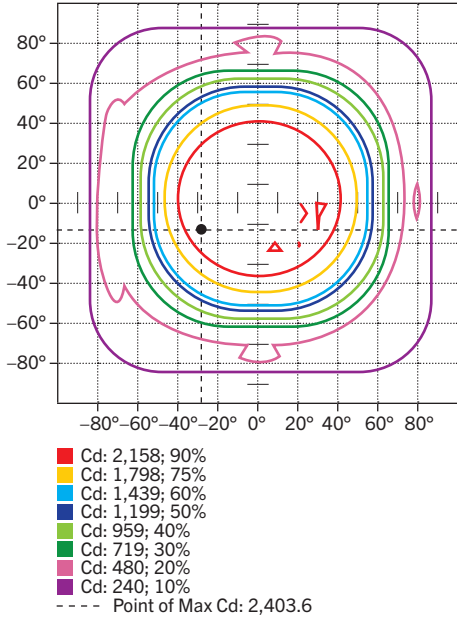

**POLAR CANDELA DISTRIBUTION**

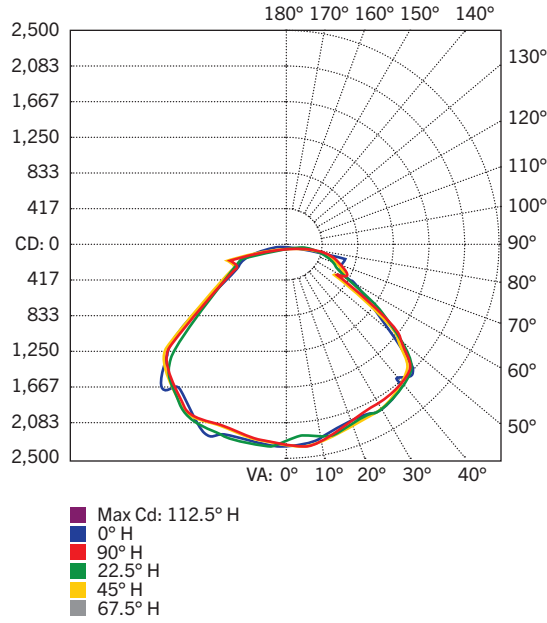

**ZONAL LUMEN SUMMARY**

Zone	Lumens	% Luminaire
0-30	1,903.5	24.7%
0-40	3,296.9	42.8%
0-60	5,945.7	77.2%
60-90	1,530.4	19.9%
70-100	887.7	11.5%
90-120	180.4	2.3%
0-90	7,476.1	97.0%
90-180	229.2	3.0%
0-180	7,705.3	100%

**DIMENSIONS**

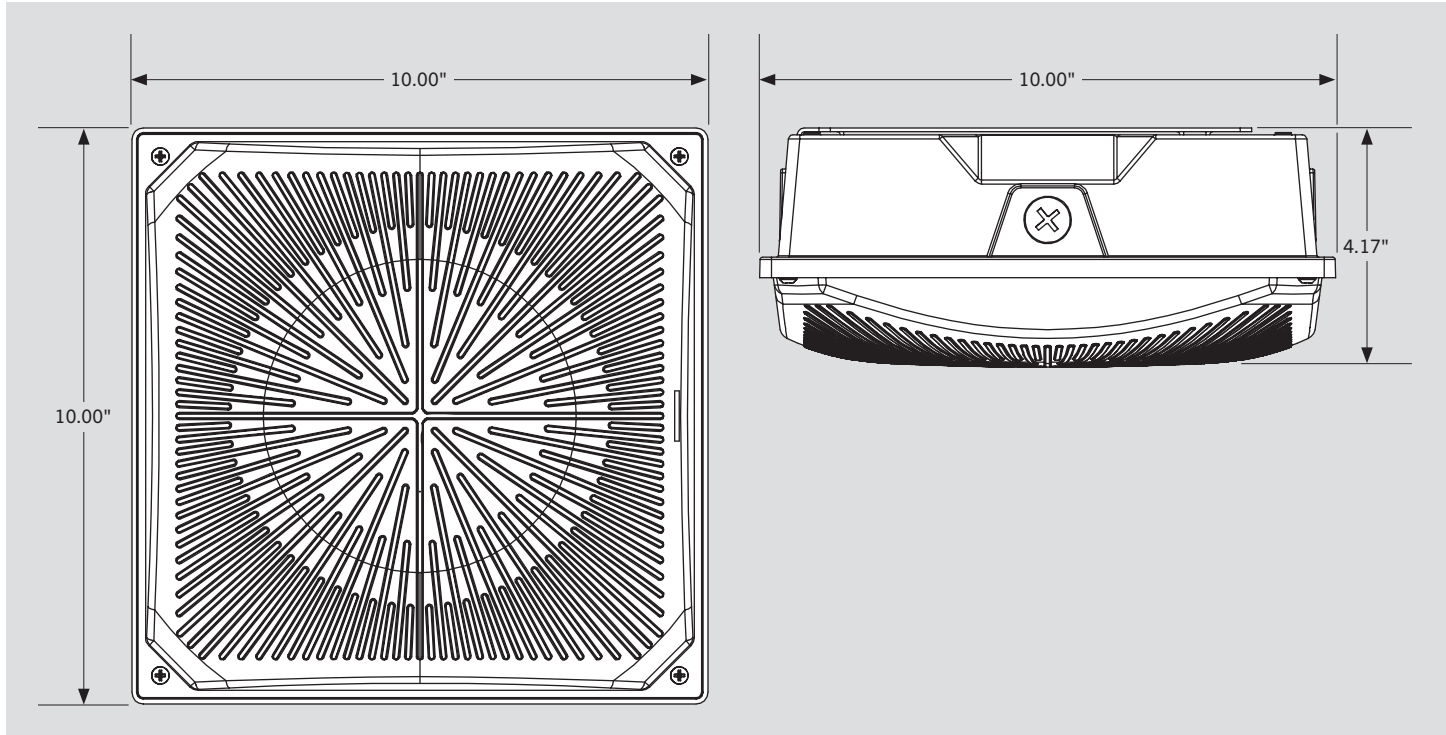

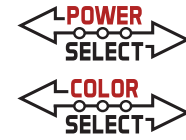

# KT-CLED60PS-M1-8CSB-VDIM

## LED CANOPY LIGHT FIXTURE

### POWER SELECT (WATTAGE) AND COLOR SELECT (CCT) ADJUSTMENT

This fixture is equipped with field-adjustable Keystone Power Select and Color Select technology.

1. Ensure power is off to the fixture.
2. Remove knockouts.
3. Adjust dip switches to desired settings.
4. Replace knockouts.
5. Restore power to fixture.

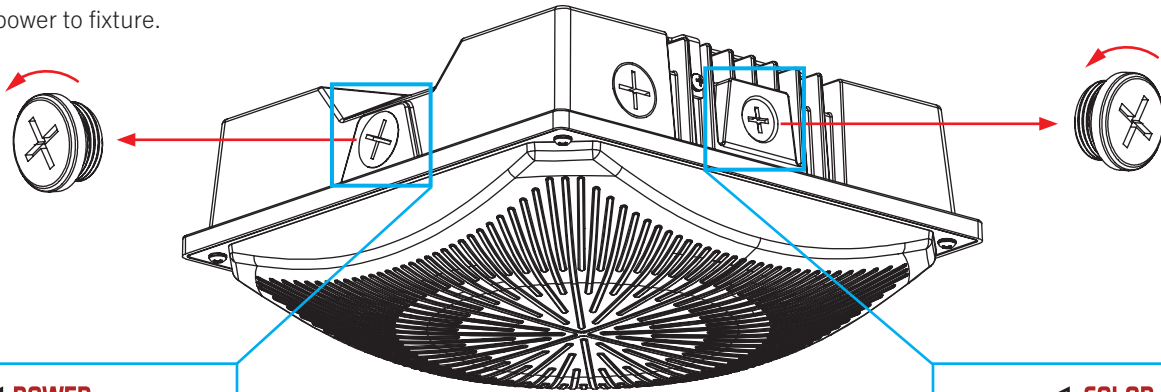



**POWER SELECT ADJUSTMENT SWITCH**  
Set dip switch to adjust wattage between 40W, 50W, and 60W. Fixture comes preset at 60W.

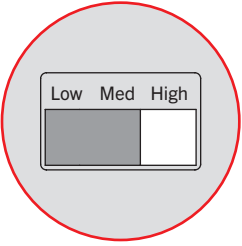



**COLOR SELECT ADJUSTMENT SWITCH**  
Set dip switch to adjust CCT between 3000K, 4000K, and 5000K. Fixture comes preset at 5000K.

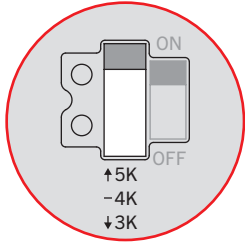

**PHOTOCELL ON/OFF SWITCH**  
Set dip switch to turn on or turn off built-in photocell.

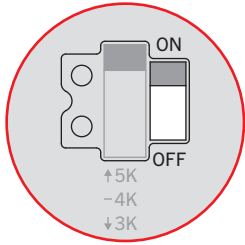

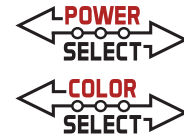

# KT-CLED60PS-M1-8CSB-VDIM

## LED CANOPY LIGHT FIXTURE

### WIRING DIAGRAMS

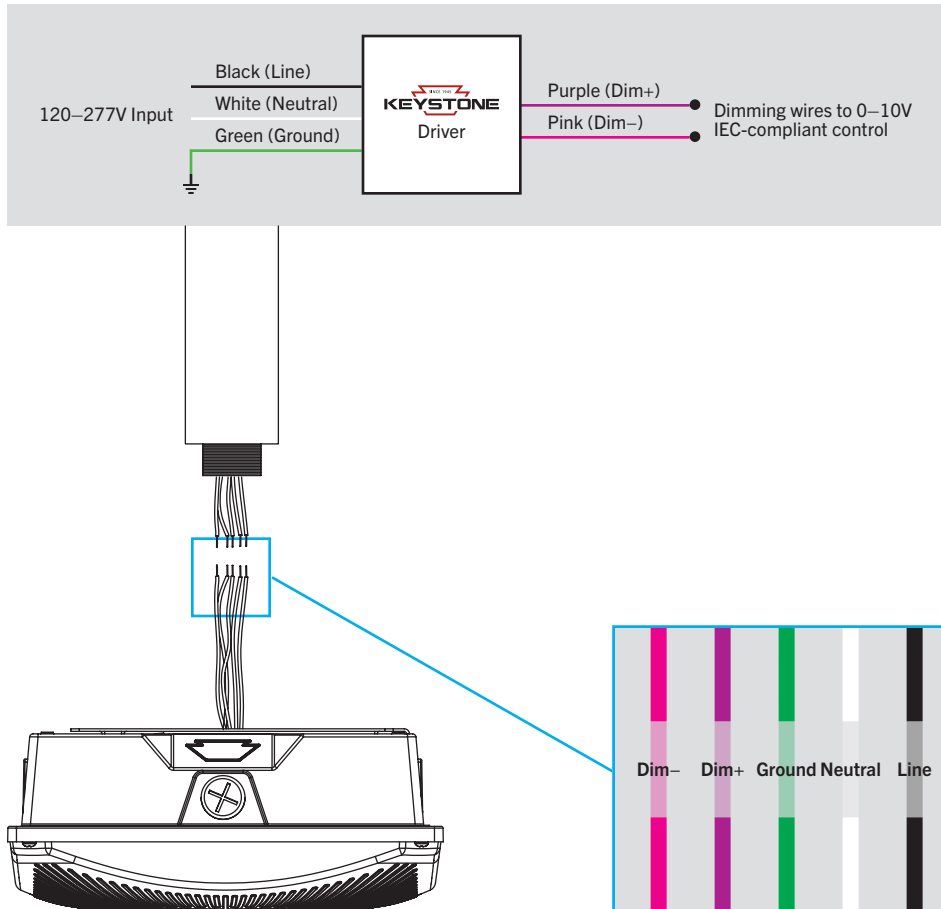

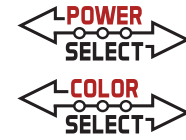

# KT-CLED60PS-M1-8CSB-VDIM

## LED CANOPY LIGHT FIXTURE

### ACCESSORIES

#### SENSORS / CONTROLLERS

Factory-Installable OR Field-Installable (field-installable purchased separately)

✓	SUFFIX*	CATALOG NUMBER	DESCRIPTION	UPC	EASY CODE
	/FC4	KTSL-FC4-12V-PKO	Bluetooth mesh wireless screw-in low voltage fixture controller for SmartLoop system; 12V; 0–10V dimming 	843654149066	RUN-10
	/MW3	KTS-MW3-12V-PKO	Screw-in microwave sensor for round high bays; Preset for 10 min hold time, ∞ standby time at 50% dim, daylight disabled	843654135212	TRM-32



#### LENSES

Factory-Installable OR Field-Installable (field-installable purchased separately)

✓	SUFFIX*	CATALOG NUMBER	DESCRIPTION	UPC	EASY CODE
	/L110	KT-CLED-LENS-M1-110-KIT	110° beam angle lens for 10" square canopy	843654152004	AHD-34



#### MOUNTS AND BRACKETS

Field-Installable / Field-Use ONLY (purchased separately)

CATALOG NUMBER	DESCRIPTION	UPC	EASY CODE
KT-CLED-BP-15	15" mounting back plate for canopy fixture; Bronze	843654152028	FHA-85



\* For factory installation of accessory, add suffix to fixture part number (see ordering examples and instructions on last page of spec sheet).

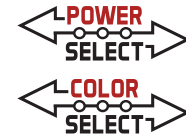

# KT-CLED60PS-M1-8CSB-VDIM

## LED CANOPY LIGHT FIXTURE

### FIXTURE ORDERING INFORMATION

ORDER CODE	PACK QTY.	UPC	Easy Code
KT-CLED60PS-M1-8CSB-VDIM	1	843654151953	TDT-55

### FIXTURE CATALOG NUMBER BREAKDOWN

# KT-CLED60PS-M1-8CSB-VDIM

- |          |                        |           |                              |           |  |
|----------|------------------------|-----------|------------------------------|-----------|--|
| <b>1</b> | Keystone Technologies  | <b>7</b>  | Series 1                     | <b>12</b> |  |
| <b>2</b> | Canopy Light Fixture   | <b>8</b>  | 80 CRI                       |           |  |
| <b>3</b> | LED Technology         | <b>9</b>  | Color Select Technology      |           |  |
| <b>4</b> | Max Wattage            | <b>10</b> | Color Select 3000/4000/5000K |           |  |
| <b>5</b> | Power Select 60/50/40W | <b>11</b> | 0-10V Dimming                |           |  |
| <b>6</b> | Medium Size            | <b>12</b> | Housing Color                |           |  |

**12 Housing Color**

(blank)	Bronze
W	White

### ORDERING EXAMPLES

FIXTURE WITH MULTIPLE FACTORY-INSTALLED ACCESSORIES\*

**KT-CLED60PS-M1-8CSB-VDIM/FC4/L110**

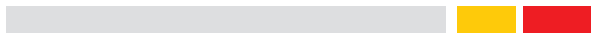

FIXTURE WITH SINGLE FACTORY-INSTALLED ACCESSORY

**KT-CLED60PS-M1-8CSB-VDIM/FC4**

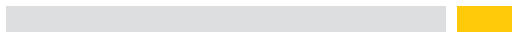

FIXTURE WITH NO FACTORY-INSTALLED ACCESSORIES

**KT-CLED60PS-M1-8CSB-VDIM**

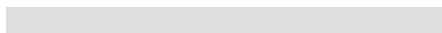

KEYSTONE FIXTURE	
CATALOG NUMBER	
KT-CLED60PS-M1-8CSB-VDIM	

SENSORS/CONTROLLERS	
✓ SUFFIX	CATALOG NUMBER
✓ /FC4	KTSL-FC4-12V-PKO

LENSES	
✓ SUFFIX	CATALOG NUMBER
✓ /L110	KT-CLED-LENS-M1-110-KIT

\* When ordering more than one factory-installed accessory, use multiple suffixes as shown in the ordering examples above.  
 Note: All accessories can also be ordered separately for field installation using just their regular Catalog Number, UPC, or Easy Code.