

Durable Lighting Made for Industrial Safety



Hazardous Location LED Luminaire B Series (for North America)

Explosion-proof Light B Series (for North America)



B2



B



B3



B4



Convex Glass
(Optional)



Globe Glass with Wire Guard
(Optional)



Product Description

The B Series LED luminaire is the ideal choice for marine and hazardous applications. They can be used in locations where moisture, dirt, dust, corrosion and vibration may be present, or areas where wind, water, snow or high ambient can be expected.

Features

- 0-10V dimming
- High luminous efficacy - Up to 140 lumens per watt
- Battery backup function available
- Compact and robust structure, excellent reliability
- Various installation ways for different applications
- Great impact resistance with IK08/IK10 certified

Compliance

UL 844 Hazardous Locations
Class I Division 2, Group A, B, C, D
Class II Division 1, Group E, F, G
Class II Division 2, Group F, G
Class III
Class I, Zone 2, Group IIC
Class II, Zone 21, Group IIIC
UL 1598 Wet Locations
UL 1598A Marine Outside Type
UL 924 Emergency Lighting
CSA C22.2#250.0:2021 Ed.5
CSA C22.2#137:2018 Ed.2
ETL (ATM for Report 105342415DAL-001)
ABS
NSF
DLC*
IP66/IP67
IK08 (glass cover)
IK10 (with wire guard)
1000 hours salt spray
5G vibration

* Not all product variations listed on this spec sheet are DLC qualified.
Visit www.designlights.org/search to confirm qualification.



Application

- Power Plants
- Heavy Industrials Storage Facility
- Paper mills
- Wastewater Treatment Plants
- Loading Docks Platforms
- Offshore Environments
- Chemical Processing Facility
- Petrochemical Processing Facility
- Metallurgical Industry
- Coal Mine
- Food and Alcohol industry



Warranty

5-Year Standard Warranty

LED lumen Maintenance: L70> 150,000 Operation Hours@55°C

Technical Parameter

• Electrical

Specification	EX-20W B2YZDA	EX-40W B2YZDA	EX-60W BYZDA	EX-80W BYZDA
Rated Power	20W	40W	60W	80W
Input Voltage	120-277/277-480VAC			
Input Frequency	50/60Hz			
Power Factor	> 0.95			
Emergency	No emergency function	No emergency function	Optional (Billda)	Optional (Billda)

• Optical

Specification	EX-20W B2YZDA	EX-40W B2YZDA	EX-60W BYZDA	EX-80W BYZDA
Lumen Output	3023lm	5,600lm	8,400lm	11,200lm
Lumens Per Watt	148lm/W	140lm/W	140lm/W	140lm/W
CCT	2700K-7000K			
CRI	> 70			
Beam Angle	40°/60°/90°/120°			
Dimming	0-10V dimming			

• Environmental

Specification	EX-20W B2YZDA	EX-40W B2YZDA	EX-60W BYZDA	EX-80W BYZDA
Ambient Operating Temperature	T3: -40°C to +50°C (-40°F to +122°F)			

• Mechanical

Specification	EX-20W B2YZDA	EX-40W B2YZDA	EX-60W BYZDA	EX-80W BYZDA
Housing Material	Copper-free aluminum			
Diffuser	Tempered glass & PC			
Hardware	Stainless steel			
Fixture Color	Gray RAL7040 (Standard)			
Protection	IP66/IP67/IK08 (glass cover)/IK10 (with wire guard)			
Mounting	Wall, Pole, Ceiling, Arm, Stanchion, Hook			
Cable Entries*	Side: 3/4 NPT, M20, M25, 1/2NPT Top: 3/4 NPT, M25			

*Cable Entries: For side and top, 3/4 NPT is standard. If others are required, customer needs to indicate when placing an order.

Technical Parameter

• Electrical

Specification	EX-100W B3YZDA	EX-120W B3YZDA	EX-150W B3YZDA	EX-200W B3YZDA
Rated Power	100W	120W	150W	200W
Input Voltage	120-277/277-480VAC			
Input Frequency	50/60Hz			
Power Factor	> 0.95			
Emergency	Optional			

• Optical

Specification	EX-100W B3YZDA	EX-120W B3YZDA	EX-150W B3YZDA	EX-200W B3YZDA
Lumen Output	16,183lm	16,800lm	23,286lm	28,000lm
Lumens Per Watt	160lm/W	140lm/W	155lm/W	140lm/W
CCT	2700K-7000K			
CRI	> 70			
Beam Angle	40°/60°/90°/120°			
Dimming	0-10V dimming			

• Environmental

Specification	EX-100W B3YZDA	EX-120W B3YZDA	EX-150W B3YZDA	EX-200W B3YZDA
Ambient Operating Temperature	T3: -40°C to +40°C (-40°F to +104°F)			

• Mechanical

Specification	EX-100W B3YZDA	EX-120W B3YZDA	EX-150W B3YZDA	EX-200W B3YZDA
Housing Material	Copper-free aluminum			
Diffuser	Tempered glass & PC			
Hardware	Stainless steel			
Fixture Color	Gray RAL7040 (Standard)			
Protection	IP66/IP67/IK08 (glass cover)/IK10 (with wire guard)			
Mounting	Wall, Pole, Ceiling, Arm, Stanchion, Hook			
Cable Entries*	Side: 3/4 NPT, M20, M25, 1/2NPT Top: 3/4 NPT, M25			

*Cable Entries: For side and top, 3/4 NPT is standard. If others are required, customer needs to indicate when placing an order.

Technical Parameter

• Electrical

Specification	EX-250W B4YZDA	EX-300W B4YZDA	EX-350W B4YZDA	EX-400W B4YZDA
Rated Power	250W	300W	350W	400W
Input Voltage	120-277/277-480VAC			
Input Frequency	50/60Hz			
Power Factor	> 0.95			
Emergency	Optional			

• Optical

Specification	EX-250W B4YZDA	EX-300W B4YZDA	EX-350W B4YZDA	EX-400W B4YZDA
Lumen Output	35,000lm	42,000lm	49,000lm	65,163lm
Lumens Per Watt	140lm/W	140lm/W	140lm/W	158lm/W
CCT	2700K-7000K			
CRI	> 70			
Beam Angle	40°/60°/90°/120°			
Dimming	0-10V dimming			

• Environmental

Specification	EX-250W B4YZDA	EX-300W B4YZDA	EX-350W B4YZDA	EX-400W B4YZDA
Ambient Operating Temperature	T3: -40°C to +55°C (-40°F to +131°F)	T3: -40°C to +55°C (-40°F to +131°F)	T3: -40°C to +40°C (-40°F to +104°F)	T3: -40°C to +40°C (-40°F to +104°F)

• Mechanical

Specification	EX-250W B4YZDA	EX-300W B4YZDA	EX-350W B4YZDA	EX-400W B4YZDA
Housing Material	Copper-free aluminum			
Diffuser	Tempered glass & PC			
Hardware	Stainless steel			
Fixture Color	Gray RAL7040 (Standard)			
Protection	IP66/IP67/IK08 (glass cover)/IK10 (with wire guard)			
Mounting	Wall, Pole, Ceiling, Arm, Stanchion, Hook			
Cable Entries*	Side: 3/4 NPT, M20, M25, 1/2NPT Top: 3/4 NPT, M25			

*Cable Entries: For side and top, 3/4 NPT is standard. If others are required, customer needs to indicate when placing an order.

Product Dimensions

B2

Without drop lens:

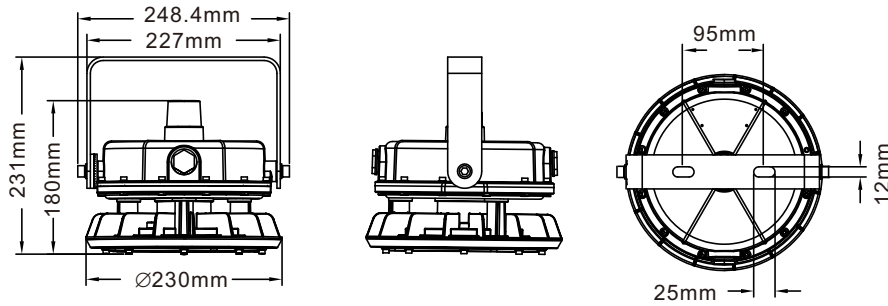

With drop lens:

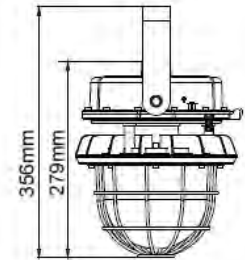

B

Without drop lens:

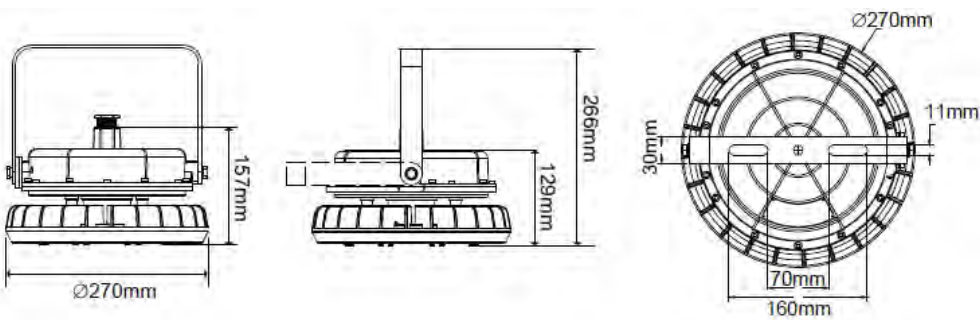

With drop lens:

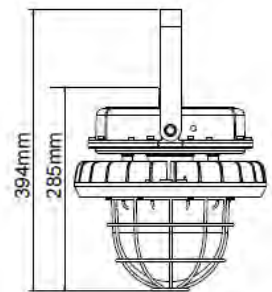

B3

Without drop lens:

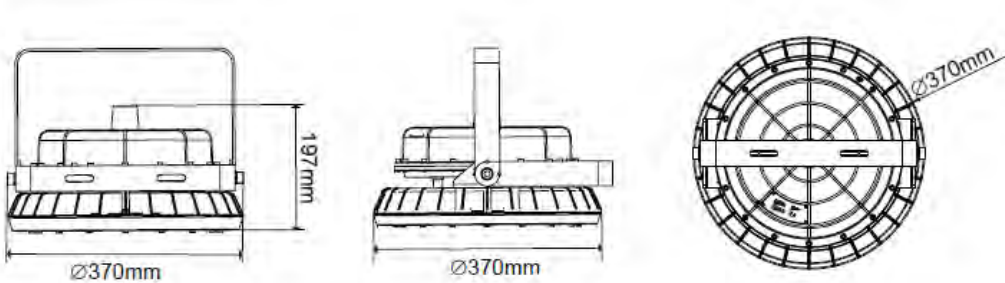

With drop lens:

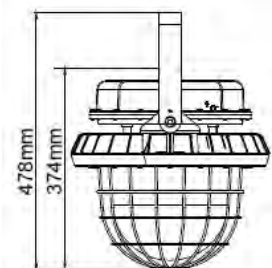

B4

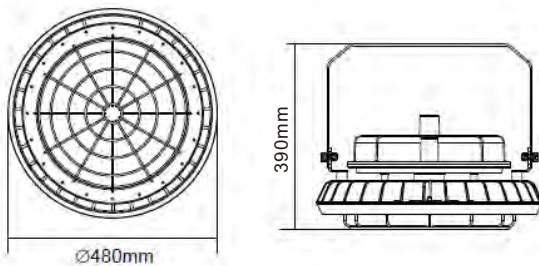

Cable Entries

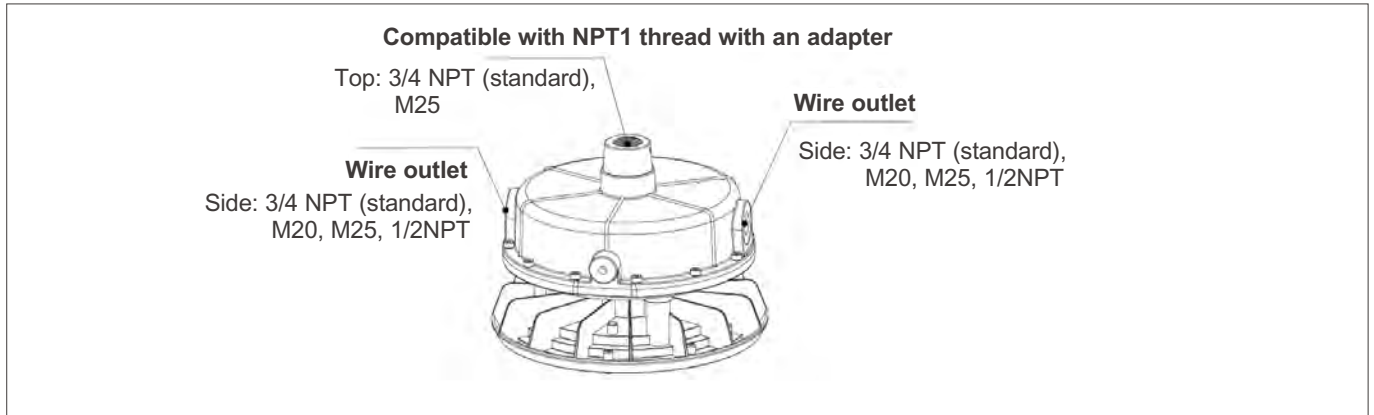

• Packing Information

Model	Net Weight*	Gross Weight*	Quantity/Carton	Package Dimensions (LxWxH)
B2	7.72 lb	11.02 lb	1 pc	14.17x13.94x10.24inch
B	9.70 lb	12.13 lb	1 pc	15.19x12.99x8.66inch
B3	18.08 lb	23.15 lb	1 pc	18.90x18.11x10.43inch
B4	37.48 lb	42.99 lb	1 pc	22.52x22.52x11.46inch

*Please note that net weight and gross weight may be subject to change because of actual configuration.

Ordering Guide

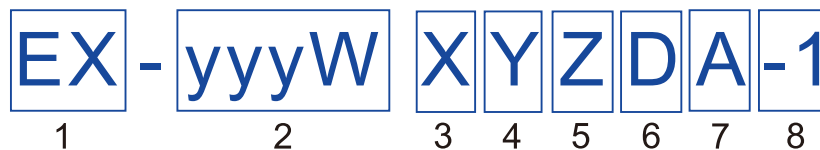

1. Product Categories	2. Wattage	3. Shell Shape Series	4. Dimming or Not
Explosion Proof Light	B2: 20/40W B: 60/80W B3: 100/120/150/200W B4: 250/300/350/400W	“X” Can be: B B2 B3 B4	“Y” Can be: D: Dimmable N: Non-dimmable

5. Color Temp.	6. Beam Angle	7. Long Glass Cover Option	8. Optional
“Z” can be 27 to 70 denotes 2700K to 7000K	D40=40° D60=60° D90=90° D120=120°	“A” = C: long glass cover blank: non long glass cover	“-1” NA (optional)

Photometric

40 Degree

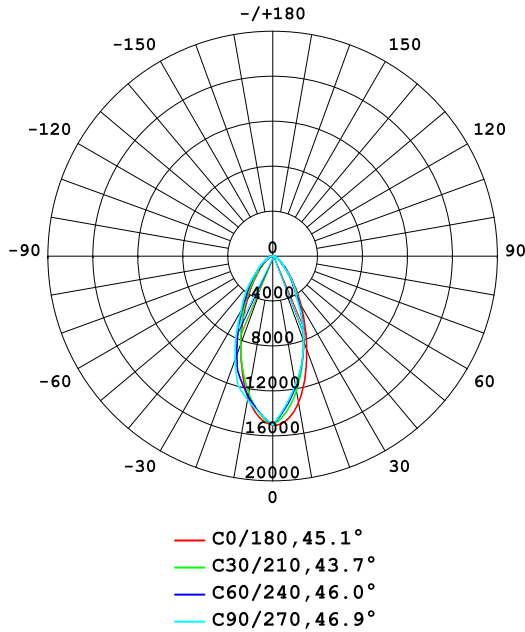

60 Degree

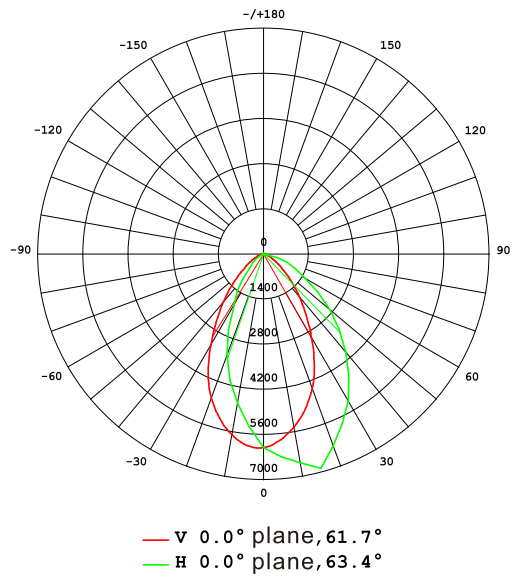

90 Degree

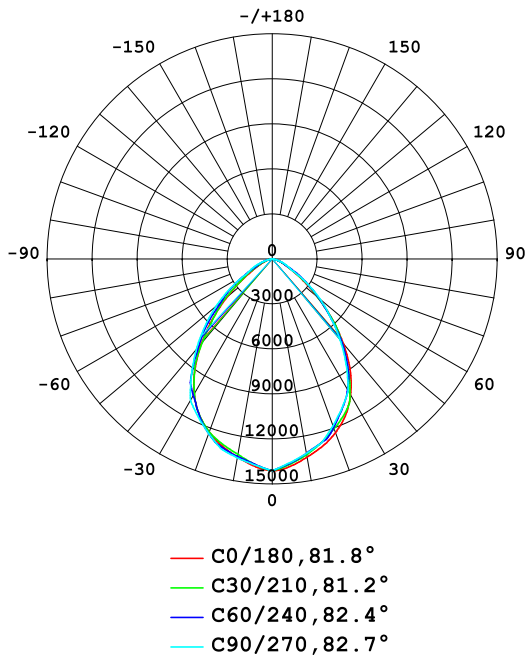

120 Degree

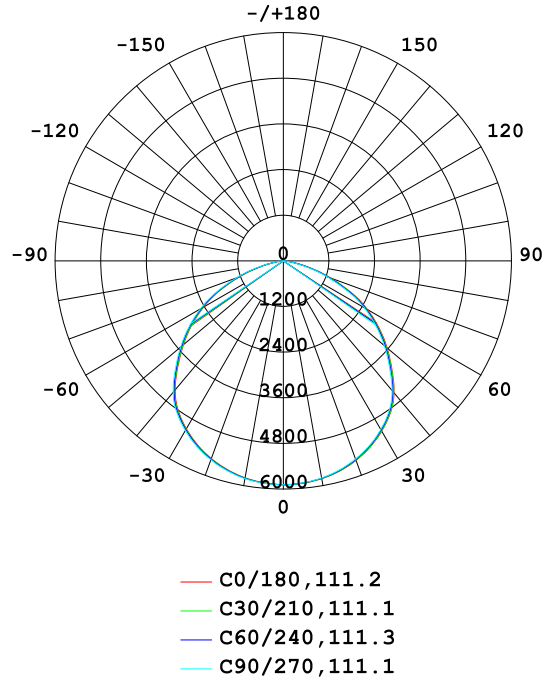

Mounting Methods

• Option 1: Ceiling Mounting

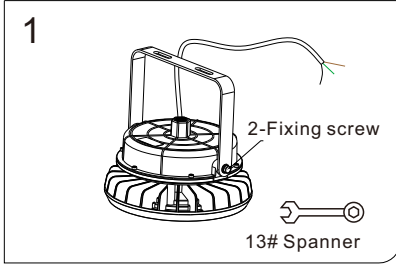

1. Take the fixture and accessory out from carton box, tighten 2x angle holder screw as Fig.1.

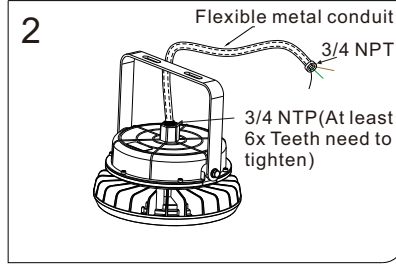

2. Install and tighten flexible metal conduit with the fixture.

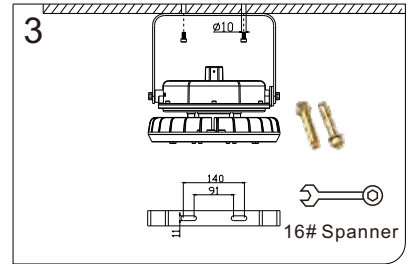

3. Drill 2x hole as shown in Fig.2, the distance can be 91~140mm, fixing $\varnothing 10$ expansion crews and bracket on ceiling.

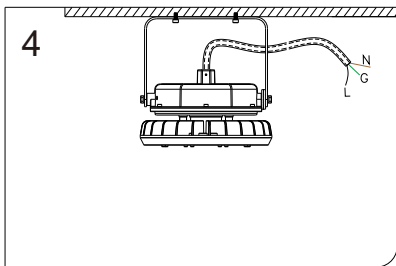

4. Connect black cable to L, white to N, green to grounding.

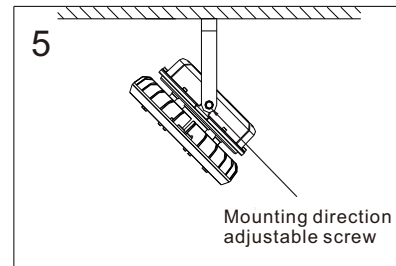

5. Adjust the beam angle from 0-180°.

• Option 2: Wall Mounting

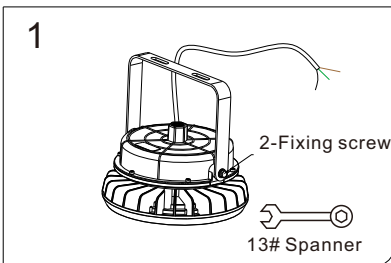

1. Take the fixture and accessory out from carton box, tighten 2x angle holder screw as Fig.1.

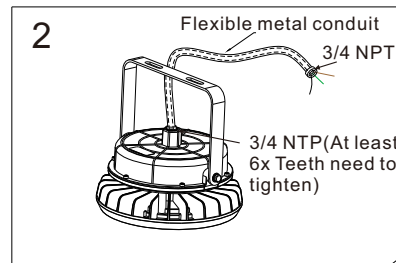

2. Install and tighten flexible metal conduit with the fixture.

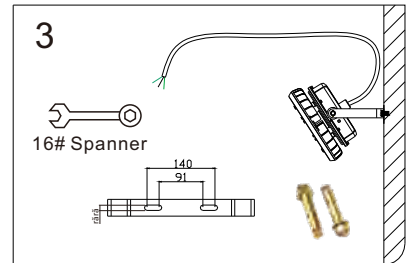

3. Drill 2x hole as shown in Fig.2, the distance can be 91~140mm, fixing $\varnothing 10$ expansion crews and bracket on ceiling.

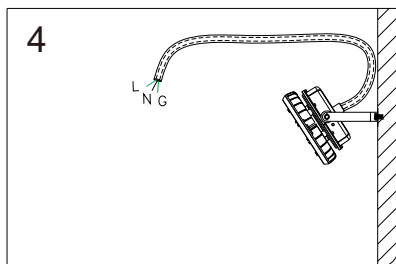

4. Connect black cable to L, white to N, green to grounding.

Mounting Methods

• Option 3: Pole Pendant Mounting

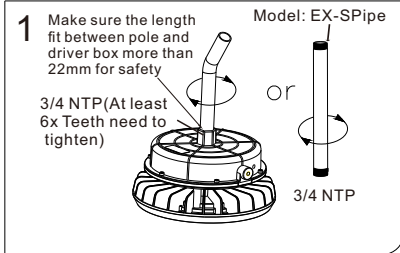

1. Take the fixture and pole accessory out from carton box, tighten pole as shown in Fig.1.

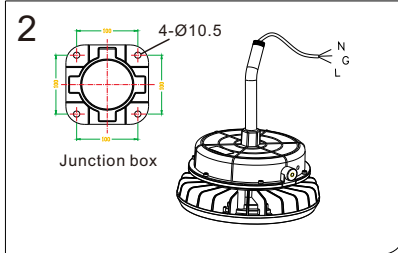

2. Connect black cable to L, white to N, green to grounding.

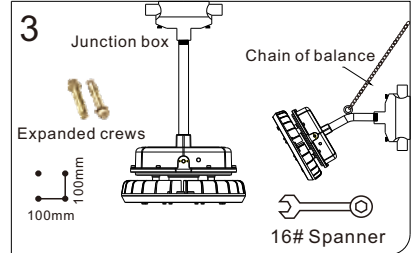

3. Drill 4x Ø10mm holes, as 100mm distance, install the junction box to the wall or ceiling as shown in Fig.3, tighten the pole to the box, and adjust the chain of balance.

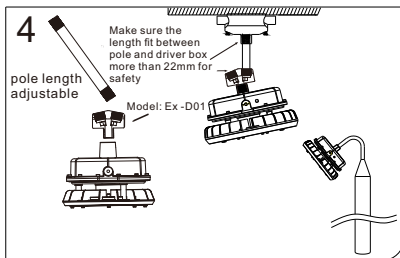

4. Adjustable pole installation. With this adjustable kit, make any light distribution direct as needed. Optional: install the fixture to the long pole after cable connecting.

• Option 4: Hook Pendant Mounting

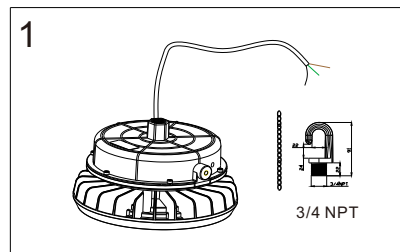

1. Take the fixture and accessory out from carton box, tighten 2x angle holder screw as Fig.1.

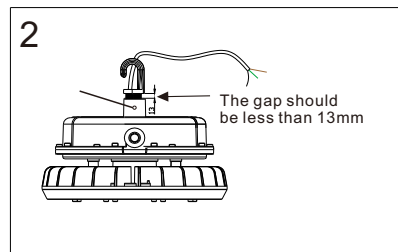

2. Tighten the hook with the fixture, at least 6x teeth need to be tightened, fix the M3 screw to prevent the hook from loosening.

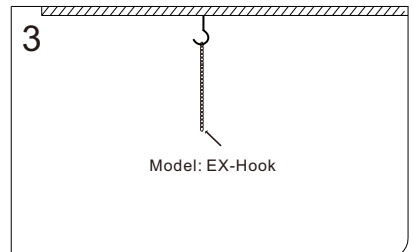

3. Drill 1 expansion screw hole and install it, and hang the chain as shown in Fig.3.

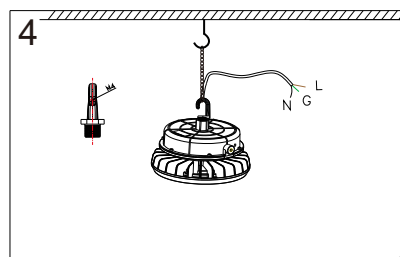

4. Connect black cable to L, white to N, green to grounding.

Mounting Methods

• Option 5: Ceiling Mounting by Opening Driver Box

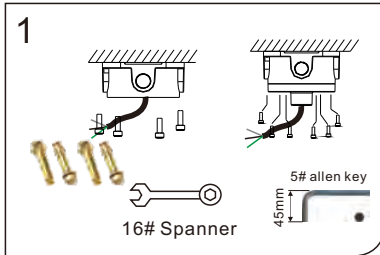

1. Take the fixture and pole accessory out from carton box, tighten pole as shown in Fig.1.

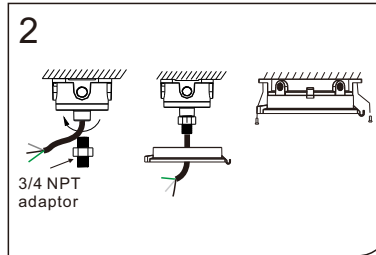

2. Install the 3/4" NPT adaptor through the cable to the hole of adaptor, tighten the driver enclosure cover to adaptor via M4 screw to prevent loosening.

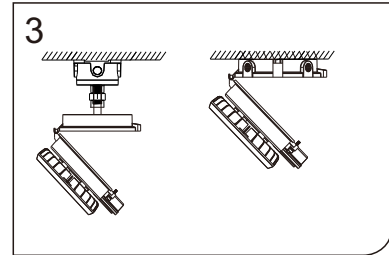

3. Connect black cable to L, white to N, green to grounding.

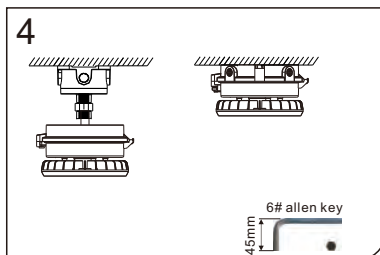

4. Tighten 3x M8 screws for driver enclosure as shown above.

• Option 6: Arm Mounting by Opening Driver Box (1)

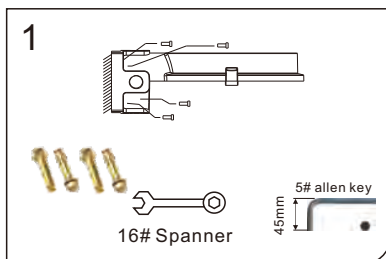

1. Install the 3/4" NPT adaptor through the cable to the hole of adaptor, tighten the driver enclosure cover to adaptor via M4 screw to prevent loosening.

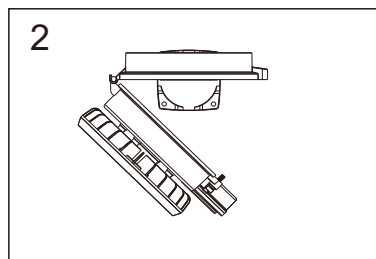

2. Hang the luminaire to the back cover.

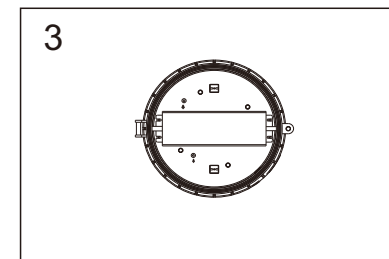

3. Connect black cable to L, white to N, green to grounding.

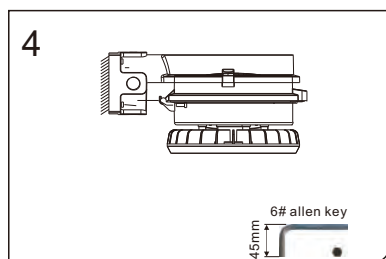

4. Tighten 3x M8 screws for driver enclosure as shown above.

Mounting Methods

• Option 7: Arm Mounting by Opening Driver Box (2)

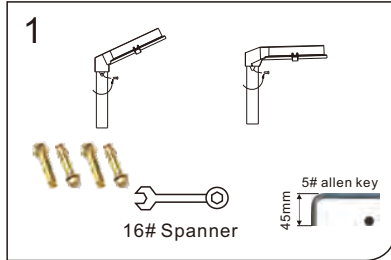

1. Install the 3/4" NPT adapter through the cable to the hole of adaptor, tighten the driver enclosure cover to adaptor via M4 screw to prevent loosening.

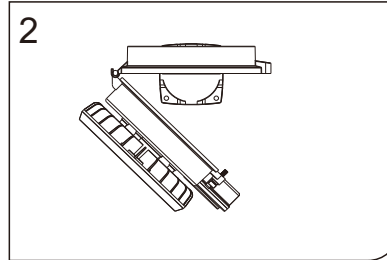

2. Hang the luminaire to the back cover.

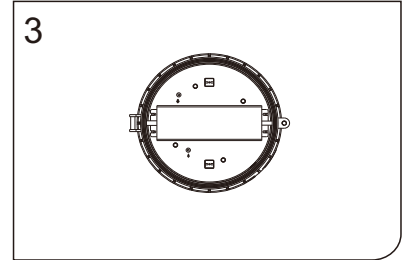

3. Connect black cable to L, white to N, green to grounding.

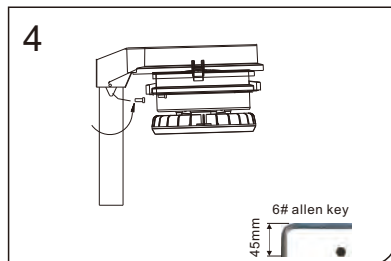

4. Tighten 3x M8 screws for driver enclosure as shown above.

• Option 8: Stanchion Mounting

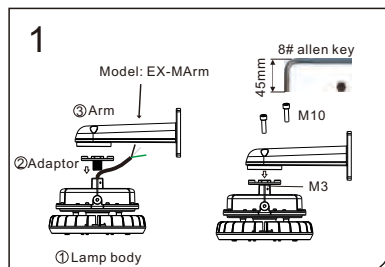

1. Tighten part 2 and assembly 1, fix the M3 screw, install arm to the adaptor, tighten the M10 via 8# allen key.

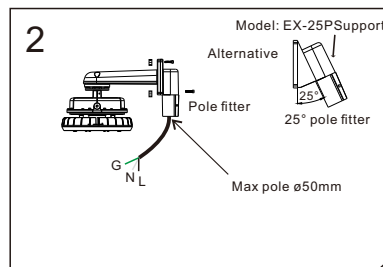

2. Install the pole fitter with arm via 4x M8 screws, the max suitable pole diameter 50mm, the alternative 25° pole fitter.

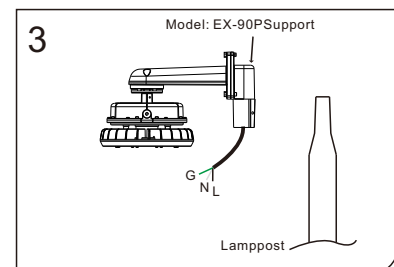

3. Connect the cable to AC wire, black connects to live wire, white to null wire, green to grounding.

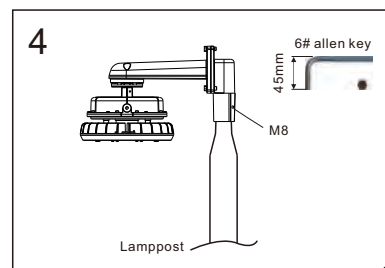

4. Slip the fitter to the lamppost and tighten M8 inner hexagonal screw.

Mounting Methods

Option 9: Wall Mounting to Junction Box

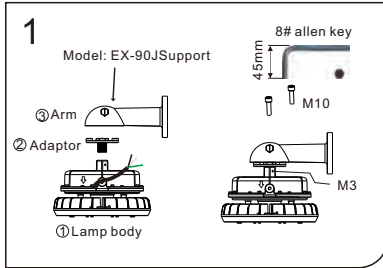

1. Tighten part 2 and assembly 1, fix the M3 screw, install arm to the adaptor, tighten the M10 via 8# allen key.

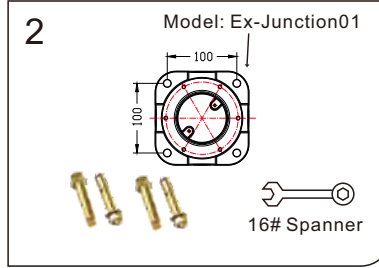

2. Drill 4x 10mm holes. Install the junction box to the wall via M10 expanded screw.

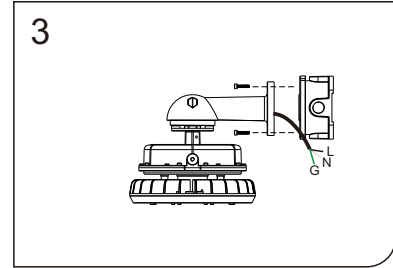



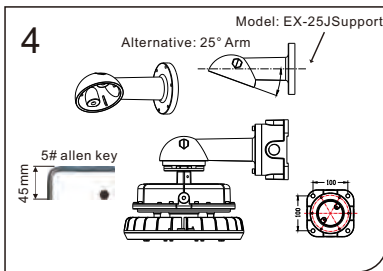











3. Connect the AC wire to power system, black to Live wire, white to Null wire, green to grounding.



4. Tighten 6x screws between arm and junction box, turn on the power to test the luminaires work.

Accessories

	Pole Ex-Straight Pipe		Hook Ex-Hook		Pendant Chain Ex-Straight Chain
	Pole Ex-Bended Pipe		Flexible Tube EX-NG		Bracket
	Junction Box EX-HD51-KB1		Pendant Direction Adapter		Stanchion Arm Ex-MArm
	Stanchion Arm EX-HD51-KYD 90		Pole Support Ex-25P Support		Cut-off Lamp Shade
	Stanchion Arm EX-HD51-KYD 25		Pole Support Ex-90P Support		Lamp Shade