

CRLC SERIES COMMERCIAL INDOOR LIGHTING

WESTGATE
THE FUTURE IS HERE...AND IT'S QUITE BRIGHT!

CRLC6-15W-MCT-S-D
CRLC6-15W-MCT-S-D-WH
6" LED COMMERCIAL SQUARE & OPEN RECESSED LIGHT



Ideal for hotel, offices, retail outlets, restaurant, parking garages, conference room, education facilities and more.

Customer Name: _____

Project Name: _____

Note: _____ Type: _____

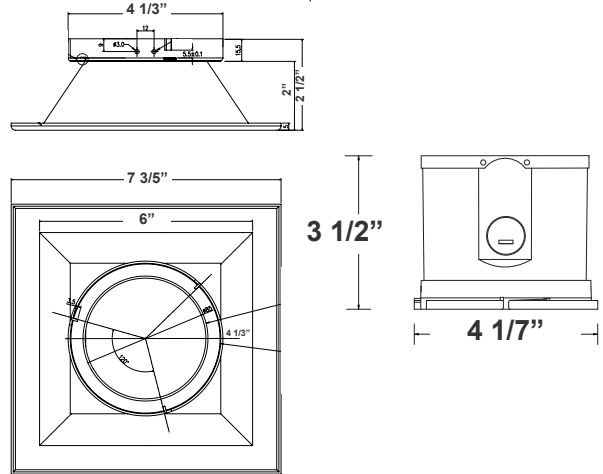

6"(H) X 4 1/7" (W)

Features

- 6" Haze & White Finish TRIM
- MCT: The Switch Is On The Light Engine
- Mounting Options: Recessed
- 5-Year Warranty
- Lifespan: 50,000 hrs.

Technical Specifications

Electrical:

- Voltage: 120-277VAC
50/60Hz
- Wattage: 15W
- Power Factor: >0.90
- Efficacy: 85 LPW

Mechanical:

- 6" Haze & White Finish TRIM
- Mounting Options: Recessed
- Temperature Rating: Designed To Operate in Temperatures 113°F
- Housing Not Required. Two Spring Clips To Hold The Fixture In Place
- No IC-Rated
- Suitable For Damp Locations
- 5-Year Warranty

Lighting:

- MCT: The Switch Is On The Light Engine
- Dimming: 0~10V Dimmable
- Total lumens: 1275LM
- Color Temperature: 3000K/4000K/5000K
- Color Rendering index: >80
- Lifespan: 50,000 hrs.

Applications:

- Ideal for hotel, offices, retail outlets, restaurant, parking garages, conference room, education facilities and more.

Other Models:

- 20W | 1720LM | CRLC6-20W-MCT-S-D
- 20W | 1720LM | CRLC6-20W-MCT-S-D-WH



Phone: (877) 805-2252 | Fax: (877) 805-2252
www.westgatemfg.com



Photometrics: CRLC6-15W-MCT-S-D

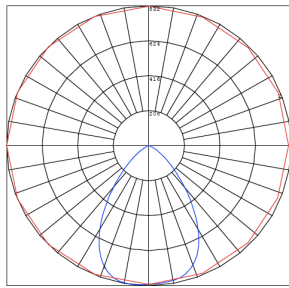
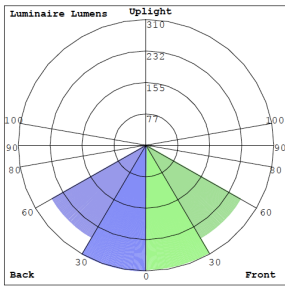

BUG Rating: B1-U1-G0

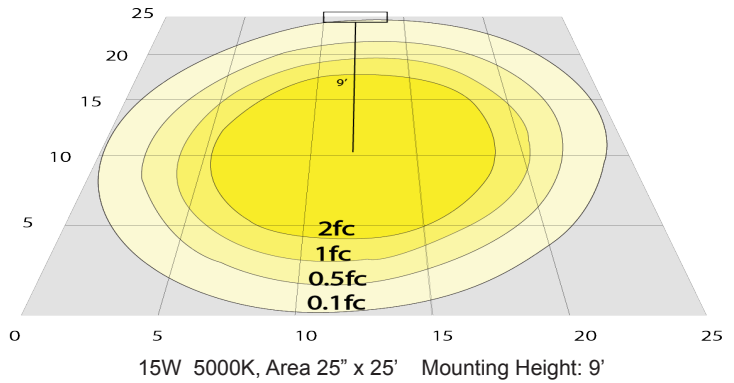

15W 5000K, Area 25" x 25" Mounting Height: 9'

Other Views:

Hazel



CRLC-EGN-15W-MCT-D

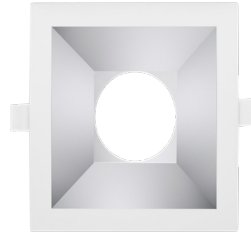

CRLC-TRM-6S



CRLC6-15W-MCT-S-D

White



CRLC-EGN-15W-MCT-D

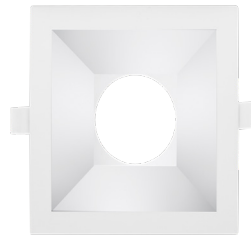

CRLC-TRM-6S-WH



CRLC6-15W-MCT-S-D-WH

Performance Table: CRLC4-15W-MCT-S-D

MODEL NO.	Wattage	Voltage	Lumens	Color Temp.	BUG Rating	LPW
CRLC6-15W-MCT-S-D	15W	120-277V	1275LM	3000K	B1-U1-G0	85
CRLC6-15W-MCT-S-D-WH				4000K		
				5000K		

Sample Ordering

Model Watt Shape Dimming Housing

CRLC6 - 15W - MCT - S - D -

Blank
WH = WHITE

Accessory:

Blank = No Option For Accessories
SSL6-RI = 6" SQUARE ROUGH-IN PLATE, 26" LONG

Factory-Installed Option:

Blank = No Option For Accessories
OPT-EM-HB1EXT = EXTERNAL EMERGENCY BACK UP BATTERY

Accessory:

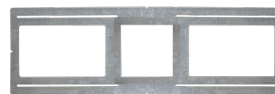

SSL6-RI
6" SQUARE ROUGH-IN
PLATE, 26" LONG

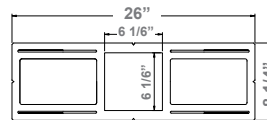

SSL6-RI
26"(W) x 8 1/4"(H)

Factory-Installed Option:



OPT-EM-HB1EXT
EXTERNAL EMERGENCY
BACK UP BATTERY

Example:

1. CRLC6-15W-MCT-S-D (FOR 15W CRLC6 MCT 120-277V)

1. CRLC6-15W-MCT-S-D (FOR 15W CRLC6 MCT 120-277V)
OPT-EM-HB1EXT (EXTERNAL EMERGENCY BACK UP BATTERY)

