

# LED COMPASS HIGH BAY - 100-277V

## INSTALL INSTRUCTIONS



**PLEASE FIND A QUALIFIED ELECTRICIAN FOR INSTALLATION.** Please read the instructions before you install and use the luminaire.

### WARNING, CAUTIONS AND OPERATING INSTRUCTIONS

- To reduce the risk of death, personal injury or property damage from fire, electric shock, falling parts, cuts/abrasions, and other hazards read all warnings and instructions included with and on the fixture box and all fixture labels.
- Before installing, servicing, or performing routine maintenance upon this equipment, follow these general precautions.
- Commercial installation, service and maintenance of luminaires should be performed by a qualified licensed electrician.
- For the installation: If you are unsure about the installation or maintenance of the luminaires, consult a qualified licensed electrician and check your local electrical code.
- To prevent wiring damage or abrasion, do not expose wiring to edges of sheet metal or other sharp objects.
- Do not make or alter any open holes in an enclosure of wiring or electrical components during kit installation.

### WARNING: RISK OF FIRE OR ELECTRICAL SHOCK

- Turn off electrical power at fuse or circuit breaker box before wiring fixture to the power supply.
- Turn off the power when you perform any maintenance.
- Verify that supply voltage is correct by comparing it with the luminaire label information.
- Make all electrical and grounded connections in accordance with the National Electrical Code and any applicable local code requirements.
- All wiring connections should be capped with UL approved wire connectors.

### CAUTION: RISK OF INJURY

- Avoid direct eye exposure to the light source while it is on.
- Account for small parts and destroy packing material, as these may be hazardous to children.
- The external flexible cable or cord of this luminaire cannot be replaced.
- Mounting surface should be of sufficient strength to hold more than the weight of the fixture.
- Suitable for Wet locations.

**! WARNING DISCONNECT POWER BEFORE INSTALLING OR SERVICING.**

### GENERAL WIRING DIAGRAM

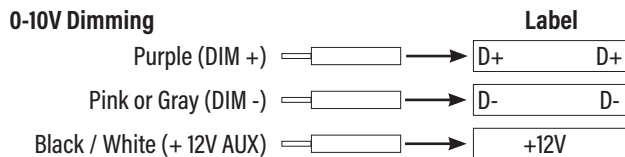
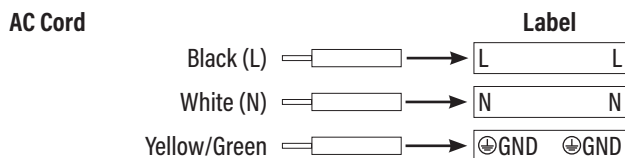

*\*Note: For non-dimming applications, cap the purple and pink (or gray) dimming wires separately. Failure to do so may cause malfunctioning and void warranty. • 12V DC AUX wire must be capped if unused.*

### SAFETY CABLE

(Not included, must be provided by installer.)

100W-400W

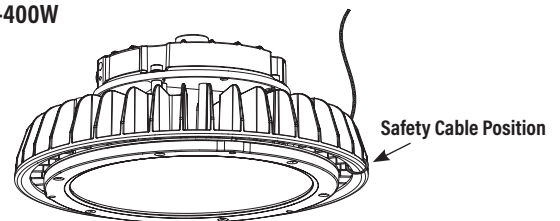

500W-600W

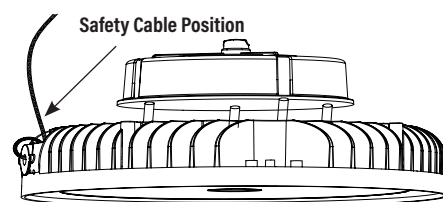

# LED COMPASS HIGH BAY - 100-277V

## INSTALL INSTRUCTIONS

**! WARNING** DISCONNECT POWER BEFORE INSTALLING OR SERVICING.

### EYELET INSTALLATION

For: 100W / 150W / 200W  
240W / 300W / 400W

1. Drill a hole into the ceiling for the appropriate size hook (provided by installer).
2. Secure hook to the ceiling and hang the fixture from the hook.
3. Install safety cable and secure fixture to it (safety cable provided by installer).
4. Connect the electrical cables (see general wiring diagram). If using in wet locations, ensure all electrical connections and installation holes have a water tight seal.

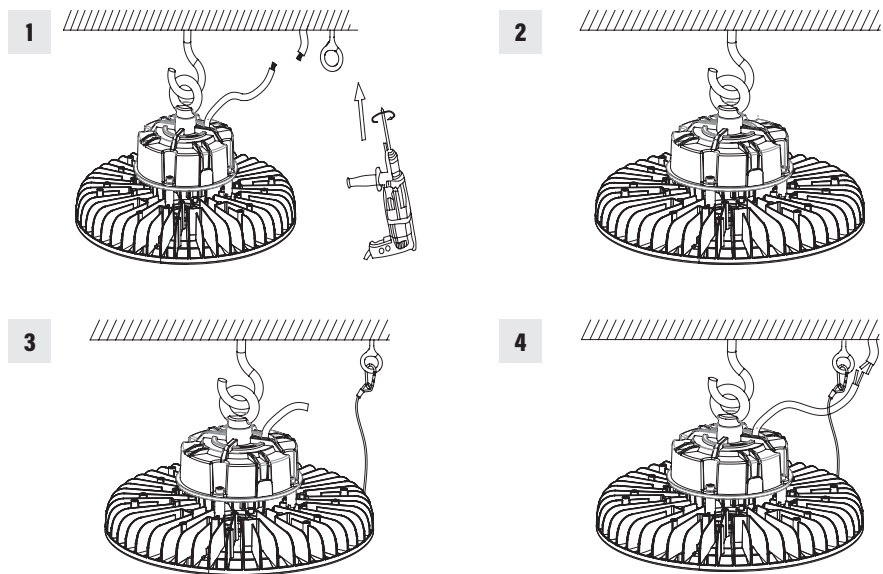

### BRACKET INSTALLATION

Bracket included: 500W / 600W  
(Bracket sold separately for 100W-400W)

1. Drill a hole into the ceiling and install expansion screws (provided by installer).
2. Attach the bracket to the mounting surface.
3. Install safety cable and secure fixture to it (safety cable provided by installer).
4. Connect the electrical cables (see general wiring diagram). If using in wet locations, ensure all electrical connections and installation holes have a water tight seal.

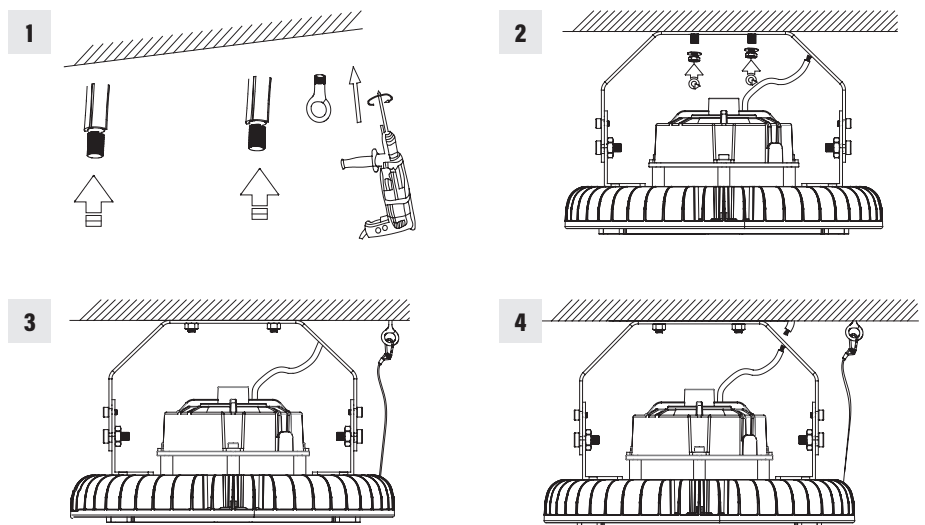

### BRACKET MOUNTING DIAGRAM

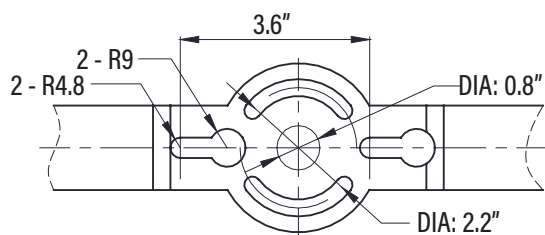

100W / 150W / 200W / 240W / 300W / 400W

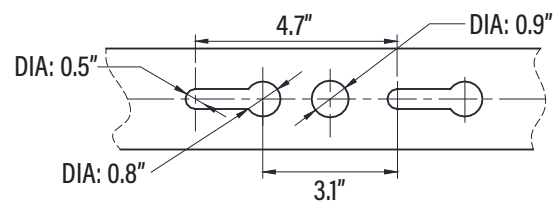

500W / 600W