

SPARK PRO™

Solar Sign Light

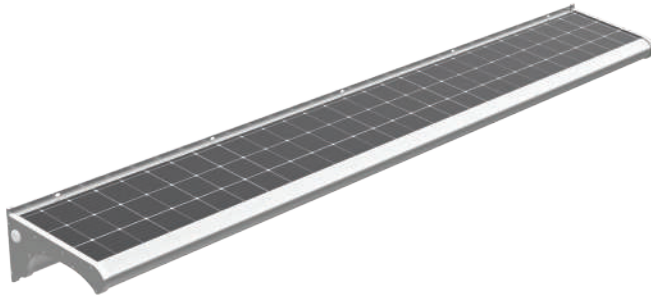

The Spark Pro Solar Sign Light features bright, clear lighting to make your signage lighting easily viewable to the public so even through the night, you can feel secure in knowing your billboards will still be seen. Modern, revolutionary design features a LCD display screen to conveniently show you the power consumption. Durable and aesthetically beautiful crystalline, air-plane grade aluminum material and OSRAM LED chip.



- Crystalline Solar Panel with 90 degree tilted angle design. Harvest double the energy compared to horizontal panels
- Built-in tempered glass solar panel, designed to offer self-cleaning operation between rainy and sunny days
- Attached brackets design for thick boards installation and extended arms for thin boards mounting
- Easy to change modular battery pack for further lifespan extension
- OSRAM LED chips for commercial-grade performance
- LCD screen conveniently displays Power Consumption
- 4 hours 100% brightness, +25% brightness until dawn
- 800-2500 Lumens and IP65 Rated
- 2 Years limited warranty

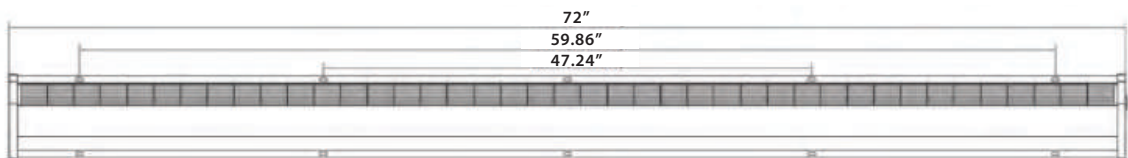
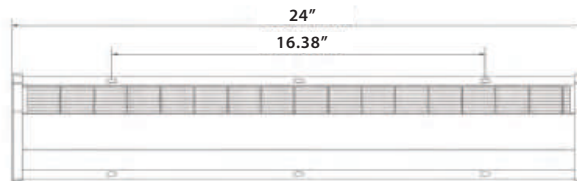
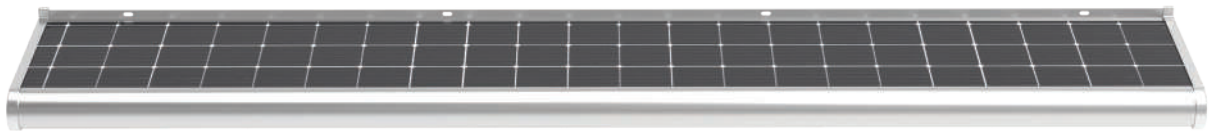

SPARK PRO™

Solar Sign Light

Specifications

Model #	SKU #	Power	PV Type	Solar Panel	CCT	Lumens	Working Time (Hrs)	IP Rating
AVS-TPRO-800	990204	4W	Mono	12V	5000k	800LM	3-4 Hours	IP65
AVS-TPRO-2500	990205	12.5W	Mono	12V	5000k	2500LM	3-4 Hours	IP65

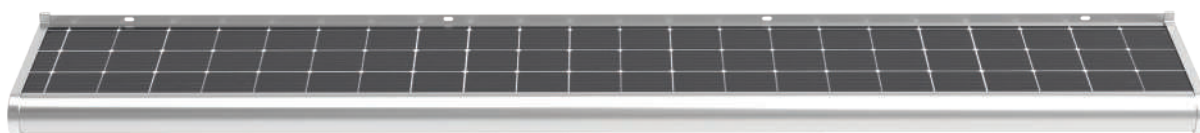

Features

- IP65 Rated
- Completely Solar Powered, No Wiring

Advantages

- Quick, easy installation
- Air-plane grade aluminum

Applications

- Areas with no electrical supply
- Main Roadways and Avenues
- Perimeter & Pathway Lighting

SOLAR TRIANGLE LIGHT		SOLAR TRIANGLE LIGHT	
Model No.	AVS-TPRO-800	Model No.	AVS-TPRO-2500
Wattage	4W	Wattage	12.5W
IP Rating	IP65	IP Rating	IP65
Battery	7.4V 5.2AH	Battery	7.4V 5.2AH
Lumens	800LM Max	Lumens	2500LM Max
Surface Colors	Aluminum+PC	Surface Colors	Aluminum+PC
Total Dimensions	L24" X W8.13" X H4.71"	Total Dimensions	L72" X W8.13" X H4.71"
Ideal Info Board	150CMX300CM	Ideal Info Board	150CMX300CM
Solar Panel	Crystalline 5.SV 17W	Solar Panel	Crystalline 5.SV 17W
Working Mode	First 4 hours 100% brightness + 25% brightness until dawn	Working Mode	First 4 hours 100% brightness + 25% brightness until dawn

Correlated Color Temperature

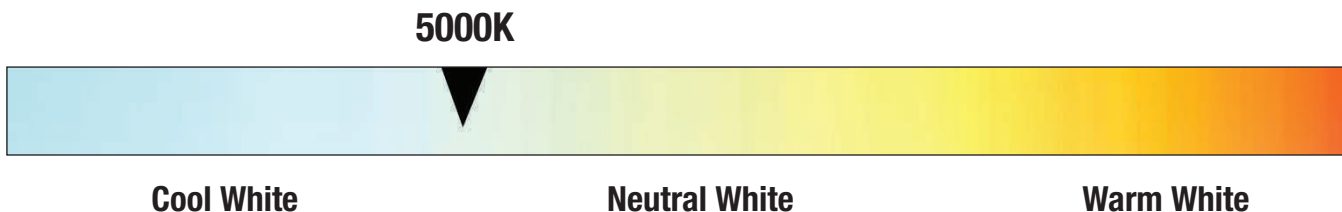

SPARK PRO™

Solar Sign Light

Installation

Solar Sign Light

1. PACKAGE CONTENTS

- | | |
|---|---------|
| 1. Solar Panel and Battery with LED array | 1 piece |
| 2. Screws | 4pieces |
| 3. Instruction sheet | 1 piece |

2. APPLICATIONS

- Garden Fence
- Billboard/Sign
- Sculpture/Memorial
- Pathway
- Sign Boards
- Wall Washer
- Traffic Sign

3. FEATURES

- Easy installation-No electrical wiring required with integrated design.
- Turn on automatically at night and off during the day.
- The lights include an ON/OFF switch and built-in battery
- Battery can support 2-3 days with cloudy days.
- When the battery is full charged in sunlight,the lights will operate up to 3 nights.
- ASW3.0 intelligent power saving mode increases lighting X 1.5 times.
- IP65 water and dust resistance
- Anti-glare shield design to make signage brighter and environmental friendly.

5. INSTALL INSTRUCTIONS

Please read these instructions before installation to be ensure optimum results and longevity of your lights. The solar panel should be charged in full sunlight for 6 to 8 hours before first use to obtain optimum results.



SPARK PRO™

Solar Sign Light

Installation

Solar Sign Light

Wall Mount

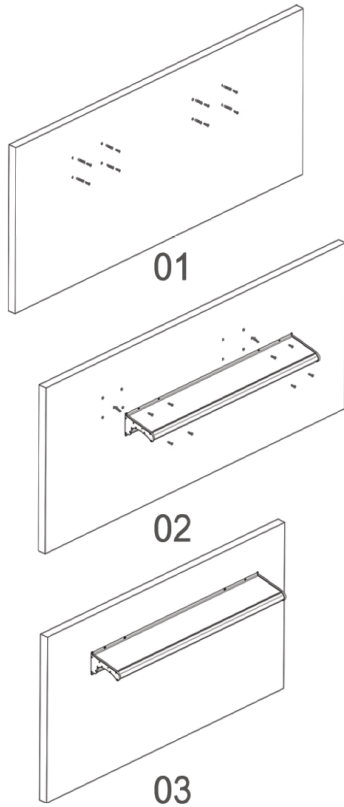

Clamp Mount

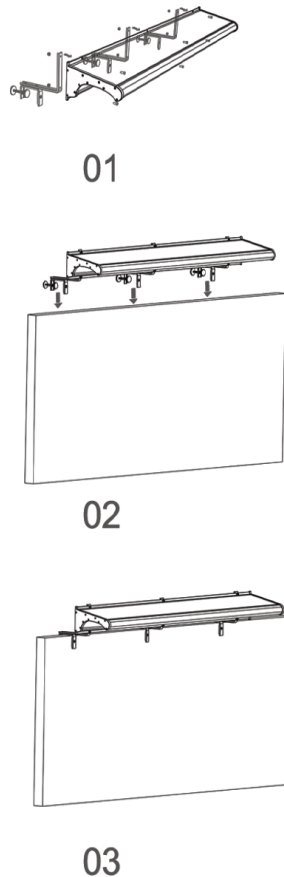

T-bracket Mount

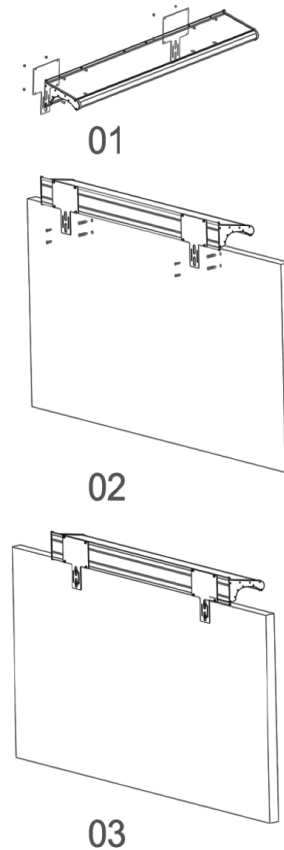

Clamp Mount(Long Arm Bracket)

You are recommended to use 2 pcs long arm bracket for RX-STARP-30/60, 3pcs for RX-STARP-90/120, 4pcs for RX-STARP-150/180. Lamp arm brackets are not included in package you have to contact with our salesperson.

T-bracket Mount

You are recommended to use 1 pc T-bracket for RX-STARP-30, 2pcs for RX-STARP-60/90, 3pcs for RX-STARP-120/150, 4pcs for RX-STARP-180. T-brackets are not included in package, you have to contact with our salesperson.



SPARK PRO™

Solar Sign Light

Product Design and Benefits

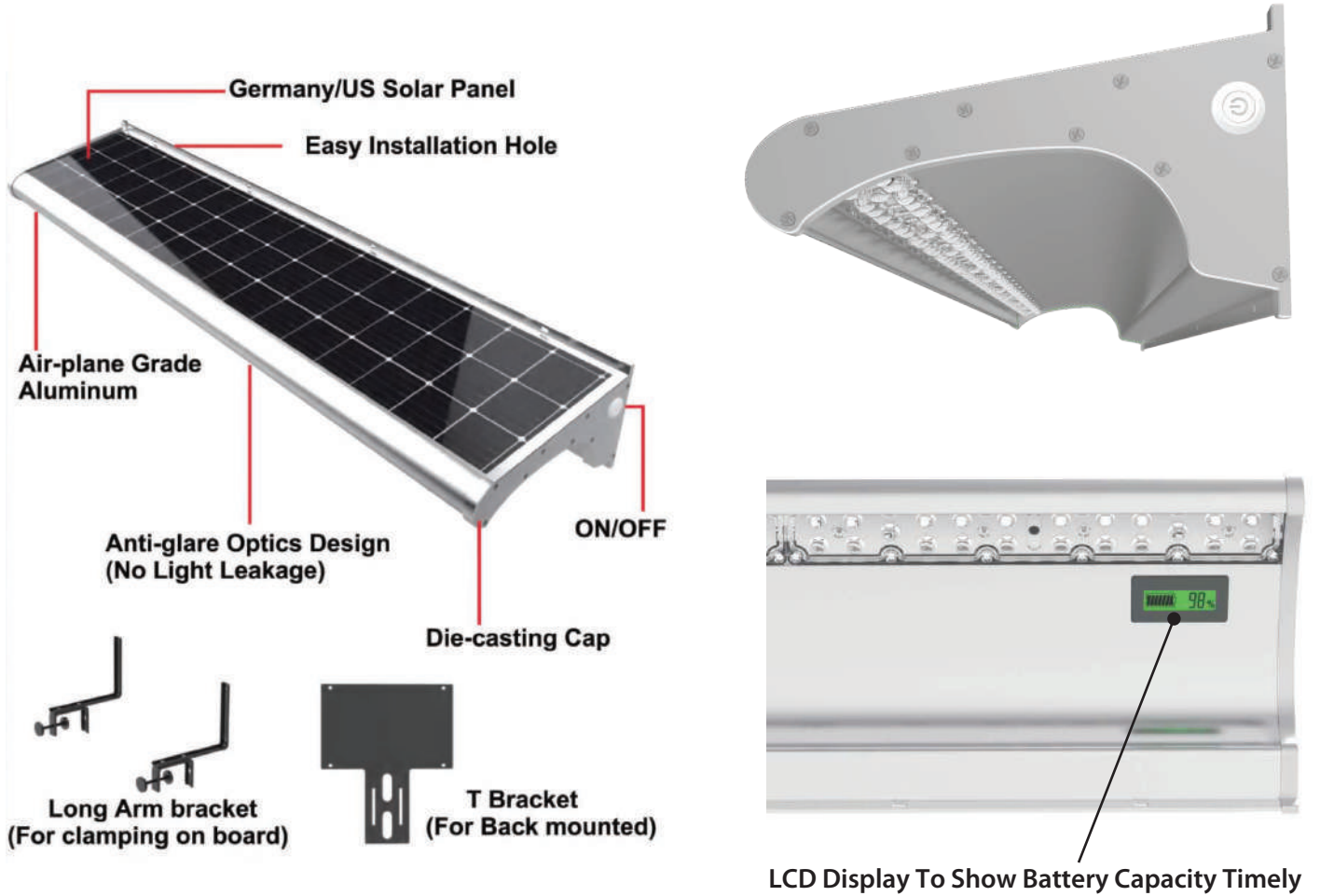

SPARK PRO™

Solar Sign Light

Three Installation Methods

2. Back T- Bracket Monnted

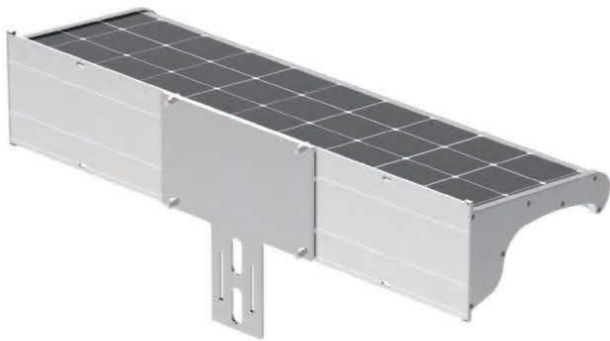

1. Surface Mounted



3. Clamp Mounted



SPARK PRO™

Solar Sign Light

Anti-Glare For Traffic Safety
365 Days Working
24" / 30" / 36" Octagon Stop



Corner Store



SPARK PRO™

Solar Sign Light

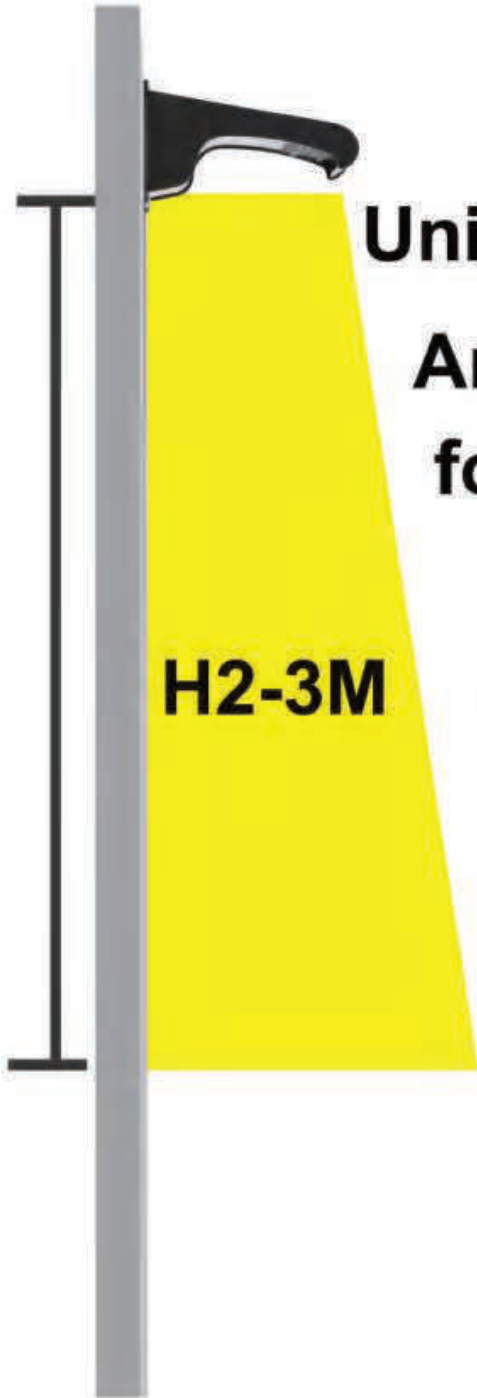

Unique optical lens 90°
Anti-glare shield
for pedestrian and driver



SOLAR SIGN LIGHT

